

htc

User guide _____



HTC One X9 dual sim

Contents

Features you'll enjoy

Android 6.0 Marshmallow	8
Imaging	9
Sound	10
Personalization	11
HTC app updates	12

Unboxing

HTC One X9	13
Dual nano SIM cards	14
Storage card	15
Charging the battery	17
Switching the power on or off	17
Want some quick guidance on your phone?	18

Phone setup and transfer

Setting up HTC One X9 for the first time	19
Restoring from your previous HTC phone	19
Transferring content from an Android phone	20
Ways of transferring content from an iPhone	21
Transferring iPhone content through iCloud	21
Other ways of getting contacts and other content	21
Transferring photos, videos, and music between your phone and computer	22
Using Quick Settings	22
Getting to know your settings	23
Updating your phone's software	23
Getting apps from Google Play	25
Downloading apps from the web	26
Uninstalling an app	27

Your first week with your new phone

Basics	28
HTC Sense Home widget	35
Motion Launch	37
Lock screen	40
Notifications	43
Working with text	44
HTC Help	48

Personalizing

Themes	49
More ways to personalize	52

HTC BlinkFeed

What is HTC BlinkFeed?	59
Turning HTC BlinkFeed on or off	60
Restaurant recommendations	60
Ways of adding content on HTC BlinkFeed	61
Customizing the Highlights feed	63
Posting to your social networks	63
Removing content from HTC BlinkFeed	63

Camera

Camera basics	64
Selfies and people shots	69
Zoe camera	71
Panoramic shots	71
Hyperlapse	72
Pro mode	72

Gallery

Viewing photos and videos in Gallery	74
Adding photos or videos to an album	75
Copying or moving photos or videos between albums	76
Searching for photos and videos	76
Changing the video playback speed	76
Viewing Zoe photos in Gallery	77
Trimming a video	77
Editing a Hyperlapse video	78
Viewing, editing, and saving a Zoe highlight	78

Photo Editor

Basics	79
Editing continuous shots	81
Creative effects	82
RAW photos	87

Phone calls

Phone calls	88
-------------	----

Messages

Sending a text message (SMS)	94
Sending a multimedia message (MMS)	94
Sending a group message	95
Resuming a draft message	95
Replying to a message	95
Forwarding a message	96
Moving messages to the secure box	96
Blocking unwanted messages	97
Copying a text message to the nano SIM card	97
Deleting messages and conversations	97

Power and storage management

Battery	99
Storage	102
File Manager	107

Sync, backup, and reset

Online sync	109
Backup	110
HTC Sync Manager	113
Reset	115

People

Your contacts list	117
Setting up your profile	118
Adding a new contact	118
Editing a contact's information	119
Getting in touch with a contact	120
Importing or copying contacts	120
Merging contact information	121
Sending contact information	122
Contact groups	122
Private contacts	123

Calendar and Email

Calendar	125
Mail	129

Google Search and apps

Google Now	134
Google Search	136
Google apps	138

Other apps

HTC Dot View	139
Clock	141
Weather	142
Voice recorder	142
FM Radio	143

Internet connections

Turning the data connection on or off	144
Managing your data usage	144
Wi-Fi connection	146
Connecting to VPN	147
Using HTC One X9 as a Wi-Fi hotspot	148
Sharing your phone's Internet connection by USB tethering	149

Wireless sharing

HTC Connect	150
Bluetooth	153
NFC	156

Settings and security

Toggle modes in HTC BoomSound	158
Using HTC BoomSound with headphones	158
Turning location services on or off	158
Do not disturb mode	159
Airplane mode	160
Automatic screen rotation	161
Setting when to turn off the screen	161
Screen brightness	161
Touch sounds and vibration	161
Changing the display language	162
Installing a digital certificate	162
Disabling an app	163
Controlling app permissions	163
Setting default apps	163
Setting up app links	163
Managing your nano SIM cards with Dual network manager	164
Assigning a PIN to a nano SIM card	164
Accessibility features	165
Accessibility settings	166
Turning Magnification gestures on or off	166
Navigating HTC One X9 with TalkBack	166

Trademarks and copyrights

Index

About this guide

In this user guide, we use the following symbols to indicate useful and important information:



This is a note. A note often gives additional information, such as what happens when you choose to do or not to do a certain action. A note also provides information that may only be applicable to some situations.



This is a tip. A tip gives you an alternative way to do a particular step or procedure, or lets you know of an option that you may find helpful.



This indicates important information that you need in order to accomplish a certain task or to get a feature to work properly.



This provides safety precaution information, that is, information that you need to be careful about to prevent potential problems.

Some apps may not be available in all regions or with your mobile operator.

Important note on recoverable data

Files and other data that have been deleted, cleared, removed, or erased from your device may still be recoverable by third-party data recovery software. Even a factory reset may not permanently erase all data from your mobile device, including personal information.

Features you'll enjoy

Android 6.0 Marshmallow

Android™ 6.0 Marshmallow brings new features that make your mobile life more convenient.

Now on Tap

Now on Tap intuitively searches and delivers related information right in the app. This means that you'll never have to leave the conversation or the website you're browsing to search for information.

Just press and hold  and Now on Tap displays related information, apps, and actions. See [Now on Tap](#) on page 136.

Manage phone memory

Use Memory in Settings to monitor the average memory use and performance of HTC One X9. You can also use this setting to check which apps use the most memory.

Major change to how you use storage cards

If you have an existing storage card with media and other files, use it as removable storage so you can insert the card and access your files on any Android phone.

If you have a brand new storage card, you can use the card to expand the internal storage. See [Should I use the storage card as removable or internal storage?](#) on page 103 and [Setting up your storage card as internal storage](#) on page 103.

Network settings reset

Quickly reset all network settings when HTC One X9 has a hard time connecting to the mobile data or Wi-Fi® network or Bluetooth® device. See [Resetting network settings](#) on page 115.

Google settings

Easily manage settings for Google® apps and features on HTC One X9. Tap **Google** in Settings and change your preferences.

Smarter app linking

Android 6.0 Marshmallow automatically opens the correct app for links that you tap in a text or email message or website. With smarter app linking, there's no more guessing which app can handle the links you tap.

In Settings, you can change the default apps to link to. For details, see [Setting default apps](#) on page 163 and [Setting up app links](#) on page 163.

App permissions

To help protect your phone and privacy, Android 6.0 Marshmallow has improved the way apps are given access to certain data or features, such as contacts or the microphone. For details, see [Controlling app permissions](#) on page 163.

Imaging

Made to help you capture your memories to share with family and friends.

RAW enhancement

With RAW image enhancement, you can take your photos to a whole new level. After snapping a shot in Pro mode, the camera saves a RAW file in DNG format. The RAW file provides more image information for post processing in Photo Editor or a graphics program on your computer. See [Taking a RAW photo](#) on page 73.

Hyperlapse

Compress a long video into a smooth, entertaining video. Hyperlapse lets you speed up the action up to 12 times, and select sections of the video to change its speed. See [Recording a Hyperlapse video](#) on page 72.

Anti-shake lens

Optical Image Stabilization (OIS) reduces blur from hand movements while you shoot. You'll get sharper, brighter photos with more clarity, even in low light.

Front camera features

Enjoy selfie-friendly features in the Camera app.

- Live Makeup – Before taking your selfie, use Live Makeup to smoothen your skin. See [Applying skin touch-ups with Live Makeup](#) on page 69.
- Instant selfie shots – Flash a smile, and the camera instantly captures your smiling face. Or, just say "Cheese!" See [Using Auto Selfie](#) on page 69 and [Using Voice Selfie](#) on page 70.

Photo Editor

The Photo Editor app enhances your photos, from basic edits to elegant effects!



Make a photo surreal. Blend in shapes, elements, and prismatic effects. See [Prismatic](#) on page 84.



Superimpose one image onto another and create a unique composition only you can imagine! See [Double Exposure](#) on page 85.

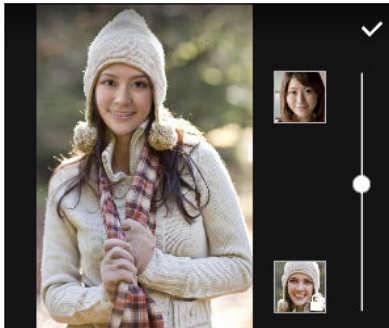

Face Fusion uses two photos such as your selfie and a photo of your favorite celebrity to merge your looks together. See [Face Fusion](#) on page 87.

Sound

Plug in headphones and discover audio bliss on HTC One X9. Easily connect wireless speakers to your phone.

HTC BoomSound with Dolby Audio

Hear what you've been missing. HTC BoomSound™ gives you a rich, authentic sound experience, whether you're listening to music, watching a video, or playing a game. To find out more, see [Using HTC BoomSound with headphones](#) on page 158.

HTC Connect

Simply swipe up the screen with three fingers to stream music or video from HTC One X9 to your speakers or TV. Control the volume and playback with your phone! You can even enjoy your favorite music on multiple speakers. See [What is HTC Connect?](#) on page 150.

Personalization

Designed with you in mind, HTC One X9 is filled with innovations that help it to adapt to your life.

Themes



Make HTC One X9 feel more personal by customizing how it looks with your own photos and then mix and match with different sets of icons, sounds, color schemes, and more. See [What is the Themes app?](#) on page 49.

HTC Sense Home

Your Home screen adapts to your needs at home, at work, and on the go. See [What is the HTC Sense Home widget?](#) on page 35.

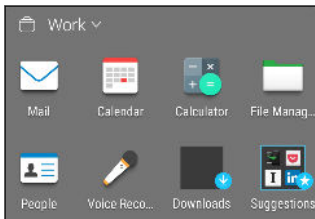

Lock screen notifications make it easier to find what you've missed, see upcoming events, and more. See [Turning lock screen notifications on or off](#) on page 41.

HTC BlinkFeed

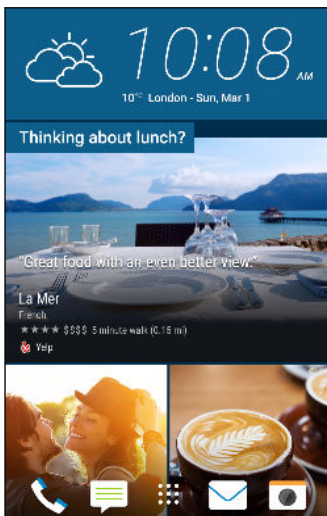

Get your favorite topics, news, social media, and more conveniently delivered to one place on your phone. Even get suggestions for places to eat! See [What is HTC BlinkFeed?](#) on page 59.

HTC app updates

From time to time, HTC adds or enhances features in apps such as HTC Sense™ Home, Camera, Gallery, and more. Download and install the latest updates of HTC and other apps from Google Play™ to enjoy the new and improved features. Some HTC apps that are not preloaded in certain phones can also be downloaded from Google Play.



The information in this guide may not be most up-to-date if there are more recent app updates available.

Unboxing

HTC One X9

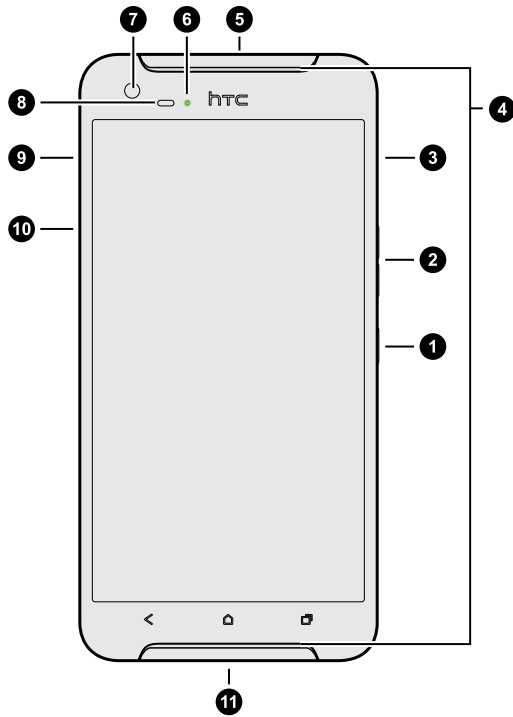

1. POWER
2. VOLUME buttons
3. nano SIM card slot
4. Dual speakers
5. 3.5mm headset jack
6. Notification LED
7. Front camera
8. Proximity sensor
9. nano SIM card slot
10. microSD™ card slot
11. USB connector



You need a 4G/LTE™ plan to use your operator's 4G/LTE network for voice calls and data services. Check with your operator for details.



- If you want to use a case or screen protector, don't cover and block the proximity sensor. Purchase a case or screen protector designed for HTC One X9.
- Avoid liquid or dust from entering the microphone hole to prevent damage to the microphone.
- Avoid connecting third-party headsets or accessories with metallic charms that dangle near the headset jack. Using these may affect signal reception.

Dual nano SIM cards

HTC One X9 has two nano SIM card slots. You can insert a LTE/WCDMA/GSM nano SIM card in either slot.

When you have two cards inserted, only one card can connect to a mobile data network. The other card will connect to the 2G network only. Go to **Settings > Dual network manager** to set which card connects to mobile data network.

Use a standard nano SIM card only. Inserting a modified card that is thicker than the standard nano SIM card may cause the card to not fit properly or damage the card slot.

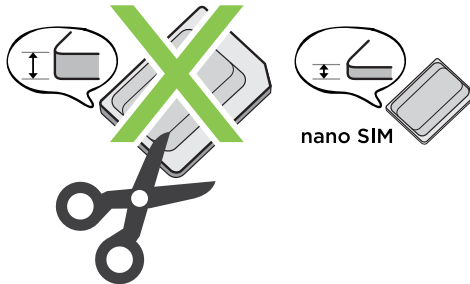

Inserting nano SIM cards

1. Make sure HTC One X9 is off and hold it securely with the front facing down.
2. Open the left slot cover with your thumb or finger.

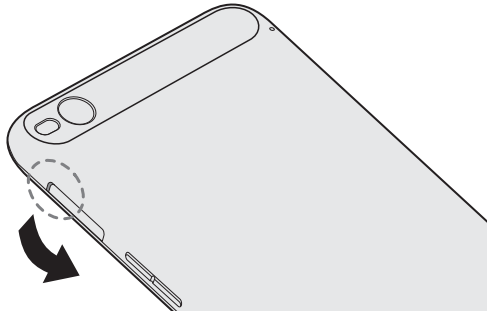

3. Pull the tray out from the nano SIM slot.
4. Place a nano SIM card into the tray with the card's gold contacts facing up and its cut-off corner facing out.

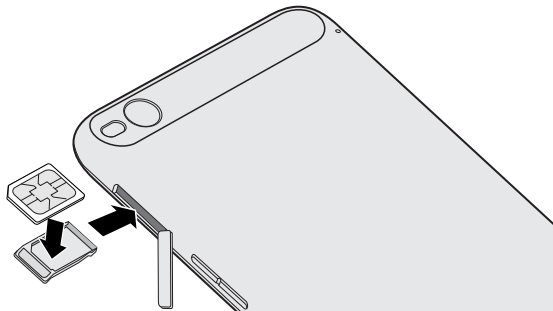

5. When reinserting the tray, make sure it is facing up so that the nano SIM card doesn't fall out. Slide the tray all the way into the slot.
6. Close the slot cover. Press from the top to the bottom of the slot cover to lock it in place.
7. Open the right slot cover, and do the same steps as above to insert your second nano SIM card in the tray that's in the SIM 2 slot.

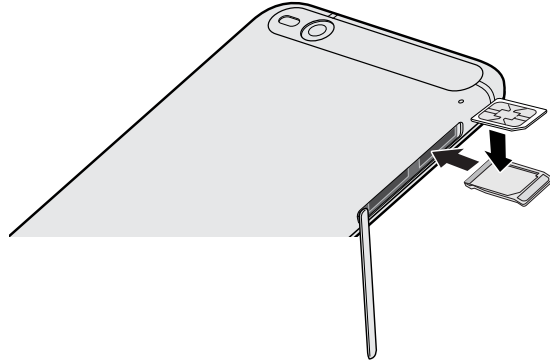

To close the right slot cover, slide the plastic hinge into the side and press the cover until it clicks into place.

Removing a nano SIM card



Make sure to switch off HTC One X9 before removing the card.

1. Open the left or right slot cover with your thumb or finger.
2. Pull the tray out from the nano SIM slot, and remove the nano SIM card.
3. Close the slot cover. Press from the top to the bottom of the slot cover to lock it in place.

Storage card

Use a storage card to store your photos, videos, and music. When you need to free up phone storage space, you can also move certain apps to the storage card, if the apps support this feature.



The storage card is optional and sold separately.

Inserting the storage card

1. Open the slot cover with your thumb or finger.
2. With HTC One X9 facing down, insert a microSD into the storage card slot, with its gold contacts facing up and towards the slot.

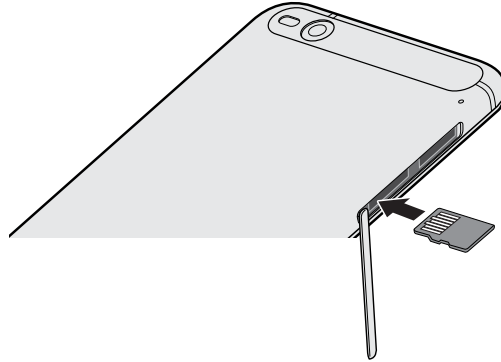



3. To close the slot cover, slide the plastic hinge into the side and press the cover until it clicks into place.

Unmounting the storage card

When you need to remove the storage card while HTC One X9 is on, unmount the storage card first to prevent corrupting or damaging the files in the storage card.



If your storage card is used as internal storage and there are apps that were moved to the card, you will not be able to open these apps after unmounting the card.

1. From the Home screen, tap  > **Settings** > **Storage & USB**.
2. Do one of the following:
 - If your storage card appears under Removable storage, tap  > **Eject** next to the card name.
 - If your storage card appears under Internal storage, tap the card name, and then tap  > **Eject**.

Removing the storage card

1. Open the slot cover with your thumb or finger.
2. Push the storage card in to eject it from its slot.
3. To close the slot cover, slide the plastic hinge into the side and press the cover until it clicks into place.

Charging the battery

Before you turn on and start using HTC One X9, it is recommended that you charge the battery.



- If the battery has been discharged for several days, you may need to charge HTC One X9 for several minutes before powering it on.
- Use only the adapter and the USB cable that came with HTC One X9 to charge the battery. When the battery power is too low, make sure to use the power adapter to charge, not the USB cable connection with your computer.

1. Insert the small end of the USB cable into the USB connector.

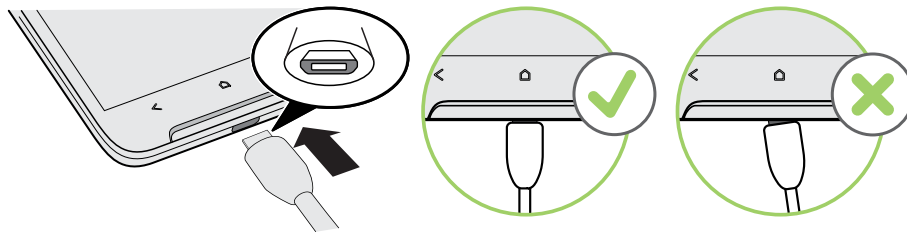

2. Insert the other end of the USB cable into the power adapter.
3. Plug in the power adapter to an electrical outlet to start charging the battery.



- As a safety precaution, the battery may stop charging to avoid overheating.
- Avoid charging the battery in hot environments.
- When you're using the web browser and charging the battery, HTC One X9 may become warmer. This is normal.
- To conserve energy, unplug the power adapter from the electrical outlet after you finish charging.

Switching the power on or off

Switching the power on

Press the POWER button until HTC One X9 vibrates.



When you turn on HTC One X9 for the first time, you'll need to set it up.

Switching the power off

1. If the display is off, press the POWER button to turn it back on.
2. Press and hold the POWER button for a few seconds.
3. Tap **Power off** on the options menu.

Want some quick guidance on your phone?

Check out the friendly walkthroughs and the FAQs in the Help app to learn how to use your phone.

- When you see a Tips & Help tile in HTC BlinkFeed™, just tap the tile to know more about the tip.
- From the Home screen, tap , and then find and tap **Help**.

You can then tap **Search help articles & videos**, and enter what you're looking for. Or you can tap  to browse how-tos, FAQs, and more.

Phone setup and transfer

Setting up HTC One X9 for the first time

When you switch on HTC One X9 for the first time—or after you’ve done a factory reset—you’ll be asked to set it up.



You can enable TalkBack to navigate by voice feedback before selecting the language. Press and hold two fingers on the screen until you hear a message saying that accessibility mode is enabled.

Walk through the on-device setup to choose your Internet connection, sign in to your Google Account, set up device protection for HTC One X9, and more.

Use Android Backup Service if you’ve used it to back up your old phone before. On the Get your app & data screen, tap **Restore from this backup**. From the menu, choose your old phone if you want to restore your apps from a previous phone that was backed up using Android Backup Service. Otherwise, tap **Set up as new device**.



Some features that need to connect to the Internet such as location-based services and auto-sync of your online accounts may incur extra data fees. To avoid incurring data fees, disable these features under Settings. For more information on location services, see [Turning location services on or off](#) on page 158.

Restoring from your previous HTC phone

If you were using HTC Backup on your previous HTC phone, you need to download and use the HTC Restore app on HTC One X9 to restore your backup.



Depending on the amount of content, restoring a backup to HTC One X9 through your data connection may incur additional data costs and take a long time. Using a Wi-Fi connection is recommended.

1. After you’ve finished setting up HTC One X9, slide the Notifications panel open, and then tap the **Transfer or restore your content** notification.
2. Tap **Restore from HTC backup**.
If the HTC Restore app is not installed on the phone, you’ll be prompted to download and install HTC Restore.
3. Tap **Restore from HTC backup**.
4. Sign in with the account you used to back up your old phone.
5. Choose the backup to restore to HTC One X9.

6. If prompted, choose whether to use a mobile data or Wi-Fi connection for restoring your backup.
7. Follow the onscreen instructions to restore your backup.
8. Slide open the Notifications panel to check if there's any notification to finish restoring your backup.

Free apps from Google Play will be restored in the background, and you can track the progress via a notification in the status bar. To restore paid apps, you need to download and install them from Google Play.

Your apps will appear on the Apps screen as they are installed. The Apps and Home screen shortcuts will be reorganized as in your backup after all of your apps have been installed. You can continue using HTC One X9 while apps are being restored.

Transferring content from an Android phone

On your old Android phone, download the HTC Transfer Tool and use it to transfer your content to HTC One X9.

The types of locally stored content on your old phone that the HTC Transfer Tool can transfer include contacts, messages, calendar events, music, photos, videos, and some settings. More types of data such as call histories, email accounts, and some HTC app settings can be transferred from HTC phones that have HTC Sense 5.5 or higher.



You need Android version 2.2 or later to use the HTC Transfer Tool on your old phone.

1. From the Home screen, tap  > **Settings** > **Get content from another phone**.
2. Choose whether to transfer from an HTC Android phone or other Android phone.
3. On the Get content from another phone screen, tap **Next**.
4. Follow the steps shown on HTC One X9 to download the HTC Transfer Tool from Google Play to your old phone, install it, and open the tool.
5. When you see a PIN on your old phone, make sure the same PIN also appears on HTC One X9 before you continue.

If the PIN code doesn't appear, tap **Retry** on your old phone. If it still won't appear, this may mean that your old phone is unable to connect to HTC One X9. When this happens, try another transfer method.

6. Tap **Confirm** on your old phone.
7. On your old phone, choose the types of content you want to transfer, tap **Transfer**, and then tap **Yes**.
8. Wait for the transfer to finish.
9. Tap **Done** on both phones.

Ways of transferring content from an iPhone

If you have an iPhone, there are easy ways to transfer your contacts, messages, and other content to HTC One X9.

- Back up and restore iPhone content through iCloud. To find out how, see [Transferring iPhone content through iCloud](#) on page 21.
- Back up iPhone content using iTunes on your computer, and then use HTC Sync Manager to transfer the content to HTC One X9. For details, see [Transferring iPhone content and apps to your HTC phone](#) on page 114.

Transferring iPhone content through iCloud

If you have an iCloud account, sync iPhone content to your iCloud storage, and then transfer the content to HTC One X9. You can transfer the following types of content from iCloud: contacts, bookmarks, text messages, messages from iMessage, calendar events, and photos.

1. From the Home screen, tap  > **Settings** > **Get content from another phone**.
2. Tap **iPhone** > **Import from iCloud backup**.
3. Follow the steps shown onscreen to back up your iPhone content to your iCloud storage.
4. Enter your iCloud email address and password, and then tap **Sign in**.
5. Choose the iPhone backup that you want to transfer to HTC One X9, and then tap **Next**.
6. Choose the types of content you want to transfer, and then tap **Import**.
7. Wait for the transfer to finish, and then tap **Done**.



Only some contact details can be transferred, such as the contact name, photo, postal address, email address, birthdate, anniversary date, and notes.

Other ways of getting contacts and other content

There are different ways you can individually add contacts and other content to HTC One X9.

Sync with your computer	Use HTC Sync Manager to sync contacts, documents, playlists, and more between HTC One X9 and your computer running a Windows® or OS X operating system. You can also use it to transfer your iTunes backup that contains contacts, messages, and other content from an iPhone from your computer to HTC One X9.
Google Account	Google contacts are imported to HTC One X9 after you sign in to your Google Account. You can also create more Google contacts right from HTC One X9.
Social network accounts	Log in to your favorite social networks to sync contact information from them.

Microsoft® Exchange ActiveSync®	HTC One X9 syncs your work contacts from the Microsoft Exchange ActiveSync Server in your workplace.
Outlook.com account	Sync personal contacts from your Microsoft Outlook.com account.
Phone contacts	You can create contacts locally on HTC One X9, if you don't prefer to store them on your online accounts.
nano SIM cards	Copy all your nano SIM contacts to HTC One X9.

Transferring photos, videos, and music between your phone and computer

Here are ways you can transfer your media from or to your computer.

- Connect HTC One X9 to your computer. Your computer will recognize it just like any removable USB drive, and you can copy your media between them. See [Copying files between HTC One X9 and your computer](#) on page 105.
- Download and use the HTC Sync Manager software on your computer. You can set it up to automatically get music, photos, and videos off HTC One X9 to your computer. You can also sync playlists from your computer to the phone.

If you have an iPhone, you can also connect it and transfer camera roll photos to your computer using HTC Sync Manager. Then reconnect HTC One X9 and copy them over.

See [About HTC Sync Manager](#) on page 113.

- Use cloud storage services to put your media in one place so you can manage them anywhere —on your computer, HTC One X9, and other mobile devices.

Using Quick Settings

In the Quick Settings panel, easily turn settings such as Wi-Fi and Bluetooth on or off.

Do any of the following:



- With two fingers, swipe down from the status bar.



- Swipe down twice from the status bar.

Getting to know your settings

Want to change the ringtone, set up a Wi-Fi connection, or add your accounts? Do this and more in Settings.

1. Open Settings from the Apps screen, Notifications panel, or Quick Settings panel.
 - From the Home screen, tap  to switch to the Apps screen, and then tap **Settings**.
 - Swipe down from the top of the screen to open the Notifications panel, and then tap .
 - With two fingers, swipe down from the top of the screen to open Quick Settings, and then tap .
2. Here are some of the basic settings you can change:
 - Tap the **On/Off** switch next to an item such as Wi-Fi to turn it on or off. Tap the item itself to configure its settings.
 - Tap **Sound & notification** to set a ringtone, choose a sound profile, and configure notification settings.
 - Tap **Personalize** to change the wallpaper, add apps and widgets to the Home screen, and more.
 - Tap **Accounts & sync** to add and sign in to your different accounts, such as email, social networks, and more.
 - Tap **Security** to help secure HTC One X9, for example with a screen lock.



Tap  in Settings to quickly find options and settings.

Updating your phone's software

HTC One X9 can check and notify you if there's a new update available.

Updates for some HTC apps and features, such as HTC Sense Home, may be downloaded and installed from Google Play. See [Installing app updates from Google Play](#) on page 24 for details.

Checking your system software version

Before installing a system software update, you can check first what Android and HTC Sense versions you have on your phone.

1. From the Home screen, tap  > **Settings** > **About**.
2. Tap **Software information**.

Enabling automatic updates

You can choose to automatically download and install software updates for HTC or mobile operator apps.

1. From the Home screen, tap , and then find and tap **Settings**.
2. Tap **About** > **Software updates**.
3. To save on data usage, you can choose to update through Wi-Fi only.
4. Choose whether to auto-download system updates, app updates, or both.

App updates are installed automatically. You'll still need to confirm when to install system software updates.

Installing a software update

When HTC One X9 is connected to the Internet and there's a new software update available, the update notification icon  appears in the status bar.

1. Slide the Notifications panel open, and then tap the system update notification.
2. If you don't want to download the update using your data connection, select **Update over Wi-Fi only**.
3. Tap **Download**.
4. When download is complete, select **Install now**, and then tap **OK**.

After updating, HTC One X9 will restart.



Installing an application update

When Internet connection is on and there's an available update for your HTC or mobile operator apps, the update notification icon  appears in the status bar.

1. Slide the Notifications panel open, and then tap the update notification.
The Updates screen opens with the list of application updates to be installed.
2. Tap an item to view its details, and then tap **<**.
3. When you're done reviewing the updates, tap **Install**. You'll be asked to restart HTC One X9 if needed.

Installing app updates from Google Play

Some HTC apps and third-party apps get updated with improvements and bug fixes through Google Play. You can manually update apps or set your phone to automatically download and install app updates when available.

1. From the Home screen, tap , and then find and tap **Play Store**.
2. Tap  to open the slideout menu.

3. Tap **My apps**.

You'll see a list of apps installed on your phone.

4. Under Updates, tap an app.
5. Tap **Update**.
6. Tap **Accept**.



In Play Store, tap  > **Settings** > **Auto-update apps** to choose how you want Google Play to update your apps.

Checking for updates manually

1. From the Home screen, tap  > **Settings** > **About**.
2. Tap **Software updates**. HTC One X9 checks if updates are available.



If you don't have Internet connection, you'll be prompted to turn on mobile data or connect to a Wi-Fi network. Once connected, tap **Check now** to check for updates.

Getting apps from Google Play

Google Play is the place to go to find new apps for HTC One X9. Choose from a wide variety of free and paid apps ranging from productivity apps, entertainment, to games.



- You need a Google Wallet™ account to buy paid apps or to make in-app purchases. If you already have a Google Account, just add Google Wallet by signing in with your existing username and password at wallet.google.com.
- The name of the Play Store app may differ depending on your region.
- The ability to purchase apps varies by region.

Finding and installing an app

When you install apps and use them on HTC One X9, they may require access to your personal information or access to certain functions or settings. Download and install only apps that you trust.



Be cautious when downloading apps that have access to functions or a significant amount of your data on HTC One X9. You're responsible for the results of using downloaded apps.

1. From the Home screen, tap , and then find and tap **Play Store**.
2. Browse or search for an app.
3. When you find the app that you like, tap it and read its description and user reviews.

4. To download or purchase the app, tap **Install** (for free apps) or the price button (for paid apps).
5. Tap **Accept**.





Apps sometimes get updated with improvements or bug fixes. To automatically download updates, after installing the app, tap  > **Auto-update**.

To open the app, go to the Apps screen and tap the app.

Restoring apps from Google Play

Upgraded to a new phone, replaced a lost one, or performed a factory reset? Restore apps that you previously downloaded.

1. From the Home screen, tap , and then find and tap **Play Store**.
2. Tap  to open the slideout menu.
3. Tap **My apps**, swipe to the All tab, and then tap the app you want to restore.
4. Install the app.

For more details, refer to the Google Play help.

Downloading apps from the web

You can download apps directly from websites.



- Apps downloaded from websites can be from unknown sources. To help protect HTC One X9 and your personal data, we strongly recommend that you only download from websites you trust.
- Before you can install the downloaded app, make sure that you've set HTC One X9 to allow installation of third-party apps in **Settings > Security > Unknown sources**.

1. Open the browser, and then go to the website where you can download the app you want.
2. Follow the website's download instructions for the app.



After installing the app, make sure to go back to **Settings > Security** and clear the **Unknown sources** option.

Uninstalling an app

If you no longer need an app that you've downloaded and installed, you can uninstall it.



Most of the preloaded apps cannot be uninstalled.

From the Apps screen, press and hold the app you want to remove, and then drag it to **Uninstall**.



If you purchased an app in Play Store, you can uninstall it for a refund within a limited time. To know more about the refund policy for paid apps, refer to the Google Play help.

Your first week with your new phone

Basics

HTC Sense Home

After you've turned on and set up HTC One X9 for the first time, you'll see the Home screen.

- Set up the HTC Sense Home widget to experience the convenience of a Home screen that automatically adjusts when you're at home, work, or outdoors. See [What is the HTC Sense Home widget?](#) on page 35.
- Swipe right and you'll find HTC BlinkFeed. You can customize HTC BlinkFeed to show posts from your social networks, headlines from your favorite news media, and more. For details, see [What is HTC BlinkFeed?](#) on page 59.
- Swipe left and you'll discover space for adding your favorite widgets, apps, and more so they're just a tap away. You can also add panels. For details, see [Adding or removing a widget panel](#) on page 55.
- You can change the apps on the launch bar at the bottom of the Home screen. See [Launch bar](#) on page 53.



While you're in another screen or app, press  to return to the last Home screen you visited.

Sleep mode

Sleep mode saves battery power by putting HTC One X9 into a low power state while the display is off. It also stops accidental button presses when HTC One X9 is in your bag.

Switching to Sleep mode

To turn off the display and switch to Sleep mode, briefly press the POWER button. You can also double-tap the lock screen.

HTC One X9 also automatically goes into Sleep mode when it's left idle for a while. You can change the time before HTC One X9 sleeps by setting the screen timeout. For details, see [Setting when to turn off the screen](#) on page 161.

Waking up from Sleep mode

- Press the POWER button.
- Use Motion Launch™ to wake up and unlock your phone directly to an app or screen. See [What is Motion Launch?](#) on page 37.

Unlocking the screen

Swipe up to unlock the screen.

If you've set up a screen lock, you'll be asked to provide your credentials before HTC One X9 unlocks.



If you've set an event reminder or an alarm, you can snooze or dismiss the event or alarm right from the lock screen. Just drag ⌚ or ✖ up.

Motion gestures

Use motion gestures to mute HTC One X9, lower the ring volume, and more.

Lift phone to auto answer a call

To automatically answer an incoming call, lift the phone and look at the screen first to see who's calling before you hold it to your ear.

You can turn this feature on or off. In **Settings > Call**, select or clear **Auto answer calls**.

Flip to mute



If your phone is facing up when a call comes in, turn the phone over to mute it.

If you go to Settings and then tap **Sound & notification > Flip to mute**, you can set your phone to:

Mute once	Mute only once after flipping the phone. While the phone is still facing down, it will ring again when there are other incoming calls.
Mute always	After flipping the phone to mute a call, keep it always muted while it's still facing down when there are other incoming calls.

Pick up to lower volume



In a business meeting or restaurant, pick HTC One X9 up when a call comes in to lower the ring volume automatically.

You can turn this feature on or off. Go to Settings, tap **Sound & notification**, and then select or clear **Quiet ring on pickup**.

Increase ring volume automatically while phone is in your pocket or bag



Pocket mode makes HTC One X9 recognize when your phone is in your bag or pocket and raise the ring volume so that you can hear it in noisy environments.

You can turn this feature on or off. Go to Settings, tap **Sound & notification**, and then select or clear **Pocket mode**.

Rotate HTC One X9 for a better view

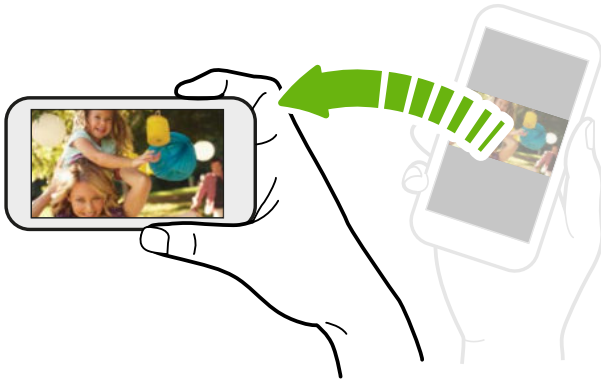

For many screens, you can automatically change the screen orientation from portrait to landscape by turning HTC One X9 sideways.

When entering text, you can turn HTC One X9 sideways to bring up a bigger keyboard.

Touch gestures

Use touch gestures to get around the Home screen, open apps, scroll through lists, and more.

Tap

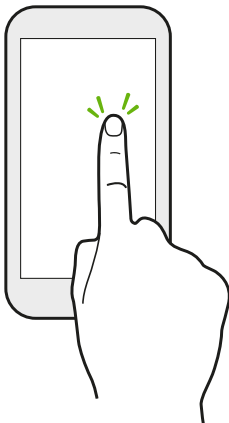

Tap the screen with your finger when you want to select onscreen items such as application and settings icons, or press onscreen buttons.

Press and hold



To open the available options for an item (for example, a contact or link in a webpage), just press and hold the item.

Swipe or slide

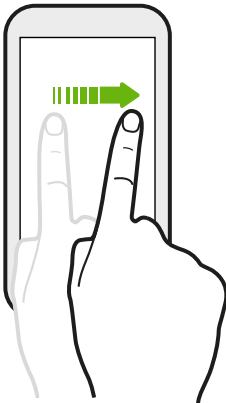

Quickly swipe your finger horizontally across the screen to go to other Home screen panels. Swipe vertically to scroll through a list, document, and more.

Drag

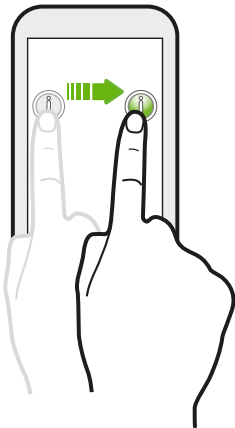

Press and hold your finger with some pressure before you start to drag. While dragging, don't release your finger until you have reached the target position.

Flick

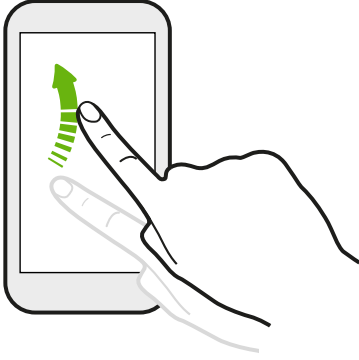

Flicking the screen is similar to swiping, except that you need to swipe your finger in light, quicker strokes, such as when moving right and left on the Home screen, or flicking through a contacts or message list.

Press and flick

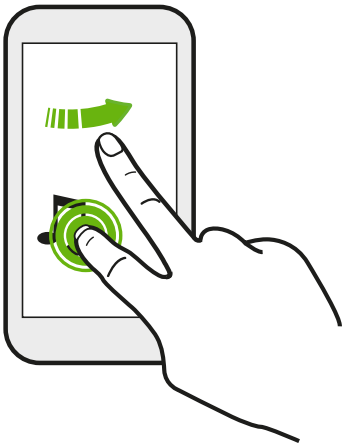

On the Home screen, you can easily move a widget or icon from one screen to another.

Press and hold the widget or icon with one finger, and flick the screen to the new location with another finger.

Slide with two fingers

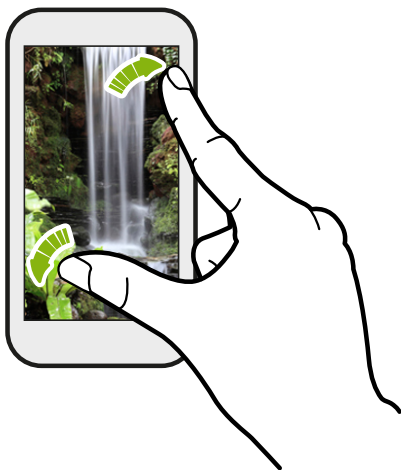

In some apps, like Gallery, Messages, Mail, or the web browser, slide two fingers apart to zoom in when viewing a picture or text.

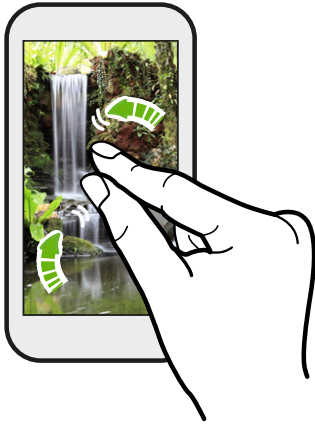

Slide two fingers together to zoom out of the picture or text.

Two-finger swipe

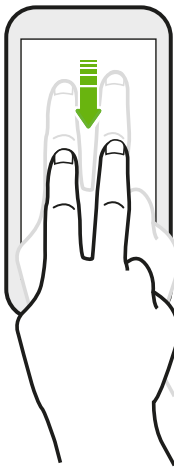

Swipe down from the status bar using two fingers to access Quick Settings.

Three-finger swipe

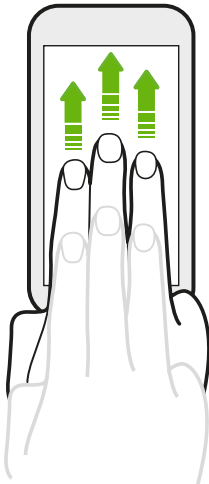



- Swipe up the screen with three fingers and HTC Connect™ streams music or video from HTC One X9 to your speakers or TV respectively. You can also share streaming media from apps such as YouTube®.
- Swipe down to disconnect from your speakers or TV.



Media gesture is turned on in Settings by default, which makes the three-finger gesture work for sharing media.

Opening an app

- Tap an app on the launch bar at the bottom of the Home screen.
- Tap  to go to the Apps screen, and then tap the app you want to use.
- On the Apps screen, tap , and then enter the name of the app you're looking for.

Opening an app or folder from the lock screen

On the lock screen, drag an app or folder icon up to unlock the screen and directly go to the app or folder.





The shortcuts on the lock screen are the same ones on your Home screen's launch bar. To change the lock screen shortcuts, replace the apps or folders on the launch bar.

If you've set up another security layer like a screen lock pattern or PIN, you'll be asked to provide your credentials first before HTC One X9 opens the app or folder.

Sharing content

Have something to share, such as a photo or video?

- In an app, just tap the share icon:  or .
- If you don't see the icon, tap  > **Share**.

Switching between recently opened apps

When you're multitasking and using different apps on HTC One X9, you can easily switch between the apps you've recently opened.

Press  to see recently-opened apps.

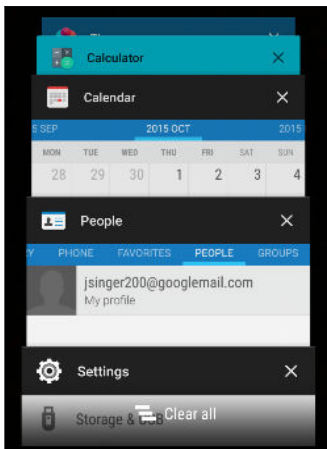

- To switch back to an app, flip through the cards to find the app and tap it.
- To remove an app from the list, drag it left or right.
- To remove all of the apps at once, tap .

Refreshing content

In some apps, you can easily refresh content that's synced or downloaded from the Web with a simple finger gesture.

1. While viewing content such as weather or Mail inbox, scroll to the top of the screen.
2. Pull down with your finger, and then release to refresh.



Capturing your phone's screen

Want to show off your high game score or write a blog post about HTC One X9 features? It's easy to take a picture of the screen and share it from Gallery.

Press and hold POWER and VOLUME DOWN at the same time.

The image is saved in the Screenshots album in Gallery.



You can also share the image when you see  in the status bar. Open the Notifications panel and tap  under the screenshot notification. If you don't see , slide two fingers apart on the screenshot notification.

HTC Sense Home widget

What is the HTC Sense Home widget?

Get quick access to apps, shortcuts and folders you use most frequently based on where you are. With the HTC Sense Home widget, HTC One X9 continually adapts to how you use it. For example, apps you use most frequently for work, will show up when you're at your office. The HTC Sense Home widget changes depending on whether you're at home, work, or somewhere else.

Setting up the HTC Sense Home widget

Setting up the HTC Sense Home widget is quick and easy.



- If you don't see the HTC Sense Home widget, add it to your Home screen. See [Adding Home screen widgets](#) on page 54.
- Make sure you turn on location services in your phone settings. See [Turning location services on or off](#) on page 158.

1. On the setup screen of the HTC Sense Home widget, tap **Tap to personalize > Let's explore**.

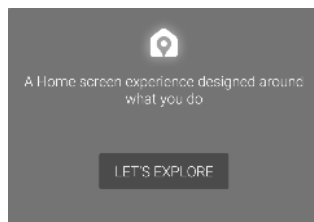

2. Tap where you are to finish setting up the widget.

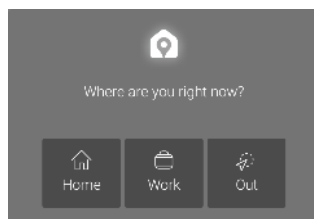

3. On the widget, tap \sphericalangle > \vdots > **Personalize HTC Sense Home**.
4. Select all the options on the screen, and then press \sphericalangle .

Setting your home and work locations

In the HTC Sense Home widget, set your home and work locations based on your address, Wi-Fi network, or both.

You can associate multiple addresses and Wi-Fi networks to each of these locations. Using your set addresses or Wi-Fi networks, the HTC Sense Home widget will be able to determine where you are and display the appropriate apps.

1. On the Home screen, swipe right or left until you see the HTC Sense Home widget.
2. Tap \sphericalangle > \vdots > **Set locations**.
3. Choose the location you want to set.
4. Tap \oplus and do one of the following:
 - Tap **Address** and then enter your street address or select it on the map.
 - Tap **Wi-Fi network** and select one or more Wi-Fi networks you want to associate with the location.
5. When you've finished setting your home and work locations, press \sphericalangle .

Manually switching locations

The HTC Sense Home widget automatically changes locations based on where you are. You can also manually change the location in the HTC Sense Home widget.

For the HTC Sense Home widget to change locations automatically, you need to make sure that location services is turned on. See [Turning location services on or off](#) on page 158.

1. On your Home screen, slide right or left until you see the HTC Sense Home widget.
2. Tap \sphericalangle , and then tap the location you want.

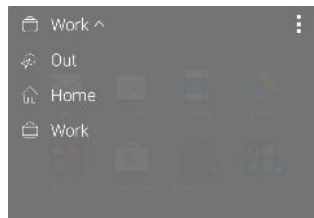

Pinning and unpinning apps

Pinning apps, shortcuts, or folders to the HTC Sense Home widget ensures they stay on the widget.

Items in the HTC Sense Home widget will have one of two states: pinned or unpinned. Unpinned items will be automatically changed to more frequently used items.

1. On the Home screen, swipe right or left until you see the HTC Sense Home widget.
2. Do one of the following:
 - To pin an item, press and hold it until you see .
 - To unpin an item, press and hold it until the unpinning progress bar has completed.

Adding apps to the HTC Sense Home widget



Add your favorite apps, shortcuts, or folders to the HTC Sense Home widget.

1. From the Home screen, tap .
2. Press and hold the app, shortcut, or folder you want to add to the widget.
3. Drag the item to where you want in the HTC Sense Home widget.

The app, shortcut or folder will be added to the HTC Sense Home widget and pinned in place.

Turning smart folders on and off

Smart folders are folders in the HTC Sense Home widget that dynamically change contents depending on the apps you download and use. If you don't want to see recently downloaded or recommended apps, you can turn off the smart folders.

1. On the Home screen, swipe right or left until you see the HTC Sense Home widget.
2. Tap , and then tap  > **Show/hide smart folders**.
3. Select the smart folders you want to show or hide.
4. Tap **OK**.

Motion Launch

What is Motion Launch?

Motion Launch is a combination of a motion gesture followed by a finger gesture. With Motion Launch, you don't have to reach for the POWER button to wake up HTC One X9. Using a combination of simple gestures, you can wake up to your Home screen, HTC BlinkFeed, and more.

See the following:

- [Waking up to the lock screen](#) on page 38
- [Waking up and unlocking](#) on page 38
- [Waking up to the Home widget panel](#) on page 39

- [Waking up to HTC BlinkFeed](#) on page 39
- [Auto launching the camera with Motion Launch Snap](#) on page 40

Turning Motion Launch gestures on or off

Choose the Motion Launch gestures you want on or off in Settings.

1. From the Home screen, tap  > **Settings** > **Display & gestures** or **Display, gestures & buttons**.
2. Tap **Motion Launch gestures**.
3. Select the Motion Launch gestures you want.

Waking up to the lock screen

Go from sleep mode to the lock screen without pressing the POWER button.



If you've set up a screen lock with credentials, you'll be asked to provide your credentials first before HTC One X9 unlocks.

1. Lift the phone in portrait orientation.
2. Immediately double-tap the screen.

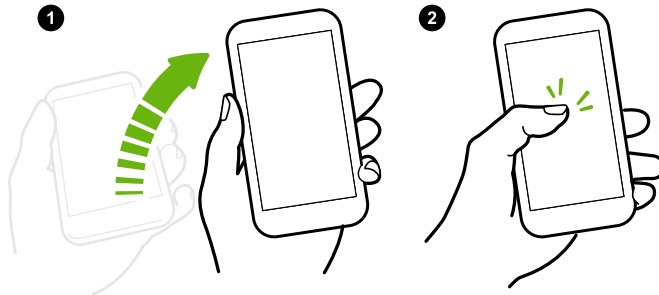

Waking up and unlocking

Go from sleep mode and unlock HTC One X9 to the last screen you were using without pressing the POWER button.



If you've set up a screen lock with credentials, you'll be asked to provide your credentials first before HTC One X9 unlocks.

1. Lift the phone in portrait orientation.
2. Immediately swipe up from the bottom half of the screen.

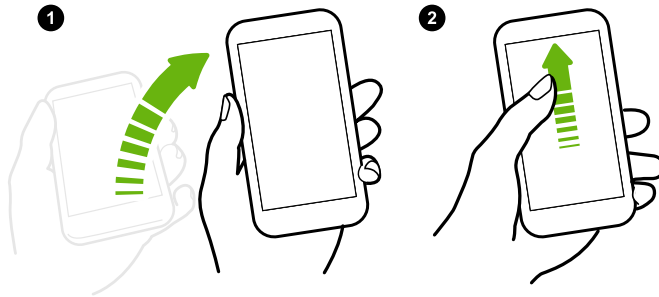

Waking up to the Home widget panel

Go from sleep mode to the Home widget panel without pressing the POWER button.



If you've set up a screen lock with credentials, you'll be asked to provide your credentials first before HTC One X9 unlocks.

1. Lift the phone in portrait orientation.
2. Immediately swipe left from the right side of the screen.

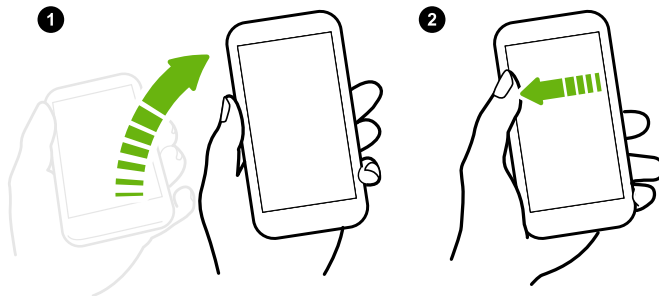

Waking up to HTC BlinkFeed

Go from sleep mode to HTC BlinkFeed without pressing the POWER button.



If you've set up a screen lock with credentials, you'll be asked to provide your credentials first before HTC One X9 unlocks.

1. Lift the phone in portrait orientation.
2. Immediately swipe right from the left side of the screen.

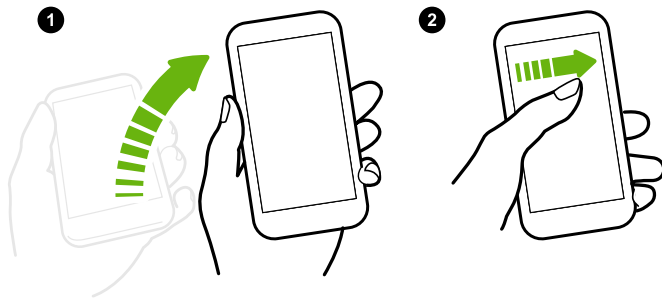

Auto launching the camera with Motion Launch Snap

When the screen is off, you can wake up the phone directly to the Camera app.

- Press and hold the VOLUME UP or VOLUME DOWN button, and then lift the phone in landscape orientation.
- Or first lift the phone in landscape orientation, and then press the VOLUME UP or VOLUME DOWN button right away.

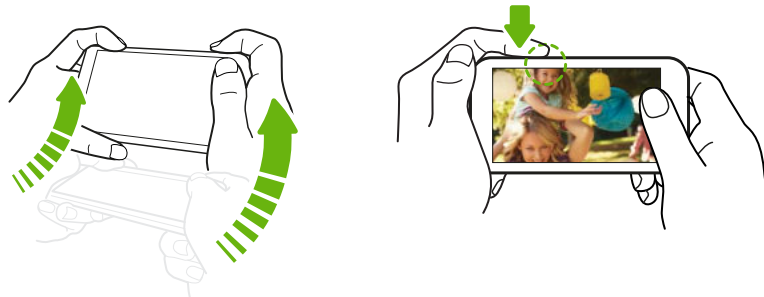

If you've set up a screen lock with credentials, you'll be asked to provide your credentials when you exit the Camera app.

Lock screen

Setting a screen lock

Help protect your personal information and help prevent others from using HTC One X9 without your permission.

Choose to set a screen lock pattern, numeric PIN, or other means of locking your phone. You'll be asked to unlock the screen every time HTC One X9 is turned on or when it's idle for a certain period of time.

1. From the Home screen, tap  > **Settings** > **Security**.
2. Tap **Screen lock**.

3. Select a screen lock option and set up the screen lock.
4. Tap **Lock phone after**, then specify the idle time before the screen is locked.



You can also clear **Make pattern visible** or **Make passwords visible** if you don't want your screen lock to display as you enter it onscreen.

Setting up Smart Lock

Set up your phone to detect your face or another trusted device before you can unlock the screen.

1. From the Home screen, tap  > **Settings** > **Security**.
2. Tap **Screen lock**, and then select and set up a screen lock.
This will be your backup screen lock method.
3. On the Security screen, tap **Smart Lock**.
4. Confirm your screen lock.
5. Choose what you want your phone to detect before it unlocks.
6. Follow the onscreen instructions.
7. Tap **Lock phone after**, and then specify the idle time before the screen is locked.

To help make Smart Lock more reliable and more secure, you can train HTC One X9 to recognize your face in different situations, such as when you're wearing glasses or sporting a beard.

Tap **Smart Lock**, confirm your screen lock, then tap **Trusted face** > **Improve face matching**. Follow the onscreen instructions.

Turning lock screen notifications on or off

You can choose to turn lock screen notifications on or off.

1. From the Home screen, tap  > **Settings** > **Sound & notification**.
2. Tap **When device is locked** > **Don't show notifications at all**.



If you change your mind later, you can tap **Show all notification content** to turn lock screen notifications on.

Interacting with lock screen notifications

Besides seeing notifications on the lock screen, you can also interact with them.



1. Tap twice on a notification to go directly to the related app.
2. To see the entire list of notifications on the lock screen, swipe down on the lock screen. You can tap on a blank area of the screen to return to the lock screen.
3. Swipe left or right on the notification to remove it.
4. Press and hold a notification to see more related information.
5. Tap  to prioritize notifications from the related app.

Changing lock screen shortcuts

To change apps (or other shortcuts) on the lock screen, change the ones on the launch bar. To find out how, see [Launch bar](#) on page 53.

Changing the lock screen wallpaper

Use any photo you've taken with the camera as the lock screen wallpaper.

1. From the Home screen, tap  > **Settings** > **Personalize**.
2. Under Themes, tap **Change or edit theme**.
3. Tap  > **Next** > **Edit** > **Other wallpapers**.
4. Slide to the Lock screen thumbnail, tap **Change wallpaper**, and then choose a source for your wallpaper.
5. Tap  > **Preview** > **Finish**.
6. Enter a title for the theme, ensure the **Apply this theme now** option is selected. Then tap **OK**.

Turning the lock screen off

Rather not have to unlock your phone every time you wake it up? You can turn the lock screen off in Settings.

1. From the Home screen, tap  > **Settings** > **Security**.
2. Tap **Screen lock** > **No lock screen**.

To turn the lock screen on again, in Security settings, tap **Screen lock** > **Lock screen**.

Notifications

Notifications panel

Notification icons inform you of new messages, calendar events, alarms, and activities in progress such as files downloading.



When you see notification icons, open the Notifications panel to check out details of the notifications that you've received.

To open the Notifications panel, slide down from the top of the screen.

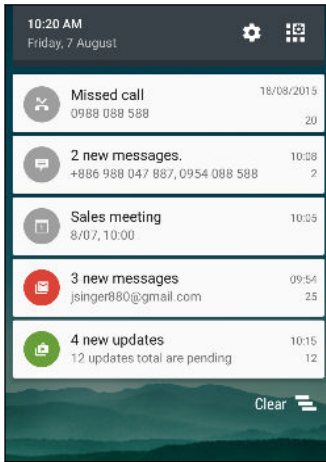

- Some notifications allow you to take immediate action. For example, tap a missed call notification to return the call or reply with a text message.
- Tap the notification icon on the left to open the corresponding app.
- To dismiss just one notification in the list, drag it left or right. To dismiss all non-persistent notifications, tap .



If you have several notifications, scroll through the list screen to see them all.



You can change what app notifications you want to receive. See [Managing app notifications](#) on page 43.

Managing app notifications

You can set the priority, sensitivity, and more.

1. From the Home screen, tap  > **Settings** > **Sound & notification**.
2. Tap **App notifications**, and then tap the app you want manage.
You can also press and hold a notification in the notifications panel, and then tap .
3. Tap the **On/Off** switch next to option you want to toggle.

Settings for app notifications are applied to notifications in the Notifications panel and the lock screen.

Notification LED

The notification LED shows a:

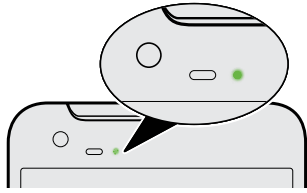

- Solid green light when HTC One X9 is connected to the power adapter or a computer and the battery is fully charged.
- Flashing green light when you have a pending notification.
- Solid orange light when the battery is being charged.
- Flashing orange light when the battery level reaches very low.

Choosing when to flash the notification LED

You can change when to flash and which apps will flash the LED when there are new notifications.

1. From the Home screen, tap **⋮** > **Settings** > **Sound & notification**.
2. Under Notification, tap **Flash notifications**. Choose whether to always flash the LED or flash it only when the screen is off.
3. Tap **App light notifications**. Choose which app notifications you want the LED to flash for.



In other apps, check their settings to find out if they have an option for flashing the LED.

Working with text

Selecting, copying, and pasting text

In HTC apps such as Mail and Messages, you can select and copy text, and then paste or share it.

1. Press and hold on a word.
2. Drag the start and end anchors to highlight the surrounding text you want to select.

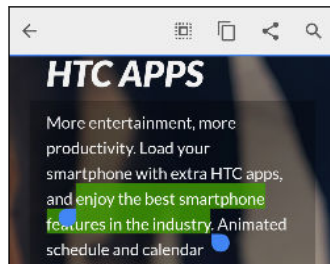



3. After you have selected the text you want to copy, tap **☐** or **Copy**.

The selected text is then copied to the clipboard.

4. In a text entry field (for example while composing an email), press and hold at the point where you want to paste the text.
5. Tap **☐** or **Paste**.

Sharing text

1. After you have selected the text you want to share, tap  or  or **Share**.
2. Choose where to paste and share the selected text, such as in an email message or social network status update.

The HTC Sense keyboard

Typing is fast and accurate with the HTC Sense keyboard.

- Word prediction also saves typing time. As you type, you'll see word suggestions that you can choose from. You can even add words to the word prediction dictionary. See [Entering text with word prediction](#) on page 46.
- You can type words by just speaking. See [Entering text by speaking](#) on page 48.
- Turn on the Trace keyboard so you can type words by just sliding your finger from one letter to another. See [Using the Trace keyboard](#) on page 47.
- Just swipe right to access the numeric and symbol keyboard. Or swipe left to switch between languages.
- The keys have secondary numbers, punctuation symbols, or other characters that you can insert without having to switch to the numeric and symbol keyboard.



For example, just press and hold a key on the first row to insert a number.

- Choose from a wide selection of emoji.
- Show or hide navigational arrow keys on the keyboard. If you enable the arrow keys in Settings, they'll only appear on the portrait keyboard.

Entering text

The onscreen keyboard becomes available when you tap a text field in an app.

Tap the keys on the onscreen keyboard to enter letters and numbers, as well as punctuation marks and symbols.

- Tap  to enter an uppercase letter. Tap twice to turn on caps lock.
- Press and hold keys with gray characters at the top to enter numbers, symbols, or accented letters. Some keys have multiple characters or accents associated with them.
- Swipe right to show number and symbol keys. To return to the main keyboard, swipe left.
- Press  to close the onscreen keyboard.



To open the keyboard settings, press and hold the comma key if you see  above the key. Or go to **Settings > Language & keyboard > HTC Sense Input**.

Choosing and switching between keyboard languages

If multiple keyboard languages are available on HTC One X9, you can choose which languages to enable in the onscreen keyboard.

1. Go to Settings, and then tap **Language & keyboard > HTC Sense Input**.
2. Tap **Keyboard selection**, and then choose the languages you want.

To change the keyboard language, do any of the following:

- Swipe left on the onscreen keyboard (not available if you're using trace keyboard).
- Tap the language key, for example, **EN**, until you see the keyboard language you want to use.
- Press and hold the language key, and then drag your finger to the keyboard language you want to use.

Entering text with word prediction

Ever started typing something you weren't sure how to spell? With word prediction, you'll see suggested words displayed just above the keyboard.



Word prediction and next word prediction are enabled by default.

To enter text in word prediction mode, do any of the following:

- Tap the space bar to insert a highlighted word in the suggestion list.
- Tap a word from the suggestion list.
- Tap the arrow next to the suggestion list to see more choices.



In some keyboard languages such as English and Spanish, if you've accidentally chosen a wrong word from the suggestion list, you can go back and change it by tapping the word and selecting another suggestion.

Setting a second language for word prediction

You can set the word prediction to be bilingual. As you type, you'll get word suggestions in the languages that you've selected.



This feature is available only for Latin-based languages.

1. Go to Settings, and then tap **Language & keyboard > HTC Sense Input**.
2. Tap **Keyboard selection > Bilingual prediction**, and then choose the language you want.

Adding words to the dictionary

For certain keyboard languages such as English and Spanish, you can add frequently-used names and acronyms to the word prediction dictionary to easily find them in the suggestion list.



This feature is available only for Latin-based languages.

1. Go to Settings, and then tap **Language & keyboard** > **HTC Sense Input**.
2. Tap **Personal dictionary** > **+**.
3. Enter a word.
4. Tap **OK**.



While you're entering text using the Standard keyboard layout, tapping a suggested word that's not in the dictionary (usually the first word shown in the suggestion list) automatically stores it.

Editing or deleting words in the dictionary

1. Go to Settings, and then tap **Language & keyboard** > **HTC Sense Input**.
2. Tap **Personal dictionary**.
 - To edit a word, tap the item in the list.
 - To delete items from the dictionary, tap **:** > **Delete**. Select the words you want to remove, and then tap **Delete**.

Using the Trace keyboard

Instead of tapping the keys on the onscreen keyboard, you can "trace" to type words.



This feature is available only for Latin-based languages.

1. Turn on the Trace keyboard in **Settings** > **Language & keyboard** > **HTC Sense Input**.
2. On the onscreen keyboard, slide your finger from one letter to the next to enter a word.
3. Lift your finger when the word is completed.
4. If you want to continue entering text, slide your finger over the letters again to enter the next word.



If the word that appears after you traced isn't the one you want, you can:

- Tap a word from the suggestion list.
- Tap the arrow next to the suggestion list to see more choices.

Entering text by speaking

No time to type? Try speaking the words to enter them.

1. Tap an area where you want to enter text.
2. On the onscreen keyboard, press and hold .
3. When you see the animated microphone button and the words "Speak now", say the words you want to enter.



To set the voice input language, tap the language bar above the microphone button. You can choose one or more languages. Available languages may vary.

4. If a word doesn't match what you've spoken and it's underlined, tap the underlined word to delete it or to see more choices.
5. Enter punctuation marks by saying the name (for example, say "comma").

HTC Help

Having hardware or connection problems?

Before calling for support, you can first use the Help app to troubleshoot or perform diagnostics on your phone. This helps you in finding the problem cause, and in determining whether you can resolve the problem or you need to call for support.

From the Home screen, tap , and then find and tap **Help**.



If HTC Help is not preinstalled on your phone, you can download it from Google Play.

Personalizing

Themes

What is the Themes app?

Themes brings a quick and easy way for you to customize HTC One X9 with wallpapers, sounds, icons, and more.

Log in with your HTC account to browse from the available themes in the Themes store, or make your own.

Downloading themes



Find and download pre-made themes that make it easy for you to personalize your HTC One X9.

1. From the Home screen, tap , and then find and tap **Themes**.
2. Tap **Get Started**.
3. Sign in with your preferred account.
4. On the Recommended screen, swipe left or right under each category to browse recommended items.
5. To see all available items for a category, swipe left and tap **See all**.
6. Tap an item to see the details screen.
7. Tap **Download**.

To apply the theme after it has finished downloading, tap **Apply**. If your theme has custom sounds, all of your ringtones and alert tones will also change.

Bookmarking themes

While browsing themes, you can bookmark them so that you can easily find them later.



1. From the Home screen, tap , and then find and tap **Themes**.
2. Browse the categories to find something you like.
3. Tap the item and then tap . You'll find the bookmark in My themes. See [Finding your themes](#) on page 51.



You can remove the bookmark by tapping .

Creating your own theme from scratch

You can create and customize your own theme and even share it for others to download.

1. From the Home screen, tap , and then find and tap **Themes**.
2. Tap  > **Choose Home image** to set the main wallpaper for your theme.
3. Select an image from Gallery or take a photo with Camera.
4. Move or enlarge the crop box to the area of the image you want to include and tap .
5. Tap **Next**.
6. Swipe up or down to the pre-defined style to select for your theme.



If you don't want to customize your theme further, tap **Next** to save your theme.

7. Tap **Edit**, then tap any of the categories you want to customize, and experiment with the settings until you're satisfied.
8. When you're ready, tap **Preview** to see what your theme will look like.
9. Tap **Finish**, then name your theme and tap **OK** to save your theme.

To apply the theme right away, make sure you select the **Apply this theme now** option.

Editing a theme

After creating a theme, you can still edit it.



1. From the Home screen, tap , and then find and tap **Themes**.
2. Tap  > **Edit current theme**.
3. Make the changes you want to the theme.
4. Tap **Save** to update the current theme.

Mixing and matching themes

After selecting a theme, you can mix and match parts from other themes such as sounds, icons, wallpapers, and more.



To mix and match themes, you need to first download theme components from the catalog.

1. From the Home screen, tap , and then find and tap **Themes**.
2. Tap  > **Edit current theme**.
3. Tap **Color** and select a color scheme.
4. Tap any of the other categories you want to change.
5. Tap an item in the category. If the category is empty, tap  and choose one of the collections to select from.
6. Tap **Download** to get the content, and then tap **Apply** to apply the change to your current theme.

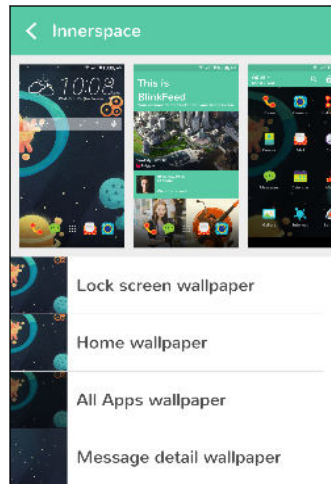

7. Tap  until you see the mix and match screen. Continue making changes until you're satisfied with the result.



8. Tap **Save copy** to save your new theme, or if you're editing a theme that you copied tap **Save** to save the changes.



Finding your themes

Themes you created or downloaded can be found in your theme collection. You'll also find the themes you bookmarked.

1. From the Home screen, tap , and then find and tap **Themes**.
2. Tap  > **My themes**.



Sharing themes

Share themes, wallpapers, icons, and more with friends and family.

1. From the Home screen, tap , and then find and tap **Themes**.
2. Browse to the theme you want to share and tap it to view the details.
3. While viewing the details page of any item in the catalog, tap  to share.

Deleting a theme

You can delete a theme if you no longer want to keep it on your phone.

1. From the Home screen, tap , and then find and tap **Themes**.
2. Tap  > **My themes**, and then swipe to the **My collections** tab.
3. Tap  > **Remove**.
4. Tap the themes you want to remove from your collection.
5. Tap **Remove**.

If the theme you deleted is currently applied, it will still be applied to HTC One X9 until another theme is applied.

More ways to personalize

Personalization settings

Aside from using Themes, you can also make HTC One X9 look and sound the way you want in Settings.

- Choose a ringtone and other sounds that you like to use. See [Ringtones, notification sounds, and alarms](#) on page 52.
- Personalize your Home screen with a different wallpaper. See [Home wallpaper](#) on page 52.
- For the lock screen, you can use the same wallpaper as your Home screen or choose a different wallpaper. See [Changing the lock screen wallpaper](#) on page 42.
- Change the fonts. See [Changing the display font](#) on page 53.
- Change the apps on the launch bar. See [Launch bar](#) on page 53.
- Populate your Home screen with widgets and shortcuts. See [Adding Home screen widgets](#) on page 54 and [Adding Home screen shortcuts](#) on page 54.
- Need another widget panel? See [Adding or removing a widget panel](#) on page 55.
- Set HTC BlinkFeed or a widget panel as your main Home screen. See [Changing your main Home screen](#) on page 56.
- Organize your apps. See [Arranging apps](#) on page 57.

Ringtones, notification sounds, and alarms

1. From the Home screen, tap  > **Settings** > **Personalize**.
2. Under Sound, choose different sounds for your ringtone, system notification, and alarm.
Go to the Messages, Mail, and Calendar apps to choose sounds for new messages, email, and event reminders respectively.



Want alarms to ring louder but notifications to be more discreet? In Settings, tap **Sound & notification** > **Volumes** and set the volume levels for each sound type.

Home wallpaper

Choose from the available wallpapers, or use any photo you've taken with the camera.

1. Press and hold an empty space on a widget panel.
2. In the pop-up menu, tap **Change Home screen wallpaper**.
3. Choose from where you want to select a wallpaper.

To use a photo you captured with the camera, tap **Gallery**, choose and crop a photo, and then tap .

Changing the display font

You can change the font style and size of the display font or you can download new fonts online.

1. From the Home screen, tap **⋮** > **Settings** > **Personalize**.
2. Under Font, tap **Font style** and choose one of the built-in fonts or tap **+** to go online and download new fonts.
3. Tap **Font size** to choose the size of the font.

Downloading fonts

You must be logged on to your HTC Account to download fonts.

1. From the Home screen, tap **⋮** > **Settings** > **Personalize**.
2. Under Font, tap **Font style** and then tap **+**.
3. Tap **▼** to select a category.
4. Select a font, and then tap **Download**.

To apply the font, tap **Apply**.

Launch bar

The launch bar gives you one-touch access to commonly used apps (and other shortcuts). You can replace the apps on the launch bar with the ones you often use.

1. Press and hold the app you want to replace, and then drag it out to **🗑**.



2. Tap **⋮** to go to the Apps screen.
3. Press and hold an app, and then drag it to the empty slot on the launch bar.



- You can also group apps on the launch bar into a folder. See [Grouping apps on the widget panel and launch bar](#) on page 57.
- The apps (or other shortcuts) on the lock screen are the same as the ones on the launch bar.

Adding Home screen widgets

Widgets make at-a-glance important information and media content easily available. Choose from a selection of widgets and add the most useful ones to your Home screen.

1. Press and hold an empty space on a widget panel.
2. In the pop-menu, tap **Add apps and widgets**.
3. Tap ▼ > **Widgets**.
4. Scroll through the widgets, or tap 🔍 to search for a specific widget.
Some widgets are available in different styles and sizes.
5. Press and hold and then drag the widget to a widget panel you want to add it to.

You can also add widgets that allow you to quickly switch on or off certain settings such as Wi-Fi and Bluetooth.

Changing the settings of a widget

You can modify basic settings of some widgets (for example, the People widget).

1. Press and hold a widget on your Home screen, and then drag it to ⚙️.
2. Customize the widget settings.

Resizing a widget

Some widgets can be resized after you've added them to your Home screen.

1. Press and hold a widget on the Home screen, and then release your finger. If a border appears, that means the widget is resizable.
2. Drag the sides of the border to enlarge or shrink the widget size.

Adding Home screen shortcuts

Place apps you often use on any widget panel of your Home screen. You can also add shortcuts to frequently used settings, bookmarked webpages, and more.

1. Press and hold an empty space on a widget panel.
2. In the pop-up menu, tap **Add apps and widgets**.
3. Tap ▼ > **Apps** or **Shortcuts**.
4. Scroll through the apps or shortcuts, or tap 🔍 to search for one.
5. Press and hold and then drag an app or a shortcut to a widget panel you want to add it to.



To add an app from the Apps screen, press and hold the app, and then drag it to a widget panel.

Editing Home screen panels

Adding or removing a widget panel



- You won't be able to add a new widget panel if you've already reached the maximum limit.
- HTC BlinkFeed always appears as the first panel (if it's not removed). A widget panel cannot be added before HTC BlinkFeed.

1. Press and hold an empty space on a widget panel.
2. In the pop-up menu, tap **Manage Home screen pages**.
3. To add a new widget panel, swipe left until you see the **+** icon, and then tap it.
4. To remove a widget panel, swipe left or right until you see the panel, and then tap **Remove**.
5. When done, press **<**.

Arranging widget panels



A widget panel cannot be moved and inserted before HTC BlinkFeed.

1. On HTC BlinkFeed or any widget panel, slide two fingers together to customize the Home screen.
2. Press and hold a widget panel thumbnail, and then drag it left or right to the position that you want.
3. When you're done arranging widget panels, press **<**.

Moving a widget or icon

You can easily move a widget or icon from one widget panel to another.

1. Press and hold the widget or icon with one finger.
2. With another finger, flick left or right to rotate the screen to another widget panel.

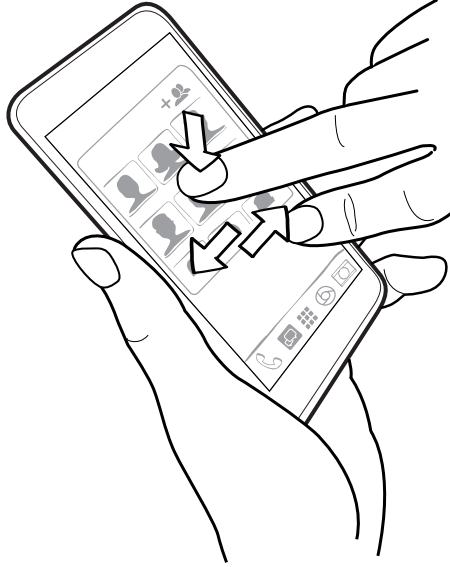

3. Release the widget or icon.

Removing a widget or icon



1. Press and hold the widget or icon you want to remove, and then drag it to .
2. When the widget or icon turns red, lift your finger.

Changing your main Home screen

Set HTC BlinkFeed or a widget panel as your main Home screen.

1. Press and hold an empty space on a widget panel.
2. In the pop-up menu, tap **Manage Home screen pages**.
3. Swipe left or right until you see the panel that you want to use as your main Home screen.
4. Tap **Set as home**.
5. Press .



Pressing  from an app will first return you to the last panel you were in. Just press  again to go to your main Home screen.

Grouping apps on the widget panel and launch bar

1. Press and hold an app, and then drag it over to another app to automatically create a folder.

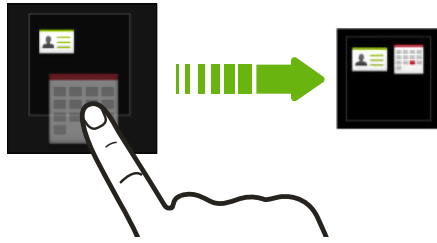

2. Tap the folder to open it.
3. Tap the folder window's title bar, and then enter a new folder name.
4. Add more apps into the folder. Tap **+**, select your apps, and then tap **Done**.



You can also add shortcuts to settings or information to a folder. Add a shortcut first to a widget panel, and then drag it over to the folder.

Removing items from a folder





1. On the launch bar or widget panel, tap a folder to open it.
2. Press and hold an app or shortcut in the folder, and then drag it out to .

Arranging apps



On the Apps screen, you can rearrange the apps.

1. From HTC BlinkFeed or any widget panel, tap .
2. Tap , and then choose how to arrange apps, such as alphabetically.
If you want to group apps into folders or rearrange them, select **Custom**.

Moving apps and folders

1. On the Apps screen, tap  > **Custom**.
2. Tap  > **Rearrange apps**.
3. Press and hold an app or folder, and then do one of the following:
 - Drag the app or folder to another position on the same page. Wait until you see the occupying icon move away before releasing your finger.
 - Drag the app or folder to the  or  arrow to move it to another page.
4. When you're done moving apps and folders, tap .

Grouping apps into a folder

1. On the Apps screen, tap  > **Custom**.
2. Tap  > **Rearrange apps**.
3. Press and hold an app, and then drag it over to another app to automatically create a folder.

4. To add more apps, drag each app over to the folder.
5. To name the folder, open the folder, tap its title bar, and then enter a folder name.
6. When done, tap ✓.

Removing apps from a folder

1. On the Apps screen, tap ▼ > **Custom**.
2. Tap ⋮ > **Rearrange apps**.
3. Tap the folder to open it.
4. Press and hold an app, and then drag it out to the Apps screen. Wait until you see the occupying icon move away before releasing your finger.
5. When you're done removing apps, tap ✓.

Hiding or unhiding apps



1. On the Apps screen, tap ⋮ > **Hide/unhide apps**.
2. Select the apps you want to hide, or clear their check boxes to unhide them.
3. Tap **Done**.

HTC BlinkFeed

What is HTC BlinkFeed?

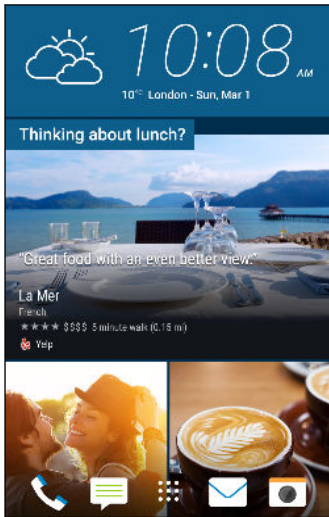
Get the latest news about your interests or status updates from your friends right on HTC BlinkFeed. Set up which social networks, news sources, and more will appear.



- Swipe up or down to browse stories on HTC BlinkFeed.
- Tap a tile to view the content.
- While viewing a news article, swipe left or right to see more stories.
- While in HTC BlinkFeed, you can press  or  to scroll to the top.
- Scroll to the top and pull down on the screen to manually refresh the stream.
- Swipe right on HTC BlinkFeed to open the slideout menu where you can choose the type of feeds or add your custom topics to display.



You'll see the clock widget on HTC BlinkFeed if you've set HTC BlinkFeed as the main Home screen.

Turning HTC BlinkFeed on or off

1. On the Home screen, slide two fingers together.



2. Tap .

3. Do one of the following:

- To turn on HTC BlinkFeed, swipe right until you see **+** **BlinkFeed**, then tap it.



- To turn off HTC BlinkFeed, swipe to the thumbnail and then tap **Remove**.

Restaurant recommendations

Can't think of what to eat? Get recommendations for restaurants nearby in HTC BlinkFeed.



- Make sure you've given HTC Sense Home permission to access your location. See [Setting up the HTC Sense Home widget](#) on page 35.
- Make sure you've added personalized content to HTC BlinkFeed. See [Ways of adding content on HTC BlinkFeed](#) on page 61.

1. On HTC BlinkFeed, swipe right to open the slideout menu.
2. Tap  > **Settings**.
3. Tap **Choose Highlights topics** and make sure **Mealtime recommendations** is selected.

To get restaurant recommendations, you'll need to actively use HTC BlinkFeed daily. Restaurant recommendations will show up as a tile in HTC BlinkFeed and also on your lock screen.

Viewing restaurant recommendations

View photos of the restaurant, get directions to the restaurant, and more.

1. When you see a restaurant recommendation tile, tap it to view more information.
2. You can do the following:
 - Tap the photo tile or **View Photos** to browse photos of the restaurant.
 - Tap the map icon or address to see the location in Google Maps™. From there, you can get directions.
 - If you see a phone number, tap the phone number to call the restaurant.
 - If you see numbers at the bottom, tap on a number to see alternative restaurant recommendations.

Ways of adding content on HTC BlinkFeed

Personalize HTC BlinkFeed to show articles and status updates from your favorite news sources and apps.

Adding sources to HTC BlinkFeed

Add news sources such as News Republic™ to select from a wide variety of news services.

1. On HTC BlinkFeed, swipe right to open the slideout menu.
2. Tap **+**, and then select the sources you want to add.

Selecting feeds

Discover stories and articles on HTC BlinkFeed.



You need to add a news source before you can select feeds.

1. On HTC BlinkFeed, swipe right to open the slideout menu.
2. Next to News Republic, tap **▼ > + Add topics**.
3. Swipe across the screen to browse the categories.
4. Select one or more feeds.

Showing content from your apps and social networks

See your friends' posts in social networks or show content from your HTC apps right on HTC BlinkFeed.





- You need to sign in to your social networks before you can post a status update from HTC BlinkFeed.
- When adding a social network to HTC BlinkFeed, you need to give HTC Sense permission to access it.

1. On HTC BlinkFeed, swipe right to open the slideout menu.
2. Tap , and then select the apps and social networks you like.



Searching and adding a topic of interest

Looking for a more specific topic? Search for and select topics of interest to display them on HTC BlinkFeed.

1. On HTC BlinkFeed, swipe right to open the slideout menu.
2. Next to News Republic, tap  >  **Add topics**.
3. Tap , and then tap **Search topics and providers** and enter keywords of what you're looking for.
4. Tap a result to add it to My topics in the News Republic app. You can also tap **Show feeds from RSS providers** to see RSS feeds related to the topic. If you don't see the tile, scroll up.

Subscribing to foreign news sources

Want to keep up to date on current events in more than one region? You can have news sources from different countries appear on HTC BlinkFeed.

1. On HTC BlinkFeed, swipe right to open the slideout menu.
2. Next to News Republic, tap  >  **Add topics**.
3. Tap  next to the name of the local or region, and then select another one.
4. Select the feeds to add.

Making reading more convenient

Make reading HTC BlinkFeed content more convenient with resizable fonts or night reading mode.

1. On HTC BlinkFeed, tap an article to open it in News Republic.
2. Tap , and do one of the following:
 - Tap **Night mode** to switch to night reading mode.
 - Tap **Font size**, and then select a font size.

Customizing the Highlights feed

The Highlights feed displays a mix of top trending articles and status updates from the feed sources you added. You can set the Highlights feed to only show items from your favorite news sources and apps.

1. On HTC BlinkFeed, swipe right to open the slideout menu.
2. Tap  > **Settings** > **Choose Highlights topics**.
3. Select the feed sources you want to appear in Highlights.

Posting to your social networks

You can easily post a status update from HTC BlinkFeed.







- You need to sign in to your social networks before you can post a status update from HTC BlinkFeed.
- When adding a social network to HTC BlinkFeed, you need to give HTC Sense permission to access it.

1. On HTC BlinkFeed, swipe right to open the slideout menu.
2. Tap  > **Compose**, and then choose a social network.
3. Compose your status update and post it on your social network.

Removing content from HTC BlinkFeed

Whether it's a tile or an entire feed, you can remove content you don't want to see on HTC BlinkFeed.

- To remove a tile, press and hold the tile you want to remove, and then tap **Remove**.
- To remove a feed source, in the slideout menu, next to News Republic tap  >  **Add topics**. Then tap any tile marked with  to remove it.
- To remove social networks or apps from HTC BlinkFeed, in the slideout menu, tap . Then uncheck the social networks or apps you want to hide from HTC BlinkFeed.

Camera









Camera basics

Camera screen

Take great photos and videos with the camera.

On the Home screen, tap the camera icon to open the Camera app. You'll see **Camera** mode, which is the default capture mode.



	Switch between flash modes.
	Toggle HDR mode on and off.
	Switch between the front camera and main camera.
	Toggle Zoe camera mode on and off.
	Choose from more basic and advanced camera settings.
	Select a camera mode.
	Capture a video.
	Capture a photo.
	Tap to view the last photo or video taken.

Choosing a capture mode

Switch to a capture mode to use for taking photos or videos.

On the Viewfinder screen, tap , and then tap a capture mode.

You can also just swipe across the Viewfinder screen to switch between capture modes:

- In landscape view, swipe from the top or bottom edge of the screen.
- In portrait view, swipe from the left or right edge of the screen.

Zooming

Before taking a photo or video, slide two fingers apart to zoom in or together to zoom out.

Turning the camera flash on or off

Tap the flash icon to choose a flash setting.

When using  or , the camera intelligently sets the best flash brightness for your photo.

Taking a photo

1. On the Home screen, tap the camera icon to open the Camera app.
2. Switch to **Camera** mode, if you're not in this mode. See [Choosing a capture mode](#) on page 65 for details.
3. Point the camera at what you want to capture. The camera adjusts the focus automatically as you move it.
4. When you're ready to take the photo, tap .

Tips for capturing better photos

To get better captures with the Camera app, here are some tips on what to do while taking your shots.

Improving focus

- HTC One X9 has autofocus, which works best on a subject that is not moving too much. To change the focus, on the Viewfinder, tap the subject you want to focus on.
- If the subject is moving, on the Viewfinder, press and hold the subject to lock the focus.





Taking well-lit photos

- HTC One X9 automatically adjusts the focus and exposure. If the image appears underexposed or that it appears dark on the Viewfinder, tap a part of the image that is in shadow. Conversely, tap a well-lit object in the image if the image seems to be overexposed. Focus on an object with a neutral tone for a balanced exposure. Keep in mind that tapping on another object may shift the focus from your subject.
- If there are parts of the image that are in shadows and others are in highlights, use HDR to capture multiple shots of different exposures and combine them into one shot. Keep HTC One X9 steady or place it on a level surface when using HDR.
- When taking a panoramic photo, consider the whole scene and focus on an object that has a neutral tone to help keep the exposure balanced in the composite image.

Other tips

- In Camera settings, tap **Grid** to help frame the subject better or improve the composition.
- After capturing the photo, you can fine-tune the contrast, brightness, and other settings in Photo Editor.

Recording video



1. On the Home screen, tap the camera icon to open the Camera app.
2. Switch to **Camera** mode, if you're not in this mode. See [Choosing a capture mode](#) on page 65 for details.
3. When you're ready to start recording, tap .
4. Change focus to a different subject or area by just tapping it on the Viewfinder screen.
5. Tap the flash icon to turn the flash on or off.
6. Tap  to pause the recording, and then tap  to resume.
7. To stop recording, tap .

Setting the video resolution

1. Switch to **Camera** mode.
2. Tap .
3. Tap **Video Quality**, and then choose a video resolution.

Taking a photo while recording a video—VideoPic

1. On the Home screen, tap the camera icon to open the Camera app.
2. Switch to **Camera** mode, if you're not in this mode. See [Choosing a capture mode](#) on page 65 for details.
3. Tap  to start recording.



4. While recording, tap  whenever you want to capture a still shot.
5. Tap  to stop recording.



Using the volume buttons for taking photos and videos

In the Camera app, you can set the VOLUME buttons to function as the shutter release or zoom controls.

1. On the Home screen, tap the camera icon to open the Camera app.
2. Tap  > **General settings** > **Volume button options**.
3. Choose how you want to use the volume buttons when you're in the Camera app.

Closing the Camera app

To give you a full view of the Viewfinder screen, HTC One X9 replaces , , and  with small dots.

Tap a dot to show these buttons again, and then tap  or  to close the Camera app and return to the Home screen or the previous screen.

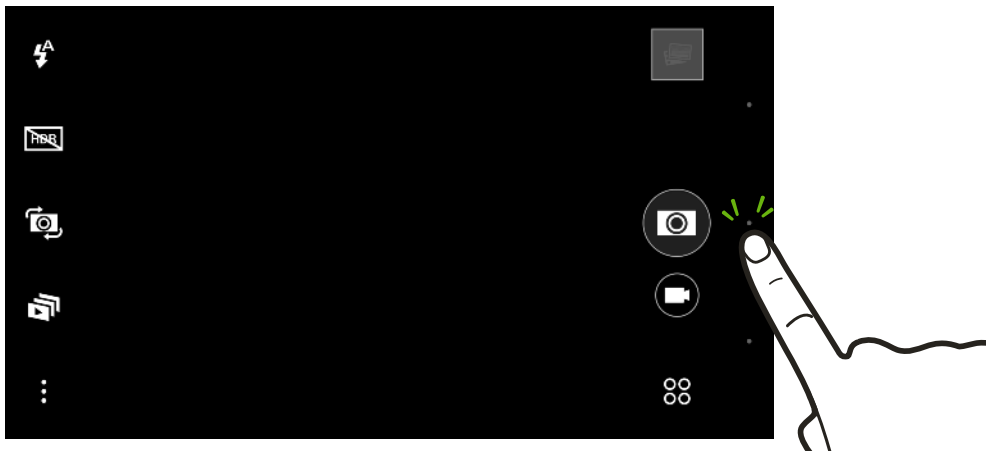

Taking continuous camera shots

Do you want to take photos of moving subjects? Whether it's your kid's football game or a car race, you can capture the action.

1. On the Home screen, tap the camera icon to open the Camera app.
2. Switch to **Camera** mode, if you're not in this mode. See [Choosing a capture mode](#) on page 65 for details.

3. Press and hold the onscreen shutter button .

The camera takes consecutive shots of your subject.



4. Choose what you want to do with the continuous shots:
 - To keep just one photo, select the photo that you like the most, and then tap **Best shot**.
 - Tap **Delete**, select the unwanted shots, and then tap **Delete** to save only the remaining shots.
 - To save the whole batch of shots, just press **<**.

Using HDR

When shooting portraits against a bright background, use HDR, short for High Dynamic Range, to capture your subjects clearly. HDR brings out the details of both the highlights and shadows, even in high contrast lighting.



HDR works best when your subject is steady. The camera takes multiple shots at different exposure levels and combines them into one enhanced photo.



1. On the Home screen, tap the camera icon to open the Camera app.
2. Switch to **Camera** mode, if you're not in this mode. See [Choosing a capture mode](#) on page 65 for details.
3. Make sure that  is selected. If not tap  to change it.
4. Tap .

Recording videos in slow motion

Relive high speed action bit by bit and add a touch of suspense to your videos.



Audio is recorded when you're in this mode, but will only be available when video is played back in normal speed.

1. On the Home screen, tap the camera icon to open the Camera app.
2. Tap  > **Slow motion**.
3. Tap  to start recording.
4. To stop recording, tap  again.

Selfies and people shots

Tips for taking selfies and people shots

Do you want yourself, your family, and friends to look best in your shots? Here are some camera options you can adjust or select before taking selfies and people shots.

Live Makeup for selfies

Touch up your skin with Live Makeup before taking your selfie. See [Applying skin touch-ups with Live Makeup](#) on page 69.

Angle of selfies

Do you want the angle of your shots to look exactly the same as how you see yourself on the Viewfinder screen?

1. Switch to **Selfie** mode. To find out how to switch between capture modes, see [Choosing a capture mode](#) on page 65.
2. Tap  > **Camera options**.
3. Select the **Save mirror image** option.

Applying skin touch-ups with Live Makeup

Touch up your skin before taking your selfie. Live Makeup smoothens your skin in real time.



1. On the Home screen, tap the camera icon to open the Camera app.
2. Switch to **Selfie** mode. To find out how to switch between capture modes, see [Choosing a capture mode](#) on page 65.
3. To change the skin smoothing level, drag the slider across the adjustment bar.



The adjustment bar is shown on the Viewfinder screen by default. To hide it, tap , and then clear the **Live Makeup** option.

Using Auto Selfie

Keep still to take an auto selfie—or just smile! You just need to turn this feature on in the camera settings.

1. On the Home screen, tap the camera icon to open the Camera app.
2. Switch to **Selfie** mode. To find out how to switch between capture modes, see [Choosing a capture mode](#) on page 65.
3. Tap  > **Camera options**.
4. Select the **Auto Selfie** option, and then press .

5. Pose and frame yourself on the Viewfinder screen.
6. To take your selfie automatically, look at the front camera, and then:
 - Stay still until the white box turns green on the Viewfinder screen.
 - Or smile at the camera. Hold your smile for a few seconds until your shot is taken.

Using Voice Selfie

Voice Selfie lets you easily take photo or video selfies using voice control. You just need to turn this feature on in the camera settings.



This feature may not be available in all languages.



1. On the Home screen, tap the camera icon to open the Camera app.
2. Switch to **Selfie** mode. To find out how to switch between capture modes, see [Choosing a capture mode](#) on page 65.
3. Tap **⋮** > **Camera options**.
4. Select the **Voice Selfie** option, and then press **<**.
5. Pose and frame yourself on the Viewfinder screen.
6. Look at the front camera, and then:
 - Say **Cheese** or **Capture** to take a photo selfie.
 - Say **Action** or **Rolling** to record a video selfie.



You can also use voice capture with the main camera. Switch to **Camera** mode, and then turn on **Voice capture** in the camera settings. Voice capture may not be available in all languages.

Taking photos with the self-timer

When you use the self-timer, the Camera app counts down before taking the shot. You can set the countdown time.

1. On the Home screen, tap the camera icon to open the Camera app.
2. Choose a capture mode you want to use. To find out how to switch between capture modes, see [Choosing a capture mode](#) on page 65.
3. Depending on your selected capture mode, do one of the following:
 - Tap  if you see this icon, and then tap the countdown time that you want.
 - Tap **⋮** > **Self-timer**, and then drag the slider to set the countdown time.
4. To start the timer, tap . The camera takes the photo after the countdown.

Zoe camera



Using Zoe camera

Get more than just a still photo. With Zoe camera, capture living moments as a 3-second video clip and 3 still shots.

The 3 still photos are embedded in the video clip and can be viewed or saved as separate images using Gallery.



Some camera features are not available when you're using Zoe camera, such as zooming.

1. On the Home screen, tap the camera icon to open the Camera app.
2. Switch to **Camera** mode, if you're not in this mode. See [Choosing a capture mode](#) on page 65 for details.
3. On the Viewfinder screen, tap  to switch Zoe camera on.
4. When you're ready to capture, tap .

When you see the shutter release icon slowly turn blue , continue holding the phone steady as the camera captures the 3 shots and 3-second video.



When taking your shots with a 3-second video clip using the Zoe camera, it's good practice to:

- Keep HTC One X9 steady to capture moving subjects against a static background scene.
- When taking a group photo, ask your subjects to hold the pose until you have finished capturing.



Panoramic shots

Taking a panoramic photo

Get a wider shot of landscapes in one sweep.



Some camera features are not available when you're in Sweep panorama mode, such as zooming.

1. On the Home screen, tap the camera icon to open the Camera app.
2. Tap  > **Panorama**.
3. When you're ready to take the shot, tap .
4. Pan left or right in either landscape or portrait view. Hold HTC One X9 as smoothly as you can to automatically capture frames.



You can also tap  to stop capturing anytime.

The camera stitches the frames into a single photo.

Hyperlapse

Recording a Hyperlapse video

Want to compress a long video into a smooth, entertaining Hyperlapse video? Use the Hyperlapse camera mode to speed videos up to 12 times.

1. On the Home screen, tap the camera icon to open the Camera app.
2. Tap  > **HyperLapse**.
3. When you're ready to start recording, tap .
4. Change focus to a different subject or area by tapping it on the Viewfinder screen.
5. Tap the flash icon to turn the flash on or off.
6. To stop recording, tap  again.

Pro mode



Manually adjusting camera settings

Want to have expert command of your camera settings for different environments or lighting conditions? Use Pro mode to manually adjust the values for settings like white balance, exposure, ISO, and more.

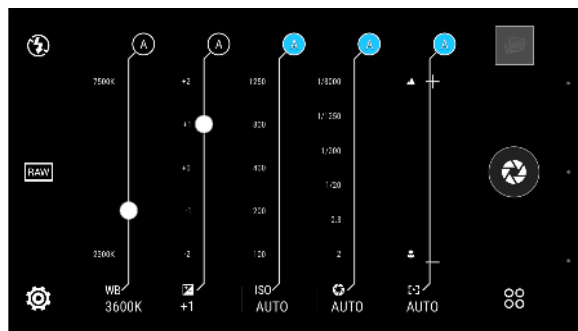
1. On the Home screen, tap the camera icon to open the Camera app.
2. Tap  > **Pro**.
3. Tap a setting, and then drag its slider to make adjustments.



Tap a setting again to hide the slider.

4. To change a setting back to auto, tap .
5. When you're ready to take a photo, tap .





Taking a RAW photo

Want to keep more detail in your shots, or fix the lighting in post processing? With Pro mode, you can take photos that will be saved as RAW image files in DNG format, along with a JPG compressed version.

The RAW file contains more image information for processing, and you can use the Photo Editor app's RAW enhancement tool or a photo editor on your computer to enhance your photos and get the look you want.



When you take a RAW photo, both a RAW and JPG file are saved. The RAW and JPG files will appear as a single thumbnail in Gallery.

1. On the Home screen, tap the camera icon to open the Camera app.
2. Tap  > **Pro**.
3. Make sure that  is selected. If not tap  to change it.
Select  if you only want to save a JPG compressed version.
4. Tap .

How does the Camera app capture RAW photos?

The Camera app captures a photo in both the DNG RAW format and JPG format.

Digital Negative (DNG) is an open-standard lossless RAW image format. Since a RAW file is typically 2 to 6 times larger than a JPEG file and is not viewable in most photo viewer apps, a photo is captured in both DNG and JPG formats. When you use the HTC Gallery app, you'll see the JPG copy of the photo, with a  icon to indicate that there is a DNG RAW file of that photo.

RAW photos are not processed when captured to preserve most of the original image data—such as dynamic range—so you can adjust lighting or make professional adjustments using advanced editing tools. After making adjustments, save the RAW photo as a JPG file if you want to print or share it.

Gallery

Viewing photos and videos in Gallery

Reminisce about good times. Use Gallery to view all your photos and videos. View them by time or album. When viewing photos and videos in full screen, the onscreen navigation buttons will be hidden. Tap the screen to see Gallery controls and onscreen navigation buttons.

Viewing photos and videos organized by time



Switch to Timeline view when you want to view your photos and videos according to when they were taken.

1. From the Home screen, tap , and then find and tap **Gallery**.

2. Tap  > **Timeline**.

You'll then see tab icons for switching between different layouts.

3. Do one of the following:

- Tap  to see photos and videos in a grid layout.
- Tap  to see photos and videos organized by events.
- Tap  to see photos and videos organized by year, then tap a month to see the shots you've taken at that time.

4. Tap a photo or video to see it in full screen.



You can also slide two fingers together or apart on the screen to scroll through the Grid, Events, and Year layouts.

Viewing photos and videos by album

1. From the Home screen, tap , and then find and tap **Gallery**.

2. Tap  > **Albums**.

3. Tap a tile to open an album.

4. Tap a photo or video to see it in full screen.



Viewing your favorite photos

Easily see all your favorite photos in one place. You can add photos to the My favorites album.

- To add a photo, find and view the photo in full screen, tap the photo, and then tap  > **Favorite**.
- To view these favorite photos, open the My favorites album.
- To remove a photo from the My favorites album, press and hold the thumbnail and then tap **Remove**.

Showing or hiding albums

Have too many albums cluttering up Gallery? You can choose to show or hide albums.

1. In Gallery, tap  > **Timeline** or **Albums**.
2. Tap  > **Show/hide albums**.
3. Choose which albums you'd like to show or hide.

Renaming an album





If you have created albums to organize photos, you can rename these albums.

1. In Gallery, tap  > **Albums**.
2. Press and hold the album that you want to rename.
3. Tap **Rename**.



Some albums, such as Camera shots and Screenshots, cannot be renamed.





Adding photos or videos to an album

1. From the Home screen, tap , and then find and tap **Gallery**.
2. Tap , and then choose how you want to view your photos and videos.
3. Open a group of photos and videos, such as an event in Timeline view or an album.
4. Tap  > **Add to album**.
5. Select the photos or videos you want to add, and then tap **Next**.
6. Create an album or select an album that you've already created in Gallery. To create a new album to move or copy to, tap .





To add a single photo or video to an album, press and hold the photo or video. Tap **Add to album**, and then select the destination album or create a new album.

Copying or moving photos or videos between albums

1. From the Home screen, tap , and then find and tap **Gallery**.
2. Tap  > **Albums**.
3. Tap a tile to open an album.
4. Tap  > **Move to** or **Copy to**.
5. Select the photos or videos you want to move or copy and then tap **Next**.
6. Select an album to move or copy the photos or videos to. To create a new album to move or copy to, tap .

Searching for photos and videos

You can search the Gallery using photo locations and specific dates.



1. From the Home screen, tap , and then find and tap **Gallery**.
2. Tap .
3. In the search field, type:
 - A location associated with the photo or video you're looking for.
 - A specific date. You must use the same date format as that set in **Settings > Date & time**, such as 01/13/2015.
4. Tap .
5. Select what you want from the results.



Changing the video playback speed

Want to add a cinematic flair to your video by slowing down a particular scene? You can vary the playback speed of a selected section of a slow motion video.



You can only change the video playback speed of videos captured using slow motion in the Camera app.







1. In Gallery, open the video you want to play in full screen. You can identify slow motion videos by the  icon on the thumbnail.
2. Tap  to switch between normal and slow motion playback.
3. To adjust the playback speed of the video, tap  > **Edit** > **Adjust playback speed**.
4. Frame the sequence you want to slow down by moving the left and right sliders.
5. Drag the slider up or down to choose how fast you want the sequence to play.

6. Tap  to watch the result.
7. Tap .

The edited video is saved as a copy. The original video remains unedited.

Viewing Zoe photos in Gallery

Zoe™ photos help you relive your memories by recording sound and motion. Watch these living memories and share them with your family and friends from Gallery.



1. From the Home screen, tap , and then find and tap **Gallery**.
2. Find the Zoe photo you want. Zoe photos are marked with a .
3. To view a Zoe photo, tap it.
 - Tap  to watch the Zoe photo come alive.
 - Tap  to see the available still photos. While viewing, tap a frame and then tap , , or  to save, share, or edit it.

Trimming a video

1. In Gallery, open the video you want to play in full screen.
2. Tap the onscreen controls to pause or resume playback, adjust the volume, and more.



Tap  to share the video on your home network.

3. To trim the video, tap  > **Edit**.
4. Drag the trim sliders to the part where you want the video to begin and end.
5. Tap  to preview your trimmed video.
6. Tap .



The trimmed video is saved as a copy. The original video remains unedited.



Editing a Hyperlapse video

Create a dynamic Hyperlapse video that has varying speed at different parts of the video.





If you don't see this feature in Gallery, download and install the latest Zoe app update.



1. From the Home screen, tap , and then find and tap **Gallery**.
2. Tap a video that was captured in Hyperlapse mode—marked with the  icon, and then tap .

You can also tap any regular video, tap the screen to display the onscreen controls, and then tap  to make the video into a Hyperlapse video.
3. Move the left and right sliders to divide the video into segments so that you can set the speed per segment. You can have up to 3 segments with varying speed.
4. To adjust the speed per segment, tap the segment, and then tap the speed that you want.
5. Tap  to watch the result.
6. Tap  when done.

Viewing, editing, and saving a Zoe highlight

When you view a group of photos and videos such as in an album, Gallery automatically composes a Zoe highlight. A Zoe highlight is a collection of clips—which can be photos, videos, or both—that Gallery has preselected, with added background music and special effects. You can edit the Zoe highlight, and then save it as a video.

1. From the Home screen, tap , and then find and tap **Gallery**.
2. Tap , and then choose how you want to view your photos and videos.

If you are in Timeline view, you need to go to the Events  or Year  tab.
3. Tap a tile to open a group of photos and videos. You'll then see a preview of the Zoe highlight play automatically.
4. Tap  to edit the Zoe highlight.

You can add, change, or rearrange the clips, choose a theme, or change the background music.
5. When you're done editing the Zoe highlight, tap **Save** to save it as a video.

You'll find the saved video in the Zoe Highlights album.

Photo Editor

Basics

Choosing a photo to edit

You can select photos to edit from Photo Editor or Gallery.





1. From the Home screen, tap , and then find and tap **Photo Editor**.
2. Tap **Gallery** to open an existing photo on your phone, and then browse for the item to edit.
Or, tap **Camera** if you want to take a new photo to edit.



You can also tap  while viewing a photo in full screen from the Gallery app.

Adjusting your photos



Use the available adjustment tools to crop, rotate, flip, or straighten photos.







1. From Photo Editor, choose the photo you want to edit.
See [Choosing a photo to edit](#) on page 79 to find out how.
2. Tap  to open the slideout menu.
3. In the slideout menu that opens, tap **Essentials** > .
4. Choose to rotate, crop, flip, or straighten the photo.
5. Tap  and make more adjustments, if needed.
6. Press  to return to the Essentials screen.
7. Tap  to save changes.

Except for when applying rotation, edited photos are saved as new photos. The original remains unedited.







Drawing on a photo

Scribble on your photos for fun or to highlight an interesting part.



1. From Photo Editor, choose the photo you want to edit.
See [Choosing a photo to edit](#) on page 79 to find out how.
2. In the slideout menu that opens, tap **Flair** > .
3. Drag the stroke slider to adjust the stroke thickness.
4. Tap  to open the toolbar, choose a pen type, and then tap  to hide the toolbar.

5. Choose a pen color from the color bar.
6. Draw on the photo.
You can tap  to switch to full screen view.
7. To undo or redo an action, open the toolbar, and then tap  or .
- Or, you can use the eraser from the toolbar to remove specific parts of your drawing.
8. Tap .
9. Tap , and then tap  to toggle between the before and after photos.
10. Tap  to save changes.
The edited photo is saved as a new photo. The original photo remains unedited.

Applying photo filters

1. From Photo Editor, choose the photo you want to edit.
See [Choosing a photo to edit](#) on page 79 to find out how.
2. Tap  to open the slideout menu.
3. In the slideout menu that opens, tap **Essentials**.
4. Tap , and then choose one of the available filters.
5. Tap .
6. Tap , and then tap  to toggle between the before and after photos.
7. Tap  to save changes.
The edited photo is saved as a new photo. The original photo remains unedited.

Creating and applying a custom filter

1. From Photo Editor, choose the photo you want to edit.
See [Choosing a photo to edit](#) on page 79 to find out how.
2. Tap  to open the slideout menu.
3. In the slideout menu that opens, tap **Essentials**.
4. Tap , and then scroll to the end of the predefined filters bar.
5. Tap **Custom**.
6. Make changes to the filter by adjusting the controls on exposure, saturation, white balance, and more.
7. If you need to rearrange the order of your settings to achieve a particular effect, you can press and hold a setting and drag it to a new position.
Rearranging the settings may reset values to the default.
8. Tap .

9. Press < to return to the Essentials screen.
10. Tap ✓ to save changes.

The edited photo is saved as a new photo. The original photo remains unedited.

Retouching photos of people

1. From Photo Editor, choose the photo you want to edit.
See [Choosing a photo to edit](#) on page 79 to find out how.
2. Tap ≡ to open the slideout menu.
3. In the slideout menu that opens, tap **Touch up**.
4. Choose a facial touch-up to apply, and then customize its settings.
5. Tap >.
6. Tap ▲, and then tap ✱ to toggle between the before and after photos.
7. Tap ✓ to save changes.

The edited photo is saved as a new photo. The original photo remains unedited.

Fixing red eye in photos

1. From Photo Editor, choose the photo you want to edit.
See [Choosing a photo to edit](#) on page 79 to find out how.
2. Tap ≡ to open the slideout menu.
3. In the slideout menu that opens, tap **Essentials**.
4. Tap 👁, and then tap >.
5. Tap ✓ to save changes.

The edited photo is saved as a new photo. The original photo remains unedited.

Editing continuous shots



GIF creator

Create an animated gif that you can quickly upload and share.



This feature is available for burst shots captured on HTC One X9. You can identify burst shots by the  icon on the thumbnail.

1. From Photo Editor, choose the photo you want to edit.
See [Choosing a photo to edit](#) on page 79 to find out how.
2. Tap ≡ to open the slideout menu.









3. In the slideout menu that opens, tap **Effects** > . You'll see an animation of the frames.
4. Drag the trim sliders to the part where you want the animated gif to begin and end.
5. Tap .
6. On the next screen, you can choose the direction you want the animation to play, set the speed of the animation, choose which frames you want to include, and more.
7. Tap  when done.
8. Select the file quality of your animation, and then tap **OK**.

The animation is saved as a gif. You can identify a gif by the  icon on the thumbnail in Gallery.

Creative effects

Shapes

Add some pattern to your photo by adding and blending shapes.

1. From Photo Editor, choose the photo you want to edit.
See [Choosing a photo to edit](#) on page 79 to find out how.
2. Tap  to open the slideout menu.
3. In the slideout menu that opens, tap **Effects** > .
4. Choose a shape to add to your photo.
5. Select a shape color by dragging the color slider.
6. Drag the shape to move it.
7. Drag your fingers apart or together on the shape to adjust its size.
8. Press and hold the shape with two fingers and then drag your fingers in a circular motion to rotate it.
9. Tap  to open the toolbar.
10. Tap , choose a different blending option for the selected layer, and then tap .
11. Tap  > , and then drag the slider to adjust the shape's opacity.
12. If you want to adjust your photo to blend with the shape, tap  to switch from the shape layer to the photo layer.

13. Tap a setting to adjust its values, and then tap > .



14. Tap ✓ to save changes.

The edited photo is saved as a new photo. The original photo remains unedited.

Photo Shapes

Photo Shapes lets you add a shape to your image and fill it with another photo.

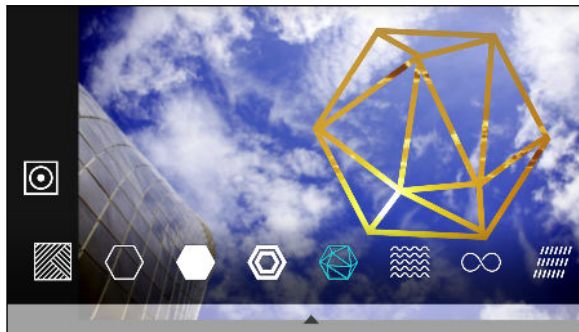

1. From Photo Editor, choose the photo you want to edit.
See [Choosing a photo to edit](#) on page 79 to find out how.
2. Tap ≡ to open the slideout menu.
3. In the slideout menu that opens, tap **Effects** > ▲.
4. Choose a second image to be the fill for your selected shape.
5. Choose a shape to add to your photo.
6. Tap 📍 to switch to the shape layer. You should see the shape layer icon 📍.
7. Drag the shape mask to move it.

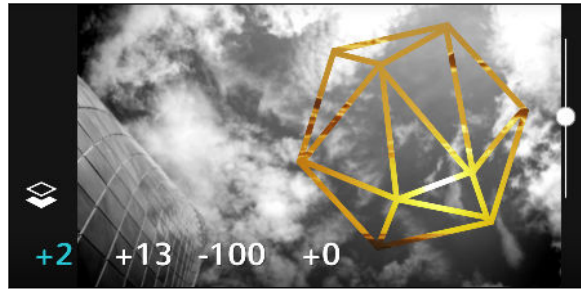

8. Drag your fingers apart or together on the shape mask to adjust its size.
9. Press and hold the shape mask with two fingers, and then drag your fingers in a circular motion to rotate it.
10. Tap 📍 to return to the image layer 📍, and then drag your fingers apart or together on the image to adjust the image size inside the mask.
11. Tap ▲ to open the toolbar.
12. Tap ●, choose a different blending option for the selected layer, and then tap > .
13. Tap ▲ > ✎, and then tap a setting to adjust its values.

- If you want to adjust your photo to blend with the image fill, tap  to switch from the image fill layer to the photo layer.











- Tap a setting and drag the slider to adjust its values, and then tap .
- Tap  to save changes.

The edited photo is saved as a new photo. The original photo remains unedited.

Prismatic

Got a bright and colorful image? Use Prismatic effect for fresh crystal prism patterns.

- From Photo Editor, choose the photo you want to edit.
See [Choosing a photo to edit](#) on page 79 to find out how.
- Tap  to open the slideout menu.
- In the slideout menu that opens, tap **Effects** > .
- Choose a prismatic pattern to apply to your photo.
- Tap  to switch to the shape layer. You should see the shape layer icon .
- Drag the shape to move it.
- Drag your fingers apart or together on the shape to adjust its size.
- Press and hold the shape with two fingers, and then drag your fingers in a circular motion to rotate it.
- Tap  to return to the image layer , and then drag your fingers apart or together on the image to adjust its size.
- Tap  to open the toolbar.

11. Tap , adjust the settings for your photo layer, and then tap .





12. Tap  to save changes.





The edited photo is saved as a new photo. The original photo remains unedited.

Double Exposure

With Double Exposure, combine and blend two photos and create something surreal.

1. From Photo Editor, choose the photo you want to edit.
See [Choosing a photo to edit](#) on page 79 to find out how.
2. Tap  to open the slideout menu.
3. In the slideout menu that opens, tap **Effects** > .
4. Choose your second image. This will be your top layer .



5. Drag the layer to move it.
6. Drag your fingers apart or together on the layer to adjust its size.
7. Tap  to open the toolbar.
8. Tap , choose a different blending option for the selected layer, and then tap .
9. Tap  > , tap a setting, and then drag the slider to adjust its values.

- If you want to adjust your background layer to blend with the top layer, tap  to switch to the background layer.







- Tap a setting and drag the slider to adjust its values, and then tap .
- Tap  to save changes.



The edited photo is saved as a new photo. The original photo remains unedited.

Elements

Add animated elements to your photo.

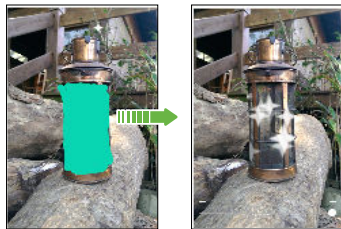
- From Photo Editor, choose the photo you want to edit.
See [Choosing a photo to edit](#) on page 79 to find out how.
- Tap  to open the slideout menu.
- In the slideout menu that opens, tap **Effects** > .
- Tap an element type to apply to your photo.
- Tap  to open the toolbar.
- Tap , draw an animation path or area for the selected effect, and then tap .



- Tap  to adjust the animation speed and intensity.
- Press and hold an area with two fingers, and then drag your fingers in a circular motion to rotate the animation.
- When you are satisfied with the result, tap  and choose to save as a photo or video.

Face Fusion

Wonder what you would like if you shared the same features as another person? Face Fusion uses a person's photo and a target face to merge the two photos into one.



To use Face Fusion, be sure that:

- The faces in each photo have to be 100 x 100 pixels or larger in size.
- Facial shots are without glasses and are not covered by hair, a hat, or any other item.
- Subjects should look towards the camera for best results.

1. From Photo Editor, choose the photo you want to edit.

See [Choosing a photo to edit](#) on page 79 to find out how.

2. Tap to open the slideout menu.
3. In the slideout menu that opens, tap **Effects** > .
4. Tap and then browse to the photo that you want to merge with.
5. Drag the slider to apply Face Fusion to the image.

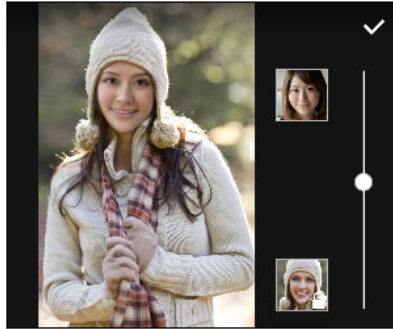

To choose another target face, just tap the thumbnail of the target person and browse to a new photo.

6. When you are satisfied with the result, tap and choose to save as a photo or video.

RAW photos

Enhancing RAW photos

After capturing RAW photos, you can do some basic enhancements to them on HTC One X9.

1. From the Home screen, tap , and then find and tap **Photo Editor**.
2. Tap **Gallery** and select the RAW photo you want to enhance.
3. Tap .
4. Tap when done.

Phone calls



Phone calls

Making a call with Smart dial

You can either dial a number directly, or use Smart dial to quickly place a call. Smart dial searches and calls a stored/synced contact or a number from your call history.

1. On the Home screen, tap the phone icon to open the **Phone** app.
2. Enter the phone number or first few letters of the contact's name to see the top matching contact.
3. If there are a number of matches found (for example, 8 matches), tap the number to see all the matches.
4. Tap the contact you want to call.



- To check other phone numbers associated with the contact, tap  beside the contact name.
- If the phone number has an extension, tap  after connecting to the main line and then dial the extension number.

5. Tap the call button that corresponds to the card you want to use.

Making a call with your voice

Call a contact hands-free using your voice.

1. On the Home screen, tap the phone icon to open the **Phone** app.
2. Tap .
3. Say the name of contact you want to call. For example, say "Call [person's name in phonebook]."
4. Follow screen instructions to make the call.

Dialing an extension number

To skip voice prompts when dialing an extension number, do one of the following:

- After dialing the main number, press and hold *. A comma (,) is added to the number you are dialing. Enter the extension number, and then tap the call button. You will be connected to the mainline and then to the extension number.
- After dialing the main number, press and hold # to add a semicolon (;). Enter the extension number after the semicolon, and then tap the call button. After connecting to the main line, tap **Send** to dial the extension number.

You can save phone numbers with an extension in the People app.

Returning a missed call

You'll see the missed call icon  in the status bar when you miss a call.

1. Slide the Notifications panel open to check who the caller is.
2. To return the call, tap **Call back**.

If you have multiple missed calls, tap the missed calls notification to open the Call History tab.

Speed dial

Use Speed dial to call a phone number with a single tap.

1. On the Home screen, tap the phone icon to open the **Phone** app.
2. Tap **:** > **Speed dial** > **+**. You can also press and hold an unassigned key on the dialpad, and then tap **Yes**.
3. Select a contact from the list.
4. On the Speed dial screen, choose the phone number of the contact to use, and a speed dial key to assign.
5. Tap **Save**.

To use Speed dial, press and hold the speed dial number you want to call. Then tap the call button that corresponds to the card you want to use.

Calling a number in a message, email, or calendar event

When you receive a text message, email, or calendar event that has a phone number in it, you can just tap the number to place a call.

Making an emergency call

In some regions, you can make emergency calls from HTC One X9 even if the nano SIM card has been blocked or if you don't have one installed.



If you don't have a network signal, you won't be able to make an emergency call.

1. On the Home screen, tap the phone icon to open the **Phone** app.
2. Dial the emergency number for your locale, and then tap **Call**.



If you've enabled but forgotten your lock password or lock pattern, you can still make emergency calls by tapping **Emergency call** on the screen.

Receiving calls



When you receive a phone call from a contact, the Incoming call screen appears.



HTC One X9 will automatically adjust the ringtone volume when you use the polite ringer and pocket mode features.

Answering or rejecting a call

Do one of the following:

- Tap **Answer** or **Decline**.
- If you've set up a lock screen, drag  or  upwards.

Muting the ringing sound without rejecting the call

Do one of the following:

- Press the VOLUME DOWN or VOLUME UP button.
- Press the POWER button.
- Place HTC One X9 face down on a level surface.





If **Flip to mute** option in **Sound & notification** settings is set to **Mute once**, HTC One X9 will still ring when there are subsequent incoming calls.

What can I do during a call?

When a call is in progress, you can turn the speakerphone on, place the call on hold, and more.

Putting a call on hold

To put the call on hold, tap  > **Hold**. The status bar then displays the hold call icon .

To resume the call, tap  > **Unhold**.

Switching between calls

If you're already in a call and you accept another call, you can switch between the two calls.

1. When you receive another call, tap **Answer** to accept the second call and put the first call on hold.
2. To switch between the calls, tap the person you want to talk to on the screen.

Turning the speakerphone on or off during a call



To decrease potential damage to your hearing, do not hold HTC One X9 to your ear when the speakerphone is on.

- On the call screen, tap . The speakerphone icon appears in the status bar.
- To turn the speakerphone off, tap .

Muting the microphone during a call

On the call screen, tap to toggle between turning the microphone on or off. When the microphone is turned off, the mute icon appears in the status bar.

Ending a call

Do one of the following to end the call:

- On the call screen, tap **End Call**.
- Slide the Notifications panel open, then tap **End Call**.

Setting up a conference call

Conference calling with your friends, family, or co-workers is easy. Make or accept a call, and then simply dial each subsequent call to add it to the conference.



Make sure that you have conference calling service activated. Contact your mobile operator for details.

1. Make a call to the first conference call participant.
2. When connected, tap > **Add call**, and then dial the number of the second participant. The first participant is put on hold.
3. When connected to the second participant, tap .
4. To add another participant, tap , and then dial the number of the contact.
5. When connected, tap to add the participant to the conference call. Tap to access options such as ending the call with a participant.
6. To end the conference call, tap **End Call**.

Call History

Use Call History to check missed calls, your dialed numbers, and received calls.

1. On the Home screen, tap the phone icon to open the **Phone** app.
2. Swipe to view the Call History tab.
3. Do one of the following:
 - Tap a name or number in the list to call.
 - Press and hold a name or number in the list to display the options menu.
 - Tap ▼ to display just a particular type of call such as missed calls or outgoing calls.

Adding a new phone number to your contacts from Call History

1. On the Call History tab, tap + next to the new phone number.
2. Choose whether to create a new contact or save the number to an existing contact.

Clearing the Call History list

1. On the Call History tab, tap ⋮ > **Remove call history**.
2. Select the items you want to delete, or tap ⋮ > **Select all**.
3. Tap **Delete**.

Blocking a caller

When you block a phone number or a contact, all calls from the phone number or contact will be declined automatically.

On the Call History tab, press and hold the contact or phone number you want to block, and then tap **Block contact**.



You can always remove a caller from your blocked list. On the Call History tab, tap ⋮ > **Blocked contacts**. In the All tab, press and hold a contact, and then tap **Unblock contacts**.

Switching between silent, vibrate, and normal modes

Do one of the following:

- To change from silent to normal mode, press the VOLUME UP button twice.
- To change from vibrate to normal mode, press the VOLUME UP button.
- Go to Settings, and then tap **Sound & notification** > **Sound profile**.

Home dialing

When you're on a trip abroad, it's easy to dial friends and family from home.

Your home country code is automatically added when you call your contacts while roaming. But when manually entering a phone number to call, you need to enter a plus (+) sign and country code before the number.



Using a roaming service may incur additional charges. Check with your mobile operator for rates before using a roaming service.

Changing the default country code for Home dialing

1. From the Home screen, tap , and then tap **Settings > Call**.
2. Tap **Home dialing settings**.
3. Select a country, and then tap **OK**.





Turning off Home dialing

If you prefer to manually enter complete phone numbers to call while roaming, you can turn off Home dialing.

1. From the Home screen, tap , and then tap **Settings > Call**.
2. Clear the **Home dialing** option.

Messages

Sending a text message (SMS)

1. From the Home screen, tap , and then find and tap **Messages**.
2. Tap .
3. Enter a contact name or mobile number in the **To** field.
4. Tap the area that says **Add text**, and then enter your message.
5. Tap , or press  to save the message as a draft.









- There is a limit on the number of characters for a single text message (displayed above ). If you exceed the limit, your text message will be delivered as one but will be billed as more than one message.
- Your text message automatically becomes a multimedia message if you enter an email address as the recipient, attach an item, or compose a very long message.

Sending a multimedia message (MMS)



Before attaching and sending a high-resolution video, compress it first so that the file size doesn't exceed the message size limit.





1. From the Home screen, tap , and then find and tap **Messages**.
2. Tap .
3. Enter a contact name, mobile number, or email address in the **To** field.
4. Tap the area that says **Add text**, and then enter your message.
5. Tap , and then choose an attachment type.
6. Select or browse for the item to attach.
7. After adding an attachment, tap  to see options for replacing, viewing or removing your attachment.
8. Tap , or press  to save the message as a draft.

Sending a group message

Group messaging makes it easy to send a message to multiple contacts all at once. You can choose to send a group SMS or group MMS.



Group MMS may incur extra data fees.

1. From the Home screen, tap , and then find and tap **Messages**.
2. Tap .
3. Tap , and then select multiple recipients.
4. To send a group SMS, tap , and then select **Send as individual**. Clear this option to send your message as a group MMS.

Group SMS	Your message will be sent to the recipients as a text message and you will be charged by your mobile operator for each message sent. Replies of your recipients are sorted separately.
Group MMS	Similar to a group chat, sending a group MMS lets your recipients join the conversation you've started. HTC One X9 also organizes message replies in a single conversation thread. If this is your first time to send a group MMS, you may need to enter your mobile phone number.

5. Tap the area that says **Add text**, then enter your message.
6. Tap .

Resuming a draft message

If you switch to another app or if you receive an incoming call while composing a text message, the message is automatically saved as a draft.

1. From the Home screen, tap , and then find and tap **Messages**.
2. Tap a draft message, and then edit the message.



To see all draft messages in one place, tap , and then tap **Filter > Drafts**.

3. Tap .

Replying to a message



1. From the Home screen, tap , and then find and tap **Messages**.
2. Tap a contact (or phone number) to display the exchange of messages with that contact.

3. Tap the area that says **Add text**, and then enter your message.
4. Tap .

Replying to a contact's other phone number

When a contact has multiple phone numbers stored on HTC One X9, you can select which phone number to reply to.

Keep in mind that if you don't select another number, your response will be sent to the phone number that your contact used to send the last message.

1. While viewing the exchange of messages with a contact, tap  > **Recipient phone number** and select which phone number you want to reply to.
2. Tap the area that says **Add text**, then enter your reply message.
3. Tap .

Forwarding a message



1. From the Home screen, tap , and then find and tap **Messages**.
2. Tap a contact (or phone number) to view the exchange of messages with that contact.
3. Tap a message, and then tap **Forward**.

Moving messages to the secure box

You can move private messages to the secure box. You will need to enter a password to read these messages.



- The secure box does not encrypt messages.
- Messages stored on a nano SIM card cannot be moved to the secure box.

1. From the Home screen, tap , and then find and tap **Messages**.
2. Tap a contact (or phone number) to display the exchange of messages with that contact.
3. Tap  > **Move to secure box**.
4. Select the messages, and then tap **Move**.



To move all the messages from a contact, on the Messages screen, press and hold the contact and tap **Move to secure box**.

- To read messages in the secure box, on the Messages screen, tap  > **Secure**. If it is your first time to use the secure box, set a password.
- To remove messages or contacts from the secure box, press and hold the contact (or phone number) and tap **Move to general box**.

Blocking unwanted messages

Declutter your Messages screen by moving spam messages from contacts to the block box. If you have blocked a contact, that contact's text or picture messages will also be in the block box.

- Open the Messages app, press and hold a contact (or phone number) and tap **Block contact**.
- To block multiple contacts, tap **⋮** > **Block contacts**, select the contacts, and tap **Block**.

When the contact sends you messages, you will not see them in the Messages screen or receive notifications and calls.

To read messages in the block box, on the Messages screen, tap **▼** > **Block**.



- To remove messages or contacts from the block box, press and hold the contact (or phone number) and tap **Unblock**.
- To completely discard future messages from blocked contacts, tap **⋮** > **Settings** > **General**, and then clear the **Save block message** option.

Copying a text message to the nano SIM card

1. From the Home screen, tap **⋮**, and then find and tap **Messages**.
2. Tap a contact (or phone number) to display the exchange of messages with that contact.
3. Tap the message, and then select the card where you want to copy it. The **📄** icon is displayed.

Deleting messages and conversations

Open the Messages app and do any of the following:

Delete a message	<p>Open the conversation thread with a contact, tap the message, and then tap Delete message.</p> <p>To delete multiple messages within a conversation, tap ⋮ > Delete messages > Delete by selection, and then select the messages to delete.</p>
Delete a conversation	<p>Press and hold a contact (or phone number), and then tap Delete.</p> <p>To delete multiple conversations, tap ⋮ > Delete threads, and then select the conversations to delete.</p>



In the Messages settings, tap **General** > **Delete old messages** to auto delete old messages.

Preventing a message from being deleted

You can lock a message to prevent it from being deleted even if you delete the other messages in the conversation.

1. Open the Messages app.
2. Tap a contact (or phone number) to display the exchange of messages with that contact.
3. Tap the message that you want to lock.
4. Tap **Lock message** on the options menu. A lock icon  is displayed.

Power and storage management

Battery

Displaying the battery percentage

You can check the percentage of remaining battery power right from the status bar.

1. From the Home screen, tap  > **Settings** > **Power**.
2. Select **Show battery level**.

Checking battery usage

See how the system and apps are using the battery and how much power is being used.

1. From the Home screen, tap  > **Settings** > **Power**.
2. Tap **Battery usage**, and then tap an item to check how it's using the battery.
3. If you see the Adjust power use section while viewing battery use details, you can tap the option underneath it to adjust settings that affect battery usage.

Another way to check the battery usage per app is to go to **Settings** > **Apps**. Tap the app you want to check, and then tap **Battery**.



If the **Battery** option on the App info screen is grayed out, it means the app is currently not using the battery.

Checking battery history

Check how long you've been using HTC One X9 since the last charge. You can also see a chart that shows how long the screen has been on, and how long you've been using connections like the mobile network or Wi-Fi.

1. From the Home screen, tap  > **Settings** > **Power**.
2. Tap **History** to view battery usage over time.

Battery optimization for apps

When you have connections such as Wi-Fi on while the phone is in sleep mode, some apps may still continue to use the battery. Starting from Android 6.0, battery optimization is enabled for all apps by default which helps prolong battery standby time when you're not using the phone.

The phone needs to be sitting idle for an extended period of time before battery optimization takes effect.

Turning battery optimization off in apps

If there are apps that you don't want battery optimization enabled, you can turn the feature off in those apps.

1. From the Home screen, tap  > **Settings** > **Power**.
2. Tap **Battery optimization**.
3. Tap **Not optimized** > **All apps** to see the complete list of apps.
4. To turn off battery optimization in an app, tap the app name, and then tap **Don't optimize** > **Done**.

Repeat this process to turn off optimization in other apps.

To filter the list and see which apps have battery optimization disabled, tap **All apps** > **Not optimized**.

Using power saver mode

Power saver mode helps to increase battery life. It reduces the usage of phone features that drain the battery such as location services and mobile data.

1. From the Home screen, tap  > **Settings** > **Power**.
2. Tap the Power saver **On/Off** switch to turn power saver mode on or off.
To set when to automatically switch this mode on, tap **Power saver** > **Turn on automatically**, and then select a battery level.

Extreme power saving mode

In times when you don't need to use much of your phone, turn Extreme power saving mode on to extend battery life longer. In this mode, standby time can last longer than usual, and you can only use the most basic functions such as phone calls, text messaging, and email.

1. From the Home screen, tap  > **Settings** > **Power**.
2. Tap the Extreme power saving mode **On/Off** switch to turn extreme power saving mode on or off.
If you want to set when to automatically switch this mode on, tap **Extreme power saving mode** and select a battery level.

Tips for extending battery life

How long the battery can last before it needs recharging depends on how you use HTC One X9. Try out some of these tips to help increase battery life.

Use the power management features

- Turn **Power saver mode** and **Extreme power saver mode** on in Settings.
- Monitoring your battery usage helps identify what's using the most power so you can choose what to do about it. For details, see [Checking battery usage](#) on page 99.

Manage your connections

- Turn off wireless connections such as mobile data, Wi-Fi, or Bluetooth when not in use.
- Turn GPS on only when a precise location is needed, such as while using navigation or location-based apps. See [Turning location services on or off](#) on page 158.
- Turn on Airplane mode when you don't need any wireless connections and you don't want to receive calls or messages.

Manage your display

Lowering the brightness, letting the display sleep when not in use, and keeping it simple helps save battery power.

- Use automatic brightness (the default), or manually lower the brightness.
- Set the screen timeout to a shorter time.
- Don't use a live wallpaper for your Home screen. Animation effects are nice to show off to other people but they drain your battery.

Changing your wallpaper to a plain, black background can also help a little. The less color is displayed, the less battery is used.

For more details, see [Settings and security](#) on page 158 and [Personalizing](#) on page 49.

Manage your apps

- Battery optimization helps extend battery standby time. See [Battery optimization for apps](#) on page 99.
- Install the latest software and application updates. Updates sometimes include battery performance improvements.
- Uninstall or disable apps that you never use.

Many apps run processes or sync data in the background even when you're not using them. If there are apps that you don't need anymore, uninstall them.



If an app came preloaded and can't be uninstalled, disabling the app can still prevent it from continuously running or syncing data. See [Disabling an app](#) on page 163.

Limit background data and sync

Background data and sync can use a lot of battery power if you have many apps syncing data in the background. It's recommended not to let apps sync data too often. Determine which apps can be set with longer sync times, or sync manually.

- In Settings, tap **Accounts & sync** and check what types of data are being synced in your online accounts. When the battery is starting to run low, temporarily disable syncing some data.
- If you have many email accounts, consider prolonging the sync time of some accounts.

In the Mail app, select an account, tap  > **Settings** > **Sync, Send & Receive**, and then adjust the settings under Sync schedule.

- When you're not traveling from one place to another, sync weather updates of only your current location, rather than in all of your named cities. Open the Weather app, and then tap  to edit and remove unneeded cities.
- Choose widgets wisely.
Some widgets constantly sync data. Consider removing the ones that are not important from your Home screen.
- In Play Store, tap  > **Settings**, and then clear **Add icon to Home screen** to avoid automatically adding Home screen app shortcuts whenever you've installed new apps. Also tap **Auto-update apps** > **Do not auto-update apps** if you're fine with updating apps from Play Store manually.

Other tips

To squeeze in a little bit more battery power, try these tips:

- Tone down the ringtone and media volume.
- Minimize the use of vibration or sound feedback. In Settings, tap **Sound & notification** and choose which ones you don't need and can disable.
- Check your apps' settings as you may find more options to optimize the battery.

Storage

Types of storage

Starting from Android 6.0, there have been some changes on how and where downloaded apps and their data can be stored.

Phone storage

This is the internal storage which contains the Android system, preinstalled apps, email, text messages, and cached data from the apps. You can also install apps that you've downloaded and capture photos, videos, and screenshots to this storage.

Storage card

Use your storage card as a removable storage to store and access your media and other files on HTC One X9 or any Android phone, or set it up as an extension of the internal storage. See [Should I use the storage card as removable or internal storage?](#) on page 103.

USB storage

You can plug in an external USB storage device such as a USB flash drive or an SD card reader. You need a special cable to connect HTC One X9 and a USB storage device.

Should I use the storage card as removable or internal storage?

Use your storage card as removable storage when there's already content such as your media and other files so that you don't lose these content. If you have a brand new storage card, choose whether to use it as removable storage or set it up as an extension of the internal storage.

Removable storage

Use a new storage card as removable storage to be able to insert and use the card on HTC One X9 and other Android phones.

Internal storage

Set up a new storage card as internal storage for more privacy and secure use. This encrypts and formats the storage card to work just like the internal storage.

This also expands the internal storage space since:

- Captured screenshots, camera shots, media, and other files will be stored on the storage card.
- Third-party apps that you installed and their data can be moved between the phone storage and storage card.



After setting up the storage card as internal storage, the card can only be used on HTC One X9 where it has been formatted.

Setting up your storage card as internal storage

When you insert a storage card that has not been used on HTC One X9 before, the card will be mounted as removable storage by default.

If the storage card is new or doesn't have content you want to keep, you can format the storage card to use it as internal storage for HTC One X9.



- See [Should I use the storage card as removable or internal storage?](#) on page 103 to find out the differences between using the storage card as removable storage or internal storage.
- If there are still files on the storage card, back up the files first before you format the card.

1. From the Home screen, tap **⋮** > **Settings** > **Storage & USB**.
2. Under Removable storage, tap the storage card name.
3. Tap **⋮** > **Settings**.
4. Tap **Format as internal**.
5. Tap **Erase & format**.

6. Tap **Format**.
7. Follow the onscreen instructions to move your installed apps and their data from the phone storage to the storage card.





If you no longer want to use your storage card as internal storage, you can reformat the card as removable storage. Before you do so, make sure to move all the apps and data from the card back to the phone storage. See [Moving apps and data between the phone storage and storage card](#) on page 104.

Moving apps and data between the phone storage and storage card

If you've set up your storage card as internal storage, you can move third-party apps that you installed and their data such as photos, media, and downloaded files to the storage card to free up phone storage space.

If you no longer want to use your storage card as internal storage, make sure to move all the apps and data from the card back to the phone storage.

1. From the Home screen, tap  > **Settings** > **Storage & USB**.
2. Tap the name of your storage card if you're moving app data from the phone storage to the card, or tap **Phone storage** if you're moving data from the storage card back to the phone storage.
3. Tap  > **Migrate data**.
4. Tap **Move**.



- Screenshots will also be migrated.
- When you take new photos or videos, capture new screenshots, or download new files after the migration, they will be saved to the new storage location.

Moving an app to the storage card

When you're running out of phone storage space, you can move your downloaded apps to the storage card if the card has been set up as internal storage.



Preinstalled apps cannot be moved.

1. From the Home screen, tap  > **Settings** > **Storage & USB**.
2. Tap **Phone storage** > **Apps**.
3. Tap the app you want to move.





4. Tap **Change**, and then tap the storage card name.
5. Tap **Move**.



You can also move an app from the storage card back to the phone storage.

Viewing and managing files on the storage

Starting from Android 6.0, you can go to Settings to view and manage files on the phone storage and storage card. You can also view and manage files on an external USB storage device when you have it connected to HTC One X9.

1. From the Home screen, tap  > **Settings** > **Storage & USB**.
2. Tap **Phone storage** or the storage card name.
3. Tap **Explore** to view internal storage content—whether it's phone storage content or internal storage content on the storage card.
4. To select or deselect files:
 - Press and hold a file to select it. To select more files, tap each file.
 - Tap a file to deselect it.
 - To select all files, press and hold a file first, and then tap  > **Select all**.
5. Do one of the following:
 - To delete, tap .
 - To paste, tap  > **Copy to**. In the Save to slideout menu, choose where to paste to, and then tap **Copy**.

Copying files between HTC One X9 and your computer

You can copy your music, photos, and other files to HTC One X9.



- Save and close your files before copying them from your computer to HTC One X9, or vice versa.
- If you're using your storage card as internal storage, your computer will only show storage card content.

1. Connect HTC One X9 to the computer using the supplied USB cable.
2. On HTC One X9, unlock the screen if it's locked.
3. On the pop-up message that asks whether to use USB for file transfers, tap **Yes**.

If you don't see this message, slide the Notifications panel open, tap the **Use USB for** notification, and then tap **File transfers**.

You'll then see options for viewing or importing files on the computer screen.

4. Choose to view files.

5. Copy the files from your computer to HTC One X9, or vice versa.
6. After copying the files, disconnect HTC One X9 from the computer.

Freeing up storage space

As you use HTC One X9, you'll accumulate data and fill its storage capacity over time. Here are some tips on how to free up phone storage space.

Manage photos and videos

- After taking continuous camera shots, keep only the best shot. Discard the rest, if you don't need them.
- After editing a photo or trimming a video, the original file is kept. Delete original files or move them elsewhere, such as to your computer.
- If you're only sending videos through MMS, use a lower resolution. Hi-res video takes up more space. In Camera settings, tap **Video Quality** to change the resolution.

Remove unused themes

Themes can quickly consume up storage space because themes can include images, sounds and icons. Remove themes you're not using. See [Deleting a theme](#) on page 51.

Back up data and files

Keep only the most recent data in your apps and files that you often need to use. You can back up your other data and files. For some tips, see [Ways of backing up files, data, and settings](#) on page 110.

Remove or disable apps

Uninstall apps that you've downloaded if no longer need them. Preinstalled apps can be disabled when you're not using them. See [Disabling an app](#) on page 163.

Move apps to the storage card

Third-party apps that you've downloaded and installed can be moved to the storage card if you've set up the card as internal storage. See [Moving apps and data between the phone storage and storage card](#) on page 104 and [Moving an app to the storage card](#) on page 104.

Unmounting the storage card

When you need to remove the storage card while HTC One X9 is on, unmount the storage card first to prevent corrupting or damaging the files in the storage card.



If your storage card is used as internal storage and there are apps that were moved to the card, you will not be able to open these apps after unmounting the card.

1. From the Home screen, tap > **Settings** > **Storage & USB**.
2. Do one of the following:
 - If your storage card appears under Removable storage, tap > **Eject** next to the card name.
 - If your storage card appears under Internal storage, tap the card name, and then tap > **Eject**.

File Manager

About File Manager

Use the File Manager app to browse and organize your files and folders on your phone storage and storage card.

Switching between storage types

1. From the Home screen, tap , and then find and tap **File Manager**.
2. Swipe left or right to switch to a file storage where you want to browse or organize your files.

Searching for files

1. In File Manager, tap .
2. In the search box, enter a few characters of the filename, and then tap the Enter key . Matching filenames from the root and subfolders are then displayed.
3. Tap a file to open it.

Sorting your files

1. In File Manager, tap > **Sort**.
2. Choose how you want to sort your files and folders.

Copying or moving files

1. In File Manager, browse for the file or folder.
2. Select items to copy or move.
3. Tap **Copy** or **Move to**.

4. Press **<**, and then browse for the folder where you want to copy or move the files.
Or tap **⋮** > **Create folder** to create a new folder.
5. Tap **Paste**.

Favoriting files

1. In File Manager, browse for the file or folder.
2. Select items to favorite.
3. Tap **♥**.

To remove an item from the Favorites tab, select the item and tap **Remove from favorites**.

Deleting files or folders



1. In File Manager, browse for the file or folder.
2. Select items to delete.
3. Tap **Delete**.

Sync, backup, and reset

Online sync

Adding your social networks, email accounts, and more



You can sync contacts, calendars, and other information from your social networks, email accounts, and online services on HTC One X9. Depending on the account type, signing in to your online accounts lets you sync updates between HTC One X9 and the Web.

1. From the Home screen, tap  > **Settings** > **Accounts & sync**.
2. Tap .
3. Tap the account type you want to add.
4. Follow the onscreen instructions to enter your account information.



- In **Settings** > **Accounts & sync**, tap the **Auto sync On/Off** switch to turn automatic sync of all your accounts.
- You can add several Google Accounts.

Syncing your accounts

1. From the Home screen, tap  > **Settings** > **Accounts & sync**.
2. Tap the **Auto sync On/Off** switch to turn automatic sync of all your accounts on or off.
3. To manually sync individual accounts, tap an account type, and then do one of the following:
 - Tap  next to the account you want to sync, and then tap **Sync now**.
 - Tap  > **Sync now** on the Account settings screen.



On the Account settings screen, you can also change the sync settings for an account.

Removing an account

Remove accounts from HTC One X9 if you no longer use them. Removing an account does not remove accounts and information from the online service itself.

1. From the Home screen, tap  > **Settings** > **Accounts & sync**.
2. Tap an account type.

3. Tap **⋮** next to the account you want to remove.
Or if you're on the Account settings screen, tap **⋮**.
4. Tap **Remove**.



Some personal data may be retained by the third-party app after you have removed the account from HTC One X9.

Backup

Ways of backing up files, data, and settings

Worried that you might lose important stuff on HTC One X9? Back up HTC One X9 before you remove content from the storage, do a factory reset, or upgrade to a new phone.

Android Backup Service

Use your Google Account to automatically back up app data and settings including Wi-Fi passwords and files stored by certain apps.

HTC Sync Manager

Use HTC Sync Manager to import music, photos, and videos from HTC One X9 to your computer. You can also sync locally stored contacts, calendar events, and playlists between HTC One X9 and your computer.

Likewise, HTC Sync Manager is a good alternative if you don't want to back up your accounts, settings, and other personal content to the cloud. You can use it to create backups of HTC One X9 on your computer.

Other backup options

If you want, you can separately back up your data or files.

Some apps allow you to back up data to the phone storage or storage card so you can easily restore them after a factory reset. Just make sure not to erase the phone storage or storage card when you do a factory reset.

Messages	Back up your text messages to the phone storage or storage card, or save them as an email attachment.
Contacts	<ul style="list-style-type: none"> ▪ Save contacts and other personal data to your online accounts so you can just sync them when switching to another phone. ▪ If you have locally stored contacts in the People app, export them to the phone storage or storage card.
Files	Manually copy and paste files by connecting HTC One X9 to your computer as a disk drive.
Other data	Check other apps to see if they support exporting data to the phone storage or storage card.

Using Android Backup Service

Starting from Android 6.0, use the Android Backup Service to back up your HTC phone to Google Drive™.

This service can back up and restore the following:



Personalized HTC Sense Home	These include widgets, wallpaper, Home screen layout, ringtones, and grid size and sort order on the Apps screen.
App data	<ul style="list-style-type: none"> ▪ In HTC apps, app data includes contacts stored on HTC One X9, text messages, call history, Clock and Weather city list, and email accounts. ▪ Data from third-party apps may also be saved in the backup, depending on the app developer settings.
Settings	These include Wi-Fi networks and passwords and some device settings.

When auto backup is enabled, the Android Backup Service periodically backs up your phone to a private folder in Google Drive. Auto backup occurs every 24 hours when the phone is idle, charging, and connected to a Wi-Fi network.

Backup data will not count towards your Google Drive storage quota. Large files or files that app developers have chosen to exclude from the service will not be backed up.

Backing up HTC One X9

Automatically back up HTC One X9 to Google Drive so you can restore content such as app data and settings when needed.

1. From the Home screen, tap  > **Settings** > **Backup & reset**.
2. Tap **Back up my data**.
3. Tap the **On/Off** switch to turn it on, and then tap .
4. Make sure **Automatic restore** is turned on.

This allows an app's data and settings saved through the Android Backup Service to be restored when you reinstall the app on HTC One X9.





To select a backup account other than your primary Google Account, tap **Backup account** and then select another Google Account. You can also tap **Add account** to add a new Google Account for your backup.

Backing up your data locally

If you want to separately back up your content such as contacts and text messages on HTC One X9, here are some tips on how to export or import your data.

Backing up your contacts

1. From the Home screen, tap , and then find and tap **People**.
2. On the People tab, tap  > **Manage contacts**.
3. Tap **Import/Export contacts** > **Export to phone storage** or **Export to SD card**.

4. Select an account or type of contacts to export.
5. To help protect your data, tap **Yes**, and then set a password for this backup. Be sure to remember this password. You'll need to enter it again when importing contacts.
If you don't need a password, tap **No**.
6. Tap **OK**.

Restoring contacts



1. On the People tab, tap  > **Manage contacts**.
2. Tap **Import/Export contacts** > **Import from phone storage** or **Import from SD card**.
3. If you have more than one account set up, tap the type for the imported contacts.
4. If you have multiple backups available, select the backup you want to import, and then tap **OK**.
5. Enter the password you've set for this backup, and then tap **OK**.

Backing up your text messages

Keep important text messages by backing them up so you can restore them to the HTC Messages app, if needed. The Messages app backs up either to the phone storage or to your storage card if you have one inserted.





Text messages in the secure box and blocked messages will not be backed up. To include such messages to your backup, move them first to the general message box.

1. From the Home screen, tap , and then find and tap **Messages**.
2. Tap  > **Back up/Restore SMS** > **Back up** > **Back up SMS**.
3. To help protect your data, set a password for your backup. Be sure to remember this password. You'll need to enter it again when restoring messages.
If you don't need a password, select **Do not password protect this backup**.
4. Enter a name for your backup file, and then tap **OK**.

Backing up text messages by email



- You need to set up your email account in the HTC Mail app.
- Text messages in the secure box and blocked messages will not be backed up. To include such messages to your backup, move them first to the general message box.



1. From the Home screen, tap , and then find and tap **Messages**.
2. Tap  > **Back up/Restore SMS**.
3. Tap **Back up** > **Back up SMS via mail**.

4. To help protect your data, set a password for your backup. Be sure to remember this password. You'll need to enter it again when restoring messages.

If you don't need a password, select **Do not password protect this backup**.

5. Enter your email address.
6. Compose your email message, and then send it.

Restoring text messages

1. From the Home screen, tap , and then find and tap **Messages**.
2. Tap  > **Back up/Restore SMS** > **Restore**.
3. Choose how you want to restore the messages, and tap **Next**.
4. Tap the backup to import.
5. Enter the password you've set for this backup. If you didn't set a password, select **This backup file is not password protected**.
6. Tap **OK**.

To restore text messages that were backed up via email, open the email message with the backup file attachment from the Mail app. Tap the attachment to download it first, and then tap it again to open the backup file to import. Enter the password you've set for this backup or select **This backup file is not password protected**.

HTC Sync Manager

About HTC Sync Manager

HTC Sync Manager supports a computer running a Windows or OS X operating system.

Here's what you can do with HTC Sync Manager.

View and manage media on your computer and phone

- Browse and manage music, photos, and videos that are on your computer and your phone.
- Import iTunes and Windows Media® Player playlists from your computer to HTC Sync Manager.
- Create playlists from music on your phone or your computer and then sync these playlists to both devices.
- Play music and videos using the built-in player.

Transfer content

- Transfer iPhone photos, text messages, contacts, and more to your HTC phone. You can also find and install the same apps that you were using on your iPhone.
- Import all music, photos, and videos from your HTC phone to your computer.

- Copy selected music, photos, or videos from your computer to your phone.
- Import documents from your computer to your phone.

Back up and restore

Back up your HTC phone to your computer so you can easily restore your backup to the same phone or to another HTC phone.

Sync data

Sync data such as contacts and calendar between your phone and your computer.

Installing HTC Sync Manager on your computer



- You can install HTC Sync Manager on Windows XP or later versions. To install it on a Mac computer, you need OS X 10.6 or later versions.
- If you have problem in installing HTC Sync Manager, close all your running programs and reinstall. If the problem persists, temporarily disable your anti-virus program and try installing again.

1. Download the HTC Sync Manager installer from the HTC support site: htc.com/hsm/.
2. Launch the installer and follow the onscreen instructions.
3. Connect your phone to your computer using the supplied USB cable. HTC Sync Manager opens.



If you disabled your anti-virus program, make sure to turn it back on after installing HTC Sync Manager.

Transferring iPhone content and apps to your HTC phone

With HTC Sync Manager, easily transfer iPhone content such as contacts, messages, wallpaper, camera photos, and more to your HTC phone. If you're using an HTC phone that has HTC Sense 6, HTC Sync Manager also enables your phone to find and install the same apps that you were using on your iPhone.



You need to use iTunes 9.0 or later to back up your iPhone content first to your computer.

1. Connect your iPhone and your HTC phone to your computer.
2. In HTC Sync Manager, click **Home > Transfer & Backup**.
3. Click the **Get Started** button.
4. If you haven't used iTunes to back up your iPhone content to your computer, please do so before proceeding.
5. Select your iPhone backup file, and then click **OK**.

6. Select the types of content you want to transfer to your HTC phone.

You can choose whether to replace the content on your HTC phone with the iPhone content.

7. Click **Start**. Wait for HTC Sync Manager to finish transferring content.
8. When done, slide the Notifications panel open on your HTC phone, and then tap .

Choose which apps you were using on iPhone you want to find in Google Play and download to your HTC phone.

Getting help

To find out more about using HTC Sync Manager, download the user guide PDF from the HTC support site (htc.com/hsm/). Or open the Help that comes with the software.



On Windows, click  in HTC Sync Manager, and then click **Help**.

Reset

Restarting HTC One X9 (Soft reset)

If HTC One X9 is running slower than normal, is unresponsive, or has an app that is not performing properly, try rebooting and see if that helps solve the problem.

1. If the display is off, press the POWER button to turn it back on.
2. Press and hold the POWER button, and then tap **Restart**.
3. When asked to confirm, tap **Restart**.

HTC One X9 not responding?

If HTC One X9 does not respond when you touch the screen or press the buttons, you can still restart it.

Press and hold the POWER and VOLUME UP buttons for at least 12 seconds. HTC One X9 then restarts.

Resetting network settings

Reset the network settings when you're having problems connecting HTC One X9 to your mobile data or Wi-Fi network and Bluetooth devices.

1. From the Home screen, tap  > **Settings** > **Backup & reset**.
2. Tap **Network settings reset**.

3. Tap **Reset settings**.
4. Tap **Reset settings**.

Resetting HTC One X9 (Hard reset)

If HTC One X9 has a persistent problem that cannot be solved, you can perform a factory reset (also called a hard reset or master reset). A factory reset reverts the phone back to its initial state—the state before you turned on the phone for the first time.



Factory reset will remove all data on your phone storage, including apps you've downloaded and installed, your accounts, your files, as well as system and app data and settings. Be sure to back up any data and files you want to keep before you do a factory reset.

1. From the Home screen, tap  > **Settings** > **Backup & reset**.
2. Tap **Reset phone**.
To also delete media and other data from your storage card, select **Erase SD card**.
3. Tap **OK**.



A factory reset may not permanently erase all data from your phone, including personal information.

People

Your contacts list

The People app lists all contacts you've stored on HTC One X9 and from online accounts you're logged in to. Use the People app to easily manage communications with people that matter to you.

1. From the Home screen, tap , and then find and tap **People**.

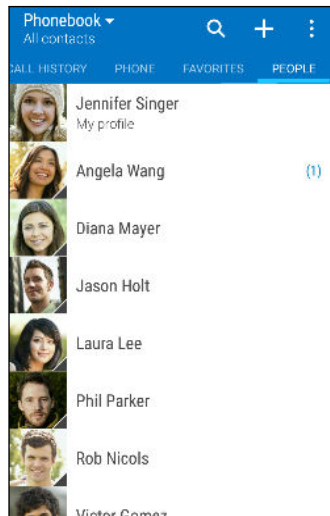

2. On your contacts list, you can:
 - View your profile and edit your contact information.
 - Create, edit, find, or send contacts.
 - Tap a contact photo to find ways to quickly connect with the contact.
 - See when a contact has sent you new messages.



To sort your contacts by their first or last name, tap  > **Settings** > **Sort contacts by**.



Filtering your contacts list

When your contacts list gets long, you can choose which contact accounts to show.

1. On the People tab, tap .
2. Choose the accounts that contain the contacts you want to display.
3. Press .

Finding people

Search for contacts stored on HTC One X9, your company directory if you have an Exchange ActiveSync account, or social networks you've signed into.



1. From the Home screen, tap , and then find and tap **People**.
2. On the People tab, you can:
 - Find people in your contacts list. Tap , and then enter the first few letters of the contact name in the Search people box.
 - Find people on your company directory. Tap , enter the first few letters of the contact name in the Search people box, and then tap **Search contacts in your Company Directory**.



Aside from searching for a contact by name, you can search using a contact's email address or company name. On the People tab, tap  > **Settings** > **Search contacts by**, and then choose a search criteria.





Setting up your profile

Store your personal contact information to easily send it to other people.

1. From the Home screen, tap , and then find and tap **People**.
2. Tap **My profile**.
3. Tap **Edit my contact card**.
4. Enter or edit your name and contact details.
5. Tap  or the current photo to change your contact photo.
6. Tap .

Aside from your contact details, swipe to the Updates tab to see updates you've posted on your social networks.

Adding a new contact

1. From the Home screen, tap , and then find and tap **People**.
2. On the People tab, tap .
3. Tap the **Name** field, and then enter the contact name. Tap  to separately enter the contact's given, middle, or family name and name suffix, such as Jr.
4. Select the Contact type. This determines which account the contact will sync with.
5. Enter the contact information in the fields provided.
6. Tap .

When you tap the added contact in your contacts list, you'll see the contact information and your exchange of messages and calls. Depending on the contact type, you may also see the person's social network updates or events.

How do I add an extension number to a contact number?



While creating a new contact or editing a contact's details in People, you can add an extension number to their number so you can skip the voice prompts when calling.

1. After entering the number of the main line, do one of the following:
 - Tap **P(,)** to insert a pause before the phone dials the extension number. To insert a longer pause, enter **P(,)** several times.
 - Tap **W(,)** to be prompted to confirm the extension number.
2. Enter the extension number.

Editing a contact's information



Social network contacts cannot be edited.

1. From the Home screen, tap , and then find and tap **People**.
2. On the People tab, press and hold the contact, and then tap **Edit contact**.
3. Enter the new information.
4. Tap .

Getting in touch with a contact

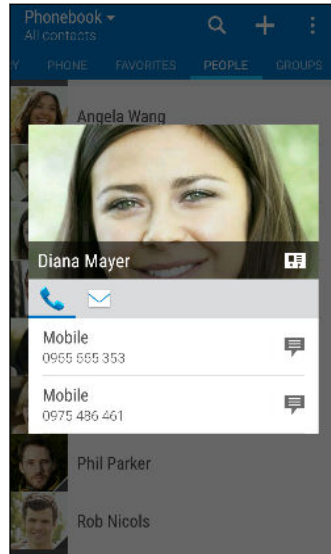

1. From the Home screen, tap , and then find and tap **People**.
2. Tap a contact's photo (not the name), and then choose how you want to get in touch with that contact.





For more ways of getting in touch with your contact, tap an icon below the contact photo.

Importing or copying contacts

Importing contacts from your nano SIM card

1. From the Home screen, tap , and then find and tap **People**.
2. On the People tab, tap  > **Manage contacts**.
3. Tap **Import/Export contacts** and then choose which card to import from.
4. If prompted, select which account you'd like to import your contacts to.
5. Select the contacts you want to import.
6. Tap **Save**.

Importing a contact from an Exchange ActiveSync account

1. On the People tab, tap  and enter the contact's name or email address in the search box.
2. Tap **Search contacts in your Company Directory**.
3. Tap the name of the contact you want copied to HTC One X9.
4. Tap  to import the contact.

Copying contacts from one account to another



Contacts from social networks may not be able to be copied.

1. On the People tab, tap > **Manage contacts**.
2. Tap **Copy contacts**, and then choose a contact type or online account to copy from.
3. Select a contact type or account you want to save to.

Merging contact information

Avoid duplicate entries by merging contact information from different sources, such as your social network accounts, into one contact.

Accepting contact link suggestions

When HTC One X9 finds contacts that can be merged, you'll see a link notification when you open the People app.

1. From the Home screen, tap , and then find and tap **People**.
2. On the People tab, tap the Contact link suggestion notification when available. You'll see a list of suggested contacts to merge.
3. Tap next to the contact you want to merge. Otherwise, tap to dismiss the link suggestion.



If you don't want to receive contact link suggestions, on the People tab, tap > **Settings**. Clear the **Suggest contact link** option.

Manually merging contact information

1. On the People tab, tap the name of the contact (not the icon or photo) you want to link.
2. Tap > **Link**.
3. You can:
 - Under **Suggest links**, link the contact to an account.
 - Under **Add contact**, tap one of the options to link to another contact.

Breaking the link

1. On the People tab, tap the name of the contact (not the icon or photo) whose link you want to break.
2. Tap > **Link**.
3. Under the **Linked contacts** section, tap beside an account to break the link.

Sending contact information

1. From the Home screen, tap , and then find and tap **People**.
2. On the People tab, do one of the following:

To send	Do this
Someone's contact information	Press and hold the name of the contact (not the icon or photo), and then tap Send contact as vCard .
Your contact information	Press and hold My profile , and then tap Send my profile .

3. Choose how you want to send the vCard.
4. Select the type of information you want to send.
5. Tap **Send**.

Sending multiple contact cards



1. On the People tab, tap  > **Send contacts**.
2. Select the contacts whose contact information you want to share
3. Tap **Send**.
4. Choose how you want to send the contact cards.

Contact groups

Organize your friends, family, and colleagues into groups so you can quickly send a message or email to everyone in the group. We've also set up the Frequent group to automatically add the contacts you dial or get calls from the most.

HTC One X9 also syncs with groups you've created in your Google Account.

Creating a group

1. From the Home screen, tap , and then find and tap **People**.
2. On the Groups tab, tap .
3. Enter a name for the group, and then tap  > **Add contact to group**.
4. Select the contacts you want to add, and then tap **Save**.
5. When your group is complete, tap **Save**.

Sending a message or email to a group



You will be charged for each text message sent. For example, if you send a message to a group of five people, you will be charged for five messages.

1. On the Groups tab, tap the group you want to send a message or email to.
2. Go to the Group action tab.
3. Choose if you want to send a group message or group email.

Editing a group

1. On the Groups tab, press and hold the group, and then tap **Edit group**.
2. You can:
 - Change the group name. You can only change the name for groups that you have created.
 - Add more contacts to the group. Tap **⋮** > **Add contact to group**.
 - Select the contacts you want to remove from the group.
3. Tap **Save**.

Removing contact groups

1. On the Groups tab, tap **⋮** > **Edit groups**.
2. Select the contact groups you want to remove.
3. Tap **Save**.

Private contacts

If you don't want to show a contact's name and photo on the lock screen when you have an incoming call, add the contact to your private contacts list.

Adding a contact to the private contacts list





Contacts must have a phone number before they can be added to the private contacts list.

1. From the Home screen, tap **⋮**, and then find and tap **People**.
2. On the People tab, press and hold the contact, and then tap **Add to private contacts**.

To view your private contacts list, on the People tab, tap **⋮** > **Manage contacts** > **Private contacts**.

Organizing your private contacts



1. On the People tab, tap  > **Manage contacts** > **Private contacts**.
2. To add contacts to the private contacts list, tap , select the contacts you want to add, and then tap **Save**.
3. To remove private contacts from the list, tap  > **Remove private contact**, select the contacts you want to remove, and then tap **Remove**.

Calendar and Email

Calendar

Viewing the Calendar

Use the Calendar app to view your events, meetings, and appointments. If you've signed into your online accounts, related events will also appear in Calendar.

1. From the Home screen, tap , and then find and tap **Calendar**.
2. Tap , and then choose a calendar view.



If you see the current date  icon, tap it to return to the current date.

Month view

In month view, you will see markers on days that have events. Upcoming events for the day are also shown at the bottom of the screen.

- Swipe left or right across the screen to view succeeding or previous months.
- Tap a day to view the events for that day.
- Press and hold a day to see more options.

Day and agenda views

Day view shows your day's schedule and weather forecast for the next few days, while agenda view gives a quick glance of all your day's events.

- Swipe left or right across the screen to view succeeding or previous days.
- Tap an event to view its details.
- If the event is a contact's birthday or anniversary, tap it to send a greeting.



Need to see the event time in another time zone? In Day view, tap  > **Select 2nd time zone** > **Choose location**, and then enter the city name.

Week view

Week view displays a chart of the events of one week.

- Swipe left or right across the screen to view succeeding or previous weeks.
- Tap an event (shown as colored blocks) to view its details.

- Check the week number in the upper left corner of the chart.
- Select the day you start a week by tapping **⋮** > **Settings** > **First day of week**.

Scheduling or editing an event

You can create or edit events on HTC One X9, and also sync events with your Exchange ActiveSync calendar. You can also create, modify, and sync events with your Google calendar.



Editing events is not supported for all accounts.

1. From the Home screen, tap **⋮**, and then find and tap **Calendar**.
2. On any Calendar view, do one of the following:

Create an event Tap **+**. Tap **▼**, and then select the calendar you will add the event to.

Edit an event View an event, and then tap **✎**.

3. Enter and set the event details. Aside from setting the event name, date, time, and location, you can:

Invite contacts from your Exchange ActiveSync or Google account Tap **👤**, and select the contacts you want to invite.

Set the event to repeat Tap the **Does not repeat** button, and then select a repeat schedule. You can then set the repeat frequency and end date.

Create an event note While viewing the event details, tap **Create note**.

4. Tap **Save**.

If you've invited people to the event, tap **Send** or **Send update**.

Checking your schedule for an event

Avoid juggling multiple meetings at the same time. In Calendar, you can check your appointments to see if a new event would conflict with your schedule.

1. When creating or editing an event, tap **Check calendar**.
2. Press and hold the event box, and then drag it to an available time slot.
3. Drag the top and bottom nodes to adjust the event's time duration. You'll see a message if there are conflicts with other scheduled events.
4. Tap **Done** to return to the event screen, and then save your event.

Choosing which calendars to show

1. From the Home screen, tap **⋮**, and then find and tap **Calendar**.
2. Tap **⋮** > **Accounts (All calendars)** or **Accounts (Multi-calendar)**.

3. Select or clear an account you wish to show or hide.

If you have multiple calendars under an online account, tap **•••** to select the items to include.

4. Tap **Save**.



Calendars are synced on HTC One X9, even if they are hidden.

Sharing an event

You can share a calendar event as a vCalendar using Bluetooth or by sending it as a file attachment with your email or message.

1. From the Home screen, tap **⋮**, and then find and tap **Calendar**.
2. Do one of the following:
 - While viewing an event, tap **⋮** > **Share via**.
 - In day, agenda or week view, press and hold an event and then tap **Share via**.
3. Choose how you want to send the event.



You can also forward accepted meeting invitations from your Exchange ActiveSync calendar. While viewing an event, tap **⋮** > **Forward**. Compose your email message, and then send it.

Accepting or declining a meeting invitation

Switch to Invites view to see meeting invitations which you have not yet accepted or declined.



You must set up an Exchange ActiveSync account to receive meeting invitations in Calendar.

1. From the Home screen, tap **⋮**, and then find and tap **Calendar**.
2. Tap **▼** > **Invites**, and then tap a meeting invitation.
3. Accept, decline, or tentatively accept the invitation, or propose a new time.



Tap **⋮** to choose from more options, such as moving the invitation to a folder.

If you need to cancel an accepted meeting invitation or propose a new time, view the event details in Calendar, and then tap **Response**.

Dismissing or snoozing event reminders

If you have set at least one reminder for an event, the upcoming event icon  will appear in the notifications area of the status bar to remind you.

1. Slide the Notifications panel open.
2. If the notification shows that there are multiple reminders, tap it to see all the reminders. You can then choose to snooze or dismiss them.
3. If you see a single event notification, spread your two fingers on the notification to expand it. You can then:
 - Tap **Snooze** or **Dismiss**. Or drag the notification left or right to dismiss it.
 - Tap **Send mail** to send a quick response to the meeting attendees.





To edit the preset quick responses or add your own, open Calendar, and then tap **⋮ > Settings > Quick response**.

If you don't want to dismiss or snooze the calendar reminders, press **<** from the Notifications panel to keep them pending in the notifications area of the status bar.

Mail

Checking your mail

The Mail app is where you read, send, and organize email messages from one or more email accounts that you've set up on HTC One X9.

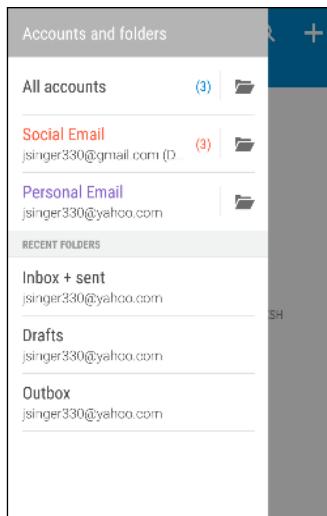

1. From the Home screen, tap , and then find and tap **Mail**. The inbox of one of your email accounts appears.
2. Do any of the following:
 - Tap an email message to read.
 - To display email messages in another mail folder, tap  > **Folder**, and then tap the folder you want to view.
 - To switch between email accounts or view email messages from all your accounts, tap .





- To change an email account's settings, select the account first and then tap  > **Settings**.

Organizing your inbox

Do you have a big pile of email messages in your inbox? Organize your email messages into tabs and quickly find the messages you want.



1. Switch to the email account that you want to use.
2. In the inbox, tap  > **Edit tabs**.
3. Select the tabs you want to add to the inbox.
4. To arrange the tabs, drag , and then move the tab to its new location.
5. Tap **Done**.
6. Swipe to the added tab to check your email messages.

Sending an email message



1. From the Home screen, tap , and then find and tap **Mail**.
2. Switch to the email account that you want to use.
3. Tap .
4. Fill in one or more recipients.





Want to loop in more recipients in a carbon copy (Cc) or blind carbon copy (Bcc) of the email message? Tap  > **Show Cc/Bcc**.

5. Enter the subject, and then compose your message.
6. Do any of the following:
 - Add an attachment. Tap  and then choose what you want to attach.
 - Set the priority for an important message. Tap  > **Set priority**.
7. Tap .



To save the email as draft and send it later, tap  > **Save**. Or press .

Resuming a draft email message

1. In an email account inbox, tap  > **Folder > Drafts**.
2. Tap the message.
3. When you finish editing the message, tap .

Reading and replying to an email message

1. From the Home screen, tap , and then find and tap **Mail**.
2. Switch to the email account you want to use.
3. In the email account inbox, tap the email message or conversation you want to read.



If you want to read a particular message inside an email conversation, tap  to expand the conversation, and then tap the email message.

4. Tap **Reply** or **Reply All**.



Tap  for more actions for the email.

Quickly replying to an email message

You can quickly respond to a new email message from the Home screen or lock screen.

1. When you receive a new email message notification, slide the Notifications panel down.
2. On the email preview, tap **Reply all**.

If you have several notifications and you don't see the email options, expand the email preview by sliding two fingers apart on the notification.

3. Compose your reply message and tap .

Saving an image in an email message



- Depending on your mail size limit settings, you may need to tap **Display images** to see images that are embedded in an email.
- Inline images may not display correctly when using certain mail accounts.

While viewing an email message, press and hold an embedded image, and then tap **Save image**. You'll find the saved image in the **All downloads** album in Gallery.

You can also copy the image to the clipboard or set it as your wallpaper.

Managing email messages

The Mail app provides easy ways to sort, move, or delete your email messages.

Sorting email messages

Customize how you sort your email messages.

In an email account inbox, tap  > **Sort**, and select from the sorting options.

Moving email messages to another folder

1. Switch to the email account you want to use.
2. Select the email messages you want to move.



To select all, select one email message first, and then tap  > **Select all**.

3. Tap **Move to**, and then select a folder.

Deleting email messages



1. Switch to the email account you want to use.
2. Select the email messages you want to delete.



To select all, select one email message first, and then tap  > **Select all**.

3. Tap **Delete**.

Searching email messages

1. From the Home screen, tap , and then find and tap **Mail**.
2. Tap .
3. If you want to narrow the scope for your search, tap , check the search options, and then tap **OK**. For example, you can focus the search on the email content, or filter email messages that have attachments or are tagged as high priority.
4. In the search box, enter the words you want to search for.
5. Tap a result to open the email message.

Searching for emails from a contact

Do you remember the sender, but can't find a particular email from him or her?

1. Switch to the email account you want to use.
2. Press and hold an email message from a contact.
3. Tap **Show all mail from sender**. A list of email messages from that contact appears.

Working with Exchange ActiveSync email

Enjoy the powerful email features of Microsoft Exchange ActiveSync right on HTC One X9. Flag important email messages, set your out of the office reply, or send invites to your next team meeting while you're on the go.

Flagging an email

1. From the Home screen, tap , and then find and tap **Mail**.
2. Switch to your Exchange ActiveSync account.
3. While viewing the inbox, tap the flag icon that appears beside an email message or conversation.



To flag an email message inside a conversation, tap  to expand the conversation, and then tap the flag icon of the email message.

Setting your Out of the office status

1. Switch to your Exchange ActiveSync account.
2. Tap  > **Out of the office**.
3. Tap your current office status, and then select **Out of the office**.
4. Set the dates and times.
5. Enter the auto-reply message.
6. If you want a different auto-reply message for recipients outside your organization, tap the **Send replies to external senders** option, and then enter the auto-reply message in the box.
7. Tap **Save**.

Sending a meeting request



1. Switch to your Exchange ActiveSync account.
2. Tap  > **New meeting invitation**.
3. Enter the meeting details.
4. Tap **Save**. Or tap **Send** if you've invited people to the meeting.

Adding an email account

Set up additional email accounts such as another Microsoft Exchange ActiveSync account or an account from a Web-based email service or email provider.



If you're adding a Microsoft Exchange ActiveSync or a POP3/IMAP email account, ask your network administrator or email service provider for additional email settings that you may need.

1. From the Home screen, tap , and then find and tap **Mail**.
2. Tap  > **Add account**.
3. Select an email account type from the list of email providers. Otherwise, tap **Other (POP3/IMAP)**.
4. Enter the email address and password for your email account, and then tap **Next**.



Some email accounts allow you to set the sync schedule. By default, HTC One X9 uses Smart Sync to save battery power. See [What is Smart Sync?](#) on page 133.

5. Enter a name for your email account, and then tap **Finish setup**.

What is Smart Sync?

Smart Sync automatically extends the sync time the longer the Mail app is inactive. Set your email account to Smart Sync when you don't need to check new email messages frequently. Smart Sync helps save battery power.

If you want to receive email messages as they arrive, select another **Peak time sync** and **Off-peak sync** schedule in the email account's **Sync, Send & Receive** settings.

Google Search and apps

Google Now

Getting instant information with Google Now

Do you want to check the weather or your morning commute time before you start your day? Google Now™ delivers quick and up-to-date information that matters to you—all without the search.

Depending on your location, time of day, and previous Google searches, Google Now displays information cards that include:

- The day's weather and the weather forecast for upcoming days.
- The traffic conditions on your way to work or your commute back home.
- The directions and travel time to your next appointment.
- The next train or bus arriving at your platform or bus stop.
- Your favorite team's score and stats while you enjoy the game.

Open the Google Search app to use Google Now. From the Home screen, tap , and then find and tap **Google**. Or tap the Google search bar widget when available.

Setting up Google Now



Before setting up Google Now:



- Make sure that you're signed in to your Google account.
- Turn location services on and make sure that you have an Internet connection.

1. From the Home screen, tap , and then find and tap **Google**.
2. Tap **Get started**. Or if you've previously set up Google Now on HTC One X9 and turned it off, tap **Get Now cards > Set up**.
3. Read the information screen and then tap **Yes, I'm in**. Google Now information cards will start to appear on the Google search screen.
4. Swipe up the screen to see all available information cards.
5. To dismiss a card, swipe it right.

Depending on the information that you've allowed to share, more information cards will appear on the Google search screen as you use HTC One X9 to search the Web, create appointments, set reminders, and more.

Changing card settings

You can easily customize the settings of Google Now cards to suit your information needs. For example, you can change the weather units in the Weather card or your transportation mode in the Traffic card.





1. From the Home screen, tap , and then find and tap **Google**.
2. Do any of the following:
 - To change the settings of a specific card, tap  and then tap an action.
 - To change specific information such as your work address, sports teams, or stocks you follow, tap , and then tap **Customize Google Now**. Choose the information you want to change.

Setting reminders in Google Now

Creating reminders in Google Now is an easy way to keep tab of things to do. You can set time or location-based reminders. When the reminder time is up or when you've arrived at the specified location, Google Now displays the Reminder card in the Google search screen and sounds a notification to alert you.



This feature may not be available in all languages.

1. From the Home screen, tap , and then find and tap **Google**.
2. Tap , and then tap **Reminders**.
3. Tap .
4. Enter the reminder title, such as the task you want to be reminded of.
5. Select **Time** to set a time-based reminder or **Place** to set a location-based reminder.
6. Set the reminder time or location details.
7. Tap .

When the reminder time is due or when you've arrived at the location, the Reminder card will appear in the Google search screen. You can then dismiss or snooze the reminder.

Turning off Google Now

1. From the Home screen, tap  > **Settings** > **Google**.
2. Tap **Search & Now** > **Now cards**.
3. Tap the switch next to **Show cards**, and then tap **Turn off**.

Now on Tap

Use Now on Tap to search information while viewing emails and websites, listening to music, or even while exchanging text messages. Now on Tap lets you look for information about the screen you're on so you don't have to leave the app. Just press and hold  and Now on Tap shows you related information, apps, and actions.





This feature may not be available in all languages.

Turning on Now on Tap





Before turning on Now on Tap:

- Make sure that you're signed in to your Google Account and have set up Google Now. See [Setting up Google Now](#) on page 134 for details.
- Turn location services on and make sure that you have an Internet connection.

1. From the Home screen, tap , and then find and tap **Google**.
2. Tap  > **Settings** > **Now cards**.
3. Tap **Now on Tap**, and then tap **Turn on**.

Searching with Now on Tap

1. On the current app you're in, press and hold . Now on Tap analyzes the screen and shows a card with information, apps, or actions related to the searched item or location.
2. Tap an item on the card to view more information or perform an action. You can also say, "OK, Google" and say what you want to know about the searched item or location. For example, if Now on Tap searched for a restaurant, you can say "OK, Google. Take me to that restaurant" to get directions to that location.
3. To hide the information cards and return to the screen, press .

Turning off Now on Tap

1. From the Home screen, tap  > **Settings** > **Google**.
2. Tap **Search & Now** > **Now cards**.
3. Tap the switch next to **Now on Tap**.

Google Search

Searching HTC One X9 and the Web

You can search for information on HTC One X9 and on the Web. In the Google Search app, start your search by entering a keyword or by using Google Voice Search™.

To open Google Search, from the Home screen, tap , and then find and tap **Google**. Or tap the Google search bar widget when available.



Some apps, such as People or Mail, have their own search function, which you can use to search only within those apps.

Performing searches on the Web and HTC One X9

1. From the Home screen, tap , and then find and tap **Google**.

If you've already set up a Google account on HTC One X9, you will be given the option to sign in to Google Now.

2. In the search box, enter what you want to search for. As you type, matching items on HTC One X9 and suggestions from Google web search are shown.
3. If what you're searching for is in the list of suggestions, tap the item to search for it or open it in its compatible app.



You can also filter web search results by tapping any of the categories on the filter bar at the bottom of the screen.

Searching the Web with your voice

Use Google Voice Search to find information on the Web by speaking to HTC One X9.



This feature may not be available in all languages.

1. From the Home screen, tap , and then find and tap **Google**.
2. Say "OK, Google," and then say what you want to search for. After speaking, matching items from Google web search are shown.
3. If what you're searching for is in the list, tap the item to open it in its compatible app. Otherwise, say "OK, Google" to search again.

Setting search options

1. From the Home screen, tap  > **Settings** > **Google**.
2. Tap **Search & Now**.
3. Tap the search option you want to set.

To get help or provide feedback, tap .

Google apps

Google apps

Count on the suite of Google apps on HTC One X9 to help you get productive, surf the Internet, be entertained, and more.

Gmail

Gmail lets you send and receive email from your Google Accounts or from other email accounts—all in one convenient app.

Google Chrome

Use Google Chrome to surf the Internet, search the Web, and bookmark your favorite websites.

Google Drive

Store your photos, documents, and other files on Google Drive to access them on HTC One X9, your computer, and your other mobile devices. In addition to the default storage that you get from Google Drive, you may be eligible to receive additional online storage for free. Sign in to your Google Account on HTC One X9—and not from your computer or other non-HTC phones—to claim this offer.

Google Maps

Google Maps lets you track your current location, view real-time traffic situations, and receive detailed directions to your destination.

It also provides a search tool where you can locate places of interest or an address on a map, or view locations at street level.

Google Play Music

Google Play Music lets you create your own music library, play your favorite tracks, and purchase the latest albums or songs from thousands of artists around the world.

YouTube

Share your videos or check out the latest video sensations using the YouTube app.

Other apps

HTC Dot View

Personalizing HTC Dot View

If you bought the HTC Dot View™ case designed for HTC One X9, use its app to personalize what's seen through the case.

From the Home screen, tap , and then find and tap **HTC Dot View**.



The HTC Dot View app is available in Google Play. Make sure to install the latest app update.

Wallpaper

Choose a preset wallpaper, or create your own dotted wallpaper from a photo.

1. In the HTC Dot View app, tap  > **Themes**.
2. Choose a preset pattern as your wallpaper.

To create your own wallpaper, tap , and then choose whether to use an existing photo from Gallery or take a new photo. You can also add a wallpaper from the Themes app.

3. If you selected or taken a photo, crop the photo, and then tap **Done**.
4. Tap **Apply**.

For best results when creating your own wallpaper, use a simple image with distinct colors between the subject and background. For example, use an image that shows a high-contrast subject on a simple background.

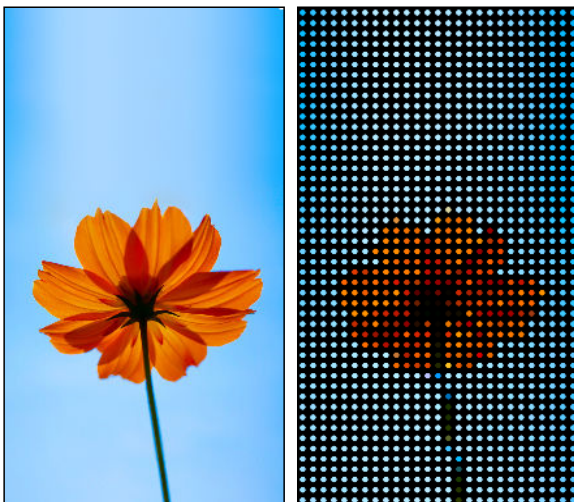

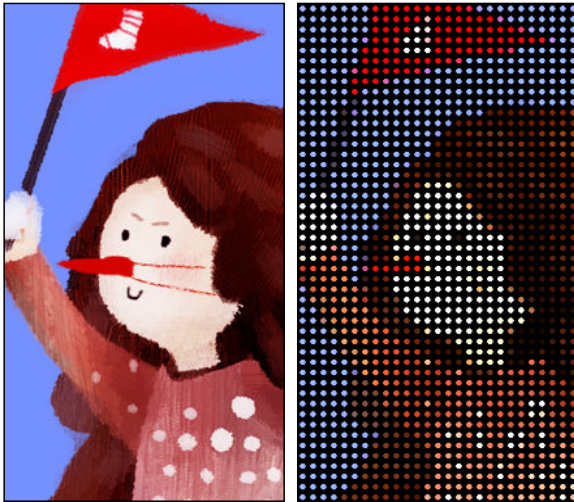

Types of notifications to display

Alerts for clock alarms, timers, and calendar events will automatically display through the HTC Dot View case. You can choose whether to display or hide notifications for apps—which include Mail, Messages, Phone, and more.

1. In the HTC Dot View app, tap **☰** > **Settings** > **Notification settings**.
2. Choose which app notifications you want to show or hide.

Not seeing recent calls on HTC Dot View?

By default, up to 3 received or dialed numbers will be displayed on HTC Dot View.

- If you're not seeing them, open the HTC Dot View app, tap **☰** > **Settings**, and then select **Show call history**.
- If you've set a screen lock with credentials, you need to select **Bypass security screen** to display the recent calls.

Music controls or app notifications not appearing on HTC Dot View?

Check if HTC Dot View Music Controls and Notifications are enabled in Settings.

1. Go to **Settings**, and then tap **Sound & notification** > **Notification access**.
2. Tap the **HTC Dot View Music Controls** and **HTC Dot View Notifications** options if they're not selected.

Need more details?

For more details, see the HTC Dot View Get started guide that comes with the case.

Clock

Using the Clock

Get more from the Clock app than just the regular date and time. Use HTC One X9 as a world clock to see the date and time in cities across the globe. You can also set alarms or track your time using the stopwatch or timer.

Setting an alarm



You can set up one or more alarms.

1. From the Home screen, tap , and then find and tap **Clock**.
2. On the Alarms tab, select the check box of an alarm and then tap that alarm.
3. Under Set alarm, use the scroll wheels to set the alarm time.
4. If you want the alarm for multiple days, tap **Repeat**.
5. Tap **Done**.



- To turn off an alarm, clear the check box of that alarm.
- If you need to set more than three alarms, tap **+**.

Setting the date and time manually

1. From the Home screen, tap , and then find and tap **Clock**.
2. On the World Clock tab, tap  > **Local time settings**.
3. Clear **Automatic date & time** and **Automatic time zone**, and then set the time zone, date, and time as required.







To display military time, choose the **Use 24-hour format** option.

Weather

Checking Weather

Use the Weather app and widget to check the current weather and weather forecasts for the next few days. In addition to your current location, you can view weather forecasts for other cities around the globe.



1. From the Home screen, tap , and then find and tap **Weather**. You'll see the weather for different cities, including where you are.
2. Tap a city to view weather information.
3. Swipe to the Hourly and Forecast tabs to view the forecast in your selected location.
4. To check the weather in other cities, tap , and then select the city you want.
5. To add more cities, tap  and then enter the location.
6. To change the temperature scale, update schedule, and more, tap  > **Settings**.

Your settings in the Weather app also control the weather information that is shown in the Clock and Calendar.

Voice recorder

Recording voice clips

Use Voice Recorder to capture information during lectures, interviews, or even to create your own audio log.

1. From the Home screen, tap , and then find and tap **Voice Recorder**.
2. Hold the microphone near the sound source.
3. Tap  to start recording a voice clip.



Voice Recorder can run in the background while you do other things on HTC One X9, except when you open other apps that also use audio functions.

4. Tap  to stop recording.

To play back the voice clip, tap .



To see your recorded voice clips, tap . Press and hold a voice clip to see options for sharing, setting it as a ringtone, and more.



FM Radio

Listening to FM Radio







Listen to your favorite radio stations using the FM Radio app.



You need to connect a headset first to the audio jack of HTC One X9 to use FM Radio. FM Radio uses the stereo headset as the FM radio antenna.

1. From the Home screen, tap , and then find and tap **FM Radio**.
2. Tap .

The first time you open FM Radio, it scans for local FM stations that you can listen to.

3. While you're listening to an FM station, you can:
 - Tap  or  to go to the next or previous station.
 - Drag the slider to tune in to a frequency on the FM band. To fine tune the radio frequency, tap  or .
 - Tap  to mark a radio station as a favorite. To see your other favorites and preset stations, tap .
4. To turn off FM Radio, tap .

Internet connections

Turning the data connection on or off

Turning your data connection off saves battery life and money on data charges.



You need a 4G/LTE plan to use your operator's 4G/LTE network for voice calls and data services. Check with your operator for details.

1. From the Home screen, tap , and then find and tap **Settings**.
2. Tap the Mobile data **On/Off** switch to turn the data connection on and off.



If you don't have the data connection turned on and you're also not connected to a Wi-Fi network, you won't receive automatic updates to your email, social network accounts, and other synced information.

Managing your data usage

If you're on a limited data allowance, it's important to keep track of the activities and apps that usually send and receive data, such as browsing the web, syncing online accounts, and sending email or sharing status updates.

Here are some other examples:

- Streaming web videos and music
- Playing online games
- Downloading apps, maps, and files
- Refreshing apps to update info and feeds
- Uploading and backing up your files to your online storage account
- Using HTC One X9 as a Wi-Fi hotspot
- Sharing your mobile data connection by USB tethering

To help you save on data usage, connect to a Wi-Fi network whenever possible and set your online accounts and emails to sync less frequently.

Turning data roaming on or off

Connect to your mobile operator's partner networks and access data services when you're out of your mobile operator's coverage area.



Using data services while roaming may be costly. Check with your mobile operator for data roaming rates before you use data roaming.



1. From the Home screen, tap , and then find and tap **Settings**.
2. Tap **Mobile data**.
3. Select or clear the **Data roaming** option.

Keeping track of your data usage

Monitor your data usage to help prevent going over your monthly data allowance.





Data usage measured by HTC One X9 may differ from, and be less than, your actual data usage.

1. From the Home screen, tap , and then find and tap **Settings**.
2. Under Wireless & Networks, tap **More**.
3. Tap **Data usage**.
4. Tap  to select a card slot.
5. On the Mobile tab, select **Limit mobile data usage** and tap **OK** to automatically disable your data connection when you reach the set limit.
6. Drag the upper LIMIT line to set your monthly data limit.
7. Select **Alert me about data usage**, and then drag the lower ALERT line to set an alert before you reach your monthly data limit.
8. Tap **Reset data usage**, and then set the day of the month when your usage cycle resets. This date is usually the start of your monthly billing cycle.



If you're connecting HTC One X9 to another portable Wi-Fi hotspot, tap  > **Mobile hotspots** to restrict background data from downloading that may incur extra data fees.

Viewing the data usage of apps

1. From the Home screen, tap , and then find and tap **Settings**.
2. Under Wireless & Networks, tap **More**.
3. Tap **Data usage**.
4. Tap  to select a card slot.
5. Scroll down the screen to see a list of apps and their data usage info.
6. Tap an app to see more details.

Wi-Fi connection

To use Wi-Fi, you need access to a wireless access point or “hotspot”.





The availability and strength of a Wi-Fi signal varies depending on objects the Wi-Fi signal has to pass through (such as buildings or a wall between rooms).

Turning Wi-Fi on or off

1. From the Home screen, tap , and then find and tap **Settings**.
2. Tap the Wi-Fi **On/Off** switch to turn Wi-Fi on or off.
3. Tap **Wi-Fi** to see a list of detected wireless networks.



- To manually scan for Wi-Fi networks, tap  > **Scan**.
- If the wireless network that you want is not listed, tap  > **Add network** to manually add it.

Connecting to a Wi-Fi network

1. Turn Wi-Fi on, and check the list of detected Wi-Fi networks.
See [Turning Wi-Fi on or off](#) on page 146.
2. Tap a Wi-Fi network you want to connect to.
3. If you selected a secured network, enter the network key or password.
4. Tap **Connect**. You'll see the Wi-Fi icon  in the status bar when connected.

Connecting to a Wi-Fi network via WPS

If you're using a Wi-Fi router with Wi-Fi Protected Setup (WPS), you can connect HTC One X9 easily.

1. Turn Wi-Fi on, and check the list of detected Wi-Fi networks.
See [Turning Wi-Fi on or off](#) on page 146.
2. Tap  > **WPS Push**, and then press the WPS button on your Wi-Fi router.





To use the Wi-Fi Protected Setup (WPS) PIN method, tap  > **WPS Pin Entry**.

Logging into a public Wi-Fi network automatically (WISPr)

You can set HTC One X9 to automatically log into a public Wi-Fi network that you regularly use. This saves you the trouble of going through the Wi-Fi provider's web authentication every time you connect to their Wi-Fi network. Just add your login credentials to the WISPr (Wireless Internet Service Provider roaming) settings.



The access point of the Wi-Fi network needs to support the WISPr web portal. Consult the Wi-Fi provider for details.

1. From the Home screen, tap , and then find and tap **Settings**.
2. If Wi-Fi connection is off, tap the Wi-Fi **On/Off** switch to turn it on.
3. Tap **Wi-Fi**.
4. Tap  > **Advanced**.
5. Under WISPr settings, select **Auto login** and then tap **WISPr account settings** > **Add a new account**.
6. Enter the service provider name, your login name (the full domain name), and password.
7. Tap  > **Save**
8. Connect to the public Wi-Fi network.



- If you have access to several public Wi-Fi networks, you can add up to five sets of login credentials to the WISPr accounts list.
- In the WISPr accounts list, press and hold an account to remove or edit it.

Connecting to VPN

Add virtual private networks (VPNs) so you can connect and access resources inside a local network, such as your corporate or home network.

Before you can connect HTC One X9 to your local network, you may be asked to:



- Install security certificates.
- Enter your login credentials.
- Download and install a required VPN app, if you're connecting to a secured enterprise network. Contact your network administrator for details.

Also, HTC One X9 must first establish a Wi-Fi or data connection before you can start a VPN connection.



Adding a VPN connection



You must first set a lock screen PIN, password, or pattern before you can use credential storage and set up the VPN.

1. From the Home screen, tap , and then find and tap **Settings**.
2. Under Wireless & Networks, tap **More**.
3. Tap **VPN** >  > **Add VPN profile**.
4. Enter the VPN settings and set them up according to the security details your network administrator gave you.
5. Tap **Save**.

Connecting to a VPN

1. From the Home screen, tap , and then find and tap **Settings**.
2. Under Wireless & Networks, tap **More**.
3. Tap **VPN**.
4. Tap the VPN that you want to connect to.
5. Enter your log in credentials, and then tap **Connect**. When you're connected, the VPN connected icon  appears in the notification area of the status bar.

You can then open the web browser to access resources such as your corporate network intranet.

Disconnecting from a VPN

- In Settings, tap **More** > **VPN**. Tap the VPN connection, and then tap **Disconnect**.
- Slide the Notifications panel open. If you see the VPN notification, tap it, and then tap **Disconnect**.

Using HTC One X9 as a Wi-Fi hotspot

Share your data connection with other devices by turning HTC One X9 into a Wi-Fi hotspot.



- Make sure the data connection is turned on.
- You must have an approved data plan associated with your account from your mobile service provider to use this service. Devices connected to your Wi-Fi hotspot use data from your subscribed data plan.

1. From the Home screen, tap , and then find and tap **Settings**.
2. Under Wireless & Networks, tap **More**.

3. Tap **Mobile network sharing** > **Portable Wi-Fi hotspot**.

The first time you turn on the Wi-Fi hotspot, you'll need to set it up.

4. Enter a hotspot name or use the default.

5. Enter a password or use the default.

The password is the key other people need to enter on their device so they can connect and use HTC One X9 as a wireless router.

6. To help make your Wi-Fi hotspot more secure, tap  > **Advanced**.

Choose from the available settings, and then press .

7. Tap the Portable Wi-Fi Hotspot **On/Off** switch to turn it on.

HTC One X9 is ready to be used as a Wi-Fi hotspot when you see  on the status bar.



To help minimize security risks, use the default security settings and set a strong and unique password.

Sharing your phone's Internet connection by USB tethering

No Internet connection available for your computer? No problem. Use the data connection of HTC One X9 to connect to the Internet.



- To make sure that the USB drivers for HTC One X9 are up-to-date, install the latest version of HTC Sync Manager on your computer.
- Make sure you have a USB tethering service enabled by your mobile operator.
- You may need to have USB tethering added to your data plan, and it may incur additional cost. Contact your mobile service provider for details.
- Make sure that mobile data is turned on.

1. Connect HTC One X9 to your computer using the provided USB cable.

2. From the Home screen, tap , and then find and tap **Settings**.

3. Under Wireless & Networks, tap **More**.

4. Tap **Mobile network sharing** > **USB connection** > **USB tethering**.

Wireless sharing

HTC Connect

What is HTC Connect?

With HTC Connect, wirelessly stream music or video from HTC One X9 to your speakers or TV by just swiping up the screen with 3 fingers.

You can stream media to any of the following types of devices:

- Blackfire[®] compliant multi-room speakers
- Multi-room speakers that support the Qualcomm[®] AllPlay[™] smart media platform
- DLNA[®] compatible speakers and TV
- Miracast[™] compatible display devices
- Chromecast[™] compatible display devices.
- Bluetooth speakers
- HTC certified consumer electronic devices or accessories that have the HTC Connect logo:



Some devices may need to be paired before you can share to them.

To see a list of supported devices or accessories, go to htc-connect.com/certified-devices.html. For more information about HTC Connect, see www.htc-connect.com.

Using HTC Connect to share your media

Before you start, make sure you have set up your speakers, TV, or appliance to connect to your Wi-Fi network. Refer to its documentation on how to set it up.

1. Open and play any music or other media content that you want to share from HTC One X9.
2. Swipe up with three fingers on the screen.

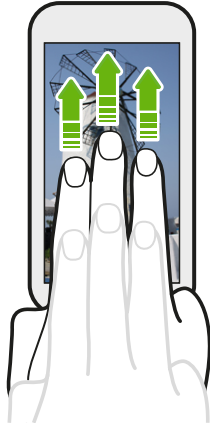

3. Choose the device you want to connect to.

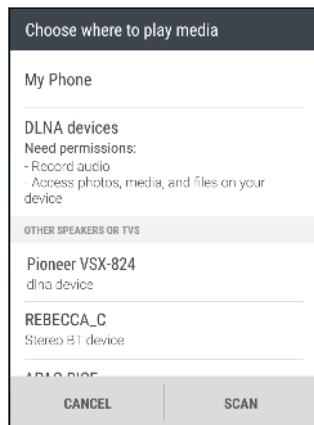

4. Once connected, use your phone to control the volume, pause or resume playback, and more.
5. To stop wireless media sharing and disconnect from the device, swipe down with three fingers on the screen.

Streaming music to Blackfire compliant speakers



Play music simultaneously to multiple Blackfire compliant speakers from HTC One X9.

Before you start, make sure your speakers are connected to your Wi-Fi network. Refer to the documentation that comes with your speakers to set up and connect them to your Wi-Fi network.

1. After connecting your speakers to your Wi-Fi network, open a music app on HTC One X9.
2. Swipe up with three fingers on the screen.
HTC One X9 then turns Wi-Fi on automatically and scans for media devices on your Wi-Fi network. You'll see the available speakers listed.
3. Tap the speaker you want to connect to.
4. In the music app, start playing music. You'll then hear the music play from the speaker you've selected.
5. To switch between speakers or to group them, swipe up the screen again with three fingers.
 - To stream music to another speaker, just tap it.
 - To group speakers so that music plays through them at the same time, tap the **Group** button next to a speaker name, select the other speakers you want to group it with, and then tap **OK**.

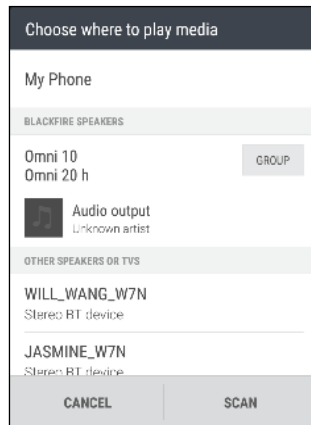

Renaming the speakers

You can rename your Blackfire compliant speakers in Settings.

1. Make sure the speakers are connected to your Wi-Fi network.
2. From the Home screen, tap **⋮** > **Settings** > **HTC Connect**.
HTC One X9 then turns Wi-Fi on automatically and scans for media devices on your Wi-Fi network. You'll then see the available Blackfire speakers listed.
3. Tap **⋮** next to a speaker name.
4. Enter the new speaker name, and then tap **Done**.

Streaming music to speakers powered by the Qualcomm AllPlay smart media platform

Before you start, make sure your speakers are connected to your Wi-Fi network. Refer to the documentation that comes with your speakers to set up and connect them to your Wi-Fi network.

1. After connecting your speakers to your Wi-Fi network, open a music app on HTC One X9.
2. Swipe up with three fingers on the screen.
HTC One X9 then turns Wi-Fi on automatically and scans for media devices on your Wi-Fi network. You'll then see the available speakers listed.
3. Tap the speaker you want to connect to.
4. In the music app that you're using, start playing music. You'll then hear the music play from the speaker you've selected.
5. To switch between speakers or to group them, swipe up the screen again with three fingers.
 - Just tap another speaker to stream music to it.
 - To group speakers so that music plays through them at the same time, tap the **Group** button next to a speaker name, select the other speakers you want to group it with, and then tap **OK**.

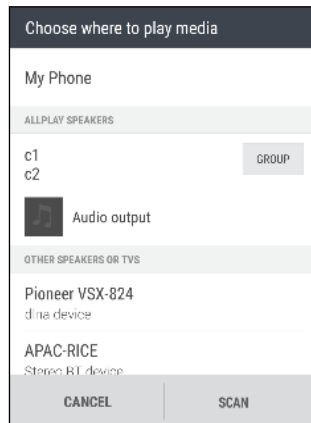

Bluetooth

Turning Bluetooth on or off

1. From the Home screen, tap , and then find and tap **Settings**.
2. Tap the Bluetooth **On/Off** switch to turn the Bluetooth connection on and off.
3. Tap **Bluetooth** to see a list of available devices.



Turn off Bluetooth when not in use to save battery power, or in places where using a wireless device is prohibited, such as on board an aircraft and in hospitals.

Connecting a Bluetooth headset

You can listen to music over a Bluetooth A2DP stereo headset, or have hands-free conversations using a compatible Bluetooth headset.



Before you connect your headset, make it discoverable so HTC One X9 can find it. Refer to your headset manual for details.

1. Turn Bluetooth on and check the list of available devices.
See [Turning Bluetooth on or off](#) on page 153.
2. If you don't see your headset listed, tap **Scan for devices** to refresh the list.
3. Tap the name of your headset in the Available Devices section. HTC One X9 pairs with the headset and the headset connection status is displayed in the Paired Devices section.
4. If prompted to enter a passcode, try 0000 or 1234, or consult the headset documentation to find the passcode.

When the Bluetooth headset is connected, you'll see  in the status bar.

Reconnecting a Bluetooth headset

Normally, you can easily reconnect your headset by switching on Bluetooth on HTC One X9, and then turning on the headset.

However, you might have to connect manually if your headset has been used with another Bluetooth device.

1. Turn Bluetooth on and check the list of paired devices.
See [Turning Bluetooth on or off](#) on page 153.
2. Tap the headset's name in the Paired Devices section.
3. If prompted to enter a passcode, try 0000 or 1234, or consult the headset documentation to find the passcode.

If you still cannot reconnect to the headset, follow the instructions in [Unpairing from a Bluetooth device](#) on page 154, and then follow the steps under [Connecting a Bluetooth headset](#) on page 154.

Unpairing from a Bluetooth device

1. Turn Bluetooth on and check the list of paired devices.
See [Turning Bluetooth on or off](#) on page 153.
2. In the Paired devices section, tap  next to the device to unpair.
3. Tap **Unpair**.

Receiving files using Bluetooth

HTC One X9 lets you receive various files with Bluetooth, including photos, music tracks, contact info, calendar events, and documents such as PDFs.



Refer to the device's documentation for instructions on sending information over Bluetooth.

1. Turn Bluetooth on.

See [Turning Bluetooth on or off](#) on page 153.

2. On the sending device, send one or more files to HTC One X9.
3. If asked, accept the pairing request on HTC One X9 and on the sending device. You may also be prompted to enter the same passcode or confirm the auto-generated passcode on both devices.

You'll then get a Bluetooth authorization request.

4. Tap **Pair**.
5. When HTC One X9 receives a file transfer request notification, slide the Notifications panel down, tap the incoming file notification, and then tap **Accept**.
6. When a file is transferred, a notification is displayed. Slide the Notifications panel down, and then tap the relevant notification to view the file.
7. You can also tap  > **Show received files** to view files received via Bluetooth.

NFC

Using NFC

With built-in NFC (near field communication) on HTC One X9, you can share content to another NFC-capable mobile device in an instant.



NFC may not be available in some phones.

Beam webpages, photos, contact information, and more by holding HTC One X9 and the other device back to back.

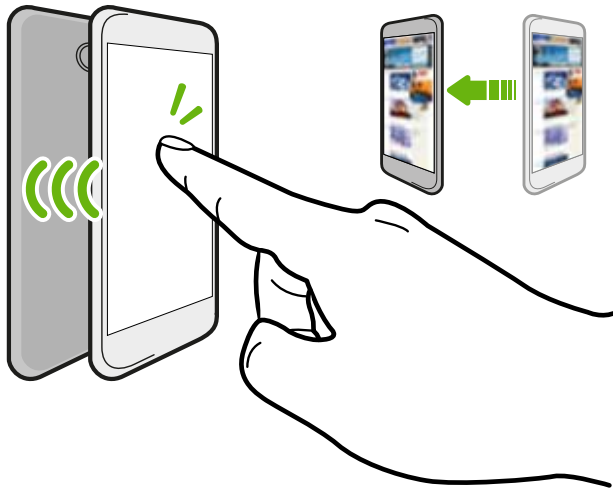

You can also use NFC for contactless payment. Availability of NFC payment depends on when your mobile operator launches this service. Contact your mobile operator for details.

Turning NFC on or off

1. Go to Settings, and then under Wireless & networks, tap **More**.
2. Tap the NFC **On/Off** switch to turn it on and off.

Beaming content



Make sure that both devices are unlocked and have NFC turned on. If the other device has an Android Beam™ option, make sure it is also turned on.

1. While viewing the content that you want to share, in the share options, tap **Android Beam**.
2. Hold HTC One X9 and the other phone back to back.

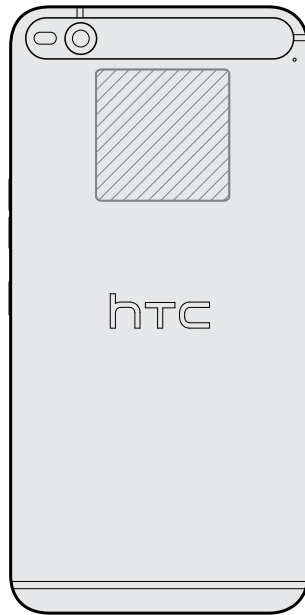

Make sure that the NFC area (shaded part) of HTC One X9 and the other phone's NFC area are close to one another. Experiment by slightly moving the phones until a connection is made.

3. Tap the screen.

The shared content appears on the other screen. For some items that you've shared (such as contact information), additional instructions on how to save the item will appear on the receiving device.

Settings and security

Toggling modes in HTC BoomSound

Turn on HTC BoomSound with Dolby Audio™ in Settings and experience a whole new level of mobile audio from the speakers on HTC One X9.

1. From the Home screen, tap , and then find and tap **Settings**.
2. Tap **HTC BoomSound with Dolby Audio** to toggle between Theater mode and Music mode.



HTC BoomSound with Dolby Audio is not available over HDMI, Bluetooth, Miracast, or USB audio out.

Using HTC BoomSound with headphones

Plug in your headphones and turn on HTC BoomSound with Dolby Audio to enjoy refined audio details in a more personal way.

1. From the Home screen, tap , and then find and tap **Settings**.
2. Plug your headphones into the headphone jack.
3. Tap the HTC BoomSound with Dolby Audio **On/Off** switch.
4. Tap **HTC BoomSound with Dolby Audio**, and then select an option from the Choose your headphones screen. HTC One X9 remembers the headphone profile you chose so you don't have to select it again next time.



HTC BoomSound with Dolby Audio is not available over HDMI, Bluetooth, Miracast, or USB audio out.

Turning location services on or off

In order to find your location on HTC One X9, you need to enable location sources.

1. From the Home screen, tap  > **Settings** > **Location**.
2. Tap the **On/Off** switch to turn location services on and off.
3. Under Location sources, select the location mode you want. For example, for a better estimate of your location, choose **High accuracy**. To save battery power, choose **Battery saving**.

Turning off a location source (for example GPS) means no applications on HTC One X9 will collect your location data through that location source. However, third party applications may collect —

and HTC One X9 may continue to provide — location data through other sources, including through Wi-Fi and signal triangulation.

Do not disturb mode

Use Do not disturb mode to reject calls, and silence audible alerts and notifications, but still keep a data connection available.

1. With two fingers, swipe down from the top of the screen to open Quick Settings.



2. Tap .
3. Tap **Total silence**, **Alarms only**, or **Priority only** depending on if you want to allow exceptions. When **Priority only** is selected, you can receive messages or calls from contacts in your exceptions list.
4. Tap **Until you turn this off** if you want to turn off Do not disturb by yourself or tap **+** or **—** to set the number of hours before Do not disturb turns off automatically.
5. Tap **Done** to activate it.

The Do not disturb icon  will appear in the status bar.





When the screen is on, press VOLUME and then tap **End now** to turn off Do not disturb mode quickly.



When Do not disturb is on, the notification LED will not flash.



Allowing notifications and contacts to bypass Do not disturb mode

Add important contacts to an exceptions list so you can still receive their calls and messages even when Do not disturb mode is on.

1. From the Home screen, tap  > **Settings** > **Sound & notification**.
2. Tap **Do Not Disturb** > **Priority only allows**.
3. Tap the **On/Off** switch next to the items you wish to allow.
4. Tap **Messages from** or **Calls from** to select who can contact you.
5. Tap **Manage approved contacts**, and then tap **+** to add contacts to your exceptions list.
To remove contacts or numbers from the list, tap  > **Remove contacts**.

Setting a Do not disturb schedule

Schedule Do not disturb to turn on automatically and how long will it last. For example, you can set it to turn on during a weekly meeting.

1. From the Home screen, tap  > **Settings** > **Sound & notification**.
2. Tap **Do Not Disturb** > **Schedules**.
3. Tap  **Add rule**.
4. Enter a name for the rule, and then select whether to base it on time or an event.

Time rule	<ul style="list-style-type: none"> ▪ Set the days. ▪ Set the start and end times. ▪ Select a Do not disturb level.
Event rule	<ul style="list-style-type: none"> ▪ Select a calendar you want to make the rule for. ▪ Set a condition for the type of reply. ▪ Select a Do not disturb level.



You can turn a schedule on or off by tapping the **On/Off** switch when viewing the details of the schedule.

Airplane mode

When you enable Airplane (Flight) mode, all wireless radios on HTC One X9 are turned off, including the call function, data services, Bluetooth, and Wi-Fi.

When you disable Airplane mode, the call function is turned back on and the previous state of Bluetooth and Wi-Fi is restored.



- You can manually turn Bluetooth and Wi-Fi back on after enabling Airplane mode.
- If USB tethering is turned on, enabling Airplane mode turns it off. You need to manually turn USB tethering on after you disable Airplane mode.

Do any of the following to turn Airplane mode on or off:

- Press and hold **POWER**, and then tap **Airplane mode**.
- With two fingers, swipe down from the status bar to open the Quick Settings panel. Tap the **Airplane mode** tile to turn airplane mode on or off.

When enabled, the Airplane mode icon  is displayed in the status bar.

Automatic screen rotation



Automatic rotation is not supported in all applications.

1. From the Home screen, tap  > **Settings** > **Display & gestures** or **Display, gestures & buttons**.
2. Select or clear the **Auto-rotate screen** option to turn it on or off.

Setting when to turn off the screen

After a period of inactivity, the screen turns off to conserve battery power. You can set the idle time before the screen turns off.

1. From the Home screen, tap  > **Settings** > **Display & gestures** or **Display, gestures & buttons**.
2. Tap **Screen timeout**, and then tap the time before the screen turns off.

Screen brightness

1. From the Home screen, tap  > **Settings** > **Display & gestures** or **Display, gestures & buttons**.
2. Tap **Brightness level**.
3. With the **Automatic brightness** option selected, drag the slider to set the maximum brightness level. This sets a limit on how bright the screen will be when **Automatic brightness** is selected.
4. To set the brightness manually, clear the **Automatic brightness** option, and then drag the brightness slider to the left to decrease or to the right to increase the screen brightness.

Touch sounds and vibration

Some people like the sound or vibration feedback they get when touching the screen, and some don't. You can turn on or off various types of touch sounds and vibration on HTC One X9.

- Touch tones when tapping the phone dial pad
- Touch sounds when tapping onscreen items
- Screen lock sounds
- Pull-to-refresh sounds
- Vibration when pressing hardware buttons
- Touch sound and vibration when tapping the HTC Sense keyboard

Turning touch sounds and vibration on and off

1. From the Home screen, tap  > **Settings** > **Sound & notification**.
2. Under **System**, select the option you want to turn on or off.

Turning off keyboard sounds and vibration

1. From the Home screen, tap  > **Settings** > **Language & keyboard**.
2. Tap **HTC Sense Input**.
3. Tap **Sound feedback** and then select **None** to turn off keyboard sounds.
4. Clear the **Vibration feedback** option to turn off keyboard vibration.

Changing the display language

Changing the language adjusts the keyboard layout, date and time formatting, and more.

1. From the Home screen, tap  > **Settings** > **Language & keyboard**.
2. Tap **Language**, and then choose the language you want to use.

Installing a digital certificate

Use client and Certificate Authority (CA) digital certificates to enable HTC One X9 to access VPN or secured Wi-Fi networks, and also to provide authentication to online secure servers. You can get a certificate from your system administrator or download it from sites that require authentication.



- You must set a lock screen PIN or password before installing a digital certificate.
- Some apps such as your browser or email client let you install certificates directly in the app. See the app's help for details.

1. Save the certificate file in the root folder on HTC One X9.
2. From the Home screen, tap  > **Settings** > **Security**.
3. Tap **Install from storage**.
4. Browse to the certificate and select it.
5. Enter a name for the certificate and select how it will be used.
6. Tap **OK**.

Disabling an app

Apps, even if not used often, may be running in the background and downloading data. If an app cannot be uninstalled, you can disable it.

1. From the Home screen, tap  > **Settings** > **Apps**.
2. Tap the app, and then tap **Disable**.

Controlling app permissions



When you open apps the first time, you'll be prompted to grant them permissions to access certain data or features, such as contacts or the microphone. This gives you more control over which apps have authorized access.

- If you suspect a certain app of being malicious or requesting unnecessary permissions, you should choose **Deny** to protect your phone.
- If you choose **Deny** in a trusted app, you may not be able to use the app or access its full functionality. When this happens, go to Settings to change the app permissions.

1. From the Home screen, tap , and then find and tap **Settings**.
2. Tap **Apps**.
3. Tap the app you want to configure, and then tap **Permissions**.
4. Choose which permissions you want to turn on.

Setting default apps



In Settings, you can choose default apps for web browsing, text messaging, and more.

1. From the Home screen, tap , and then find and tap **Settings**.
2. Tap **Apps**.
3. Tap  > **Configure apps** > **Default apps**.
4. Choose your default assist and voice input, web browser, phone, and text messaging apps.

Setting up app links

If there's more than one app that can be opened when you tap a link—such as a shared social post or media link—you may be prompted to choose the app you want to use. When you're prompted after you've tapped a link, select an app, and then tap **Always** to set that app as the default app to use.

You can also go to Settings to see how app links have been set up for different apps and change them.

1. From the Home screen, tap , and then find and tap **Settings**.
2. Tap **Apps**.
3. Tap  > **Configure apps** > **App links**.

4. Tap the app you want to configure, and then tap **Open supported links**.
5. Select **Open in this app** to always open the app without being prompted when you tap a link.
You can also choose whether to always be prompted to choose the app or never use the app for opening links.

Managing your nano SIM cards with Dual network manager

From the Home screen, tap  > **Settings** > **Dual network manager**. You can turn either slot on or off, change the slot names, and more.

Choosing which nano SIM card to connect to the 4G/3G network

When you have two nano SIM cards inserted on your phone, only one card can connect to the 4G/3G network. The other card will connect to the 2G network only.

You can set which card you want to connect to the 4G/3G network.

1. From the Home screen, tap  > **Settings** > **Dual network manager**.
2. Tap **Preferred data network**.
3. Choose the card you want to connect to the 4G/3G network.

Assigning a PIN to a nano SIM card

You can help to protect the nano SIM card by assigning a Personal Identification Number (PIN).



Make sure you have the default PIN provided by your mobile operator before continuing.

1. From the Home screen, tap  > **Settings** > **Security**.
2. Select which card you want to assign a new PIN to.
3. Choose to lock the card, enter the default PIN of the card, and then tap **OK**.
4. To change the card PIN, tap **Change SIM PIN**.

Restoring a nano SIM card that has been locked out

If you enter the wrong PIN more times than the maximum number of attempts allowed, the card will become “PUK-locked.”

You need a Pin Unlock Key (PUK) code to restore access to HTC One X9. Contact your mobile operator for this code.

1. On the Phone dialer screen, enter the PUK code, and then tap **Next**.
2. Enter the new PIN you want to use, and then tap **Next**.
3. Enter the new PIN again, and then tap **OK**.

Accessibility features

HTC One X9 comes with features and settings that allow easy access and use of apps and functions.

Improve screen readability

If you have low vision, take advantage of these features to help improve screen readability.

- Increase the font size, use color inversion, or enable high-contrast text using the Accessibility settings. See [Accessibility settings](#) on page 166.
- Turn magnification gestures on. See [Turning Magnification gestures on or off](#) on page 166.
- Turn on automatic screen rotation. See [Automatic screen rotation](#) on page 161.

Get audible feedback when using the phone

Use TalkBack to hear audible feedback on what you do on your phone. See [Navigating HTC One X9 with TalkBack](#) on page 166.

Use your voice

You can use your voice to perform an action on HTC One X9.

- Search for information on the Web using Google Voice Search. See [Searching the Web with your voice](#) on page 137.
- Enter text with your voice. See [Entering text by speaking](#) on page 48.

Use Motion Launch

Motion Launch combines a motion and finger gesture to perform an action such as waking HTC One X9 from sleep mode or launching the camera. See [What is Motion Launch?](#) on page 37.

Open Camera with Motion Launch Snap. See [Auto launching the camera with Motion Launch Snap](#) on page 40.

Accessibility settings

Use these settings to turn accessibility functions or services on or off. When you've downloaded and installed an accessibility tool, such as a screen reader that provides voice feedback, you can also control them using these settings.

1. From the Home screen, tap  > **Settings** > **Accessibility**.
2. Tap or select the settings you want.

Turning Magnification gestures on or off

If you have low vision or would like to get a closer view of what's on the screen, use finger gestures to magnify portions of your phone's screen.

1. From the Home screen, tap  > **Settings** > **Accessibility**.
2. Tap **Magnification gestures** and read the instructions on how to use it.
3. Tap the **On/Off** switch to turn Magnification gestures on or off.

Navigating HTC One X9 with TalkBack

Use TalkBack if you need to navigate HTC One X9 by spoken feedback. When you touch the screen, HTC One X9 vibrates and gives you an audible response so you know what you are touching.



Not all languages are supported.

Turning TalkBack on

1. From the Home screen, tap  > **Settings** > **Accessibility**.
2. Tap **TalkBack**, and then tap the **On/Off** switch.
3. Read the TalkBack disclaimer and then tap **OK**.



A short tutorial explaining how to use TalkBack will begin playing after you turn on TalkBack.



TalkBack works best if you turn off automatic screen rotation.

Turning Explore by touch on or off

Explore by touch allows HTC One X9 to respond to shortcut gestures and screen touches with audible feedback. While Explore by touch is enabled when you turn on TalkBack, you can turn it off.

1. From the Home screen, tap  > **Settings** > **Accessibility**.
2. Tap **TalkBack**, and then tap  > **Settings**.
3. Under Touch exploration, clear the **Explore by touch** option.

You will no longer hear audible feedback from HTC One X9.

Using TalkBack gestures

When TalkBack is turned on and the Explore by touch setting is selected, the regular touch gestures are replaced by the TalkBack gestures.



Media gestures such as 3-finger swiping may not be available when TalkBack gestures are enabled.

Do one of the following:



Open an item	<ol style="list-style-type: none"> 1. Drag your finger on the screen to find and select the item. 2. Double-tap anywhere on the screen to open the item.
Move an item	<ol style="list-style-type: none"> 1. Drag your finger on the screen to find the item. 2. Double-tap anywhere on the screen, but don't lift your finger on the second tap. 3. Drag the item to a new spot and then lift your finger.
Scroll through a screen	Use two fingers to swipe up, down, left or right.
Unlock the lock screen	Use two fingers to swipe up from the bottom of the screen.
Open the Notifications panel	Use two fingers to swipe down from the top of the screen.

Assigning TalkBack shortcuts

TalkBack has customizable gestures that can be used to open the Notifications panel, view recent apps, access TalkBack controls, and more.



The steps below are described using the regular gestures. Use the corresponding TalkBack gestures if you already have TalkBack turned on.

1. From the Home screen, tap  > **Settings** > **Accessibility**.
2. Tap **TalkBack**, and then tap  > **Settings** > **Manage gestures**.
3. Tap any of the shortcut gestures, and then select an action.

Using TalkBack context menus

TalkBack has context menus for controlling continuous reading and global TalkBack controls. These menus can be accessed using TalkBack shortcut gestures.

1. Turn TalkBack on.
2. Do one of the following:
 - To open the continuous reading menu, use one finger to swipe up and right in one continuous movement.
 - To open the global context menu, use one finger to swipe down and right in one continuous movement.



If you already changed the TalkBack shortcut gestures, check your TalkBack settings for the appropriate gesture.

3. Press and hold anywhere on the screen.
4. Drag your finger around the screen to explore the options.



To cancel an action, drag your finger to your starting position.

Changing the TalkBack reading speed



The steps below are described using the regular gestures. Use the corresponding TalkBack gestures if you already have TalkBack turned on.

1. From the Home screen, tap  > **Settings** > **Accessibility**.
2. Tap **Text-to-speech output** > **Speech rate**.
3. Select a speech rate.



You can test the speech rate by tapping **Listen to an example**.

TalkBack language settings

1. From the Home screen, tap  > **Settings** > **Accessibility**.
2. Tap **Text-to-speech output** > **Google Text-to-speech Engine**, and do one of the following:

Select a different language	Tap Language .
Install a voice	Tap Install voice data , and then tap the language. Tap  next to the voice data you want to install. When installation is completed, press < twice and tap Language .

3. Select the language you want to use.



Not all languages are supported.

Trademarks and copyrights

©2015 HTC Corporation. All Rights Reserved.

Dolby Audio manufactured under license from Dolby Laboratories. Dolby, Dolby Audio, and the double-D symbol are trademarks of Dolby Laboratories.

HTC, the HTC logo, HTC One, the HTC One logo, HTC BlinkFeed, HTC BoomSound, HTC Connect, HTC Dot View, HTC Sense, Motion Launch, VideoPic, UltraPixel, Zoe, and all other HTC product and feature names are trademarks or registered trademarks in the U.S. and/or other countries of HTC Corporation and its affiliates.

Google, Android, Google Chrome, Google Drive, Google Maps, Google Now, Google Play, Google Voice Search, Google Wallet, and YouTube are trademarks of Google Inc.

Microsoft, Windows, ActiveSync, PowerPoint, Outlook.com, and Windows Media are either registered trademarks or trademarks of Microsoft Corporation in the United States and/or other countries.

The Bluetooth® word mark and logos are registered trademarks owned by Bluetooth SIG, Inc.

Wi-Fi® and Miracast are registered trademarks of the Wireless Fidelity Alliance, Inc.

LTE is a trademark of European Telecommunications Standards Institute (ETSI).

DLNA is a trademark or registered trademark of Digital Living Network Alliance. All rights reserved. Unauthorized use is strictly prohibited.

Qualcomm is a trademark of Qualcomm Incorporated, registered in the United States, and other countries and used with permission. AllPlay is a trademark of Qualcomm Connected Experiences, Inc., and used with permission.

BLACKFIRE RESEARCH™ is a Registered Trademark (No. 3,898,359) of BLACKFIRE RESEARCH CORP.

iCloud, iPhone, iTunes, Mac, and Mac OS are trademarks of Apple Inc. registered in the U.S. and other countries.

microSD is a trademark of SD-3C LLC.

All other trademarks and service marks mentioned herein, including company names, product names, service names and logos, are the property of their respective owners and their use herein does not indicate an affiliation with, association with, or endorsement of or by HTC Corporation. Not all marks listed necessarily appear in this User Guide.

The HTC Sync Manager software can be used with materials that you own or are lawfully authorized to use and/or duplicate. Unauthorized use and/or duplication of copyrighted material may be a violation of copyright law in the United States and/or other countries/regions. Violation of U.S. and international copyright laws may subject you to significant civil and/or criminal penalties. HTC Corporation shall not be held responsible for any damages or losses (direct or indirect) that you may incur as a result of using this software.

Screen images contained herein are simulated. HTC shall not be liable for technical or editorial errors or omissions contained herein, nor for incidental or consequential damages resulting from furnishing this material. The information is provided “as is” without warranty of any kind and is subject to change without notice. HTC also reserves the right to revise the content of this document at any time without prior notice.

No part of this document may be reproduced or transmitted in any form or by any means, electronic or mechanical, including photocopying, recording or storing in a retrieval system, or translated into any language in any form without prior written permission of HTC.

Index

A

- Accounts
 - syncing 109
- Airplane mode 160
- Alarms
 - setting 141
- Android Beam
 - See NFC
- Apps
 - arranging 57
 - grouping into a folder 57
 - hiding or unhiding 58
 - icons on Home screen 54
 - installing 26
 - installing from Google Play 25
 - installing from the web 26
 - on Home screen 54
 - restoring 26
 - uninstalling 27
 - updating 24
- Auto Selfie 69

B

- Backup
 - about 110
 - HTC Sync Manager 113
 - options 110
 - restoring backed up apps 26
- Battery
 - charging 17
 - checking usage 99
 - saving battery power 100
- BlinkFeed
 - See HTC BlinkFeed
- Bluetooth
 - connecting a Bluetooth headset 154
 - receiving information 155
- Burst mode 67

C

- Calendar 125–128
 - creating an event 126
 - dual time zone 125
 - meeting conflicts 126
 - meeting invitations 127
 - reminders 128
 - sending quick response 128
 - views 125
- Call history 92
- Camera
 - basics 64–66
 - capture modes 65
 - continuous shooting 67
 - flash 65
 - HDR 68
 - Hyperlapse 72
 - Pro mode 72
 - RAW Camera 73
 - recording a video 66
 - selfie 69, 70
 - slow motion 68
 - standby 64
 - sweep panorama 71
 - taking a photo 65
 - taking photo while recording 66
 - using volume buttons as controls 67
 - video resolution 66
 - Zoe camera 71
 - zooming 65
- Capture modes
 - switching to 65
- Capture screen 35
- Change phone language 162
- Clock 141
 - alarm 141
 - setting date and time 141
- Conference call 91
- Contacts
 - adding 118
 - copying contacts 21, 120

- importing contacts 21, 120
- transferring contacts 21, 120

Continuous shooting 67

Copy

- files 105

Copying

- text 44

D

Data connection

- data roaming 145
- sharing 149
- turning on or off 144
- usage 144

Data transferiPhone

- from iCloud 21

Data transfer

- from Android phone 20
- from iPhone 21
- transferring contacts 21

Display

- changing the time before the screen turns off 161
- screen brightness 161
- screen rotation 161
- Sleep mode 28

DNG RAW photos 73

Double exposure 85

E

Email

See Mail

Exchange ActiveSync

- flagging an email 132
- meeting request 133
- Out of office 132
- sending a meeting request 133

expanded storage 102

F

Face Fusion 87

Face unlock 41

Factory reset 116

Files

- copying 105

Finger gestures 30

Firmware

See Software update

FM Radio 143

- using 143

Folder

- grouping apps 57
- removing items 57, 58

FOTA

See Software update

G

Gallery 74, 77–85, 87

- creating animated gif 81
- custom effects 80
- editing photos 79
- Face Fusion 87
- Video Highlights
- See Zoe
- video trimming 77
- viewing photos and videos 74
- viewing photos and videos by event 74
- watching videos 77

Geotag 74

Gestures

- motion gestures 29
- touch gestures 30

Gmail 138

Google apps 138

Google Chrome

- Google Drive 138

Google Maps 138

Google Now 134, 135

- setting up 134
- turning off 135

Google Play

- installing apps 25
- refund 27

Google Voice Search 137

GPS (Global Positioning System)

See Location settings

Group messaging 95

H

Hands free 154

Hard reset

See Factory reset

HDR 68

Headphones

See Bluetooth

hearing impaired

- hearing aids 166
- sidetone 166

Home screen

- adding or removing widget panel 55
- apps 54
- arranging widget panels 55
- changing your main Home screen 56
- feeds 59
- folder 57
- launch bar 53
- rearranging widgets and icons 55
- removing widgets and icons 55
- shortcuts 54
- wallpaper 52
- widget panel 28
- widgets 54

Hotspot

See Wireless router

HTC BlinkFeed

- about 59
- adding regional editions 62
- deleting items 63
- posting to social networks 63
- selecting feeds 61
- setting up custom topics 62
- showing social network and app feeds 62
- turning on or off 60

HTC Clock 141

- setting an alarm 141

HTC Connect

- about 150
- streaming music to speakers 152, 153
- streaming music, videos, or photos to media devices 151

HTC Sense version 23**HTC Sync Manager 113****Hyperlapse 72****I****Idle screen**

See Lock screen

Internet connection

- VPN 147
- Wi-Fi 146
- wireless router 148

K**Keyboard**

- dictionary 47
- entering text 45
- entering text by speaking 48
- HTC Sense keyboard 45
- multi-language keyboard 46
- predictive text 46
- shortcuts 47
- speech recognition 48

L**Language**

- system language 162

Live Makeup 69**Location settings 158****Lock screen**

- answering a call 90
- dismissing an alarm 29
- opening an app 34
- rejecting a call 90
- unlocking 29

Low battery 100**Low storage 106****M****Mail**

- attachments 130
- carbon copy, blind copy (cc, bcc) 130
- deleting 131
- draft 130
- replying 130
- searching 132
- sending 130
- sorting 131

Mail folders

- moving email messages 131

Making calls

- calling 88

Master reset

See Factory reset

Media streaming

See HTC Connect

Meeting request 133**Messages**

- block box 97

- deleting a conversation 97
 - draft message 94, 95
 - forwarding 96
 - group SMS 95
 - locking 98
 - replying 95
 - secure box 96
 - sending 94
- microSD card 15
- MMS
- See Multimedia message
- Morph
- See Face Fusion
- Multimedia message
- attachment 94
 - group MMS 95
 - sending 94
- Google PlayMusic 138
- Music
- transferring from iPhone 114

N

- NFC (Near Field Communication) 156
- Notifications
- panel 43
- Now on Tap 136

O

- Online accounts
- adding accounts 109
 - removing accounts 109
 - syncing manually 109
 - what can you sync with 109

P

- Pair a Bluetooth headset 154
- People
- adding a new contact 118
 - contact groups 122
 - contact link suggestions 121
 - copying contacts 21, 120, 121
 - editing contacts 119
 - filtering your contacts 117
 - groups 122
 - importing contacts 21, 120
 - merging contact information 121

- personal profile 118
- sending contact information 122
- transferring contacts 21, 120

Phone calls

- blocking a call 92
- call history 92
- calling 88
- conference call 91
- emergency call 90
- extension number 89
- missed calls 89
- muting the microphone 91
- putting a call on hold 90
- receiving calls 90
- Smart Dial 88
- speakerphone 91
- speed dial 89

Phone information 23

Phone settings

- See Settings

Phone updates 23

Photo shapes 83

Photos

- custom effects 80
- transferring from computer 22
- transferring from iPhone 114
- viewing photos and videos 74
- viewing photos and videos by event 74

Power

- charging the battery 17
- checking battery usage 99
- saving power 100
- sleep mode 28

Print screen

- See Capture screen

Prismatic 84

PUK (PIN Unblock Key) 165

Q

Quick settings 22

R

Radio

- See FM Radio

RAW Camera 73

Raw Camera 73

Recent apps 34

Recording your voice 142

Reset 115, 116

Router

See Wireless router

S

Screen 28, 29, 35, 161

- adjusting brightness 161
- capture 35
- changing the time before the screen turns off 161
- idle screen 29
- rotation 161
- Sleep mode settings 161

Screen lock 40

Screen shot

See Capture screen

SD card 15

Search

- searching phone and Web 136
- voice search 137

Security

- protecting phone with screen lock 40
- security certificates 147

self-timer 70

selfie

- Auto Selfie 69
- Live Makeup 69
- self-timer 70
- Voice Selfie 70

Sense Home

- adding apps to widget 37
- changing addresses 36
- manually switching locations 36
- pinning apps in widget 37
- setting up widget 35
- smart folders in widget 37
- unpinning apps in widget 37
- widget 35

Settings

- About 23
- Accessibility 166
- display language 162
- Storage 102

Setup

- contacts from old phone 21
- first-time setup 19

- photos, music, videos from old phone 22

- restoring backup from cloud storage 19

Shapes 82

Sharing

- events 127
- text 45

Shortcuts 34

sidetone 166

Sleep mode 28

Slideshow

- highlight video 78

Slow motion video 68

Smart network sharing 149

SMS

See Messages

Soft reset 115

Software update 23

Sound

- ringtone, notifications, and alarm 52
- switching profiles 92

Speakerphone 91

Speed dial 89

Storage 102

Sweep panorama 71

Sync

- HTC Sync Manager 113

T

Tethering

See USB Tethering

Text message 94

Themes 49–51

- bookmarking 49
- creating 50
- deleting 51
- downloading 49
- editing 50
- finding 51
- mix and match 50
- sharing 51

time-lapse

See Hyperlapse

U

Upgrade

See Software update

USB Tethering 149

V

- Video Highlights
 - See Zoe
- VideoPic 66
- Videos
 - editing 77
 - playback speed 76
 - recording 66
 - taking photo while recording 66
 - transferring from computer 22
 - watching 77
- Voice input 48
- Voice Recorder 142
- Voice search 137
- Voice Selfie 70
- VPN 147, 148
 - adding a connection 148
 - connecting 148
 - disconnecting 148

W

- Waking up phone
 - through power button 28
- Wallpaper
 - changing 52
- Weather
 - checking weather 142
- Wi-Fi 146
 - connecting via WPS 146
 - turning on 146
- Widgets
 - adding 54
 - changing settings 54
 - rearranging 55
 - removing 55, 56
 - resizing 54
- Wireless media sharing
 - See HTC Connect
- Wireless router 148
- Word prediction 46
 - bilingual prediction 46

Y

- YouTube 138

Z

- Zoe camera 71