

SONY

# Quick Start Guide

NW-ZX2



## About the manuals

To see the detailed information about WALKMAN®, access to Help Guide on the internet.

[http://rd1.sony.net/help/dmp/nwzx2/h\\_cn/](http://rd1.sony.net/help/dmp/nwzx2/h_cn/)

While browsing is free, you may be charged a communication fee according to your carrier contract.

Regarding the basic operations, the customer support website URL and Important Information, refer to "How to Install and Read the Help Guide" section on this manual.



## Contents

Please check the items in the package.

- Walkman (1)
- USB cable (1)
- Leather Carrying Case (1)
- Spacer (1)
- Quick Start Guide (this manual)

Headphones and microSD Card are not supplied with your Walkman.

## About the genuine leather carrying case

- This product is made of genuine leather. Unlike artificial leather, genuine leather may have scratches, wrinkles, or vein marks on the surface. Every case has a unique appearance and color.
- Wrapping the headphone cord around the leather carrying case when storing may leave headphone cord marks as the leather is soft.
- When using cleaner, read the instructions carefully and try it on an inconspicuous part first.
- Do not use any type of solvents such as alcohol or thinner for cleaning. Doing so will cause color fading, deformation or degradation which may damage the leather carrying case.
- Moisture such as rain or sweat, or friction may cause discoloration or color migration to your clothes, etc.
- Do not use or store the leather carrying case in a location exposed to direct sunlight (such as in a car), extremely high/low temperatures, high humidity or dust.
- Be careful that your Walkman does not come in contact with the snap button of the leather carrying case when you put the Walkman in or remove it from the case. Otherwise, the Walkman may become scratched.

## Parts and Controls

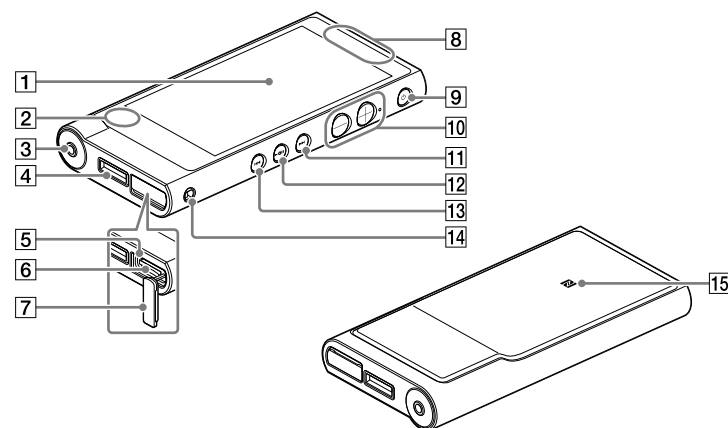

### 1 Screen (touch screen)

Touch (tap) icons, items, etc., on the screen to operate your Walkman.

### 2 Built-in microphone

### 3 Headphone jack

Push the headphone plug all the way in. If the headphones are connected improperly, the sound from the headphones will be impaired. Sound is not emitted from the headphones connected to the headphone jack when a Bluetooth connection is active. End the Bluetooth connection.

### 4 WM-PORT jack

Connect the USB cable (supplied) or other accessories that support WM-PORT (not supplied).

### 5 Access lamp

The access lamp is located under the microSD card slot cover.

### 6 microSD card slot

The microSD card slot is located under the microSD card slot cover. Open the cover before inserting a microSD card (not supplied). Insert a microSD card until it clicks into place to increase the available memory of your Walkman.

### 7 microSD card slot cover

### 8 Built-in antenna

Wi-Fi and Bluetooth antennas are built-in.

### 9 (Power)/Screen lock button

Press to turn the power on. Press and hold to turn the power off. Press to turn the screen on/off. Your Walkman will be reset if you press and hold the (Power) button for about 8 seconds.

### 10 Volume "+" and "-" buttons

Press the volume "+" button to turn up and the volume "-" button to turn down the volume.

There is a tactile dot beside the "+" button. Use it to help with button operations.

### 11 (Next) button

Skip to the next song, the next chapter of a video, or a scene playing 5 minutes later. If you press and hold the button, songs or videos are fast-forwarded.

### 12 (Play/Pause) button

Play back or pause songs or videos.

There is a tactile dot on the button. Use it to help with button operations.

### 13 (Previous) button

Skip to the previous (or current) song, the previous chapter of a video, or a scene that played 5 minutes ago. If you press and hold the button, songs or videos are fast-rewind.

### 14 Strap hole

This is used to attach a strap (not supplied).

### 15 N mark

Touch a Bluetooth audio device equipped with the NFC function to this mark.

## Charging the Battery

- 1 Use the supplied USB cable to connect your Walkman to a running computer and charge the Walkman.

Your Walkman turns on.

#### Note

- If a large battery symbol is displayed while you are charging your Walkman, the remaining charge is still too low for the Walkman to operate. The Walkman will start automatically after being charged for about 10 minutes.
- It takes about 4.5 hours to fully charge the battery.
- To prevent battery deterioration, charge the battery at least once every six months or every year.



## Turning On/Off Your Walkman

Turn off the power when not using your Walkman for an extended period of time.

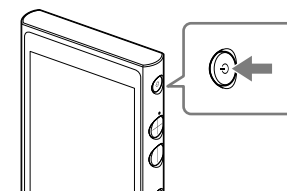

- 1 Press the (Power) button to turn on your Walkman. Press and hold the (Power) button to turn off your Walkman.
- 2 When turning off your Walkman, tap [Power off] - [OK].

## Turning On/Off the Screen

The screen will turn off if no operations are made for a certain period of time.

- 1 Press the (Power) button.

The lock screen will be displayed.

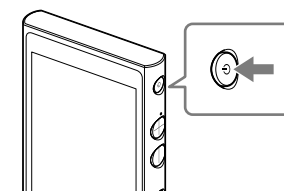

- 2 Drag (Lock) out of the circle.

Your Walkman is then unlocked, and the Home screen will be displayed. Press the (Power) button again to turn off the screen.

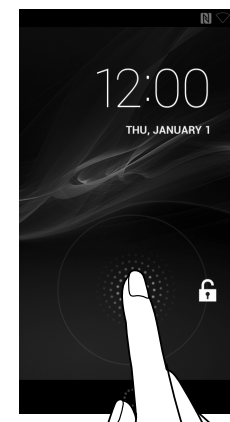

## Turning On/Off Wi-Fi

- 1 Swipe the status bar down and tap (Settings) - [SETTINGS].
- 2 Tap (Wi-Fi) - [ON]/[OFF].

## Turning On/Off the Bluetooth function

- 1 Swipe the status bar down and tap (Settings) - [SETTINGS].
- 2 Tap (Bluetooth) - [ON]/[OFF].

## Turning On/Off the NFC function

- 1 Swipe the status bar down and tap (Settings) - [SETTINGS].
- 2 Tap [More] and put a checkmark in the [NFC] checkbox/remove a checkmark from the [NFC] checkbox.



\* 4 5 4 5 6 1 8 1 1 \* (1)

## Home Screen

The Home screen is displayed by tapping .

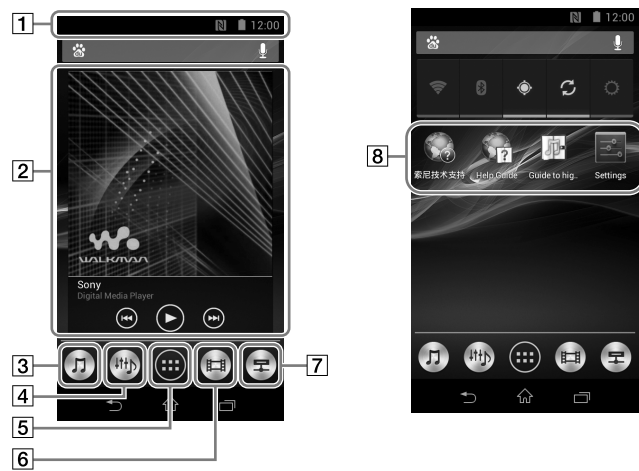

### 1 Status bar

Displays the status of your Walkman and notifications.

### 2 [Music player] widget

Play back music.

### 3 [Music player] shortcut

Play back music files transferred by Media Go or drag and drop.

### 4 [Sound adjustment] shortcut

Starts the sound adjustment application.

### 5 Apps

Displays all your applications and widgets.

### 6 [Video player] shortcut

Starts video player.

### 7 [DLNA] shortcut

Starts DLNA application.

### 8 Application shortcut

Starts application individually.

## How to Use the Touch Screen

Your Walkman screen is touch-sensitive. You can operate your Walkman by gestures such as tapping, pressing, and flicking the screen. Refer to the Help Guide for details.

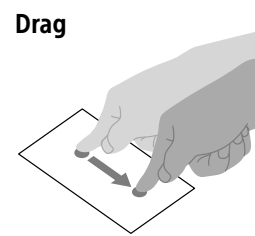
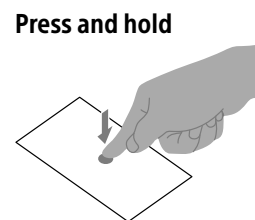
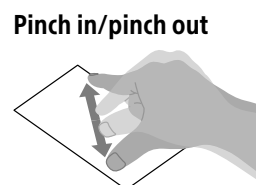
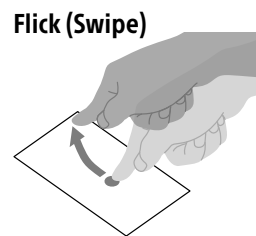
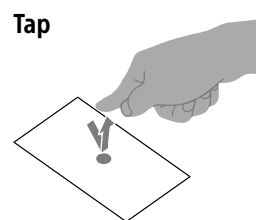

## How to Install and Read the Help Guide

Install the “Help Guide” on your computer. This contains basic operations of your Walkman, the customer support website URL, and how to transfer content such as music to the Walkman.

- 1 Connect your Walkman to a running computer.
- 2 Make sure that [USB storage in use] is displayed on the screen.

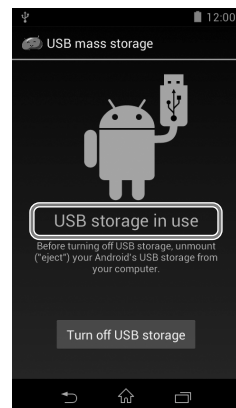

### Hint

- If [USB connected] is displayed, tap [Turn on USB storage].

### 3 Open the following folders and double-click the executable file on your Walkman.



- Windows 7 or earlier: [Start] – [Computer] – [WALKMAN] – [FOR\_WINDOWS] – [Help\_Guide\_Installer(.exe)].
- Windows 8: [Start screen] – [Desktop] – [File Explorer] – [Computer] – [WALKMAN] – [FOR\_WINDOWS] – [Help\_Guide\_Installer(.exe)].
- Windows 8.1: [Desktop] – [File Explorer] – [This PC] – [WALKMAN] – [FOR\_WINDOWS] – [Help\_Guide\_Installer(.exe)].
- Mac: [Finder] – [WALKMAN] – [FOR\_MAC] – [Help\_Guide\_Installer\_for\_mac].

### 4 Follow the on-screen instructions to complete the installation.

### 5 To read the Help Guide, double-click the shortcut or the alias icon generated on your computer.

## How to Use the Help Guide on Your Walkman

When you access the Internet, you can view the full version of the Help Guide on the web from your Walkman.

- 1 Tap  from the Home screen then tap  [Help Guide].

## Troubleshooting

If your Walkman does not function as expected, try the following steps to resolve the issue.



- 1 Find the symptoms of the issue in “Troubleshooting” in the Help Guide (HTML document), and try any corrective actions listed.
- 2 Connect your Walkman to your computer to charge the battery.
- 3 Press and hold the  button for about 8 seconds.

Symptom	Cause/Remedy
The computer does not recognize your Walkman.	<ul style="list-style-type: none"><li>• If the remaining battery power is low, charge the battery.</li><li>• When you use your Walkman for the first time, or if you have not used the Walkman for a long time, it may take a few minutes to be recognized by the computer. Check that the computer recognizes the Walkman after you have connected it to the computer for about 10 minutes.</li><li>• Make sure that the USB cable is connected to the computer properly and securely.</li><li>• Use the supplied USB cable.</li><li>• Connecting your Walkman via a USB hub may not work. Connect the Walkman directly to the USB connector on your computer.</li><li>• Make sure that the USB connection is not turned off. Drag the status bar, then tap [Turn on USB storage] on the notification panel followed by [Turn on USB storage] then [OK].</li><li>• If the approaches listed above fail to resolve the issue, press and hold the  button for about 8 seconds to reset your Walkman then try the USB connection again.</li></ul>
Your Walkman becomes unstable while it is connected to the computer.	<ul style="list-style-type: none"><li>• Your Walkman may be unstable if using a USB hub or USB extension cable. Connect the Walkman directly to the computer's USB port.</li></ul>
Your Walkman gets warm.	<ul style="list-style-type: none"><li>• Depending on the way you use your Walkman, the Walkman may become warm while the battery is being charged or the Walkman is performing intensive data processing. This is not a malfunction.</li></ul>

## Specifications

Starting up time from battery shortage condition  
About 10 minutes  
Temperature of battery use  
5 °C to 35 °C (41 °F to 95 °F)

## Precautions

You must accept the terms of the End User License Agreement when you use your Walkman for the first time. To read them again later, swipe the status bar down and tap  [SETTINGS] –  [About device] – [Legal information] – [Sony EULA].

### Information on laws and trademarks

- For information on laws, regulations and trademark rights, refer to “Important Information” contained in the supplied software. To read it, install the supplied software on your computer.
- Google, Android and other marks are trademarks of Google Inc.
- The Android robot is reproduced or modified from work created and shared by Google and used according to terms described in the Creative Commons 3.0 Attribution License.

### About the headphones

- Avoid playing the unit at so loud a volume that extended play might affect your hearing.
- At a high volume outside sounds may become inaudible. Avoid listening to the unit in situations where hearing must not be impaired, for example, while driving or cycling.
- As the headphones are of open-air design, sounds go out through the headphones. Remember not to disturb those close to you.

### Owner's Record

The model and serial numbers are located on the back of the player. Record them in the space provided below. Refer to these numbers in the spaces whenever you call upon your Sony dealer regarding this product.  
Model No. \_\_\_\_\_  
Serial No. \_\_\_\_\_

Please do not use the 5 GHz Wi-Fi function outdoors.  
The use of this function is prohibited by law in some countries/areas.

Design and specifications are subject to change without notice.