



**Handbook for
Palm™ Tungsten™ W
Handhelds**

Copyright

© 2002 Palm, Inc. All rights reserved. HotSync, MultiMail, PalmModem, and Palm OS are registered trademarks, and the HotSync logo, Palm, the Palm logo, Palm Powered, and VersaMail are trademarks of Palm, Inc. Palm, Inc. uses the Bluetooth trademark under express license from Bluetooth SIG, Inc., U.S.A. All other brand names are trademarks or registered trademarks of their respective owners.

Disclaimer and Limitation of Liability

Palm, Inc. assumes no responsibility for any damage or loss resulting from the use of this handbook.

Palm assumes no responsibility for any loss or claims by third parties which may arise through the use of this software. Palm, Inc. assumes no responsibility for any damage or loss caused by deletion of data as a result of malfunction, dead battery, or repairs. Be sure to make backup copies of all important data on other media to protect against data loss.

IMPORTANT Please read the End User Software License Agreement with this product before using the accompanying software program(s). Using any part of the software indicates that you accept the terms of the End User Software License Agreement.

Software Download Available

Palm™ Desktop software is supplied on a CD-ROM disc. If you do not have access to a CD-ROM drive for your computer, you can download the Palm Desktop software from www.palm.com/support/intl.

Contents

About This Book	1
Chapter 1: Welcome	3
System requirements	4
Minimum requirements: Windows computers	4
Minimum requirements: Mac computers	4
Wireless service	5
Making a call in a medical or safety emergency	6
Software Download Available	6
Compatibility of third-party applications	6
Finding information	7
Chapter 2: Exploring Your Handheld	9
Locating handheld components	10
Locating front panel controls	10
Using the indicator light	12
Locating back panel components	13
Adding an expansion card	14
Using the backlight	15
Chapter 3: Navigating and Entering Data	17
Tapping	17
Using the navigator	18
Using the keyboard	19
Typing capital letters	20
Accessing international and special characters	20
Using the Function key	22
Using menu commands	23
Using ShortCuts	24
Using elements of the handheld interface	24
Beaming data	26
Using your computer keyboard	29

Importing data	29
Importing data from a Windows computer	29
Importing data from a Mac computer	31
Chapter 4: Working with Applications	33
Opening applications	33
Other ways to open applications	34
Opening expansion card applications	34
Switching between applications	34
Categorizing applications	35
Changing the Applications Launcher display	36
Copying applications to or from an expansion card	37
Selecting copy settings	39
Using menus	39
Choosing application preferences	41
Performing common tasks	41
Creating records	41
Editing records	42
Deleting records	43
Purging records	44
Categorizing records	45
Finding information	48
Sorting lists of records	53
Attaching notes	54
Choosing fonts	55
Receiving alerts	56
Hiding or masking private records	57
Installing and removing applications	57
Installing add-on applications	57
Removing applications	61
Removing Palm Desktop software	61
Chapter 5: Using Address Book	63
Creating an Address Book entry	64
Selecting types of phone numbers	65
Changing Address Entry details	66
Making connections from Address Book	66
Quick Connect	66
Tap-to-Connect	68

Address Book menus	69
Record menus	69
Options menus	69
Chapter 6: Using Calculator	71
Performing calculations	71
Viewing recent calculations	72
Using Calculator menus	73
Chapter 7: Using Card Info	75
Reviewing Card Information	75
Renaming a card	76
Formatting a card	76
Managing an expansion card	77
Using the Card Info menu	77
Chapter 8: Using Date Book	79
Scheduling an event	80
Selecting an event	83
Rescheduling an event	83
Setting an alarm for an event	83
Scheduling repeating or continuous events	85
Changing repeating or continuous events	85
Considerations for repeating or continuous events	86
Changing the Date Book view	87
Working in Week view	87
Working in Month view	88
Working in Agenda view	89
Spotting event conflicts	90
Date Book menus, preferences, and display options	90
Record menu	90
Options menu	91
Chapter 9: Using Expense	93
Adding expense items	94
Changing the date of an Expense item	95
Entering receipt details	95
Customizing the Currency pick list	96
Changing the default currency	97
Defining a custom currency symbol	97

Setting Show Options	98
Working with Expense data on your computer	99
Displaying the euro on your computer	99
Printing the euro	99
Using Expense menus	100
Record menu	100
Options menu	100
Chapter 10: Using Memo Pad	101
Creating memos	101
Reviewing memos	102
Using Memo Pad menus	102
Record menus	103
Options menus	103
Chapter 11: Using Palm™ Mobile	105
Using your hands-free headset	106
Opening Palm Mobile	108
Answering a phone call	109
Dialing a number from the keypad	110
Redialing the most recently dialed number	110
Managing a phone call	111
Answering call waiting	112
Using conference calling	113
Creating a conference call	113
Managing a conference call	114
Retrieving voicemail	117
Using speed dial	118
Creating a speed-dial entry	118
Dialing a speed-dial entry	119
Editing a speed-dial entry	120
Using the Call History list	122
Dialing a number from the Call History list	122
Using redial reminders	123
Creating a redial reminder	123
Managing redial reminders	124
Managing profiles	124
Managing ring tunes	126
Using Palm Mobile menus	128

Mobile menu	128
Options menu	128
Chapter 12: Using Note Pad	131
Creating a note	132
Reviewing notes	132
Changing Note Pad color settings	133
Setting an alarm for a note	134
Using Note Pad menus	135
Record menu	135
Options menus	136
Chapter 13: Using SIM Manager	137
Adding SIM Manager items	138
Managing SIM Manager items	138
Using SIM Manager menus	139
Record menu	139
Options menu	139
Chapter 14: Using SIM Services	141
Accessing a service	142
Using the SIM Services menu	142
Options menu	142
Chapter 15: Using SMS	143
Creating messages	144
Sending and receiving messages	146
Viewing messages	147
Working with draft messages	149
Adding a signature to a message	150
Sending data from another application	151
Setting preferences	152
Using SMS menus	154
Message menu	154
Options menu	154
Chapter 16: Using To Do List	155
Creating list items	156
Setting priority	156
Checking off a To Do List item	157
Changing To Do List item details	158

Setting a due date	158
Setting To Do Preferences	159
Using To Do List menus	160
Record menu	160
Options menu	160
Chapter 17: Using Palm™ VersaMail™ Personal E-mail Software	161
Getting started with the VersaMail application	162
Synchronizing an existing username	162
Upgrading a MultiMail database	162
Installing Documents To Go	162
Setting up and managing e-mail accounts	163
Account and connection types	163
Setting up the default account that came with your handheld	163
Setting up a new e-mail account	164
Setting up a network e-mail account	165
Creating a network e-mail account	166
Creating a synchronize-only account	171
Setting VersaMail connection preferences	177
Editing e-mail accounts	178
Deleting an e-mail account	183
Selecting a different service for a given e-mail account	184
Getting, sending, and managing e-mail	186
Getting and reading e-mail	186
Creating and sending new e-mail	195
Working with attachments	204
Deleting messages	211
Emptying the trash	214
Marking messages as read or unread	215
Setting preferences for getting and deleting e-mail	217
Adding or updating an Address Book entry directly from a message ..	218
Synchronizing e-mail between the handheld and the desktop	219
Configuring an account in HotSync Manager	219
Setting synchronization options and account settings	220
Converting attached files	226
Synchronizing an account	228
Going beyond the basics	229
Setting server options for an IMAP account	229
Managing mail filters	230

Managing mail settings	234
Adding APOP to an account	241
Adding ESMTP to an account	242
Copying text from an e-mail message for use in other applications	244
Using the command bar	244
E-mail header details	245
Backing up mail databases	246
Wireless IMAP folder synchronization	247
Accessing corporate e-mail	248
Five-way navigation in the VersaMail application	248
Keyboard shortcuts in the VersaMail application	250
Chapter 18: Using Palm™ WAP Browser	253
Opening Palm WAP Browser	253
Opening a WAP site	254
Browsing a WAP site	255
Browsing secure WAP sites	256
Using bookmarks	257
Adding a bookmark	258
Visiting a bookmarked WAP site	259
Editing a bookmark	259
Deleting a bookmark	260
Using your Push Inbox	261
Using advanced features	262
Changing gateways	262
Setting advanced options	263
Using cache memory	263
Selecting an Access Point Name	264
Selecting Mode	265
Using the security features	266
Creating password and signature key pairs	266
Changing your password or signature	268
Viewing the public key and the signed key	270
Storing certificates	271
Viewing certificates	273
Using Palm WAP Browser menus	274
Go menu	274
Options menu	274

Chapter 19: Using World Clock	275
Setting the primary location	275
Choosing a different primary location	277
Setting the secondary locations	278
Adding a location	278
Modifying a Location	280
Removing a location	280
Setting an alarm	281
Using World Clock menus	282
Chapter 20: Performing HotSync® Operations	283
Selecting HotSync setup options	283
Customizing HotSync application settings	285
Performing cradle/cable HotSync operations	287
Performing a cradle/cable HotSync operation: Windows computer ...	287
Performing a direct HotSync operation: Mac computer	289
Conducting IR HotSync operations	292
Preparing your computer for infrared communication	292
Performing an IR HotSync operation	294
Returning to cradle/cable HotSync operations	295
Conducting HotSync operations using an attached modem	296
Preparing your computer for a modem HotSync operation	296
Preparing your handheld for a modem HotSync operation	298
Selecting the conduits for a modem HotSync operation	300
Performing a HotSync operation using an attached modem	300
Conducting network HotSync operations	301
Connecting to your company's dial-in server	301
Performing a network HotSync operation	304
Using File Link	304
Creating a user profile	305
Performing the first HotSync operation with a user profile	306
Chapter 21: Setting Preferences for Your Handheld	309
Viewing Preferences	310
Buttons preferences	310
Connection preferences	311
Creating and editing GPRS connections	312
Creating and editing GSM connections	315
IR to PC connection	316

Date and Time preferences	317
Digitizer preferences	318
Formats preferences	319
Country default	319
Time, date, week start, and numbers formats	319
General preferences	320
Auto-off delay	320
Cradle settings	320
System, alarm, and game sounds	321
Alarm Vibrate and indicator light settings	321
Beam Receive	321
Keyboard Preferences	322
Remapping keys	323
Mobile preferences	324
Turning the mobile radio on and off	324
Enabling call waiting	324
Concealing your number	325
Diverting your calls	326
Tracking your phone time	330
Checking your current status	331
Checking your GPRS network usage	332
Setting your network selection search mode	333
Viewing and editing your preferred networks list	334
Setting PIN for mobile power on	337
Unlocking your SIM card	339
Setting call barring	340
Setting Fixed Number Dialing (FND)	342
Network preferences	346
Modem Accessory and TCP/IP software	346
Selecting a service	347
Entering a password	348
Selecting a connection	349
Adding telephone settings	349
Entering a prefix	350
Disabling call waiting	350
Using a calling card	351
Connecting to your service	351
Creating additional service templates	352
Adding detailed information to a service template	352

Idle timeout	353
Selecting Next Service	353
Defining primary and secondary DNS	353
IP address	354
Login scripts	355
Creating a login script on your handheld	356
Plug-in applications	357
Deleting a service template	357
Network preferences menu commands	358
Owner preferences	358
Security preferences	359
Assigning a password	360
Locking your handheld	361
Recovering from a forgotten password	364
Making records private	365
ShortCuts preferences	367
Appendix A: Maintaining Your Handheld	369
Caring for your handheld	369
Battery considerations	370
Resetting your handheld	370
Performing a soft reset	371
Performing a hard reset	371
Installing and removing the SIM card	374
Appendix B: Frequently Asked Questions	377
Software installation problems	378
Operating problems	379
Tapping and writing problems	380
Wireless problems	381
Palm WAP Browser problems	383
SMS problems	384
Palm Mobile problems	384
Application problems	384
HotSync problems	386
Beaming problems	391
Recharging problems	391
Password problems	392
Technical support	392

Product Regulatory and Safety Information 395

Index 399

About This Book

This handbook is designed to help you get up and running quickly on your Palm™ Tungsten™ W handheld. It describes all you need to know about how to use your handheld and the applications that come with it. It describes:

- Enabling wireless features
- Making and receiving mobile phone calls
- Sending and receiving SMS messages
- Locating all the parts of your handheld
- Viewing and entering data
- Working with expansion cards
- Using your handheld with your computer
- Personalizing your handheld with your own preference settings

After you become familiar with the basic functionality of your handheld, you can use the rest of this handbook as a reference for performing less common tasks, for maintaining your handheld, and for solving problems that might arise as you operate your handheld.

Welcome

Your new Palm™ Tungsten™ W handheld is wirelessly enabled so that you can use it to transmit and receive information over the airwaves. Use your handheld to do the following:

- Send SMS (Short Message Service) messages.
- Read, compose, and send e-mail on-the-go.
- Browse or search the Internet.
- Make or receive a phone call.
- Stay organized and on time by keeping your appointments, contact information, and to-do items in one place.
- Quickly jot memos on the fly.

Before you can use these features, you must set up your handheld and install software on your desktop computer. To use your wireless features, you must install an activated SIM (subscriber identity module) card in your handheld.

Your handheld comes with an easy-to-follow installation guide, *Getting Started*, that steps you through the process of successfully setting up your handheld. The guide contains important information that must be followed for initial setup of the features available on your handheld.

IMPORTANT If you are upgrading from another Palm OS® handheld, see www.palm.com/support/tungstenw for important upgrade instructions before beginning your Tungsten W handheld installation.

System requirements

Before you install and operate Palm™ Desktop software, your computer system must meet the following minimum requirements.

Minimum requirements: Windows computers

The minimum requirements for Windows computers are as follows:

- IBM-compatible Pentium-class computer
- One of the following operating systems:
 - Windows 95 with SR2 or later and Winsock2 update (requires a serial cradle/cable, sold separately)
 - Windows NT 4.0 Workstation with SP6 or later (requires a serial cradle/cable, sold separately, and administrator rights to install Palm Desktop software)
 - Windows 98
 - Windows ME
 - Windows 2000 Pro (requires administrator rights to install Palm Desktop software)
 - Windows XP Home or Pro (requires administrator rights to install Palm Desktop software)
- Internet Explorer 4.01 with SP2 or later
- 50 megabytes (MB) available hard disk space
- VGA monitor or better (16 Bit or High Color, and 800 x 600 resolution recommended)
- CD-ROM or DVD-ROM drive (you can also download Palm Desktop software from www.palm.com/support/intl)
- Mouse
- One available USB port or serial port (serial cradle/cable sold separately)

Minimum requirements: Mac computers

The minimum requirements for Mac computers are as follows:

- Mac computer or compatible with a PowerPC processor
- Mac OS
 - Mac OS 9, version 9.0 or later
 - Mac OS X, version 10.1.2 or later
- 25MB available hard disk space

- 12MB available RAM
- Monitor that supports screen resolution of 800 x 600 or better
- CD-ROM or DVD-ROM drive (you can also download Palm Desktop software from www.palm.com/support/intl)
- Mouse
- One available USB port or serial port (serial cradle/cable sold separately and compatible with Mac OS 9 only)

Wireless service

IMPORTANT Whenever you use the wireless features of your handheld, please observe the guidelines or prohibitions on the use of wireless devices in your current location. For example, when you are on an airplane, do not turn on your radio at times when government or airline regulations prohibit the use of cellular phones. You can, of course, use all other applications of your handheld in accordance with airline regulations for electronic devices.

Your handheld is equipped with a GSM/GPRS mobile radio, so you can transmit and receive information over the airwaves, wirelessly, from your handheld. You don't need to plug a wire into a wall socket, and you don't need a modem.

After you charge the battery in your handheld, the mobile radio is ready for use. Follow the instructions in the *Getting Started* installation guide and this book to successfully set up and use your wireless features.

IMPORTANT Read your wireless service provider's documentation to understand the features and options you have selected as part of your service contract with your wireless service provider. This handbook describes a wide range of wireless features that are usable only if the service is provided by your wireless service provider.

Your handheld has a signal strength indicator to inform you of the availability and strength of wireless service in your immediate area. It also has an indicator showing your GPRS coverage. If you are having problems with your wireless coverage, see [“Wireless problems”](#) in [Appendix B](#).

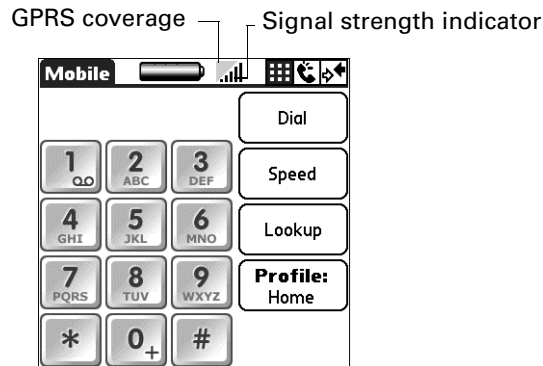

Making a call in a medical or safety emergency

To make a call for emergency service: Press all four application buttons at once. You can make this call even without the SIM card installed, so long as your handheld's radio is on and you are in an area that has coverage. The call is free.

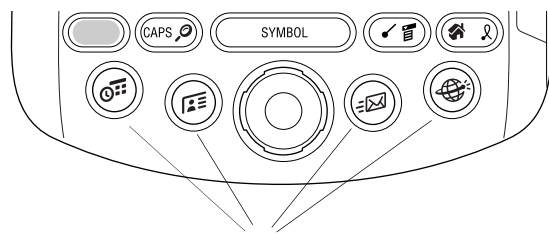

Press the four application buttons at once to make a call for emergency

Software Download Available

Palm Desktop software is supplied on a CD-ROM disc. Check www.palm.com/support/intl for updates and new versions of the software.

Compatibility of third-party applications

Palm works with developers of third-party add-on applications to ensure the compatibility of these applications with your new Palm handheld. Some third-party applications, however, may not have been upgraded to be compatible with your new Palm handheld, or they may not have been designed to incorporate all the features available in your handheld.

If you suspect that a third-party application is adversely affecting the operation of your handheld, contact the developer of the application. In addition, Palm has information about some applications' compatibility with your handheld. To find this information, do one of the following:

- Open your web browser and go to www.palm.com/support/tungstenw. On that page, click the link leading to information on the compatibility of third-party applications.
- Read the readme file for your handheld. After you install Palm Desktop software on your computer, open the Palm folder. The readme file is located in the Helpnote folder.

Finding information

For installation information, see *Getting Started* that came with your Tungsten W handheld. For comprehensive information about using your handheld, continue reading this electronic handbook.

For support information, upgrade information, articles, and answers to questions, see www.palm.com/support/tungstenw.

For more information about using Palm Desktop software, see the following:

- The handheld tutorial, Quick Tour. To access this tutorial, tap the Quick Tour icon from the Applications main screen.
- The Windows tutorial for Palm Desktop software, Desktop Quick Tour. To access this tutorial, open Palm Desktop software and select Quick Tour from the Help menu.
- The electronic *Palm Desktop software for the Macintosh User's Guide*. To access this guide, open the Palm folder and then open the Documentation folder. Double-click the file Palm Desktop.pdf.
- The online help for Palm Desktop software. To access the online help, open Palm Desktop software and select the Help menu.

Exploring Your Handheld

Your wirelessly enabled Palm™ Tungsten™ W handheld helps you stay in touch with important information while you are away from your desk. You can stay organized, on time, and up-to-date with daily tasks. Use your new handheld to do the following:

- Compose and securely send and receive business or personal e-mail wirelessly.

NOTE Some companies restrict access to internal e-mail accounts when using a handheld. Check your company for their policy on use of handhelds.

- Receive alerts when a new voicemail or SMS message arrives or a reminder occurs. Rely on any or all of the three alert modes: the indicator light, vibrator, or alarm sound. Support for the alert feature depends on your contract with your wireless service provider.
- Access WAP content, applications, and games.
- Make phone calls using a hands-free headset.
- Set preferences for how you receive alarms: hearing a sound, seeing a blinking indicator light, or feeling your handheld vibrate. Choose any combination.
- Access Internet information.
- Browse or search the Internet.
- Download and use web clipping applications that help you find specially formatted Internet information quickly.

NOTE Using web clipping on the handheld requires software that is available on the Software Essentials CD.

- Enter your schedule in Date Book.
- Keep all your contact names, addresses, and phone numbers in Address Book.
- Prioritize and assign your tasks a due date in To Do List.
- Set alarms from World Clock and Date Book to keep yourself on schedule and remind yourself of appointments, redial reminders, and notes.
- Synchronize your data with Palm™ Desktop software on your Windows or Mac computer so you can work with your personal information on your computer and maintain a copy of your information.

- Insert SD or MultiMediaCard expansion cards to add more software or memory, or to back up your data.
- Beam information to another device that has an infrared (IR) port.

Locating handheld components

Take a few moments to locate the front and back panel components of your handheld.

Locating front panel controls

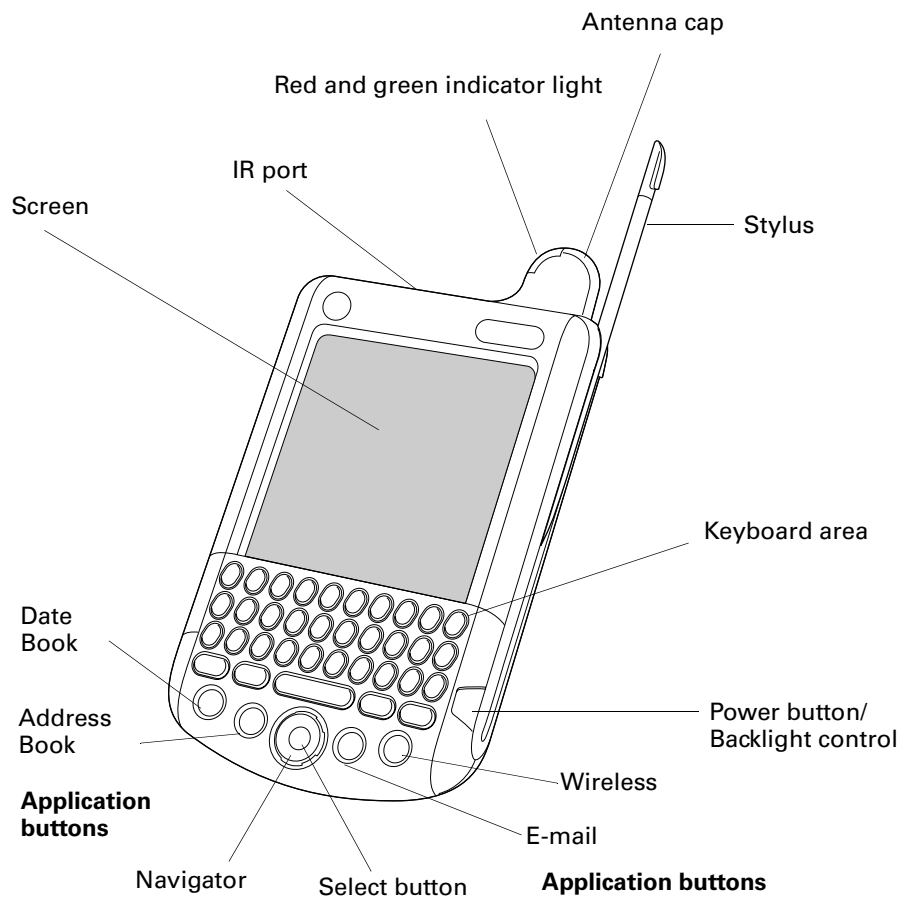

IR port	Uses infrared technology to transmit data to and receive data from other Palm OS® handhelds, and to perform HotSync® operations. See “Using elements of the handheld interface” in Chapter 3 and see “Conducting IR HotSync operations” in Chapter 20 for more information.
Red and green indicator light	Indicates when you are within or out of range for wireless transmission. It also notifies you of incoming Date Book or World Clock alarms.
Antenna cap	Houses the antenna for your mobile radio.
Stylus	Slides in and out of the slot in the side channel of the handheld. To use the stylus, remove it from the slot and hold it as you would a pen or pencil. Unscrew the top of the stylus to access the reset tool.
Keypad	The area where you type letters and numbers, and access special function keys. See Chapter 3 to learn how to type characters.
Power button/ Backlight control	<p>Turns your handheld on or off and controls the backlight feature. If your handheld is turned off, pressing the power button turns the handheld on and returns you to the last screen you viewed.</p> <p>If your handheld is turned on, pressing the power button turns the unit off.</p> <p>Pressing the power button for about two seconds turns the backlight on or off. For more information on the backlight, see the next section, “Using the indicator light”.</p>
Application buttons	Activate the individual handheld applications that correspond to the icons on the buttons: Date Book, Address Book, E-mail, and Wireless. See “Buttons preferences” in Chapter 21 for details on reassigning these buttons to open any application on your handheld.
Navigator	The five-way navigation button enables you to move up, down, right, and left in pick lists and menus. You can scroll down to view information below the viewing area, and scroll up to view the information above the viewing area. The navigator also has some special functions that are described in this handbook.

Select button	The navigator center Select button enables you to select items. The Select button also has some special functions that are described in this handbook.
Screen	Displays the applications and information stored in your handheld. It is touch-sensitive and responds to the stylus.

Using the indicator light

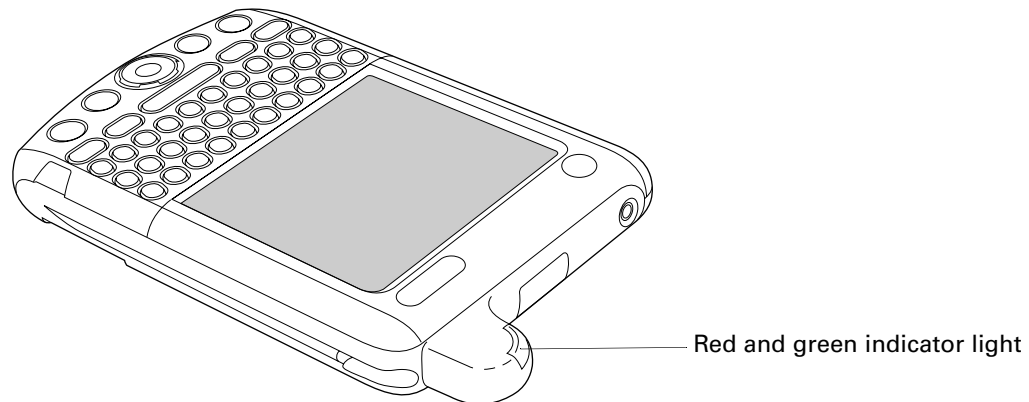

The indicator light at the top of the handheld blinks to indicate the following status levels:

No light	Mobile radio is off.
Green light flashes every five seconds	Mobile radio is on and transmitter is within range.
Red light flashes every five seconds	Mobile radio is on, but transmitter is out of range. You need to move to another area to bring the transmitter within range.
Green light flashes at paired intervals	A notification that: <ul style="list-style-type: none">■ Date Book or World Clock event alert has occurred.■ A call was missed.■ Voicemail was received. A dialog box appears, describing the reason for notification. Acknowledging the notification turns off the indicator light.

Locating back panel components

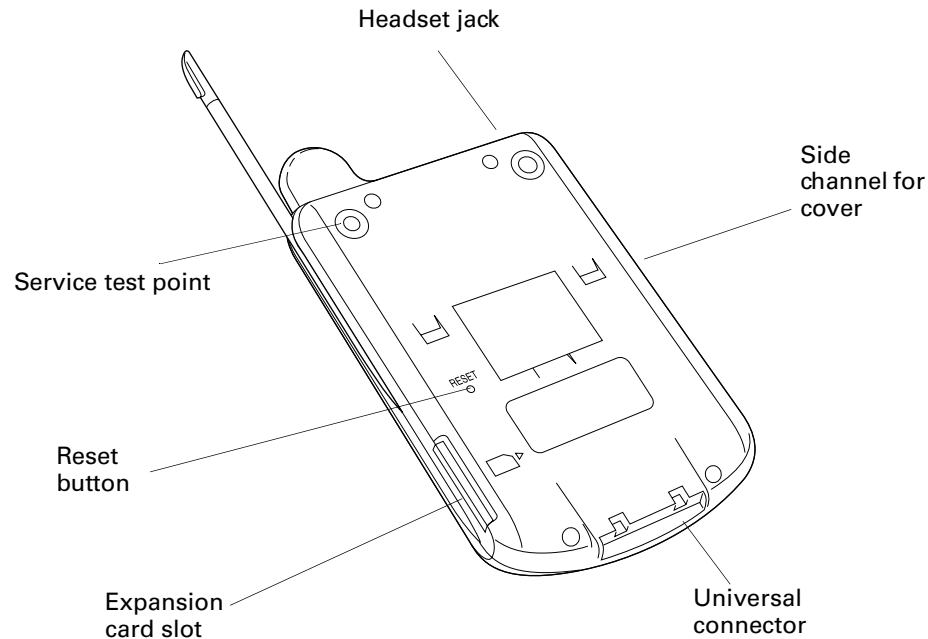

Headset jack	Connects the hands-free headset to your handheld, enabling you to make or receive telephone calls.
Service test point	For use by Palm, Inc., authorized service personnel only.
Reset button	Under normal use, you should not have to use the reset button. See “Resetting your handheld” in Appendix A for information about when and how to use the reset button.
Expansion card slot	Accepts SD or MultiMediaCard expansion cards, enabling you to add more memory, applications, or Bluetooth functionality. You can also back up data to an expansion card.
	NOTE Expansion cards are purchased separately.
Universal connector	Connects your handheld to the cradle, which in turn connects to the back of your computer and through the AC adapter to the wall current. This allows you to recharge your handheld as well as update the information between your handheld and computer using HotSync technology. The universal connector also connects peripheral hardware devices to your handheld.
Side channel	The left side channel holds the front cover, which slides in and out.

Adding an expansion card

A tiny expansion card (sold separately) increases the variety of tasks you can do and the amount of space you have for storing software and data on your handheld.

To insert a card:

1. Insert the card in the direction shown by the icon.
2. Push the card in with your thumb. You feel the card lock and hear the system sound.

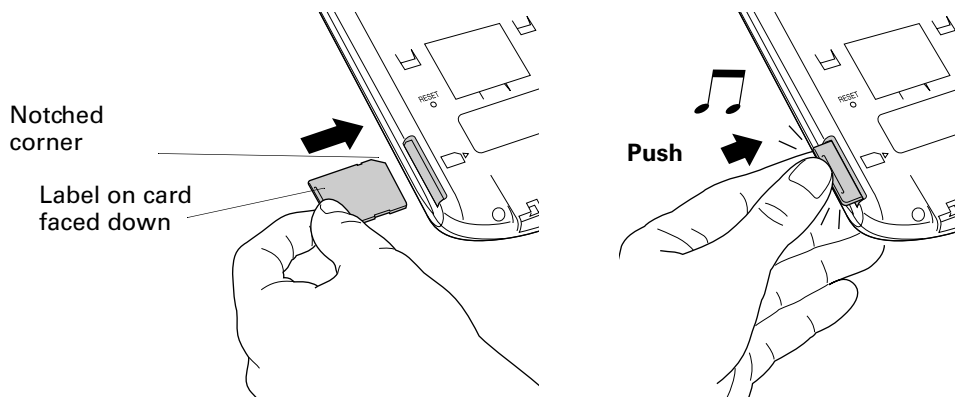

To remove a card:

1. Push lightly against the card with your thumb.
2. When the card is released, you hear the system sound.

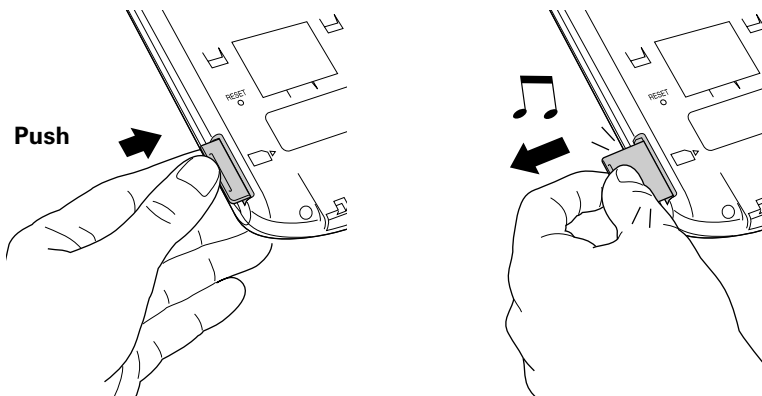



For complete information about working with expansion cards, see [Chapter 7](#).

Using the backlight

The backlight makes it easy for you to see the information on your handheld. The backlight is on by default but can be turned off to extend battery life. You can turn on, off, or adjust the backlight in the following ways:

- Turn off the backlight and power automatically (after a period of inactivity) with the Auto-off feature. See “[General preferences](#)” in [Chapter 21](#) for more information.
- Turn the backlight on or off by pressing the power button and holding it down for about two seconds. Release the button when the backlight turns on or off.
- Disable the backlight or adjust the backlight brightness level using the Adjust Brightness dialog box.

To enable the backlight or adjust the backlight level:

1. Press Function  + Brightness .
2. Tap the Enable Backlight check box to select it.
3. Tap to the left or right of the slider to adjust the brightness in small increments, or drag the slider to change the brightness in large increments.

Navigating and Entering Data

This chapter explains how to enter data into your handheld, navigate around the interface, and use menu commands. There are several ways to enter data, to navigate, and to use menu commands:

- Tapping
- Using the five-way navigator
- Using the handheld keyboard
- Beaming data from another device that has an infrared port
- Entering or importing data in Palm™ Desktop software and then synchronizing with your handheld

Tapping

Like using a mouse to click elements on a computer screen, using the stylus to tap elements on your handheld screen is the basic action that gets things done on your handheld.

The first time you start your handheld, setup instructions appear on the screen. These instructions include a calibration screen. Calibration aligns the internal circuitry of your handheld with its touch-sensitive screen so that when you tap an element on the screen, the handheld can detect exactly which task you want to perform.

IMPORTANT Always use the point of the stylus for tapping or making strokes on the handheld screen. Never use an actual pen, pencil, or other sharp object to write on the handheld screen.

With your handheld turned on, you can tap the handheld screen to do many operations, such as the following:

- Open applications
- Choose menu commands
- Select options in dialog boxes

Just as you can drag the mouse to select text or move objects on your computer, you can also drag the stylus to select text. You can also use the stylus to drag the slider of any scroll bar.

Using the navigator

When you work with most applications, the navigator on the front panel of your handheld makes it easy for you to navigate among and select your entries. You can use the navigator to perform tasks without the stylus using one hand.

See [Chapter 4](#) and [Chapter 5](#) for additional information about using the navigator with Address Book, and [Chapter 8](#) for additional information on using the navigator with Date Book.

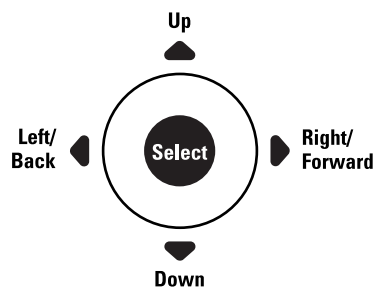

To navigate in list screens, do any of the following:

- Press Up or Down on the navigator to scroll an entire screen of records.
- Press and hold Up or Down on the navigator to accelerate the scrolling.
- Press Select on the navigator to insert the selection highlight. When the selection highlight is present, you can do the following:
 - Press Up or Down on the navigator to scroll to the previous or next records.
 - Press Select again to view the selected record.
 - Press Left on the navigator to remove the selection highlight.

To navigate in record screens:

1. Press Up or Down on the navigator to scroll within the current record.
2. Press Right or Left on the navigator to scroll to the previous or next record. (This feature is not available in Address Book.)
3. Press Select on the navigator to return to the list screen.

To navigate in dialog boxes:

- While a pick list is open, press Up or Down on the navigator to highlight an item, and then press Select on the navigator to select the item.
- Press Select on the navigator to close a dialog. If there's only one button, pressing Select activates that button. If there's multiple buttons, Select activates affirming buttons such as OK, Yes, or Done.

IMPORTANT Read dialog boxes carefully. Sometimes, selecting OK or Yes results in deleting data.

Using the keyboard

You can quickly and accurately enter text or numbers on your handheld using the keyboard. The keyboard also has special function keys that enable you to access features. Another feature is AutoCorrect, which automatically corrects some common misspellings when entering data from the keyboard.

Below the keyboard are application buttons and the 5-way navigator that enables you to navigate menus and pick lists quickly without using the stylus. These features are described in [Chapter 2](#).

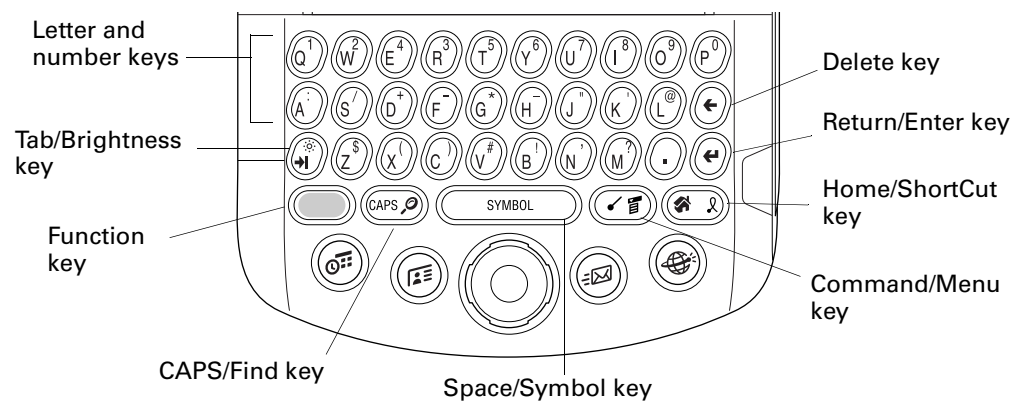







Letter and number keys: Enables you to enter letters and numbers. You can change the key response from the Keyboard preferences screen. See [“Keyboard Preferences”](#) in [Chapter 21](#).

You can also access international characters using the navigator control. See [“Accessing international and special characters”](#) later in this chapter.



Tab/Brightness key: Adds a tab or opens the Brightness dialog box. For more information on the Brightness dialog box, see [“Using the indicator light”](#) in [Chapter 2](#).

-  **Function key:** Press to access the secondary character set. See “Using the Function key” later in this chapter.
-  **CAPS/Find key:** Capitalizes letters or opens the Find dialog box. For more information on capitalizing letters, see the next section “Typing capital letters”. For information on the Find dialog box, see “Finding information” in Chapter 4.
-  **Space/Symbol key:** Adds a space to the text or opens the onscreen keyboards. For more information about the onscreen keyboards, see “Accessing the onscreen keyboards” later in this chapter.
-  **Command/Menu key:** Opens the Command toolbar or Menu. For information about the Command mode, see “Menu commands” in Chapter 4. For more information about Menus, see “Using menus” in Chapter 4.
-  **Home/ShortCut key:** Opens the Application Launcher or enables you to enter a text ShortCut. For more information on ShortCuts, see “Using ShortCuts” later in this chapter.
-  **Return/Enter key:** Adds a manual return to the next line or enters the data.
-  **Delete/Backspace key:** Deletes the previous character.

Typing capital letters

The keyboard enables you to capitalize letters in two ways:

- Use the CAPS key . Press the CAPS key twice to initiate CAPS lock.
- Press and hold the key. This feature works only when the Keyboard preference Repeat Function is set to Capital. See “Keyboard Preferences” in Chapter 21 for more information.

Accessing international and special characters

You can access international and special characters directly from the keyboard or from onscreen keyboards. These character sets enable you to communicate accurately through your memos or wireless messages.

Accessing from the keyboard

You can access international characters from the keyboard by pressing and holding a key, and then pressing Up and Down on the navigator. The character on the screen scrolls through a sequence of related international characters. You can scroll though the sequence either forward or backward depending on whether you are pressing Up or Down on the navigator.



NOTE This feature does not work with every key or with the Function key secondary character set.

To access international characters from the keyboard:

1. Press and hold a key.
2. Press Up or Down on the navigator.
3. Accessing the onscreen keyboards

You can open the onscreen keyboards anytime you need to enter special characters or numbers on your handheld.

To use the onscreen keyboard:

1. Open any application (such as Memo Pad).
2. Tap any record, or tap New.
3. Press Function  + Symbol .

When a keyboard is open, you can tap to open any of the other keyboards.

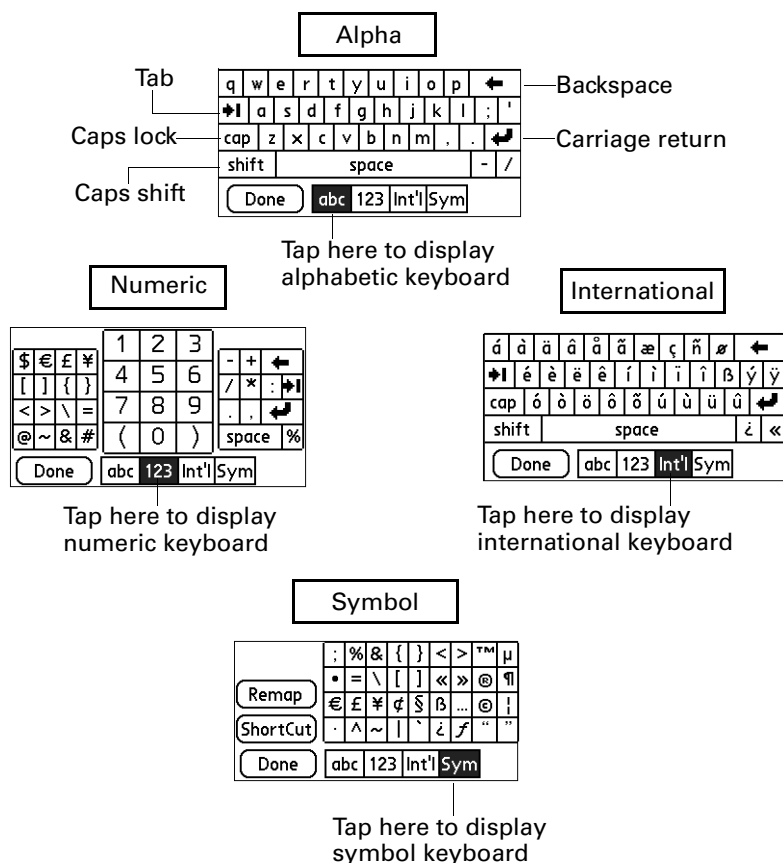



After you finish, tap Done to close the onscreen keyboard and place the text in the record.

Using the Function key

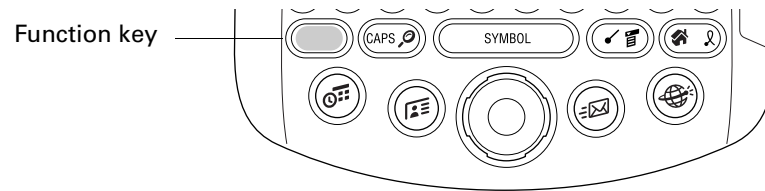
The Function key  enables you to access the secondary character or feature set from each of the keys. The secondary character and feature set is labeled in blue in the upper right on each available key.



When you press Function , a dot appears in the lower-right corner, indicating that the next key pressed will use the secondary character or feature set. If you press the Function  twice, the dot changes to a “1” and the function feature remains locked. Pressing Function  again unlocks it.



Function active icon



Function lock icon

Using special features

In addition to characters, the Function key accesses special features on some of the keys. The following keys have special features:



Brightness key: Opens the Brightness dialog box. See “Using the backlight” in Chapter 2 for more information.



Find key: Opens the Find dialog box. See “Using Find” in Chapter 4 for more information.



Menu key: Opens the menu for the current screen. For more information, see “Using menus” in Chapter 4 and see the next section, “Using menu commands”.

Using menu commands

By using the menu commands you can access many functions directly from the keyboard without tapping.

Most menu commands have an equivalent Command stroke, which is similar to the keyboard shortcuts used to execute commands on computers. The command letters appear to the right of the command names. For example, to choose Select All in the Edit menu, press Command stroke (⌘), and type the letter s.



The command toolbar displays context-sensitive menu commands for the current screen. For example, if text is selected the menu icons displayed may be Undo, Cut, Copy, and Paste. Tap an icon to select the command.

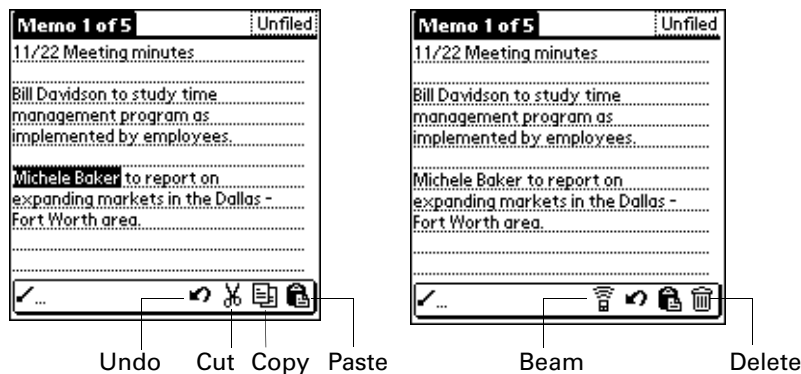

To use menu commands:

1. Press Command stroke (⌘).

The Command toolbar opens at the bottom of the screen. The Command toolbar indicates that you are in Command mode.

2. Tap an icon or type the command letter immediately to choose the menu command.

Command mode is active only for a short time.

Using ShortCuts

ShortCuts make entering commonly used words or phrases quick and easy. ShortCuts are similar to the Glossary or Autotext features of some word processors.

The handheld comes with several predefined ShortCuts, and you can also create your own. Each ShortCut can represent up to 45 characters. For example, you might create a ShortCut for your name or for the header of a memo. See “[ShortCuts preferences](#)” in [Chapter 21](#) to learn about creating your own ShortCuts.

To use a ShortCut:

1. Press Function  + ShortCut .

When you press the ShortCut key, the ShortCut symbol appears at the insertion point to show that you are in ShortCut mode.

2. Type the ShortCut characters.

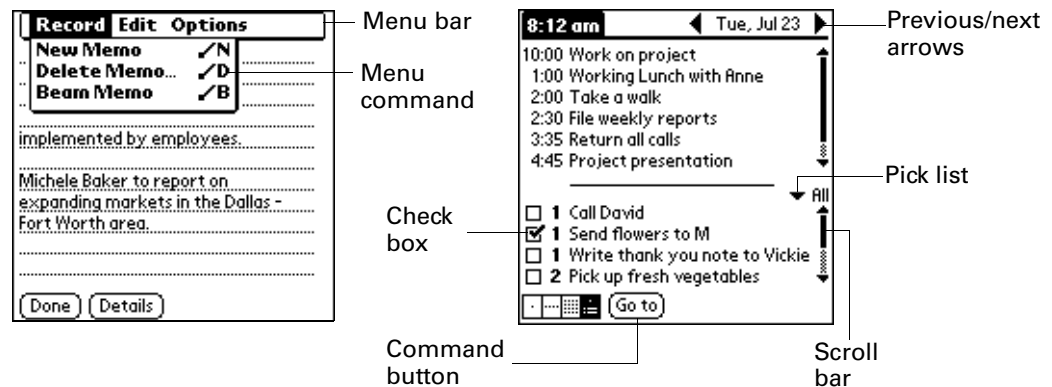

Using elements of the handheld interface



Menu bar and menu commands





A set of commands that are specific to the application. Not all applications have a menu bar.

To access the menu bar, do one of the following:

- Tap the Menu bar.
- Press Function  + Menu .

To access the menu commands, do one of the following:

- Tap the menu command on the menu.
- Use Right, Left, Up, or Down on the navigator.
- Press Command Stroke  + the letter. For more information see “[Using menu commands](#)” later in this chapter.

- Check box** When a checkmark appears in a check box, the corresponding option is active.
- To insert or remove a check mark:
- If a check box is empty, tapping it inserts a checkmark.
 - If a check box is selected, tapping it removes the checkmark.
- Command buttons** These appear in dialog boxes and at the bottom of application screens.
- To select a command button, do one of the following:
- Tap a button to perform a command.
 - Press Select on the navigator to select buttons such as OK, Yes, or Done.
 - Press Function  + Enter  to select the OK, Done, or Yes buttons.
 - Press Function  + Backspace , to select Cancel or No buttons.
- Next/previous arrows** The left and right arrows display the previous and next record; the up and down arrows display the previous and next page of information.
- To use the arrows, do one of the following:
- Tap the arrows.
 - Use Right, Left, Up, or Down on the navigator.
- Pick list** A list of choices that you can select from.
- To use the pick list:
- Tap the arrow to display a list of choices.
 - Tap an item in the list.
 - Use Up or Down on the navigator to scroll through the list and select an item.

Scroll bar A bar that enables you to scroll up and down a page.

To use the scroll bars:

- Drag the slider, or tap the top or bottom arrow, to scroll the display one line at a time.
- To scroll to the previous page, tap the scroll bar just above the slider. To scroll to the next page, tap the scroll bar just below the slider.
- You can also scroll to the previous and next pages by pressing Up and Down on the navigator.

Displaying online tips

Many of the dialog boxes that appear on your handheld contain an online Tips icon in the upper-right corner. Online tips anticipate questions you have in a dialog box, provide shortcuts for using the dialog box, or give you other useful information.

To display an online tip:

1. Tap the Tips icon ⓘ.
2. After you review the tip, tap Done.

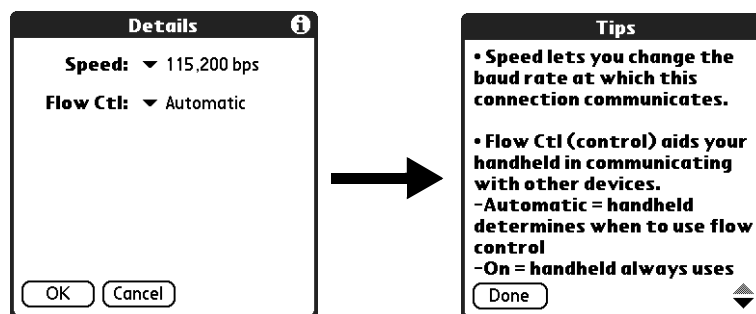

Beaming data



Your handheld is equipped with an infrared (IR) port that is located at the top of the handheld, behind the small dark shield. The IR port supports the IrCOMM implementation of the standards for infrared communication established by the Infrared Data Association (IrDA). This means that not only can you beam data to another Palm OS® handheld that's close by and equipped with an IR port, but you can also beam data to a mobile phone and to any other device that supports the IrCOMM implementation of the IrDA standards and that can read the type of data you're beaming.

You can beam the following information between devices with an IR port:



- The record currently displayed in Date Book, Address Book, To Do List, or Memo Pad
- All records of the category currently displayed in Address Book, To Do List, or Memo Pad
- A special Address Book record that you designate as your business card, containing information you want to exchange with business contacts
- An application installed in RAM memory
- An application installed on an expansion card that is seated in the card slot

TIP You can also perform HotSync® operations using the IR port. See “[Conducting IR HotSync operations](#)” in [Chapter 20](#) for details.

To select a business card:

1. Create an Address Book record that contains the information you want on your business card.
2. Press Function  + Menu .
3. Select “Select Business Card” on the Record menu.
4. Tap Yes.

To beam a record, business card, or category of records:

1. Locate the record, business card, or category you want to beam.
2. Press Function  + Menu .
3. Select one of the following from the Record menu:
 - The Beam command for an individual record
 - In Address Book only: Beam Business Card
 - Beam Category
4. When the Beam Status dialog box appears, point the IR port directly at the IR port of the receiving handheld.



For best results, handhelds should be between 10 centimeters (approximately 4 inches) and 1 meter (approximately 39 inches) apart, and the path between the two handhelds must be clear of obstacles. The beaming distance to other Palm OS handhelds may be different.



5. Wait for the Beam Status dialog box to indicate that the transfer is complete before you continue working on your handheld.

TIP You can also press and hold the Address Book application button to instantly beam your business card to another device with an IR port.

To beam an application:

1. Press the Home .
2. Press Function  + Menu .
3. Tap App, and then select Beam.
4. Select either Handheld or Card from the Beam From pick list.
5. Tap the application you want to transfer.

Some applications are copy-protected and cannot be beamed. These are listed with a lock icon next to them.

6. Tap Beam.
7. When the Beam Status dialog box appears, point the IR port directly at the IR port of the receiving handheld.
8. Wait for the Beam Status dialog box to indicate that the transfer is complete before you continue working on your handheld.

To receive beamed information:

1. Turn on your handheld.
2. Point the IR port directly at the IR port of the transmitting handheld to open the Beam dialog box.
3. Select a category for the incoming information, create a new category, or leave the information unfiled.



4. Tap Yes.

Using your computer keyboard

If you have a lot of data to enter, or prefer to use the computer keyboard, you can use Palm Desktop software or any supported personal information manager (PIM) to enter information. You can then perform a HotSync operation to synchronize the information on your computer with the information on your handheld. Many of the applications that came with your handheld are also available in Palm Desktop software and in most PIMs, so you don't need to learn different applications. For more information on entering data on your computer, refer to the online Help in Palm Desktop software, the Quick Tour in Palm Desktop software (for Windows users), and the Palm™ Desktop software Software for the Macintosh User's Guide on the Palm Desktop software CD-ROM.

Importing data

If you have data stored in computer applications such as spreadsheets and databases, or if you want to import data from another handheld, you can transfer the data to your handheld without having to enter it manually. Save the data in one of the file formats in the following list, import it into Palm Desktop software, and then perform a HotSync operation to transfer the data to your handheld.

Importing data from a Windows computer

Palm Desktop software can import data in the following file formats:

- Comma delimited (.csv, .txt): Address Book and Memo Pad only
- Tab delimited (.tab, .tsv, .txt): Address Book and Memo Pad only
- CSV (Lotus Organizer 2.x/97 Mapping): Address Book only
- vCal (.vcs): Date Book only
- vCard (.vcf): Address Book only
- Date Book archive (.dba)
- Address Book archive (.aba)
- To Do List archive (.tda)
- Memo Pad archive (.mpa)

Archive formats can be used only with Palm Desktop software. Use the archive file formats to share information with other people who use a Palm OS handheld or to create a copy of your important Palm Desktop information.

To import data from a Windows computer:

1. Open Palm Desktop software.
2. Click the application into which you want to import data.
3. If you are importing records that contain a field with category names, do the following:

Select All in the Category box.

Be sure that the same categories that appear in the imported file also exist in the application. If the categories do not exist, create them now; otherwise, the records are imported into the Unfiled category.

4. From the File menu, choose Import.
5. Select the file you want to import.
6. Click Open.

If you are importing a vCal or vCard file, skip to step 10. You do not have to specify which fields correspond to the imported data.

7. To import data into the correct Palm Desktop fields, drag fields in the left column so that they are opposite the corresponding imported fields on the right.
8. If you do not want to import a field, deselect the check box for that field.
9. Click OK.

The imported data is highlighted in the application.

10. To add the imported data to your handheld, perform a HotSync operation.

See Palm Desktop online Help for more information on importing and exporting data.

Using File Link

The File Link feature enables you to import Address Book and Memo Pad information to your handheld from a separate external file on your Windows computer, such as a company phone list. You can configure the File Link feature to check for changes to the external file when you perform a HotSync operation. HotSync Manager stores the data in a separate category in Palm Desktop software and on your handheld.

With File Link, you can import data stored in any of the following formats:

- Comma-separated (*.csv)
- Memo Pad archive (*.mpa)
- Address Book archive (*.aba)
- Text (*.txt)

For information on how to set up a file link, see the Palm Desktop online Help.

Importing data from a Mac computer

Palm Desktop software can import data from any of the following applications when you export the data in the appropriate file format:

- Address Book Plus (text file)
- Claris Organizer (Palm Desktop software can open these files directly).
- ClarisWorks (Save under new name as ASCII text file).
- DateBook Pro (text file)
- DayMaker (text file)
- Dynodex (text file)
- FileMaker Pro (tab separated text file)
- Meeting Maker (text file)
- Newton running OS 1.0 with Newton Connection Kit: Names, Date Book Calendar, and Notepad (text file)
- Now Contact (text file)
- Now Up-to-Date (text file)
- QuickDex (text file)
- TouchBase Pro (text file)

Palm Desktop software can also import data in the following file formats:

- Tab delimited (.tab, .tsv, .txt)
- vCal (.vcs): Data Book only
- vCard (.vcf): Address Book only

To import data from a Mac computer:

1. Open Palm Desktop software.
2. From the File menu, choose Import.
3. Select the file you want to import.
4. Click Import.
5. If you want to change the order of the fields you're importing, point to a field, wait for the cursor to change to a double arrow, and then drag the field to a new location.
6. If you do not want to import a field, click the arrow between the field names.
7. From the Fields pop-up menu, choose the appropriate field.

8. From the Delimiters pop-up menu, choose the appropriate delimiter.
9. Click OK.
10. To add the imported data to your handheld, perform a HotSync operation.

See Palm Desktop online Help for more information on importing and exporting data.

Working with Applications

This chapter explains how to open and switch between applications on your handheld, how to change application settings so they are personalized to your work methods, and how to categorize applications so you view them in related groups.

Opening applications

You can use the Applications Launcher to open any application installed on your handheld or on an expansion card. You can also open Date Book and Address Book with the application buttons on your handheld.

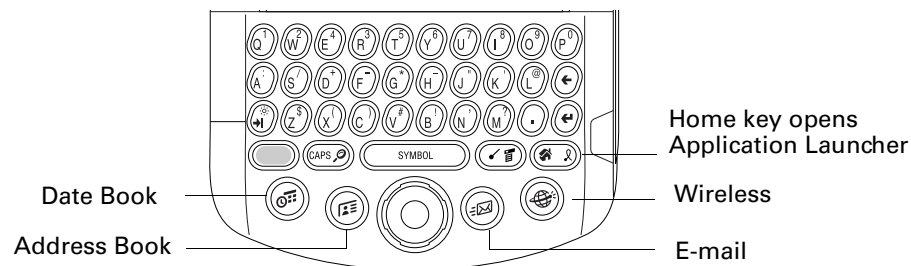

In addition to providing a way for you to open applications, the Applications Launcher displays the current time, battery level, and application category.

To open an application on your handheld:

1. Press Home (🏠).

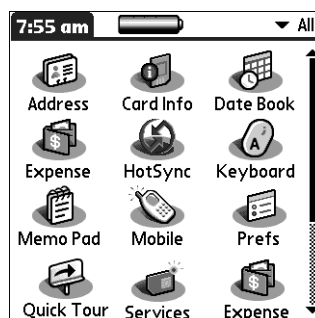

2. Tap the icon of the application that you want to open. If you have many applications installed on your handheld, tap the scroll bar to see all your applications.

Other ways to open applications

You can also open applications on your handheld in either of the following ways:

- Press and hold Select on the navigator to open the Applications Launcher. Press Select on the navigator to insert the highlight. Press Up, Down, Right, and Left on the navigator to highlight the icon of the application you want to open. Press Select on the navigator to open the application.
- In the Applications Launcher, type the first letter of the application's name. The Applications Launcher scrolls to the first application with a name that begins with that letter and highlights the icon. You can open the icon by pressing the Enter key.

Opening expansion card applications

When an expansion card is properly seated in the expansion card slot, your handheld responds based on the contents of the card and the application that is active when you insert the card. In some cases, the application on the card opens automatically upon insertion, or if you insert a card containing data from the current application, the application displays the data on the card. In other cases, the Applications Launcher switches to the card, and displays its contents, and the pick list in the upper-right corner of the screen displays the name of the card.

To open an application on an expansion card:

- Select the icon of the application that you want to open.

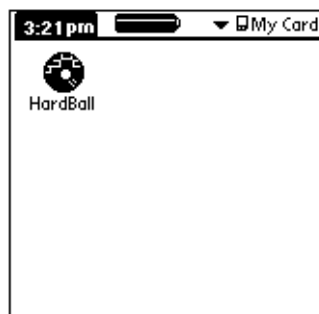

Switching between applications

When working with any application, press Home (⌘) or press an application button on your handheld to switch to another application. Your handheld automatically saves your work in the current application and displays it when you return to that application.

When you use an expansion card, your handheld creates and displays a new category that matches the name of the expansion card. You can easily switch between applications installed on your handheld and on the expansion card.

To switch to an expansion card:

1. Tap the pick list in the upper-right corner.

TIP When the highlight in the Applications Launcher is *not* active, you can also press and hold Select on the navigator to open the category pick list.

2. Select the category item that matches the name of the expansion card.

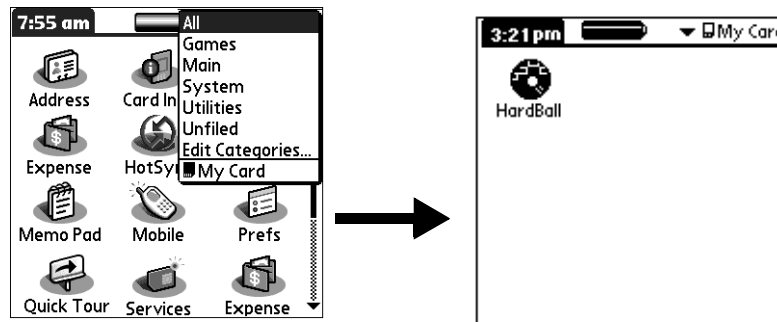

Categorizing applications

The category feature enables you to manage the number of application icons that appear onscreen in the Applications Launcher. You can assign an application to a category and then display a single category or all your applications.

By default, your handheld includes system-defined categories, such as All and Unfiled, and user-defined categories, such as Games, Main, and System.

You cannot modify the system-defined categories, but you can rename and delete the user-defined categories. In addition, you can create your own user-defined categories. You can have a maximum of 15 user-defined categories.

When you have an expansion card properly seated in the expansion card slot, the last item in the category pick list becomes the name of the expansion card. You cannot otherwise categorize applications that reside on an expansion card.



To categorize an application:

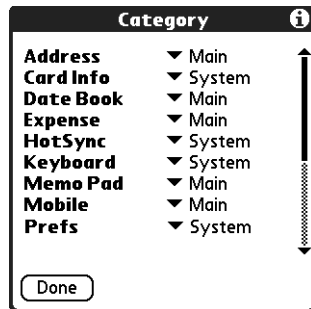

1. Press Home (🏠).
2. Press Command Stroke (⌘) + Y.

Alternately, press Function (F) + Menu (☰), and then select Category on the App menu.



3. Tap the pick list next to each application to select a category.



TIP To create a new category, select Edit Categories from the pick list. Tap New, enter the category name, and then press Function  + Enter , or tap OK to add the category.

4. Press Function  + Enter , or tap Done.

To display applications by category:

1. Press Home .
2. Do one of the following:
 - Press Home  repeatedly to cycle through all your categories.
 - Tap the pick list in the upper-right corner of the screen, and select the category you want to display.
 - When the highlight in the Applications Launcher is not active, press and hold Select on the navigator to open the category list, press Up or Down on the navigator to highlight a category, and then press Select on the navigator to display that category.



Changing the Applications Launcher display

By default, the Applications Launcher displays each application as an icon. As an alternative, you can choose to show a list of applications. You can also choose to view the same category of applications each time you open the Applications Launcher.

To change the Applications Launcher display:





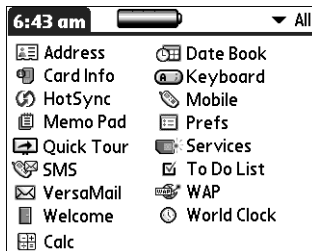

1. Press Home .
2. Press Command Stroke  + R.

Alternately, press Function  + Menu , select Options, and then select Preferences.

3. Tap the View By pick list and select List.
4. Press Function  + Enter , or tap OK.







To open the Applications Launcher to the last opened category:

1. Press Home .
2. Press Command Stroke  + R.
Alternately, press Function  + Menu , select Options, and then select Preferences.
3. Tap the Remember Last Category check box to select it.
4. Press Function  + Enter , or tap OK.

Copying applications to or from an expansion card

You can copy applications from your handheld to an expansion card, or from an expansion card to your handheld.

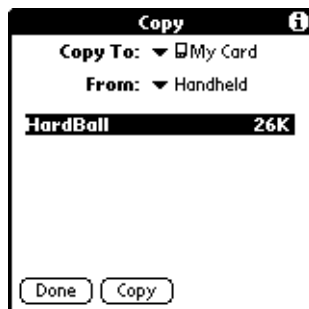

To copy an application to an expansion card:

1. Press Home .
2. Press Command Stroke  + C.
Alternately, press Function  + Menu , select Copy on the App menu.



3. Select Handheld from the Copy From pick list.
4. Select the card name from the Copy To pick list.

The Copy To pick list appears only if there are multiple cards available.



5. Tap an application to copy.
6. Tap Copy.
7. Press Function  + Enter , or tap Done.

You can install applications to a card that is seated in the expansion card slot during a HotSync® operation; see [“Installing add-on applications”](#) later in this chapter for details.



NOTE If you view your applications on the card using a Card Reader on your Windows or Mac computer, the actual file names may differ from those displayed in the Applications Launcher.

To copy an application from an expansion card:

1. Press Home .
2. Press Command Stroke  + C.

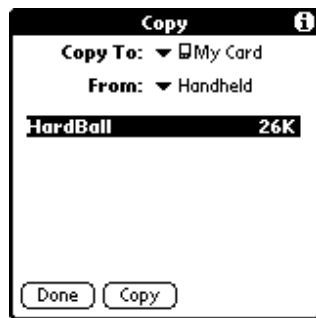
Alternately, press Function  + Menu , select Copy on the App menu.



3. Select the card name from the Copy From pick list.
4. Select Handheld from the Copy To pick list.
5. Tap an application to copy.
6. Tap Copy.
7. Press Function  + Enter , or tap Done.

You can also beam applications from expansion cards to your handheld. See [“Using elements of the handheld interface”](#) in [Chapter 3](#) for details.

Selecting copy settings

When using the copy feature, you can set the following:

- How applications are sorted and listed
- Whether to copy only the application or both the application and its data files

To select copy settings:

1. Press Home (⌂).

2. Press Command Stroke (⌘) + C.

Alternately, press Function (fn) + Menu (⌘), select Copy on the App menu.

3. Tap Settings.



4. Select Name or Size from the Sort By pick list.

5. Tap the Copy Application Only check box to select it, if you want to copy only the application files. Leave it deselected if you want to copy both the application file and its associated data files.

6. Press Function (fn) + Enter (↵), or tap OK.



NOTE The Sort By setting is in effect each time you use the copy feature. Each time you want to copy an application only, you must select the Copy Applications Only check box.

Using menus

Menus on your handheld are easy to use. Once you have mastered them in one application, you can use them the same way in all other applications.

The menus of each application are illustrated in the chapter that discusses that application.

To open the menu bar:

1. Open an application (such as Memo Pad).
2. Do one of the following:
 - Press Function  + Menu .
 - Tap the inverted title area at the top of the screen.

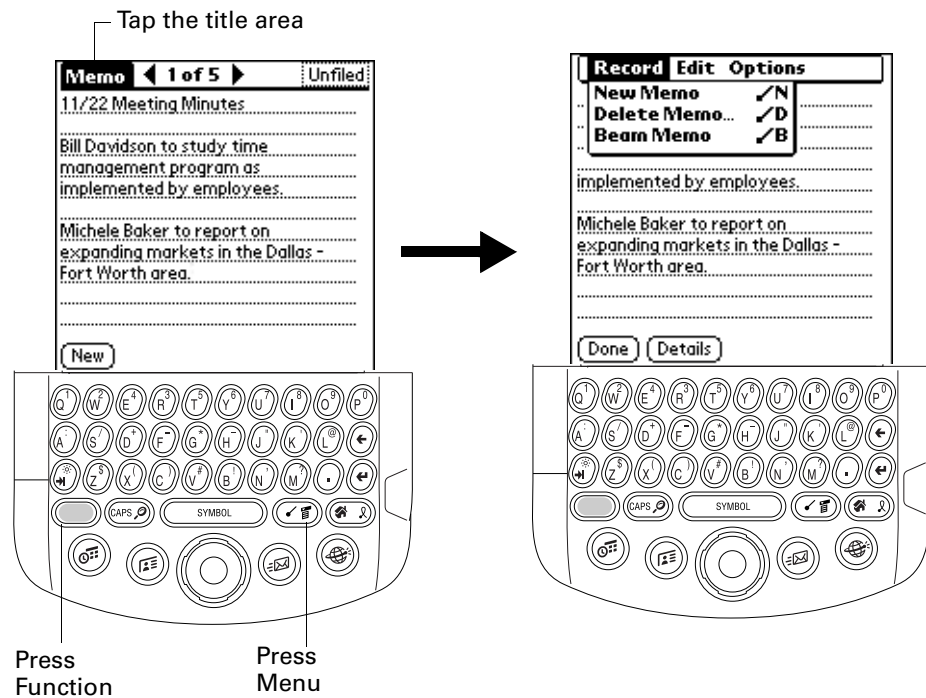

In this example, three menus are available: Record, Edit, and Options. The Record menu is selected and contains the commands New Memo, Delete Memo, and Beam Memo.

Choosing a menu

The menus and menu commands that are available depend on the application that is currently open. Also, the menus and menu commands vary depending on which part of the application you're currently using. For example, in Memo Pad the menus are different for the Memo list screen and the Memo record screen.

To select a menu command with the stylus:

1. Tap the menu bar for an application.
2. Tap the menu that contains the command you want to use.
3. Tap the command you want to use.

TIP After you open the menu bar, you can also press Right and Left on the navigator to select a menu, press Down on the navigator to select the command you want to use, and then press Select on the navigator to run the command.



Menu commands

Most menu commands have an equivalent Command stroke, which is similar to the keyboard shortcuts used to execute commands on computers. For information on using menu commands see “[Displaying online tips](#)” in [Chapter 3](#).



Choosing application preferences

You can set options that affect an entire application in the application’s Preferences dialog box.

To change preferences for an application:

1. Open an application.
2. Press Command Stroke  + R.
 - Alternately, press Function  + Menu , and then select Preferences on the Options menu.

NOTE Not all applications have a Preferences command.

3. Make changes to the settings.
4. Press Function  + Enter , or tap OK.





Performing common tasks

The tasks described in this section use the term *records* to refer to an individual item in any of the applications: a single Date Book event, Address Book entry, To Do List item, Memo Pad memo, Note Pad note, or Expense item.

Creating records

You can use the following procedure to create a new record in Date Book, Address Book, To Do List, Memo Pad, Note Pad, and Expense.

To create a record:

1. Select the application in which you want to create a record.
2. Tap New.
3. In Date Book only: Select start and end times for your appointment, and press Function  + Enter , or tap OK.
4. Enter text for the record.
5. (Optional) Tap Details to select attributes for the record. (In Note Pad the Details command is located on the Options menu.)
6. In Address Book, Note Pad, and Memo Pad only: Press Function  + Enter , or tap Done.

There’s no need to save the record because your handheld saves it automatically.

Editing records

After you create a record, you can change, delete, or enter new text at any time. Two screen features tell you when your handheld is in editing mode:

- A blinking cursor
- One or more dotted edit lines

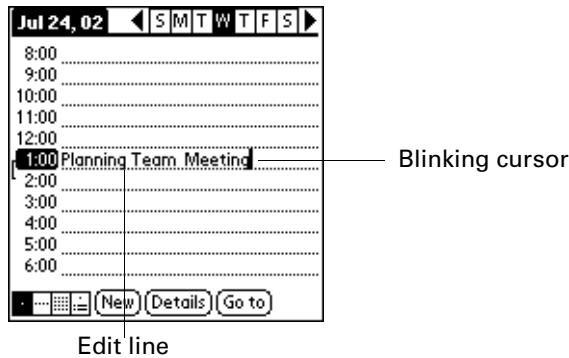

NOTE In Note Pad you can write anywhere on the screen. Therefore, you will not see an edit line or blinking cursor unless the cursor is in the title line.

Entering text

For information on how to enter text using the keyboard on your handheld or the keyboard attached to your computer, see [Chapter 3](#). For information on entering text in Note Pad, see [Chapter 12](#).

Using the Edit menu



The Edit menu is available with any screen where you enter or edit text. In general, commands available in the Edit menu apply to text that you *select* in an application.

To select text in an application:

1. Tap the beginning of the text that you want to select.
2. Drag the stylus over the text to highlight it (in yellow).

NOTE You can also double-tap to select a word, or triple-tap to select a line of text. You can also drag *across* the text to select additional words, or drag *down* to select a group of lines.

The following commands may appear in an Edit menu:



Undo	Reverses the action of the <i>last edit</i> command. For example, if you used Cut to remove text, Undo restores the text you removed. Undo also reverses deletions you made using the backspace.
Cut	Removes the selected text and stores it temporarily in the memory of your handheld. You can paste the text you cut into another area of the current application or into a different application.
Copy	Copies the selected text and stores it temporarily in the memory of your handheld. You can paste the copied text into another area of the current application or into a different application.
Paste	Inserts the cut or copied text at the selected point in a record. The text you paste replaces any selected text. If you did not previously cut or copy text, Paste does nothing.
Select All	Selects all the text in the current record or screen. This enables you to cut or copy all of the text and paste it elsewhere.
Keyboard	Opens the onscreen keyboard. After you finish with the onscreen keyboard, press Function  + Enter  , or tap Done.

Deleting records

To delete a record using the menu command:

1. Select the record you want to delete.
2. Press Command Stroke  + D.

To delete a record using the Menu:

1. Select the record you want to delete.
2. Press Function  + Menu .
3. Select Record, and then select one of the following Delete commands:

Date Book: Delete Event

Address Book: Delete Address



To Do List: Delete Item

Note Pad: Delete Note

Memo Pad: Delete Memo

Expense: Delete Item



A confirmation dialog box appears. If you want to save a copy of the deleted item to an archive file in Palm™ Desktop software, be sure that the check box is selected. If you don't want to save a copy, tap the check box to deselect it.

4. Press Function  + Enter , or tap OK.

If you choose to save a copy of the selected item, your handheld transfers it to the archive file on your desktop the next time you perform a HotSync operation. (The archive option is not available in Note Pad.)

Other ways to delete records

You can also delete records in the following ways:

- Delete the text of the record.
- In Date Book, Address Book, To Do List, and Memo Pad, open the Details dialog box for the record, tap Delete, and then press Function  + Enter , or tap OK.

NOTE When deleting a repeating event in Date Book, you can choose to delete the current repeating event, current and future events, or all instances of that event.

- In Note Pad, open the note you want to delete, and then tap Delete.

Purging records

Over time, as you use Date Book, To Do List, and Expense, you'll accumulate records that have outlived their usefulness. For example, events that occurred months ago remain in the Date Book, and To Do List items that you marked as completed remain in the list, as do Expense items.

All these outdated records take up memory on your handheld, so it's a good idea to remove them by using Purge. If you think Date Book or To Do List records might prove useful later, you can purge them from your handheld and save them in an archive file on your computer.

Purging is not available in Address Book, Note Pad, or Memo Pad; you must delete outdated records manually from these applications.

To purge records:

1. Open the application.
2. Press Command Stroke  + E.

Alternately, press Function  + Menu , and then select Purge on the Record menu.

A confirmation dialog box appears.

Date Book: Tap the pick list and select how old a record must be to be purged. Purge deletes repeating events if the last of the series ends before the date that you purge records.

Date Book, To Do List: If you want to save a copy of the purged records to an archive file on your desktop, be sure that the check box is selected. If you don't want to save a copy, tap the check box to deselect it.

Expense: Select the category you want to purge. All data in the selected category will be purged and there is no archive option.

3. Press Function  + Enter , or tap OK or Done.

If you chose to save a copy of the purged records, your handheld transfers them to an archive file on your desktop the next time you perform a HotSync operation.

NOTE Purging does not happen automatically. You must select the command to make it happen.

Categorizing records

You can categorize records in the Address Book, To Do List, Note Pad, Memo Pad, and Expense applications so that they are grouped logically and are easy to review.

When you create a record, your handheld automatically places it in the category that is currently displayed. If the category is All, your handheld assigns it to the Unfiled category. You can leave an entry as Unfiled or assign it to a category at any time.

By default, your handheld includes system-defined categories, such as All and Unfiled, and user-defined categories, such as Business and Personal.

You cannot modify the system-defined categories, but you can rename and delete the user-defined categories. In addition, you can create your own user-defined categories. You can have a maximum of 15 user-defined categories in each application.

When you have an expansion card properly seated in the expansion card slot, the last item in the category pick list is the name of the expansion card. You cannot otherwise categorize applications that reside on an expansion card.

Address Book contains the QuickList user-defined category, in which you can store the names, addresses, and phone numbers you might need in emergencies (doctor, fire department, lawyer, and so on).

Expense contains two user-defined categories, New York and Paris, to show how you might sort your expenses according to different business trips.



The illustrations in this section come from Address Book, but you can use these procedures in all the applications in which categories are available.

To move a record into a category:

1. Select the record you want to categorize.
2. In Address Book only: Tap Edit.
3. Tap Details.

4. Tap the Category pick list to display the list of available categories.



5. Select the category for the record.
6. Press Function  + Enter , or tap OK.

NOTE In Address Book, Note Pad, and Memo Pad you can select the category name in the upper-right corner of the screen to assign the item to a different category.

To display a category of records:

1. Tap the category pick list in the upper-right corner of the list screen.

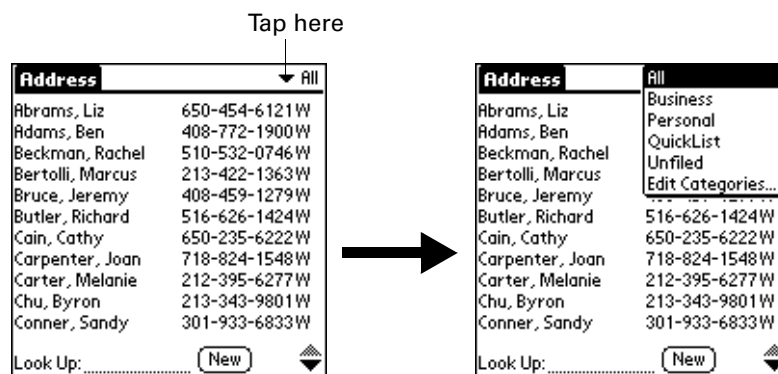

NOTE In the Date Book Agenda view, the pick list is in the upper right of the To Do list.

2. Select the category you want to view.

The list screen now displays only the records assigned to that category.

TIP Pressing an application button on your handheld scrolls through all the categories of that application except for Unfiled. This feature is not available in Date Book.

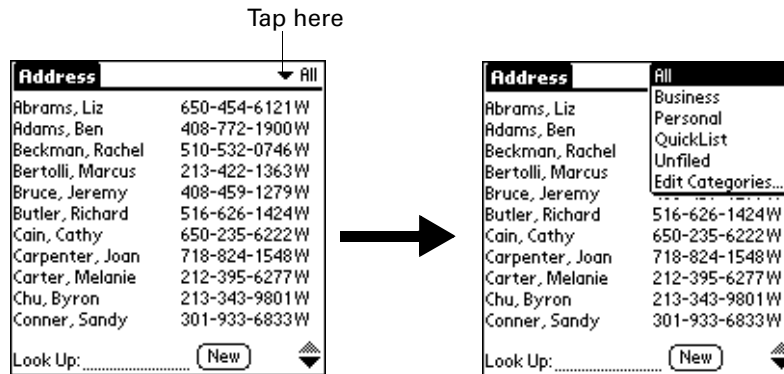

To define a new category:

1. Tap the category pick list in the upper-right corner of the screen or list.





2. Select Edit Categories.
3. Tap New.



4. Enter the name of the new category, and then press Function  + Enter , or tap OK.





5. Press Function  + Enter , or tap OK.

You can assign any of your records to the new category.



To rename a category:

1. Tap the category pick list in the upper-right corner of the screen or list.
2. Select Edit Categories.
3. Select the category that you want to rename, and then tap Rename.



4. Enter the new name for the category, and then press Function  + Enter , or tap OK.



5. Press Function  + Enter , or tap OK.

TIP You can group the records in two or more categories into one category by giving the categories the same name. For example, if you change the name of the Personal category to Business, all records formerly in the Personal category appear in the Business category.

Finding information

Your handheld offers several ways to find information quickly:

- **All applications that reside on your handheld:** Find locates any text that you specify, always starting with the current application. However, Find does not search through applications on expansion cards.
- **Date Book, To Do List, Memo Pad:** Phone Lookup displays the Address list screen and enables you to add to a record the information that appears in this list.
- **Address Book:** The Look Up line enables you to scroll immediately to a name when you enter the first letters of that name.
- **Expense:** Lookup displays the names in your Address Book that have data in the Company field. You can add these names to a list of attendees associated with an Expense record.

Looking up Address Book records

In Address Book, you can use the Look Up line with the stylus or the navigator to look up and quickly scroll to any of your Address Book entries.

To look up an Address Book record with the stylus:

1. From the Address list screen, enter the first letter of the name you want to find.

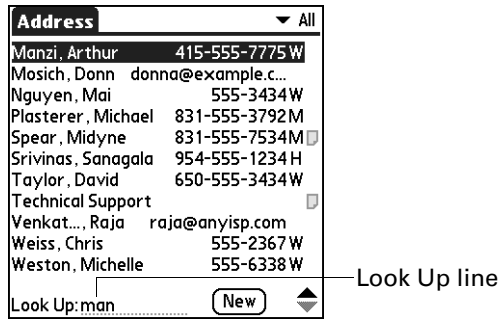

The list scrolls to the first entry that begins with that letter. If you write another letter, the list scrolls to the first entry that starts with those *two* letters. For example, writing an *s* scrolls to “Sands,” and writing *sm* scrolls further to “Smith.” If you sort the list by company name, the Look Up feature scrolls to the first letter of the company name.

2. Tap the record to view its contents.

To look up an Address Book record with the navigator:

1. From the Address List screen, press Right on the navigator to display the navigator Quick Look Up line.
2. Press Up or Down on the navigator to select the first letter of the name you want to find.

The list scrolls to the first entry that begins with that letter.

3. Press Right on the navigator to move to the next letter box.

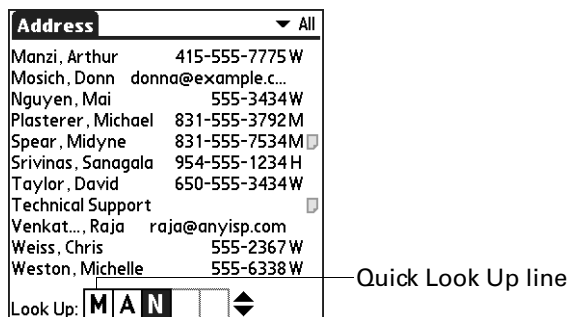

The Quick Look Up line displays only letters that are a possible match for that position.

If only one match is possible for a particular position, the highlight jumps to the next position.

4. Press Up or Down on the navigator to select the next letter of the name you want to find.

The list then scrolls to the first entry that starts with those *two* letters. For example, selecting *s* scrolls to “Sands,” and selecting *sm* scrolls further to “Smith.” If you sort the list by company name, the Quick Look Up feature scrolls to the matches for the company name.



5. Repeat steps 3 and 4 until the entry you want appears in the list.
6. Press Select on the navigator to highlight the record you want.
7. Press Select on the navigator to view the contents of the selected record.

TIP If only one match is possible for the letters you selected, the contents of the record displays automatically.

Using Find

You can use Find to locate any text that you specify, in any application that resides on your handheld. Find does not search applications that reside on an expansion card.

To use Find:



1. Press Function  + Find .

TIP If you select text in an application before you tap Find, the selected text automatically appears in the Find dialog box.

2. Enter the text that you want to find.

Find is not case-sensitive. For example, searching for the name “davidson” also finds “Davidson.”

Find locates any words that begin with the text you enter. For example, searching for “plane” finds “planet” but not “airplane.”

3. Press Function  + Enter , or tap OK.

Find searches for the text in all records and all notes.

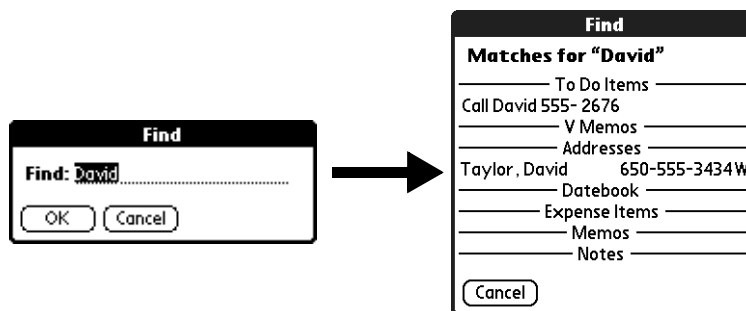

As your handheld searches for the text, you can tap Stop at any time. You may want to do this if the entry you want appears before your handheld finishes the search. To continue the search after you tap Stop, tap Find More.

4. Tap the text that you want to review.



Using Phone Lookup

Phone Lookup displays the Address list screen and enables you to add the information that appears in this list to a record.

To use Phone Lookup:

1. Display the record in which you want to insert a phone number. The record can be in Date Book, To Do List, Memo Pad, or any other application that takes advantage of this feature.

2. Press Command Stroke  + L.

Alternately, press Function  + Menu  and then select Phone Lookup on the Options menu.

3. Begin to spell the last name of the name you want to find.

The list scrolls to the first record in the list that starts with the first letter you enter. Continue to spell the name you're looking for, or when you see the name, tap it.

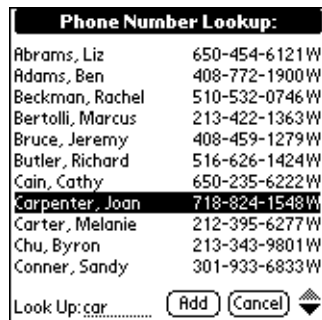

4. Tap Add.

The name you selected, along with the other information associated with it, is pasted into the record you selected in step 1.

Looking up names to add to Expense records

In Expense, Lookup displays the names in your Address Book that have data in the Company field. You can add these names to a list of attendees associated with an Expense record.

To add names to an Expense record:

1. Tap the Expense record to which you want to add names.
2. Tap Details.

Receipt Details

Category: ▼ Unfiled
 Type: ▼ Lunch
 Payment: ▼ Unfiled
 Currency: ▼ \$
 Vendor:
 City:
 Attendees: Who...
 OK Cancel Delete Note ↑

3. Tap Who.

Receipt Details

Category: ▼ Unfiled
 Type: ▼ Lunch
 Payment: ▼ MasterCard
 Currency: ▼ \$
 Vendor: Rosie's Cafe
 City: San Francisco
 Attendees: Who... Tap here
 OK Cancel Delete Note ↑

Attendees

.....





 Done Lookup R A ↑

4. Tap Lookup.

The Attendees Lookup screen displays all the names in your Address Book that have data in the Company field.

5. Select the name you want to add, and then tap Add.

The name appears in the Attendees screen.

6. Repeat steps 4 and 5 to add more names.
7. Press Function  + Enter , or tap Done.
8. Press Function  + Enter , or tap OK.



Sorting lists of records

You can sort lists of records in various ways, depending on the application. Sorting is available in applications that have list screens: Address Book, Note Pad, To Do List, Memo Pad, and Expense.

NOTE You can also assign records to categories. See “Categorizing records” earlier in this chapter.

To sort records in Address Book, Note Pad, and Memo Pad:

1. Open the application to display the list screen.
2. Press Command Stroke  + R.

Alternately, press Function  + Menu , and then select Preferences on the Options menu.

Address Book

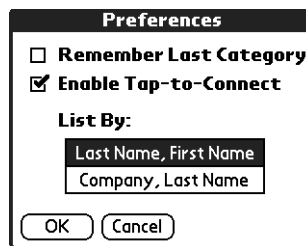

Note Pad

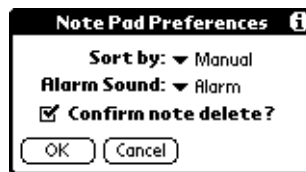

Memo Pad

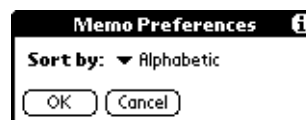



3. Do one of the following:

Address Book: Tap the setting you want.

Note Pad: Tap the Sort by pick list and select Alphabetic, Date, or Manual.



Memo Pad: Tap the Sort by pick list and select Alphabetic or Manual.

4. Press Function  + Enter , or tap OK.

To sort the Note Pad and Memo list manually, tap and drag a note or memo to a new location in the list.

To make the list appear in Palm Desktop software as you manually sorted it on your handheld, open the application in Palm Desktop software and click Sort by. Then select Order on Handheld.

To sort records in To Do List and Expense:

1. Open the application to display the list screen.
2. Tap Show.
3. Tap the Sort by pick list and select an option.
4. Press Function  + Enter , or tap OK.



Attaching notes

In Address Book, Date Book, To Do List, and Expense, you can attach a note to a record. A note can be up to several thousand characters long. For example, for an appointment in Date Book, you can attach a note with directions to the location.

To attach a note to a record:

1. Display the entry to which you want to add a note.

To display an entry, tap it or press Up or Down on the navigator to highlight it, and then press Select on the navigator.

2. In Address Book only: Tap Edit.
3. Tap Details.
4. Tap Note.
5. Enter your note.
6. Press Function  + Enter , or tap Done.

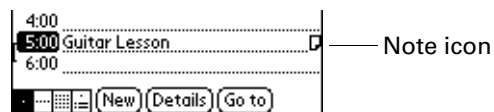

A small note icon appears at the right side of any item that has a note.

**To review or edit a note:**

- Tap the Note icon .

TIP In Date Book, you can also select the event that contains the note, press Select on the navigator to open the note, and then press Select on the navigator again to close the note.

To delete a note:

1. Tap the Note icon .
2. Tap Delete.
3. Press Function  + Enter , or tap Yes.

Choosing fonts

In many applications, you can change the font style to make text easier to read. You can choose small, small bold, large, or large bold fonts in each application that enables you to change font style.



Small font



Small bold font



Large font



Large bold font

To change the font style:

1. Open an application.
2. Press Command Stroke (⌘) + F.

Alternately, press Function (fn) + Menu (⌘), and then select Font on the Options menu.

3. Tap the font style you want to use.

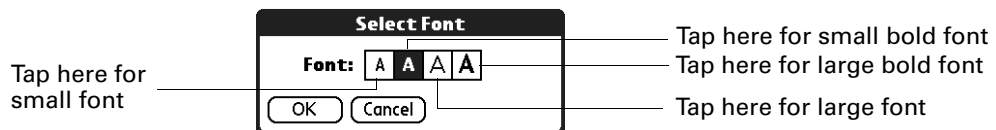

4. Press Function (fn) + Enter (↵), or tap OK.

Receiving alerts

You can receive alerts on your handheld and in Palm Desktop software.

Receiving alerts on your handheld



When you use certain application settings, your handheld can alert you to any of the following:

- An appointment set in Date Book
- A note created in Note Pad
- An alarm set in World Clock

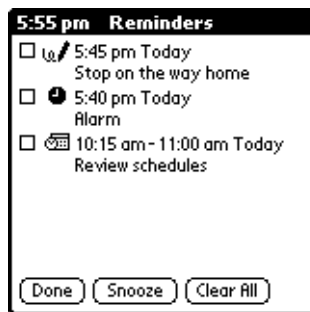
When an alert occurs, your handheld displays a reminder message. If you tap Snooze in response to an alert message, your handheld reminds you of the item again in five minutes. The Reminder screen displays alerts that await attention.



To respond to alerts, do one of the following:

- Select an item's check box to clear the item.
- Tap an item (either the icon or the text description) to open the application where the alarm was set. The application opens to the entry associated with the alarm.
- Press Function  + Enter , or tap Done to close the reminder list and return to the current screen. An attention indicator blinks in the upper-left corner of the screen; tap it to view the alert list again.
- Tap Snooze to see the list again in five minutes.

If you tap Done or Snooze and view the reminder list later, the current time is displayed in the Reminder bar and the original alert time is displayed with each list item.

- Tap Clear All to dismiss all alerts in the list.

Receiving alerts from Palm Desktop software

You can also set an option to receive Date Book event alerts from Palm Desktop software. The feature is disabled by default, so you must enable it within Palm Desktop software.

To enable an event alert from Palm Desktop software:

1. Double-click the Palm Desktop icon.
2. From the Tools menu, select Options, and then select Alarms.
3. Set Alarm Configuration options, either Always Available or Available only when the Palm Desktop is running.
4. (Optional) To hear an alert sound as well as receive an alert message, select the check box Play audible notification with alarm dialog.
5. Click OK.

Hiding or masking private records

You can use the Security preferences to set a password and select whether to mask your private records or hide them completely. See “Security preferences” in [Chapter 21](#) for details.

Installing and removing applications

This section explains how to install and remove applications on your handheld or on an expansion card, and how to remove Palm Desktop software from your computer.

Installing add-on applications

Your handheld comes with applications installed and ready to use, but you can also install additional applications, such as games and other software, on your handheld or on a card that is seated in the expansion card slot. Applications or games that you install on your handheld reside in RAM memory, and you can delete them at any time.

The Install Tool makes it easy to install software during a HotSync operation. There are a variety of third-party applications available for your handheld. To learn more about these applications, go to the web site: www.palm.com/support/intl.

To install add-on software on your handheld using a Windows computer:

1. On your computer, copy or download the application you want to install into the add-on folder in your Palm Desktop directory on your computer.
2. Double-click the Palm Desktop icon on your desktop.
3. Click Install.

TIP You can also access the Install Tool dialog by selecting Install Tool from the Palm Desktop program group or by double-clicking any file with a PRC, PDB, PQA, PNC, or SCP file extension.

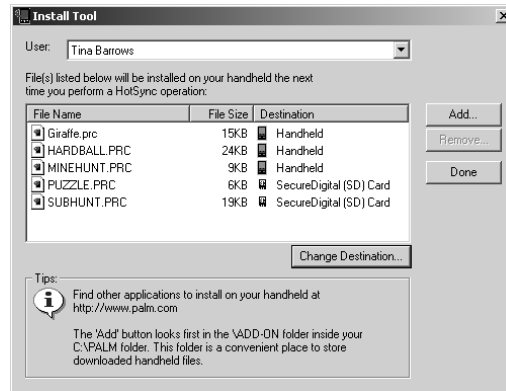

4. In the User drop-down list, select the name that corresponds to your handheld.
5. Click Add.

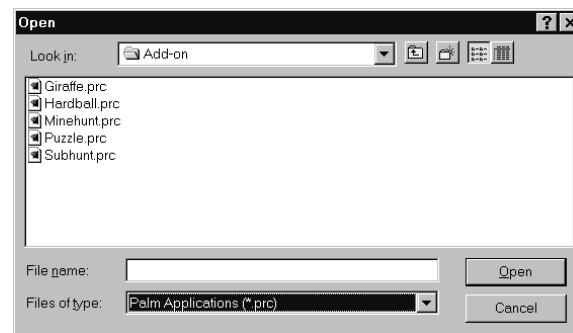

6. Select the applications that you want to install.
7. Click Open.
8. If you need to change the destination of the application you are installing, click Change Destination in the Install Tool window, and then use the arrows to move applications between your handheld and an expansion card.

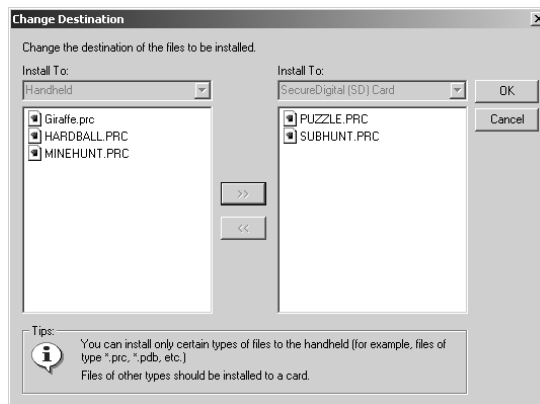

9. Click OK to close the Change Destination window.
10. Click Done to close the Install Tool window.
11. Perform a HotSync operation to install the selected applications.
See “Performing a cradle/cable HotSync operation: Windows computer” in Chapter 20 for details.

NOTE Files that remain in the list after you perform a HotSync operation were not installed. This can happen if the file type was not recognized during the HotSync operation. Expansion cards may hold applications that use files other than the Palm™ application files. For your handheld to recognize such a file, you must launch the application at least once.

To install add-on software on your handheld using a Mac computer:

1. On your Mac computer, copy or download the application you want to install into the Add-on folder in your Palm folder.
2. Double-click the HotSync Manager icon in the Palm folder.
3. From the HotSync menu, select Install Handheld Files.

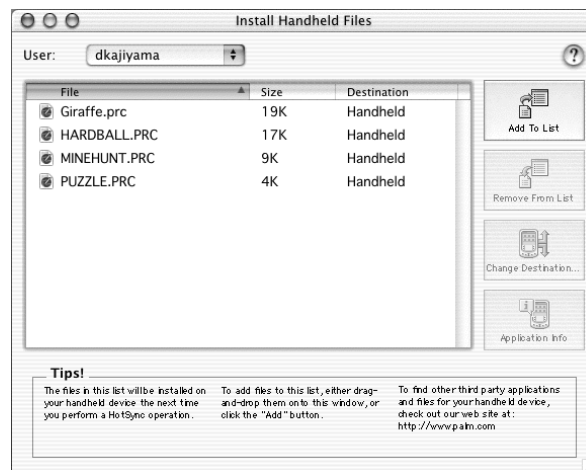

4. From the User pop-up menu, select the name that corresponds to your handheld.
5. Click Add To List.

6. Select the Add-on folder.

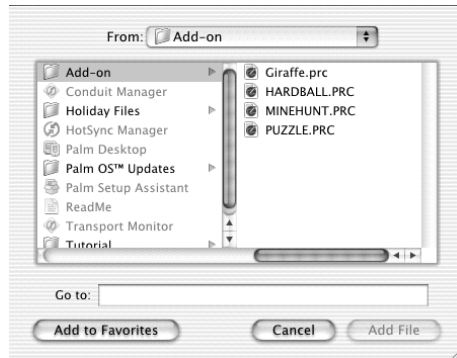

If the file you want to install is not listed in the dialog box, go to the folder to which you copied the file. Most Palm application files have the extension PRC, PDB, PQA, or SCP.

7. Select the applications you want to install.
8. Click Add File to add the selected application to the Install Handheld Files list.

TIP You can also drag files or folders of files to the list in the Install Handheld Files dialog box. The files are copied to the Files To Install folder.

9. If you need to change the destination of the application you are installing, click Change Destination the Install Handheld Files window, and then use the arrows to move applications between your handheld and an expansion card.



10. Click OK to close the Change Destination window.
11. Close the Install Handheld Files window.
12. Perform a HotSync operation to install the selected applications on your handheld. See [“Performing cradle/cable HotSync operations”](#) in [Chapter 20](#) for details.

NOTE Files that remain in the list after you perform a HotSync operation were not installed. This can happen if the file type was not recognized during the HotSync operation. Expansion cards may hold applications that use files other than the Palm application files. In order for your handheld to recognize such a file, you must launch the application at least once.

Removing applications

If you run out of memory or decide that you no longer need an application you installed, you can remove applications from your handheld or from an expansion card. From your handheld, you can remove only add-on applications, patches, and extensions that you install; you cannot remove the applications that reside in the ROM portion of your handheld.

NOTE If you have backed up your applications during a HotSync operation, you also need to delete them from your computer. Otherwise, they are reinstalled at the next HotSync operation.

To remove an add-on application:

1. Press Home (🏠).
2. Press Command Stroke (⌘) + D.
Alternately, press Function (fn) + Menu (⌘), select Delete on the App menu.
3. Tap the Delete From pick list and select either Handheld or Card. To delete applications from a card, the card must be seated in the expansion card slot.
4. Tap the application that you want to remove.



5. Tap Delete.
6. Press Function (fn) + Enter (↵), or tap Yes.
7. Press Function (fn) + Enter (↵), or tap Done.

Removing Palm Desktop software

If you no longer want to use Palm Desktop software, you can remove it from your computer.

To remove Palm Desktop software from a Windows computer:

1. From the Windows Start menu, select Settings and then Control Panel.
2. Double-click the Add/Remove Programs icon.
3. Click the Change or Remove Programs button.
4. Select Palm Desktop.

5. Click Change/Remove.
6. Click Yes in the Confirm File Deletion box.
7. Click OK.
8. Click Close.

NOTE You need to install the HotSync Manager from the installation CD if you want to synchronize data with another PIM.

To remove Palm Desktop software from a Mac computer:

1. Locate the Palm Desktop Installer icon and double-click.

The Palm Desktop Installer icon is on the Palm Desktop CD or in the installer that you downloaded.

2. Select Uninstall from the pop-up menu.
3. Select the software you want to remove.
4. Click Uninstall.
5. Select the folder that contains your Palm Desktop software files.
6. Click Remove.

NOTE This process removes only the application files. The data in your Users folder remains untouched.

7. Restart your computer.

Using Address Book

 Address Book enables you to keep names, addresses, phone numbers, and other information about your personal or business contacts. Use Address Book to do the following:



- Quickly look up or enter names, addresses, phone numbers, and other information.
- Enter up to five phone numbers (home, work, fax, mobile, and so on) or e-mail addresses for each name.
- Define which phone number appears in the Address list for each Address Book entry.
- Attach a note to each Address Book entry, in which you can enter additional information about the entry.
- Assign Address Book entries to categories so that you can organize and view them in logical groups.
- Create your own digital business card that you can beam using SMS or e-mail to other devices with an infrared (IR) port and an application that can read the data.

To open Address Book:

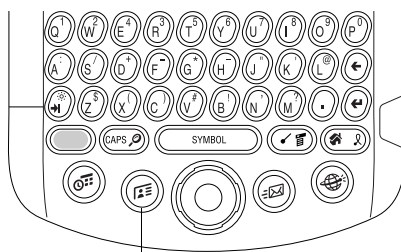
- Press the Address Book application button  on the front panel of your handheld. Address Book opens to display the list of all your records.



Address Book button

TIP Press the Address Book application button  repeatedly to cycle through the categories in which you have records. You can also press and hold the Address Book application button  to instantly beam your business card to another device with an IR port. The receiving device must also have an application that can read the Address Book data.

Creating an Address Book entry

A record in Address Book is called an *entry*. You can create entries on your handheld, or you can use Palm™ Desktop software to create entries on your computer and then transfer the entries to your handheld with your next HotSync® operation.

Palm Desktop software also has data import capabilities so that you can load database files into Address Book on your handheld.

See “Importing data” in Chapter 3 and Palm Desktop online Help for more information.

To create a new Address Book entry:

1. Press the Address Book button  on the front of your handheld to display the Address list.
2. Tap New.

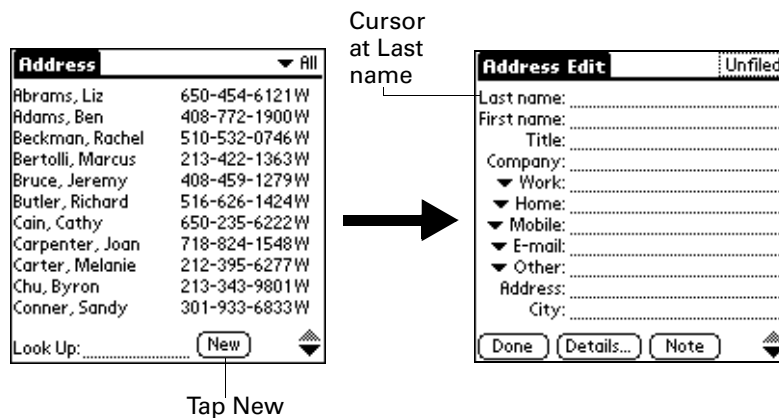

3. Enter the last name of the person you want to add to your Address Book.



The handheld automatically capitalizes the first letter of each field (except numeric and e-mail fields). You do not have to use the CAPS key to capitalize the first letter of the name.

4. Tap the First Name field.

TIP Pressing Tab  moves the cursor to the next field.

5. Enter the first name of the person in the First Name field.
6. Enter the other information that you want to include in this entry.

As you enter letters in the Title, Company, City, and State fields, text appears for the first logical match that exists in your Address Book. As you enter more letters, a closer match appears. For example, you may already have Sacramento and San Francisco in your Address Book. As you enter *S*, Sacramento appears, and as you continue entering *a* and *n* San Francisco replaces Sacramento. As soon as the word you want appears, tap the next field to accept the word.

7. Tap the scroll arrows  or press Up/Down on the navigator to move to the next page of information.
8. After you finish entering information, Press Function  + Enter , or tap Done.

Tap Done

TIP To create an entry that always appears at the top of the Address list, begin the Last name or Company field with a symbol, as in *If Found Call*. This entry can contain contact information in case you lose your handheld.

Selecting types of phone numbers

You can select the types of phone numbers or e-mail addresses that you associate with an Address Book entry. Any changes you make apply only to the current entry.

To select other types of phone numbers in an entry:

1. Tap the entry that you want to change.
2. Tap Edit.
3. Tap the pick list next to the label you want to change.

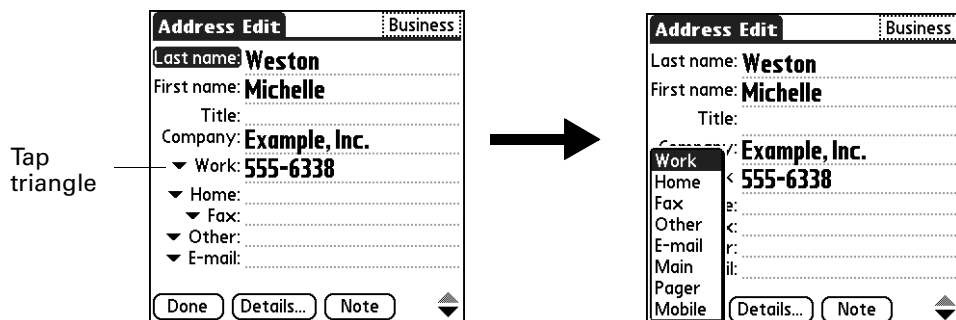

4. Select a new label.

Changing Address Entry details

The Address Entry Details dialog box provides a variety of options that you can associate with an entry.

To open the Address Entry Details dialog box:

1. Tap the entry whose details you want to change.
2. Tap Edit.
3. Tap Details.



4. Select any of the following settings:

Show in List	Select which type of phone or other information appears in the Address list screen. Your options are Work, Home, Fax, Other, E-mail, Main, Pager, and Mobile. The identifying letters <i>W, H, F, O, M, or P</i> appear next to the record in the Address list, depending on which information is displayed. If you select E-mail, no identifying letter is displayed.
Category	Assign the entry to a category.
Private	Hide this entry when Security is turned on.

Making connections from Address Book

You can use the entries in your Address Book to launch applications that perform tasks such as dialing a phone number or creating an e-mail or SMS message. Some of the applications you can launch are included with your handheld, and others may be available from third-party developers and are sold separately.

Quick Connect

You can use Quick Connect to select an entry and initiate a related task with one hand using the navigator. You can also configure which application opens when you choose a specific Address record field, and whether to add a prefix to all phone numbers.

To make a connection with Quick Connect:

1. Open the Address entry to which you want to connect.
2. Press Right on the navigator to open the Quick Connect dialog box.

TIP You can also tap the Quick Connect icon in the title bar of the Address record.

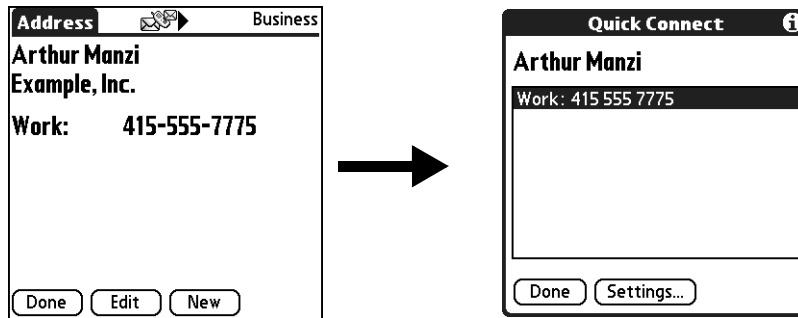

3. Select the method you want to use to connect.

Quick Connect opens and initiates the related task. For example, if you tap a phone number, Quick Connect sends the selected phone number to your mobile phone.

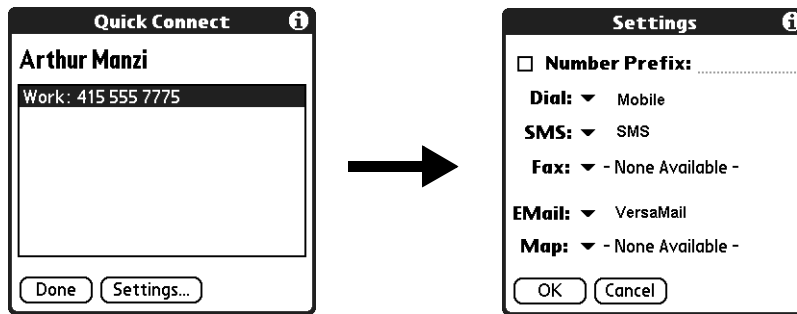

To configure Quick Connect settings:

1. From the Quick Connect dialog box, tap Settings.



2. (Optional) Tap the Number Prefix check box and enter a prefix.

For example, to dial 1 before all phone numbers, select this check box and enter a "1" in this field. The prefix is not added to a number that begins with the "+" character.



3. Tap each of the pick lists and select the application you want to associate with that task.
4. Press Function  + Enter , or tap OK.

Tap-to-Connect

Tap-to-Connect enables you to select an entry and initiate a related task by tapping it with the stylus. By default, Tap-to-Connect is enabled.

To enable Tap-to-Connect:

1. Press Command Stroke  + R.

Alternately, press Function  + Menu , and then select Preferences on the Options menu.

2. Tap Enable Tap-to-Connect.
3. Tap OK.

TIP You can also configure which application opens when you tap a specific Address record field, and whether to add a prefix to all phone numbers. See [“Quick Connect”](#) earlier in this chapter to learn how to configure these settings.

To make a connection with Tap-to-Connect:

1. From the Address list, tap the entry to which you want to connect.
2. Tap the item you want to launch in Mobile.

For example, to dial a phone number, tap the number you want to dial. To address an e-mail message, tap an e-mail address.

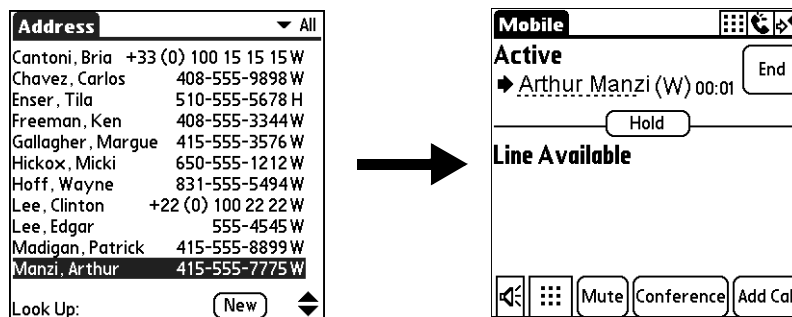

Address Book menus

Address Book menus are shown here for your reference, and Address Book features that are not explained elsewhere in this book are described here.

See “Using menus” in [Chapter 4](#) for information about selecting menu commands.

The Record and Options menus may differ, depending on whether you’re displaying the Address list screen or the Address view screen.

Record menus

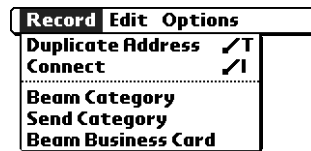

Address list

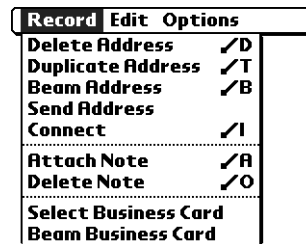

Address view

- | | |
|--------------------------|--|
| Duplicate Address | Makes a copy of the current record and displays the copy in Address Edit so you can make changes to the copied record. The copy has the same category and attached notes as the original record. |
| Connect | Opens the Quick Connect dialog box where you can select which application to use to make the connection. |
| Send Category | Opens a dialog box where you can select how to send all records in the selected category to another device. The options available depend on the software installed on your handheld. |
| Send Address | Opens a dialog box where you can select how to send the selected entry to another device. The options available depend on the software installed on your handheld. |

Options menus



Address list



Address view

Preferences

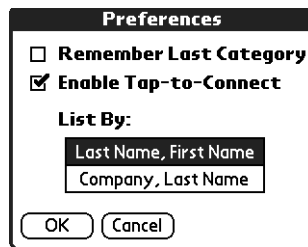

Remember last category: Determines how Address Book appears when you return to it from another application. If you select this check box, Address Book shows the last category you selected. If you clear it, Address Book displays the All category.

Rename Custom Fields

Fields that appear at the end of the Address Edit screen. Rename them to identify the kind of information you enter in them. The names you give the custom fields appear in all entries.

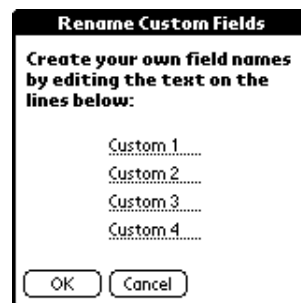

About Address Book



Shows version information for Address Book.

Using Calculator

 Calculator enables you to perform basic calculations. Use Calculator to do the following:

- Perform addition, subtraction, multiplication, division, and square root operations.
- Store and retrieve values.
- Display the last series of calculations, which is useful for confirming a series of “chain” calculations.

To open Calculator:

1. Press Home .
2. Tap the Calculator icon .

Performing calculations

The Calculator includes several buttons to help you perform calculations.

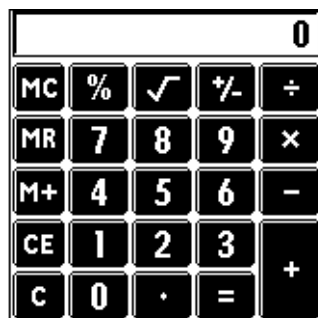

Clears the entire calculation so that you can begin a fresh calculation.



Clears the last number you entered. If you make a mistake while entering a number in the middle of a calculation, you can use this button to reenter the number without starting the calculation over.



Toggles the current number between a negative and positive value. If you want to enter a negative number, enter the number first *and then press* the +/- button.



Places the current number in memory. Each new number you enter with the M+ button is *added to the total* already stored in memory. The number that you add can be either a calculated value or any number you enter by pressing the number buttons. Pressing this button has no effect on the current calculation (or series of calculations); it merely places the value into memory until it is recalled.



Recalls the stored value from memory and inserts it into the current calculation.



Clears any value that is stored in the Calculator memory.



Calculates the square root of a number. Enter the number, and then tap the square root button.

Viewing recent calculations

The Recent Calculations command enables you to review the last series of calculations and is particularly useful for confirming a series of “chain” calculations.

To display recent calculations:

1. Press Command Stroke + I.

Alternately, press Function + Menu , and then select Recent Calculations on the Options menu.

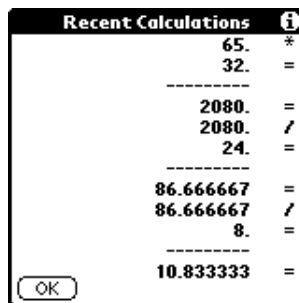

2. After you finish reviewing the calculations, press Function + Enter , or tap OK.

Using Calculator menus

The Calculator menu shown here is for your reference, and the Calculator feature described here is not explained elsewhere in this book.

See “Using menus” in [Chapter 4](#) for information about choosing menu commands.

Options menu

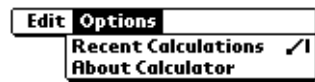

About Calculator Shows version information for Calculator.

Using Card Info



 Card Info enables you to review general information about an expansion card. Use Card Info to do the following:

- Review card contents.
- Rename a card.
- Format a card.

Reviewing Card Information

You can view the card name, type, available storage space, and a summary of its contents.

To review Card Information:

1. Press Home .
2. Tap the Card Info icon .
3. Review Card name, Type, and Size.
4. Review card contents summarized by directory.

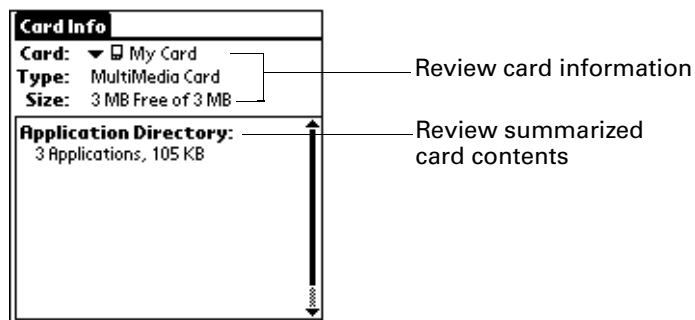

Renaming a card

Renaming a card enables you to give an easy to recognize name to the card.

To rename a card:

1. Press Home (🏠).
2. Tap the Card Info icon (📄).
3. Press Command Stroke (⌘) + R.

Alternately, press Function (fn) + Menu (⌘), and then select Rename Card on the Card menu.

4. Enter the new name for the card.

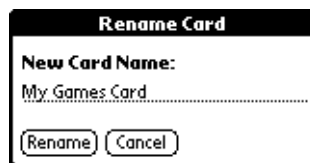

5. Tap Rename.

Formatting a card

Formatting a card destroys all its data and prepares it to accept new applications and data.

To format a card:

1. Press Home (🏠).
2. Tap the Card Info icon (📄).
3. Press Command Stroke (⌘) + F.

Alternately, press Function (fn) + Menu (⌘), and then select Format Card on the Card menu.

4. Press Function (fn) + Enter (↵), or tap OK.

Managing an expansion card

- When writing data to an expansion card, wait for your handheld to complete the operation before removing the card from the slot. This prevents data corruption or accidental damage to the expansion card.
- You can install applications to an expansion card after performing an initial HotSync® operation. See “[Installing add-on applications](#)” in [Chapter 4](#) for information. For optimal performance, we recommend that you do not install more than fifty applications to a single expansion card.
- When your handheld’s battery level becomes very low, access to the expansion card may be disabled to protect your data. If this occurs, recharge your handheld as soon as possible.

Using the Card Info menu

The Card Info menu is shown here for your reference, and the Card Info features that are not explained elsewhere in this book are described here.

See “[Using menus](#)” in [Chapter 4](#) for information about choosing menu commands.

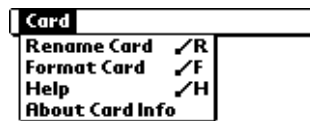

Help Provides help text.

About Card Info Shows version information for Card Info.

Using Date Book

 Date Book enables you to quickly and easily schedule appointments or any kind of activity associated with a time and date. Use Date Book to do the following:

- Enter a description of your appointment and assign it to a specific time and date.
- Display a chart of your appointments for an entire week. The Week view makes it easy to spot available times and potential scheduling overlaps or conflicts.
- Display a monthly calendar to quickly spot days where you have morning, lunch, or afternoon appointments.
- Display an agenda showing appointments, untimed events, and your To Do items for the day.
- Set an alarm to notify you of the scheduled activity.
- Create reminders for events that are based on a particular date, rather than time of day. Birthdays and anniversaries are easy to track with your handheld.
- Attach notes to individual events for a description or clarification of the entry in your Date Book.

To open Date Book:

- Press the Date Book application button  on the front panel of your handheld. Date Book opens to today's schedule.

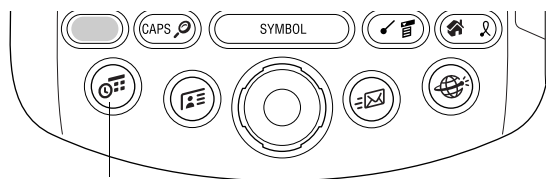

Date Book button

TIP Press the Date Book application button repeatedly to cycle through the Day, Week, Month, and Agenda views.

When you open Date Book, the screen shows the current date and a list of times for a normal business day.

Scheduling an event

A record in Date Book is called an “event.” An event can be any kind of activity that you associate with a day. You can enter a new event on any of the available time lines.

When you schedule an event, its description appears on the time line, and its duration is automatically set to one hour. You can easily change the start time and duration for any event.

It’s possible to schedule events that overlap, but Date Book makes it easy to find such conflicts. See [“Spotting event conflicts”](#) later in this chapter.

You can also schedule events in your Date Book that occur on a particular date but have no specific start or end times, such as birthdays, holidays, and anniversaries. These are referred to as “untimed events.” Untimed events appear at the top of the list of times, marked with a diamond. You can have more than one untimed event on a particular date.

You can also schedule a repeating event, such as a weekly meeting, and continuous events, such as a three-day conference or a vacation.

To schedule an event for the current day:

1. Tap the time line that corresponds to the beginning of the event.

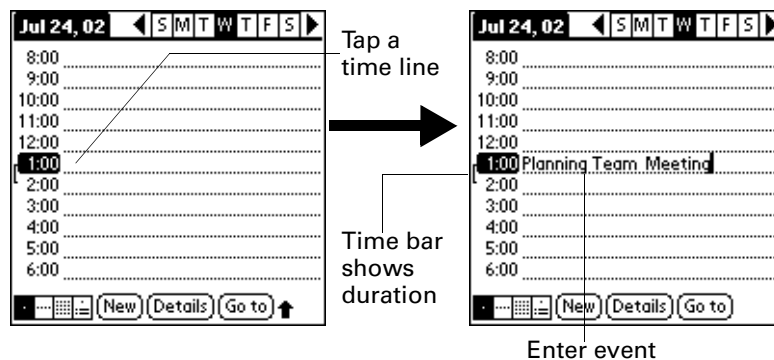

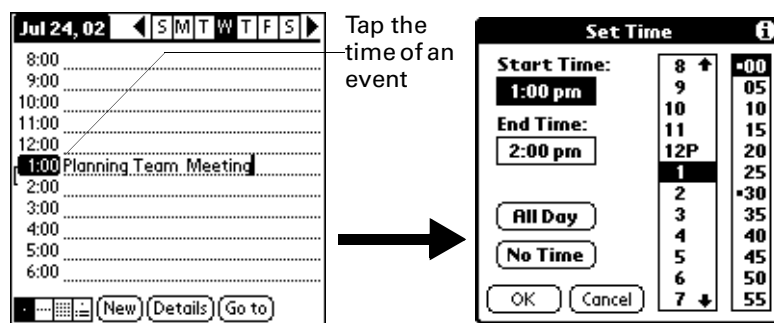

2. Enter a description of the event. You can enter up to 255 characters.
3. If the event is one hour long, skip to step 5. If the event is longer or shorter than an hour, tap the time of the event to open the Set Time dialog box.

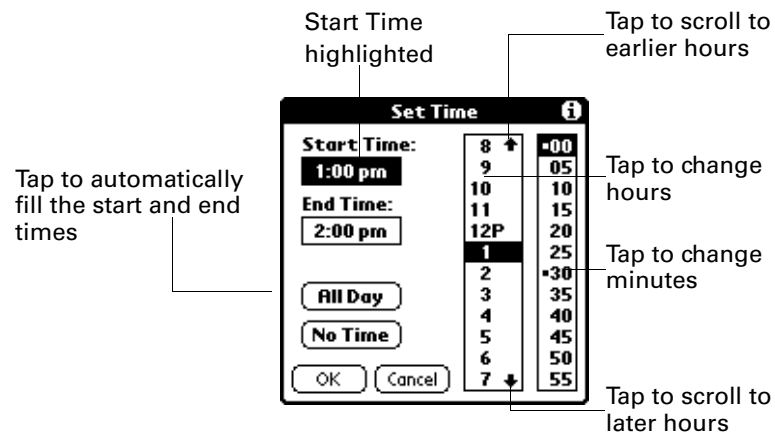

4. Do one of the following:

- Tap the time columns on the right side of the Set Time dialog to set the Start Time, and then tap the End Time box and tap the time columns to set the End Time.
- Tap All Day to automatically insert the start and end time of the event as defined in your Date Book preferences.

5. Press Function  + Enter , or tap OK.

6. Tap a blank area of the screen to deselect the event. A vertical line appears next to the time, indicating the duration of the event.

If an event has the same start and end time, the time is displayed only once.

To schedule an event for another day:

1. Select the date you want for the event by doing one of the following:

- Tap the day of the week that you want in the date bar at the top of the screen. If necessary, tap the Previous week or Next week scroll arrows to move to another week.

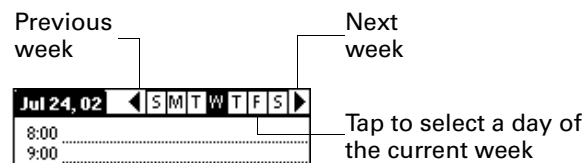

- Press Right or Left on the navigator to scroll to the next or previous day.

- Press Up or Down on the navigator to scroll within the current day.
- Tap Go To at the bottom of the screen to open the Go to Date dialog box. Select a date by tapping a year, month, and day in the calendar.

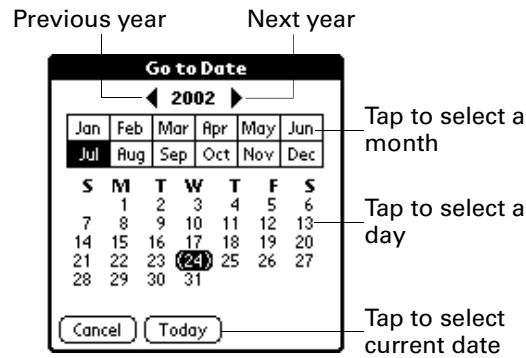

2. After you locate the date, follow the steps for scheduling an event for the current day.

To schedule an untimed event:

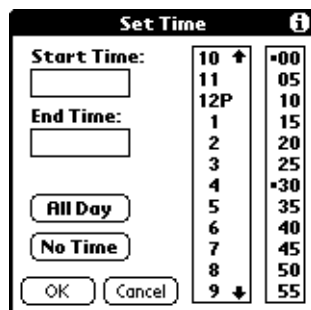

1. Select the date that you want for the event.
2. Tap New.
3. Tap No Time, so that no start or end times are defined for the new event.

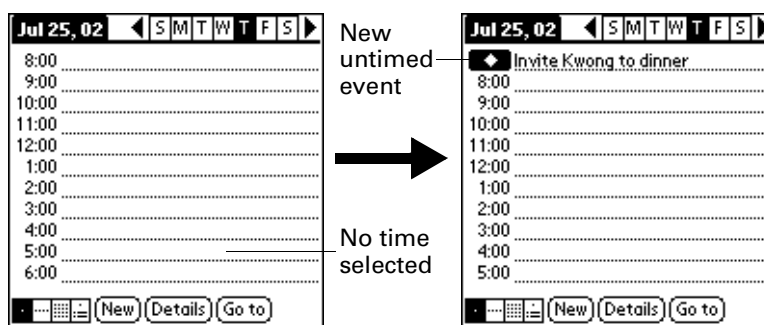

4. Enter a description of the event.



5. Tap a blank area on the screen to deselect the untimed event.

If you create an event and decide later that there is no particular start or end time, you can easily change it to an untimed event. Tap the time of the event in the Date Book screen, tap No Time, and then press Function  + Enter , or tap OK.

Selecting an event

After you create an event, you can select an event to view its contents, reschedule it, make it a repeating event, and add alarms or notes.

To select an event:



1. Go to the day on which the event is scheduled.
2. Tap the event.

TIP You can also press Select on the navigator to insert the highlight on the next event in the current day or on the first event of another day. To scroll through the events in the selected day, press Up and Down on the navigator.

Rescheduling an event

You can easily make changes to your schedule with your handheld.

To reschedule an event:

1. Select the event you want to reschedule.
2. Tap Details.
3. To change the time, tap the Time box and select a new time.
4. To change the date, tap the Date box and select a new date.
5. Press Function  + Enter , or tap OK.

Setting an alarm for an event

The Alarm setting enables you to set an alarm for events in your Date Book. You can set an alarm to notify you minutes, hours, or days before an event. The default Alarm setting is five minutes before the time of the event, but you can change the Alarm to any number of minutes, hours, or days.

When you set an alarm, this icon  appears to the far right of the event with the alarm. When the alarm occurs, a reminder message also appears onscreen.





To set an alarm for an event:

1. Select the event to which you want to assign an alarm.
2. Tap Details.
3. Tap the Alarm check box to select it.

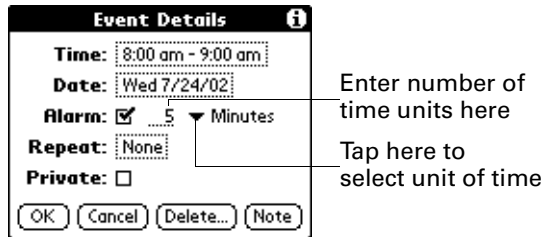
The default setting, 5 Minutes, appears.

4. Tap the pick list to select Minutes, Hours, or Days.
5. Select the 5 and enter any number from 0 to 99 (inclusive) as the number of time units.



6. Press Function  + Enter , or tap OK.
7. When the reminder message appears on screen, do one of the following:
 - Press Function  + Enter , or tap OK, to permanently dismiss the reminder and return to the current screen.
 - Tap Snooze to dismiss the reminder and return to the current screen. The reminder message appears again five minutes after you tap Snooze, and meanwhile an attention indicator blinks in the upper-left corner of the screen to remind you of the pending alarm.
 - Tap Go To to open Date Book. Date Book opens and displays the event associated with the alarm.

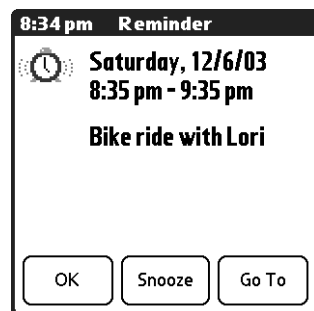

Alarm for untimed events: You can set a silent alarm for an untimed event. In this case, the alarm triggers at the specified period of minutes, hours, or days before midnight (beginning) of the day of the untimed event. When the alarm triggers, the reminder list displays the alarm message until you clear it. See [“Receiving alerts”](#) in [Chapter 4](#) for details.

For example, you might set an alarm for an untimed event that occurs on February 4. If the alarm is set for five minutes, the reminder message appears at 11:55 PM on the night of February 3. The reminder remains in the reminder list until you turn on your handheld and dismiss it.

Scheduling repeating or continuous events

The Repeat function lets you schedule events that recur at regular intervals or extend over a period of consecutive days.



A birthday is a good example of an event that repeats annually. Another example is a weekly guitar lesson that falls on the same day of the week and the same time of day.

A business trip or a vacation is an example of a continuous event.

To schedule a repeating or continuous event:

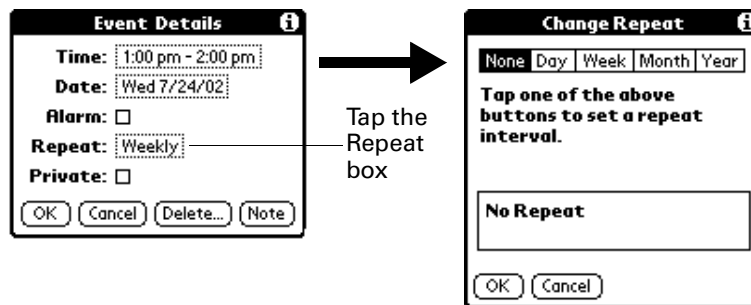
1. Select the event.
2. Tap Details.
3. Tap the Repeat box to open the Change Repeat dialog box.





4. Tap Day, Week, Month, or Year to set how often the event repeats.
For a continuous event, tap Day.
5. On the Every line, enter a number that corresponds to how often you want the event to repeat.
For example, if you select Month and enter the number 2, the event repeats every other month.
6. To specify an end date for the repeating or continuous event, tap the End on pick list and tap Choose Date. Use the date picker to select an end date.
7. Press Function  + Enter , or tap OK.

After you schedule a repeating or continuous event, the Repeat icon  appears to the far right of the event.



Changing repeating or continuous events

When you make changes to a repeating or continuous event, such as deleting or adding notes or changing the time of an event, you can decide which of the events you want to change—all events in the series, just the current event, or the current and future events.

To delete repeating events:

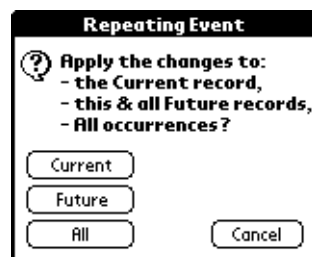
1. Select the record you want to delete.
2. Press Function  + Menu .
3. Select Record, and then select Delete Event.
4. Do one of the following:
 - Tap Current to delete only the current event item.
 - Tap Future to delete the current and all future event items and reset the end date of the repeating event to the last shown date.
 - Tap All to delete all occurrences of the repeating event.



5. Press Function  + Enter , or tap OK.

Considerations for repeating or continuous events

Keep the following points in mind:

- If you change the start date of a repeating event, your handheld calculates the number of days you moved the event. Your handheld then automatically changes the end date to maintain the duration of the repeating event.
- If you change the repeat interval (e.g., daily to weekly) of a repeating event, past occurrences (prior to the day on which you change the setting) are not changed, and your handheld creates a new repeating event.
- If you change the date of an occurrence of a repeating event (e.g., from January 14th to January 15th) and apply the change to all occurrences, the new date becomes the start date of the repeating event. Your handheld adjusts the end date to maintain the duration of the event. If you apply the change to current and future occurrences, past occurrences are not changed.
- If you change other repeat settings (e.g., time, alarm, private) of a repeating event and apply the change to all occurrences, your handheld creates a new event. The start date of this new event is the day on which the setting is changed.
- If you apply a change to a single occurrence of a repeating event (e.g., time), that occurrence no longer shows the Repeat icon .

Changing the Date Book view

In addition to displaying the time list for a specific day, you can also display a whole week, a month, an agenda, and the current time.

To cycle through Day, Week, Month, and Agenda views:

- Press the Date Book application button repeatedly to display the next view.
- Tap the appropriate view icon in the lower-left corner of Date Book.

Working in Week view

Week view shows the calendar of your events for an entire week. This view lets you quickly review your appointments and available time slots. In addition, the graphical display helps you spot overlaps and conflicts in your schedule.

To display the Week view:

1. Tap the Week view icon.

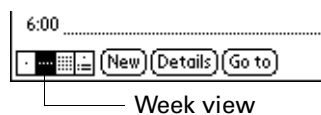

2. Tap the navigation controls to move forward or backward a week at a time, or tap on a column to display details of an event.

The Week view also shows untimed events and events that are before and after the range of times shown. Untimed repeating events appear in green.

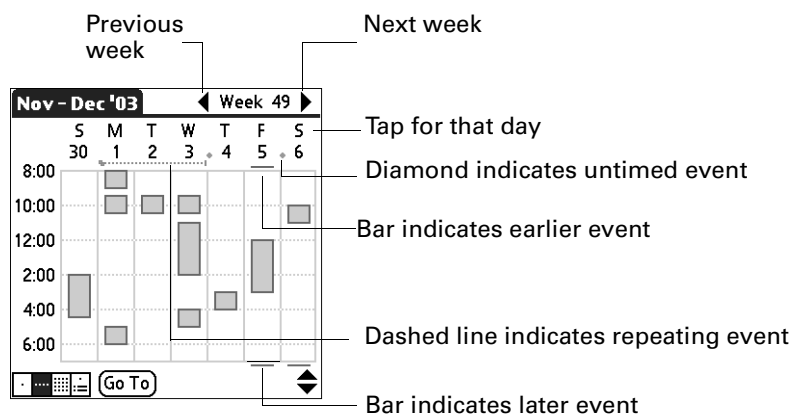

3. Tap an event to show a description of the event.

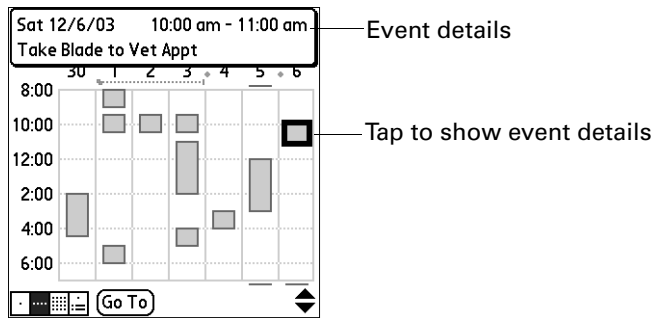

Tips for using Week view

Keep the following points in mind:

- To reschedule an event, tap and drag the event to a different time or day.
- Tap a blank time on any day to move to that day and have the time selected for a new event.
- Tap any day or date that appears at the top of the Week view to move directly to that day without selecting an event.
- Press Right and Left on the navigator to scroll to the next or previous week.
- Press Select on the navigator to insert the highlight, and then press Right and Left to select a day within the selected week. To view the events on the selected day, press Select on the navigator again.
- The Week view shows the time span defined by the Start Time and End Time in the Date Book Preferences settings. If you have an event before or after this time span, a bar appears at the top or bottom of that day's column. Use the onscreen scroll arrows to scroll to the event, or press Up and Down on the navigator to scroll to earlier and later time slots within the selected week.

Working in Month view

The Month view screen shows which days have events scheduled. Dots and lines in the Month view indicate events, repeating events, and untimed events.

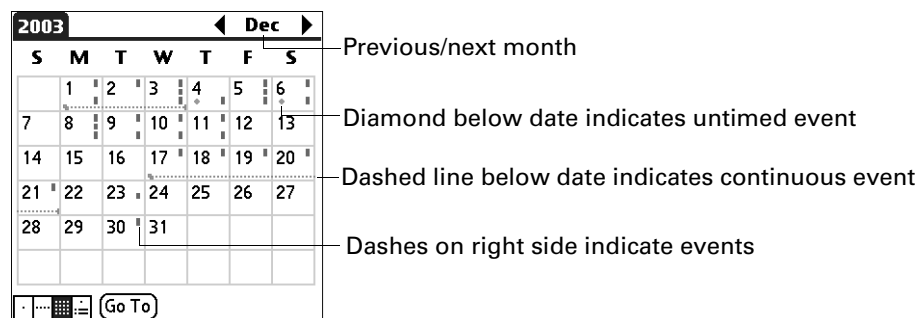

Month view button

You can control the dots and lines that appear in the Month view. See [“Display Options”](#) later in this chapter.

Tips for using Month view

Keep the following points in mind:

- Tap a day in the Month view to display that day in the Day view.
- Tap the scroll arrows in the upper-right corner, or press Left and Right on the navigator, to move forward or backward a month.
- Press Select on the navigator to insert the highlight, and then press Left and Right on the navigator to scroll to a specific day. Press Select on the navigator to display that day in the Day view.
- Untimed repeating events appear in green.

Working in Agenda view

The Agenda view shows you your untimed events, appointments, and To Do items in one screen. When you tap an untimed event or appointment in the Agenda view, the Day view appears so you can see more detailed information about the event. You can tap the check box next to a To Do item to mark it as completed. When you tap on a To Do item, your To Do list appears.

NOTE The To Do items that appear and how you can change them depends on the settings in your To Do preferences. See [“Setting To Do Preferences”](#) in [Chapter 16](#) for more information.

To display the Agenda view:

1. Tap the Agenda view icon.

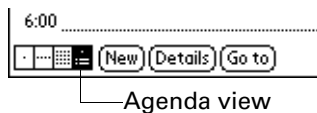

2. Tap the navigation controls to move forward or backward a day at a time, or to display more events and To Do items.

TIP You can also press Up and Down on the navigator to scroll through the events on the selected day, or press Right and Left on the navigator to scroll to the next or previous day.

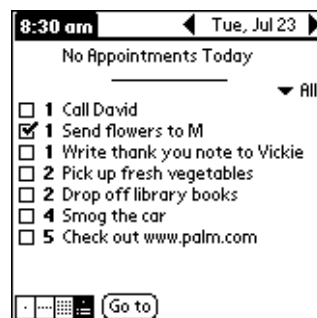
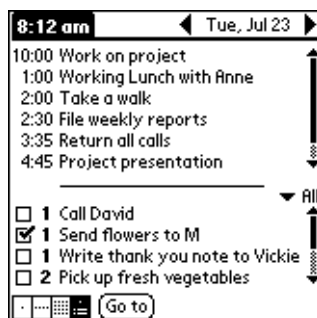

NOTE You can also change the category of To Do items shown. Tap on the pick list to choose another category. See [Chapter 16](#) for more information on working with To Do items.

Spotting event conflicts

With the ability to define specific start and end times for any event, it's possible to schedule events that overlap (an event that starts before a previous event finishes).

An event conflict (time overlap) appears in the Week View as overlapping bars. The first event created appears as a gray bar, and any subsequent conflicting events appear as a single red bar. The Day View displays overlapping red brackets to the left of the conflicting times. The Month View displays conflicting appointments in red.

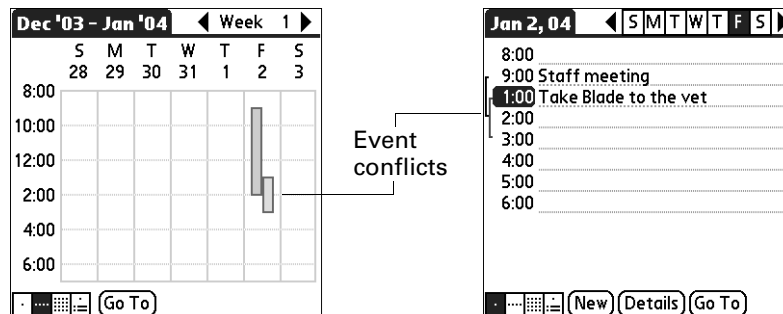

Date Book menus, preferences, and display options

Date Book menus are shown here for your reference, and Date Book features that are not explained elsewhere in this book are described here.

See “Using menus” in [Chapter 4](#) for information about choosing menu commands.

Record menu

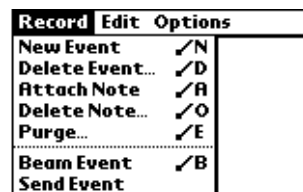

Send Event

Opens a dialog box where you can choose how you want to send the selected event to another device. The options available depend on the software installed on your handheld.

Options menu



Display Options

Allows you to change Date Book's appearance and which events are displayed.



- | | |
|----------------------------|--|
| Show Time Bars | Activates the time bars that appear in the Day view. The time bars show the duration of an event and illustrate event conflicts. |
| Compress Day view | Controls how times appear in the Day view. When Compress Day view is off, all time slots are displayed. When it is on, start and end times are displayed for each event, but blank time slots toward the bottom of the screen disappear to minimize scrolling. |
| Month view settings | These check boxes apply to the Month view of the Date Book. You can deactivate any or all of these settings to hide Timed, Untimed, or Daily Repeating events in the Month view <i>only</i> . |

Preferences



- Start/End Time** Defines the start and end times for Date Book screens. If the time slots you select do not fit on one screen, you can tap the scroll arrows  to scroll up and down.
- Alarm Preset** Automatically sets an alarm for each new event. The silent alarm for untimed events is defined by minutes, days, or hours before midnight at the end of the date of the event.
- Alarm Sound** Sets the tone of the alarm.
- Remind Me** Defines how many times the alarm occurs after the initial occurrence. The choices are Once, Twice, 3 Times, 5 Times, and 10 Times.
- Play Every** Defines how often the alarm sounds. The choices are Minute, 5 minutes, 10 minutes, and 30 minutes.

About Date Book

Shows version information for Date Book.

Using Expense



Expense enables you to keep track of your expenses and then transfer the information to a spreadsheet on your computer. In Expense you can do the following:

- Record dates, types of expenses, amount spent, payment method, and other details associated with any money that you spend.
- Assign expense items to categories so that you can organize and view them in logical groups.
- Keep track of vendors (companies) and people involved with each expense.
- Log miles traveled for a particular date or expense category.
- Sort your expenses by date or expense type.
- Send or export your expense information to popular computer applications, such as Microsoft Excel or Microsoft Word, using Palm™ Desktop software and HotSync® technology on a Windows computer.

IMPORTANT To access Expense, you must first perform a HotSync operation with your handheld. Expense is automatically loaded onto your handheld during the first HotSync operation.

To open Expense:

1. Press Home .
2. Select the Expense icon .

Expense		▼ All
4/4	Breakfast	\$ 23.00
4/4	Dinner	\$ 65.00
4/4	Hotel	\$ 88.33
4/4	Mileage	mi 366
4/4	Taxi	\$ 23.00
4/5	Business Meals	\$ 269.00

New Details... Show...

Adding expense items

A record in Expense is called an *item*. You can sort your Expense items into categories or add other information that you want to associate with the item.

1. Tap New.

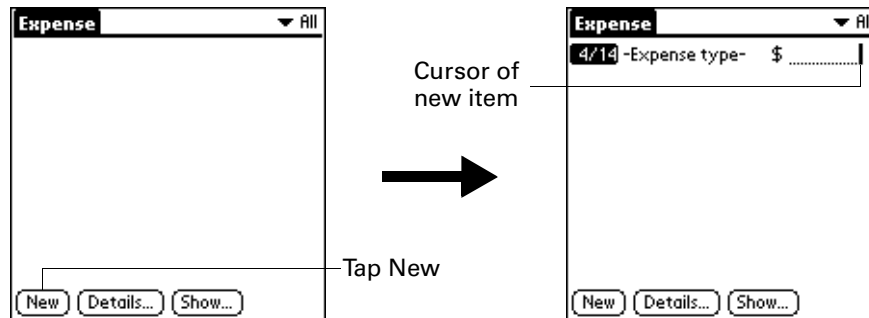

2. Enter the amount of the expense.
3. Tap the Expense type pick list and select a type from the list.

As soon as you select an expense type, your handheld saves your entry. If you do not select an expense type, it does not save the entry.

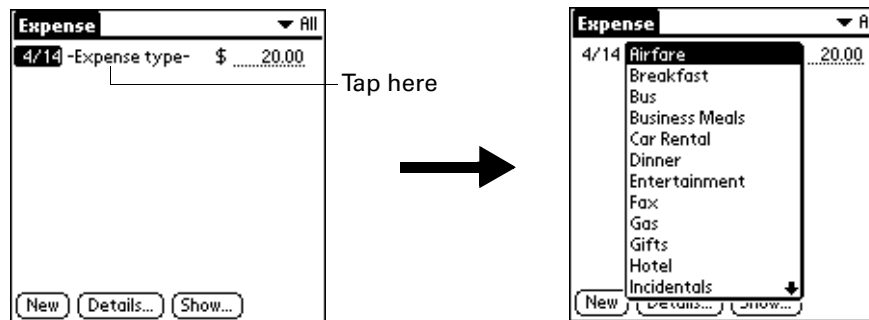

TIP Another quick way to create a new Expense item is to make sure that no Expense item is selected in the Expense list, type the first letter(s) of the expense type, and then type the numerical amount of the Expense item. This technique takes advantage of the automatic fill feature. See “Options menu” later in this chapter for details.

Changing the date of an Expense item

Initially, Expense items appear with the date on which you enter them. You can change the date associated with any Expense item.

To change the date of an Expense item:

1. Tap the Expense item you want to change.
2. Tap the date of the selected item.

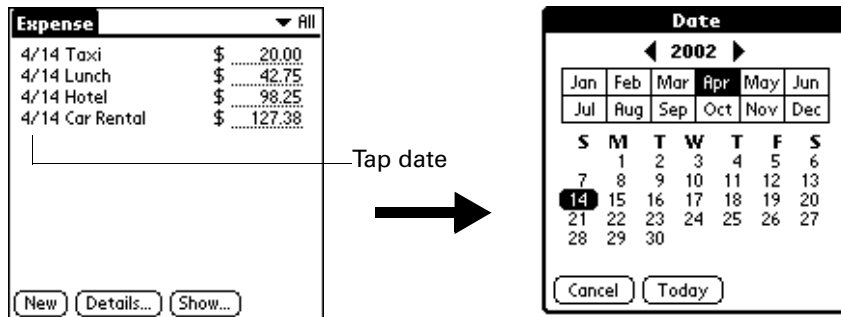

3. Tap the new date.

Entering receipt details

Expense provides a variety of options that you can associate with an item. These options appear in the Receipt Details dialog box.

To open the Receipt Details dialog box:

1. Tap the Expense item to which you want to assign details.
2. Tap Details.

The screenshot shows the Receipt Details dialog box with the following fields and options:

- Category:** ▼ Unfiled
- Type:** ▼ Lunch
- Payment:** ▼ Unfiled
- Currency:** ▼ \$
- Vendor:**
- City:**
- Attendees:** Who...

Buttons at the bottom: OK, Cancel, Delete, Note, and an upward arrow.

3. Select any of the following options:

Category Opens a pick list of system and user-defined categories. See [“Categorizing records”](#) in [Chapter 4](#) for more information.

Type Opens a pick list of expense types.

- Payment** Enables you to choose the payment method used to pay the Expense item. If the item is prepaid (such as airline tickets supplied by your company), you can choose Prepaid to place your expense in the appropriate company-paid cell of your printed expense report.
- Currency** Enables you to choose the type of currency used to pay the Expense item. The default currency unit is defined in the Preferences dialog box. You can also display up to four other common types of currency. See [“Customizing the Currency pick list”](#) later in this chapter for more information.
- Vendor and City** Enables you to record the name of the vendor (usually a company) associated with the expense and the city where the expense was incurred. For example, a business lunch might be at Rosie’s Cafe (Vendor) in San Francisco (City).
- Attendees** See [“Looking up names to add to Expense records”](#) in Chapter 4 for more information.

4. Press Function  + Enter  or tap OK.





Customizing the Currency pick list

You can select the currencies and symbols that appear in the Currency pick list.

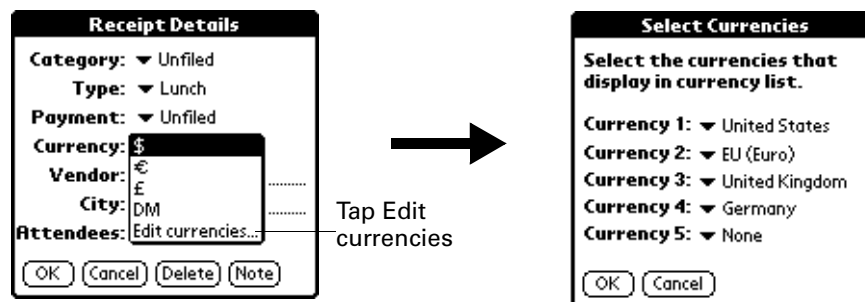
To customize the Currency pick list:

1. Tap the Currency pick list in the Receipt Details dialog box, and then select Edit currencies.





2. Tap each Currency pick list and select the country whose currency you want to display on that line.
3. Press Function  + Enter  or tap OK to close the Select Currencies dialog box.
4. Press Function  + Enter  or tap OK.

Changing the default currency

You can select which currency appears by default when you're entering Expense items. You can override this setting when entering individual expense items.

To change your default currency:

1. Open Expense.
2. Press Command Stroke  + R.
Alternately, press Function  + Menu , and then select Preferences on the Options menu.
3. Tap the Default Currency pick list.
4. Select the currency symbol that you want to appear in Expense.

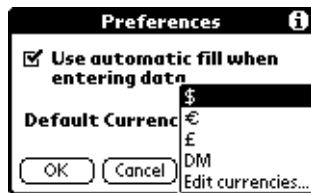



5. Press Function  + Enter  or tap OK.

Defining a custom currency symbol

If the currency you want to use is not in the list of countries, you can create your own custom country and currency symbol.



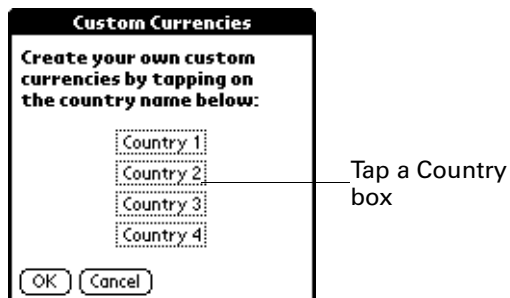

To define a custom currency symbol:

1. Press Command Stroke  + Y.
Alternately, press Function , and then select Custom Currencies on the Options menu.
2. Tap one of the four Country boxes.



3. Enter the name of the country and the symbol that you want to appear in Expense.



4. Press Function  + Enter  or tap OK to close the Currency Properties dialog box.
5. Press Function  + Enter  or tap OK.

NOTE If you want to use your custom currency symbol as the default for all Expense items, select the symbol in the Preferences dialog box. If you want to use your custom currency symbol only for a particular Expense item, select the symbol in the Receipt Details dialog box associated with that item.

Setting Show Options

Show Options defines the sort order and other settings that relate to your Expense items.

To open the Show Options dialog box:

1. In the Expense list, tap Show.
2. Select any of the options.

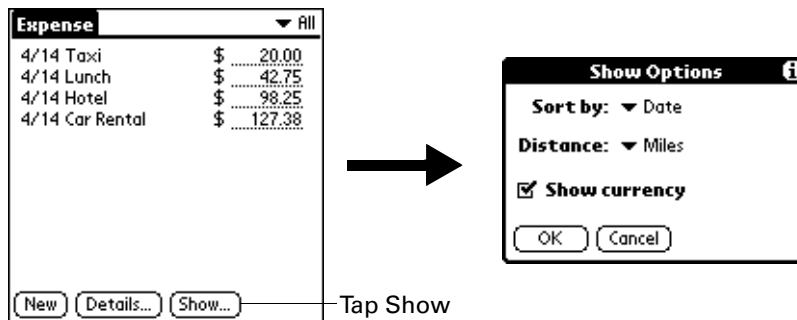

- Sort by** Enables you to sort expense items by date or type.
- Distance** Enables you to display Mileage entries in miles or kilometers.
- Show currency** Shows or hides the currency symbol in the Expense list.

3. Press Function  + Enter  or tap OK.

Working with Expense data on your computer

After you enter your expenses into the Expense application on your handheld and perform a HotSync operation, Palm Desktop software enables you to do any of the following on your computer. See the Palm Desktop software online help for details. This feature is not available on Mac computers.

- Add, modify, and delete your Expense data.
- Organize your Expense data by category, amount, date, type, or notes.
- View Expense data in various formats: List, Large Icons, or Small Icons.
- Record individual expenses in various currencies and display the total in one selected currency type.
- Print Expense reports.
- Transfer Expense data to other applications, such as Microsoft Excel, using the Send command or Export command, and import data in popular file formats.

Displaying the euro on your computer

When you perform a HotSync operation, the euro symbol is transferred to Palm Desktop software like any other piece of data on your handheld. The symbol appears in Palm Desktop software, however, only if you are using fonts that support the euro symbol.

These fonts are part of the operating system on your computer. They do not reside with your Desktop application, and they are not produced by Palm, Inc. For more information refer to the documentation that accompanies your desktop computer's operating system.

Printing the euro

Even with operating system support, problems may arise when you print documents that contain the euro. When a font is present on both the printer and the computer, the printer font is used by default to increase printing speed. If the printer font does not include the euro, a box is printed instead of the euro symbol.

These fonts are part of the operating system on your computer. They do not reside with your Desktop application, and they are not produced by Palm, Inc. For more information, refer to the documentation that accompanies your desktop computer's operating system.

Using Expense menus

Expense menus are shown here for your reference, and Expense features that are not explained elsewhere in this book are described here.

See “Using menus” in [Chapter 4](#) for information about choosing menu commands.

Record menu

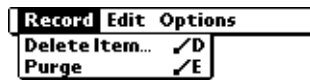

Options menu



Preferences Opens the Preferences dialog box where you can select automatic fill and default currency options.

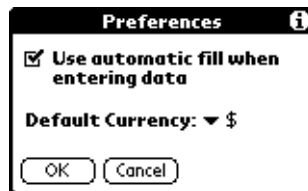

Use automatic fill. Enables you to select an expense type by typing the first letter of an expense type. For example, if you type the letter *T*, it enters the “Taxi” expense type. Typing *T* and then *E* enters *Telephone*, which is the first expense type beginning with the letters *TE*.

About Expense Shows version information for Expense.

Using Memo Pad

 Memo Pad provides a place to take notes that are not associated with records in Date Book, Address Book, or To Do List. The number of memos you can store is dependent only on the memory available on your handheld. Use Memo Pad to do the following:

- Send memos to popular computer applications like Microsoft Word when you synchronize using Palm™ Desktop software and HotSync® technology.
- Assign memos to categories so that you can organize and view them in logical groups.
- Write down phone numbers and other types of information that you can later copy and paste into other applications.

To open Memo Pad:

1. Press Home .
2. Tap the Memo Pad icon .

Creating memos



A record in Memo Pad is called a *memo*. You can assign memos to categories and mark them private as described in [Chapter 4](#). This section covers how to create a memo.

To create a new memo:

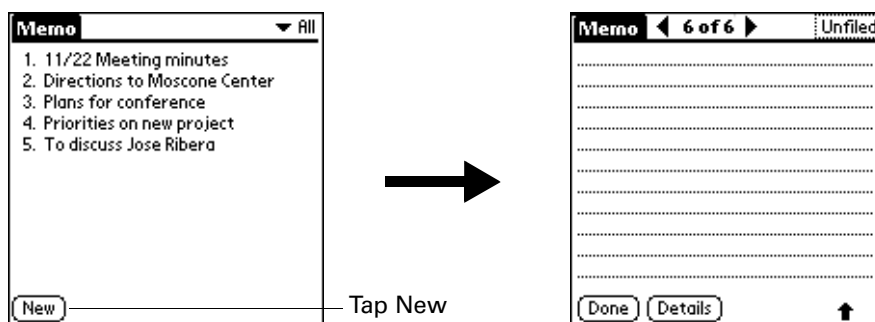
1. Open Memo Pad.
2. Tap New.



TIP In the Memo list screen, you can also begin typing to create a new memo. The first letter is automatically capitalized and begins your new memo. If you have a memo open, you can press Command Stroke  + N.

3. Enter the text that you want to appear in the memo.
4. Press Function  + Enter , or tap Done.

Reviewing memos



The first line of a memo appears in the Memo list. This makes it easy to locate and review your memos.

To review a memo:

1. In the Memo list, select the text of the memo.

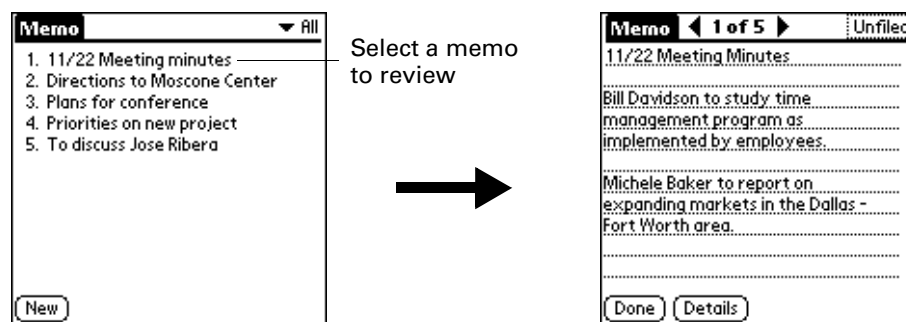
TIP You can also select, review, and move between memos with the navigator. See [“Using the navigator”](#) in [Chapter 3](#) for details.



2. Review or edit the text in the memo.
3. Press Function  + Enter , or tap Done.

Using Memo Pad menus

Memo Pad menus are shown here for your reference, and Memo Pad features that are not explained elsewhere in this book are described here.

See [“Using menus”](#) in [Chapter 4](#) for information about choosing menu commands.

The Record and Options menus differ depending on whether you’re displaying the Memo list or an individual memo.

Record menus

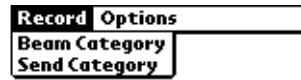

Memo list

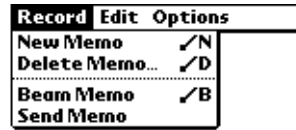

Memo screen

Send Category Opens a dialog box where you can choose how to send all records in the selected category to another device. The options available depend on the software installed on your handheld.

Send Memo Opens a dialog box where you can choose how to send the selected memo to another device. The options available depend on the software installed on your handheld.

Options menus



Memo list



Memo screen

Preferences Displays the Memo Preferences dialog box, where you define the sort order for memos.

About Memo Pad Shows version information for Memo Pad.

Using Palm™ Mobile



Palm™ Mobile is a fast and simple way to use your handheld to make and receive calls. The Mobile features differ depending on your wireless service provider. Use Palm Mobile to do the following:

- Dial a number in a multitude of ways, such as from the keypad, or by using speed dial, call history, or your Address Book.
- Answer a second call while automatically placing the current caller on hold.
- Retrieve voicemail.
- Make and manage a conference call.
- Retrieve Caller ID information from your Address Book.
- View a history list of your last 20 missed, incoming, and received calls.
- Create call reminders to help you follow up on calls.
- Quickly access a list of frequently called numbers.
- Attach notes to the Address Book entry of the person you are speaking with.

NOTE The Mobile features available on your handheld depend on your contract with your wireless service provider.

IMPORTANT Whenever you use the wireless features of your handheld, please observe the guidelines or prohibitions on the use of wireless devices in your current location. For example, when you are on an airplane, do not turn on your radio at times when government or airline regulations prohibit the use of cellular phones. You can, of course, use all other applications of your handheld in accordance with airline regulations for electronic devices.

Using your hands-free headset

Your handheld functions as a mobile phone using a hands-free headset. The headset enables you to answer and end calls.

The headset cable connects to the jack at the upper-left of the handheld. Once the jack is connected and the earpiece speaker is placed in your ear, you can answer and end calls by using the button on the headset microphone.

The button on the headset microphone changes function according to the call status:

Mobile radio off or Mobile radio on—no calls **Short press:** Opens Palm Mobile and cycles through screens.
Long press: Continuous cycling through Palm Mobile screens.

Mobile radio on—phone ringing **Short press:** Answers call.
Long press: Ignores the call and sends the call to voicemail.

Mobile radio on—active call in session **Short press:** If you are currently in another application, returns you to Palm Mobile Active Call screen. If you are in Palm Mobile, cycles to the next application screen.
Long press: Ends currently active call.

Mobile radio on—active call in session and phone is ringing **Short press:** If you are currently in another application, returns you to Palm Mobile Active Call screen. If you are in Palm Mobile, cycles to the next application screen.
Long press: Ignores the call and sends the call to voicemail.

To use the hands-free headset:

1. Insert the headset connector into the voice jack.

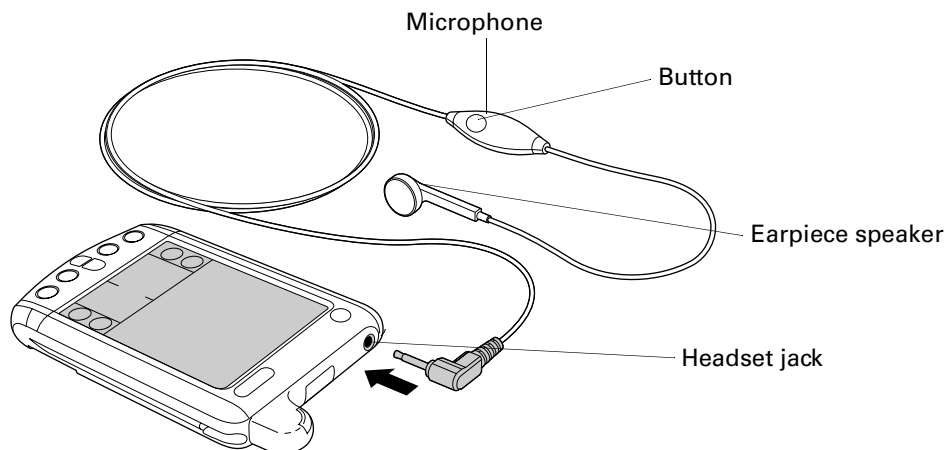

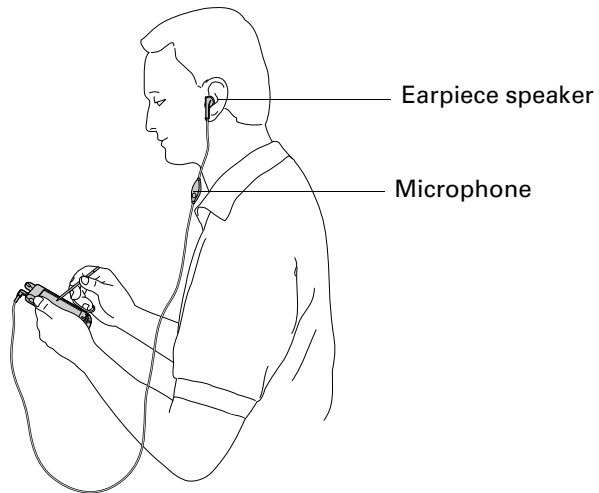

2. Place the earpiece speaker comfortably in your ear.





When you have an active call, you can adjust the speaker volume on your headset using the Volume dialog box.

To adjust the volume during an active call:

1. Perform one of the following:
 - Press Function  + Menu , and then select Volume.
 - When a call is active, press Up or Down on the navigator.
2. When the Headset Volume screen appears, adjust the volume using the slider or navigator.





3. Press Function  + Enter , or tap Done.

Opening Palm Mobile

You can open Palm Mobile from the Applications Launcher or from the headset.

NOTE The Mobile features available on your handheld depend on your contract with your wireless service provider. Some wireless service providers require a PIN to turn on the mobile radio. Check with your wireless service provider for more information.

To open Palm Mobile from the Mobile icon in Applications Launcher:

1. Press the Home .
2. Tap the Palm Mobile icon .

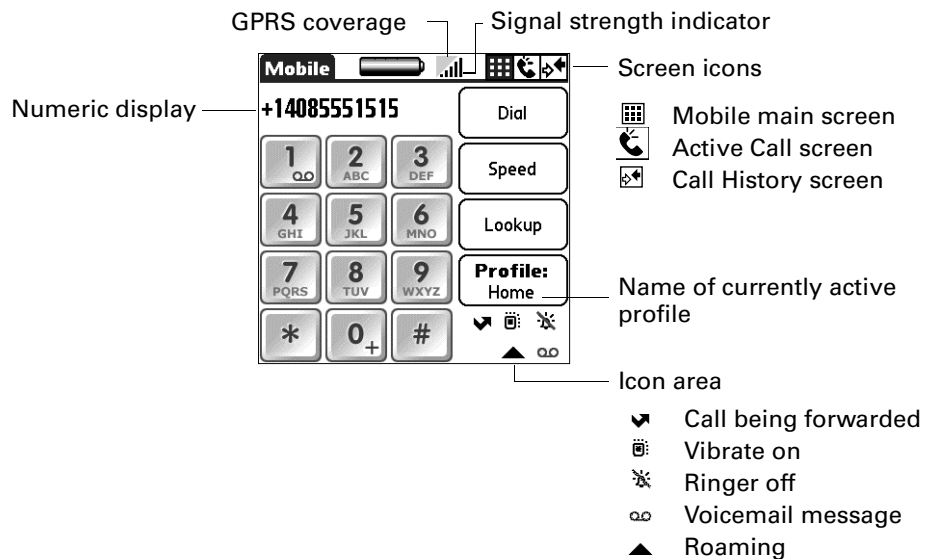

To open Palm Mobile from the headset:

- If the headset is not plugged in, insert the headset plug into the headset jack on your handheld.

The Palm Mobile application automatically opens. If the mobile radio is not on, the mobile radio automatically turns on.

- If the headset is already plugged in, press the button on the headset.

See [“Using your hands-free headset”](#) earlier in this chapter for more information on using the headset button.

Answering a phone call

When you receive a call, a notification message is displayed with any caller information that is available.

To answer a phone call:

1. Do one of the following:
 - If your headset is not plugged in, insert the headset plug into the voice jack on your handheld and place the speaker in your ear. Palm Mobile automatically opens and answers the phone call.
 - If your headset is plugged in when the call notification arrives, tap Answer.

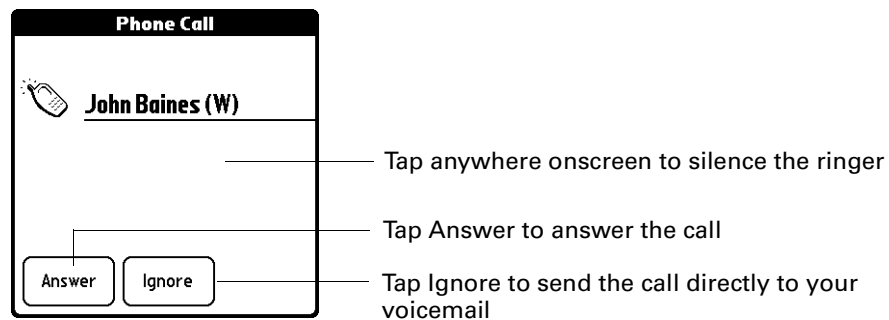

2. Begin communicating.

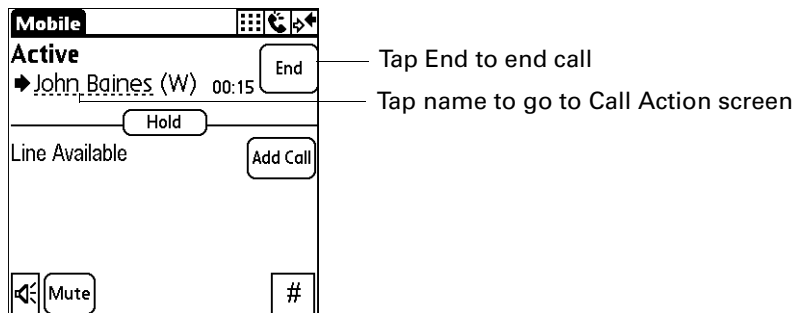

Dialing a number from the keypad

You can dial a number using the keypad the same as you would using a mobile phone.

To dial a number from the keypad:

1. Tap the telephone number on the keypad.

TIP You can also enter the telephone number using your keyboard.

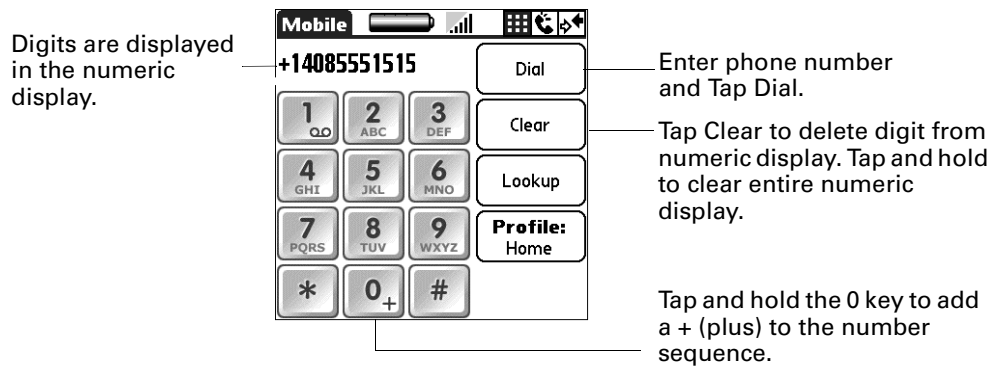

2. Tap Dial.

The number is dialed and added to the Call History list. You are ready to communicate.

Redialing the most recently dialed number

You can quickly redial the most recently dialed number.

To redial the most recently dialed number:

1. Tap Dial when the numeric display has no digits.

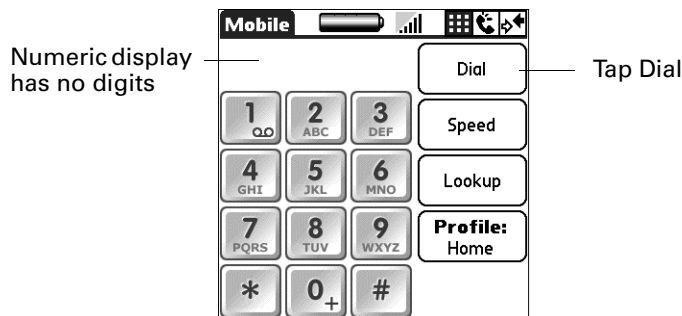

2. Tap Dial.

The number is dialed and added to the Call History list. You are now ready to communicate.

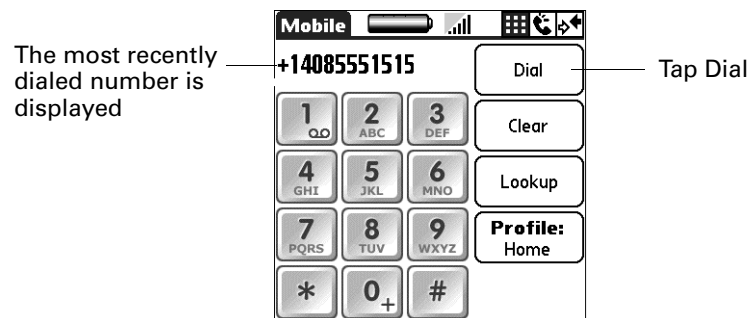

TIP If you need to enter digits during the phone call to access voicemail or an automated phone-answering system, press the Keypad icon and use the on-screen keypad to enter the digits. Also, you can enter the numbers or characters from the keyboard.

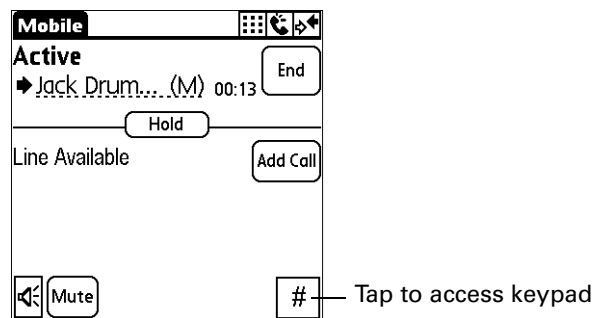

Managing a phone call

When the phone call is answered or when you place a call, the Active Call screen is displayed. If you select the name or number, you go to the Call Action screen where you can do the following:

- Save the number to the Address Book.
- Add an Address Book note.
- Set a redial reminder.
- Disconnect the call.

To manage a phone call:

1. Tap the name.
2. Tap the appropriate button.

Number not found in Address Book

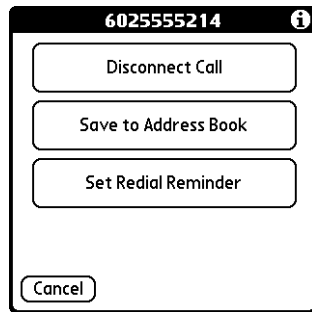

Number in Address Book

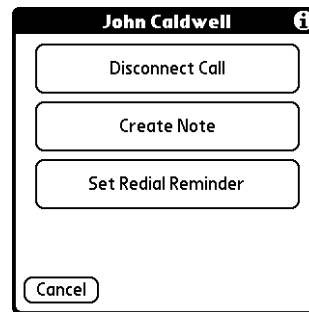

You can use any of the following features:

- Disconnect call** Disconnects only the current selected call, not the calls on hold.
- Save to Address Book** Opens the Save to Address Book screen. The Save to Address Book button changes to Create Note if the number was found in your Address Book when the call was received or placed.
- Create note** Attaches a note to the Address Book entry.
- Set Redial Reminder** Opens the Set Redial Reminder dialog box. See [“Creating a redial reminder”](#) later in this chapter.

Answering call waiting

If you receive a call while you are on the line with another caller, you can place the current caller on hold and answer the other call. You can also ignore the call and allow it to go to voicemail.

To answer call waiting:

- Tap Answer.

The original caller is put on hold, and the new caller becomes the active caller.

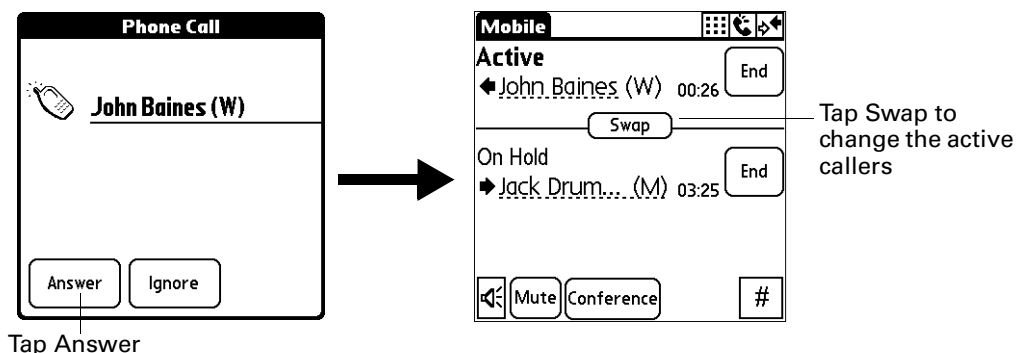

Using conference calling

Conference calling enables you to have from two to five active callers conversing together.

NOTE The Mobile features available on your handheld depend on your contract with your wireless service provider.

Creating a conference call

You can create a conference call by conferencing the current callers, or you can dial and add callers.

To create a conference call with an active caller and callers on hold:

- Tap Conference.

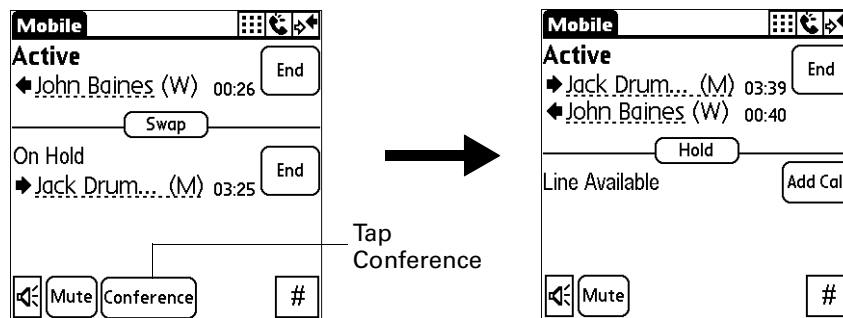

To place a conference call:

1. Tap Add Call.

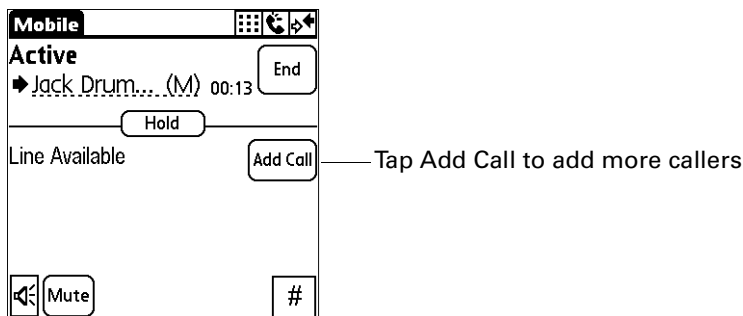

2. Enter the number and tap Dial.

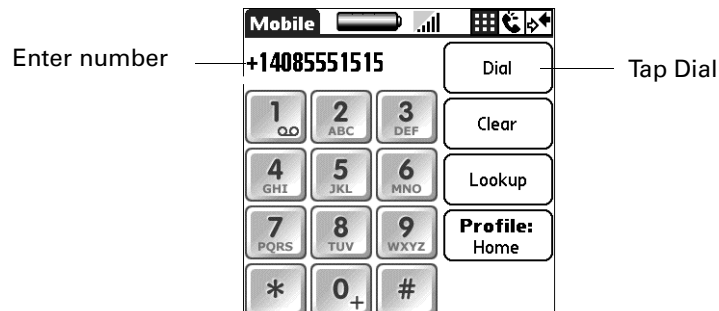

- Once the number appears as the Active caller, tap Conference.

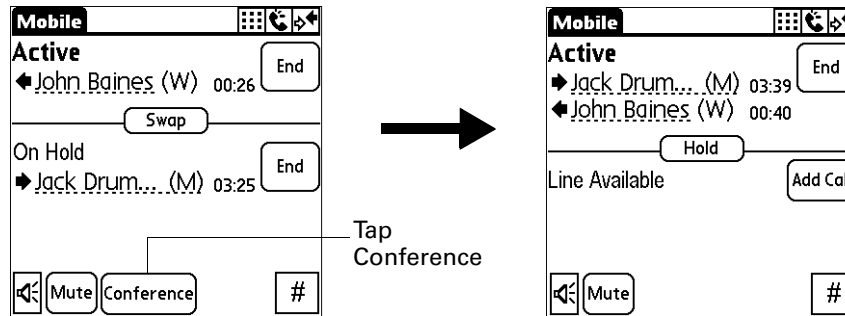

Managing a conference call

Palm Mobile enables you to manage all parts of a conference call. You can do the following:

- Have a private conversation with one of the callers while the other callers are put on hold
- Mute the microphone on your earbud cable
- Disconnect one participant from the conference call
- Disconnect all participants from the conference call

To have a private conversation with one caller:

- Tap name.

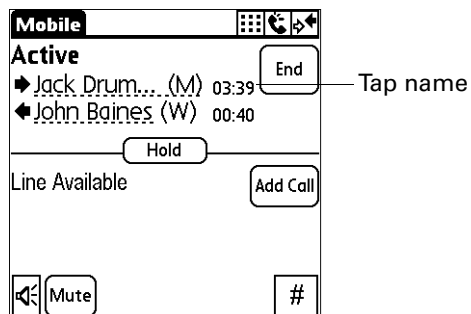

2. Tap Private Conversation.

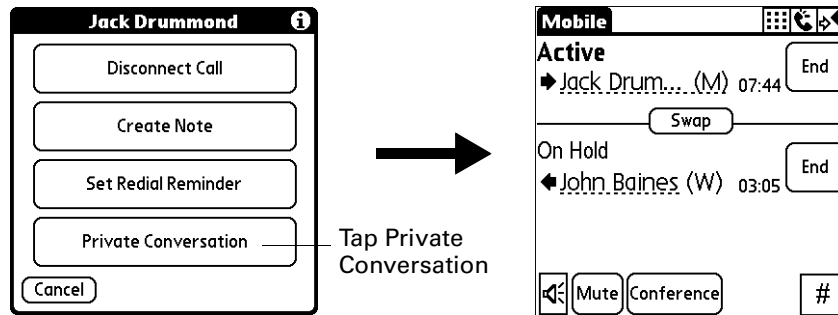

3. Tap Conference to end the private conversation and return to the conference call.

To disconnect one caller:

1. Tap name.

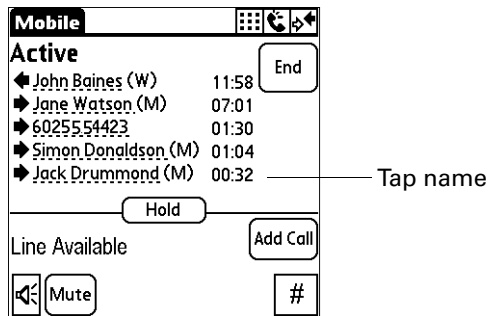

2. Tap Disconnect Call.

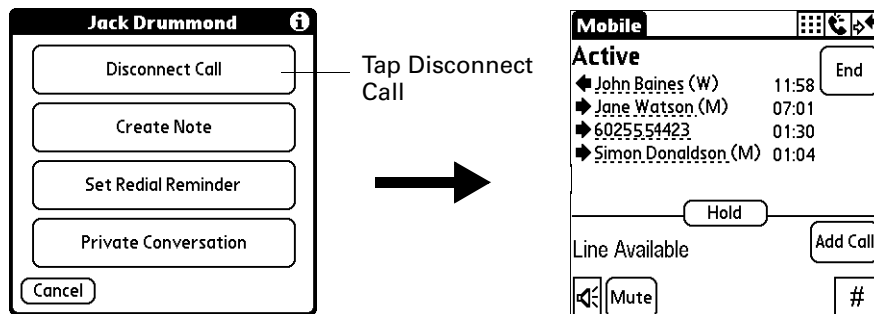

To add a caller to a current conference call:

1. Tap Add Call.

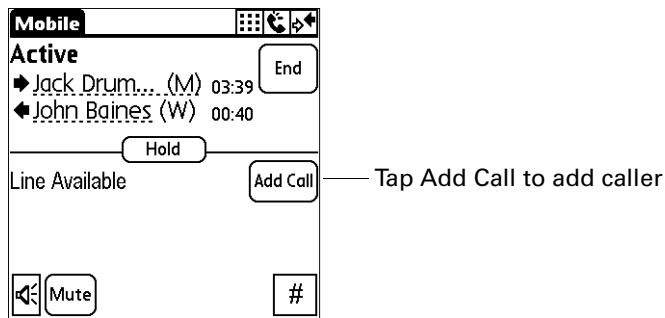

2. Enter the number and tap Dial.
3. Once the number appears as the Active caller, tap Conference to add callers on hold.

To end the conference call:

- Tap End.

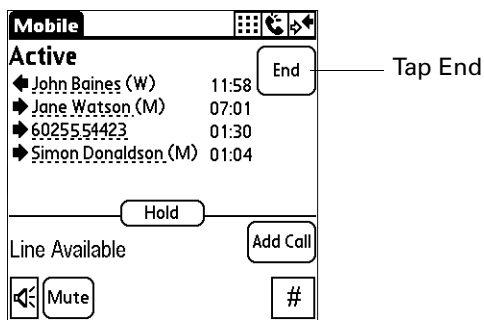

To mute the conference call:

- Tap Mute.

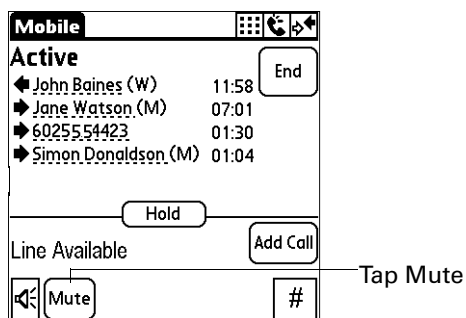

Retrieving voicemail

NOTE Your wireless service provider determines your voicemail properties, such as mailbox size, the number of rings before diverting a call to voicemail, and how to record your voicemail message. Contact your wireless service provider for information on setting up your voicemail.

When a voicemail message is waiting, a notification message is displayed. You can retrieve your voicemail messages directly from the notification message or from the Palm Mobile application. Your voicemail access number is configured in the Mobile preferences screen. See [“Keyboard Preferences”](#) in [Chapter 21](#) for more information.

To retrieve voicemail from a notification message:

- Tap Go To.

Your voicemail number is dialed.

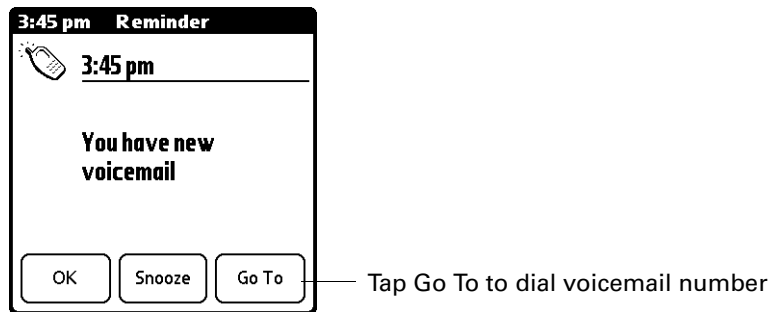

To retrieve voicemail message from Palm Mobile:

- Press and hold the 1 key.

Your voicemail number is dialed.

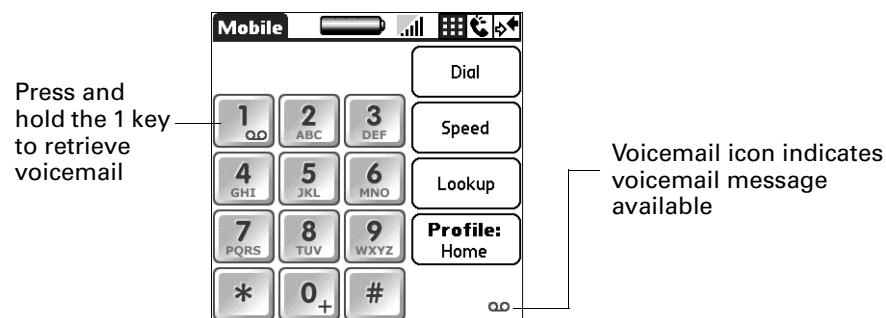

TIP If you need to enter digits during the phone call to access voicemail or an automated phone answering system, press the Keypad icon and use the on-screen keypad to enter the digits. Also, you can enter the numbers or characters from the keyboard.

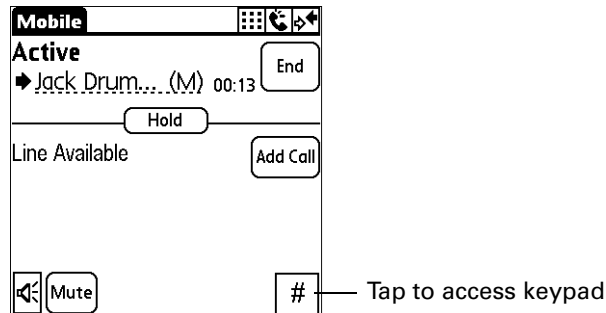

Using speed dial

Speed-dialing enables you to quickly dial your most commonly used numbers. The three speed-dial categories enable you to save 24 numbers.

Creating a speed-dial entry

You can use your Address Book to create a speed-dial entry.

To create a speed dial entry:

1. Tap Speed.

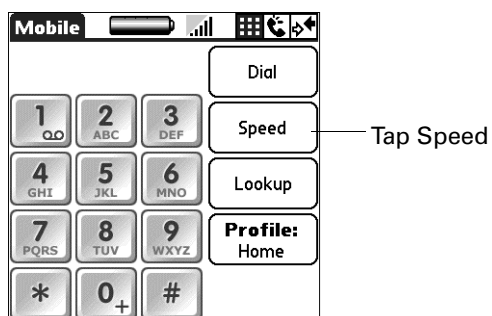

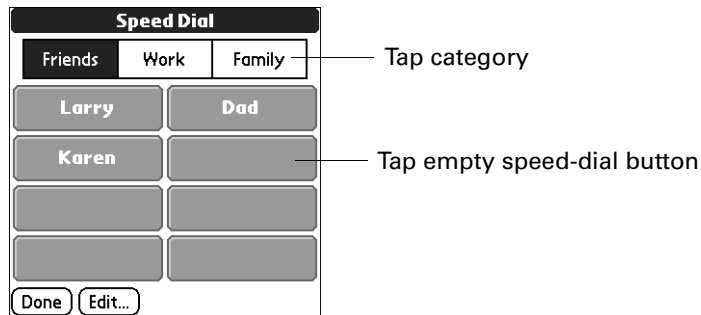

2. Tap a category and then tap an empty speed-dial button.

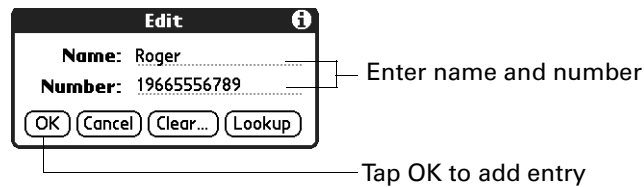

3. Enter a name and telephone number.

You can type the letter “p” or a comma (,) to add a two second pause.



4. Press Function  + Enter , or tap OK.

The name appears on the speed-dial button.

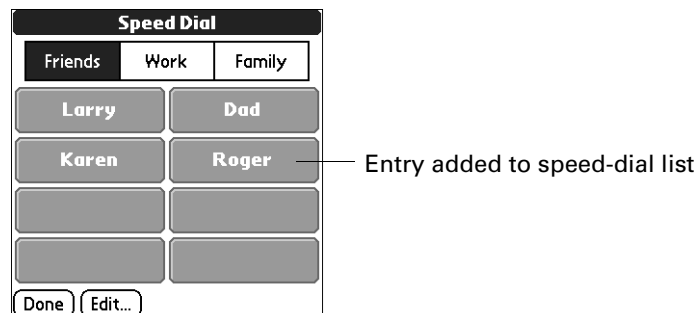

5. Tap Done.

Dialing a speed-dial entry

Before you can dial speed-dial entries, you must create them. For information on creating speed-dial entries, see [“Creating a speed-dial entry”](#) earlier in this chapter.

To dial a speed-dial entry:

1. Tap Speed.

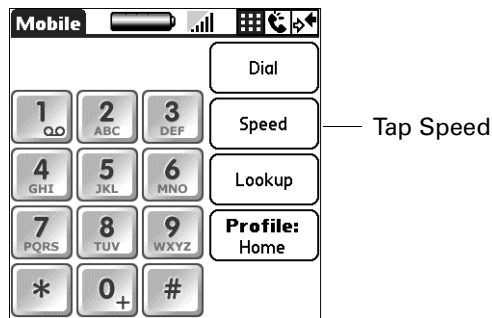

2. Tap a category and then tap one of the speed-dial buttons.

The number is dialed and added to the Call History list. You are now ready to communicate.

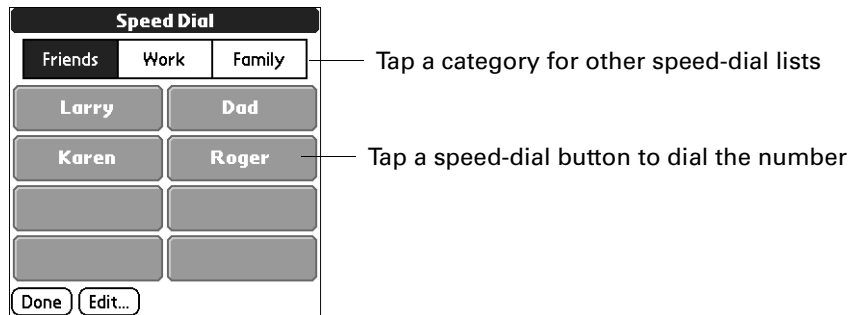

Editing a speed-dial entry

To edit a speed-dial entry:

1. Tap Speed.

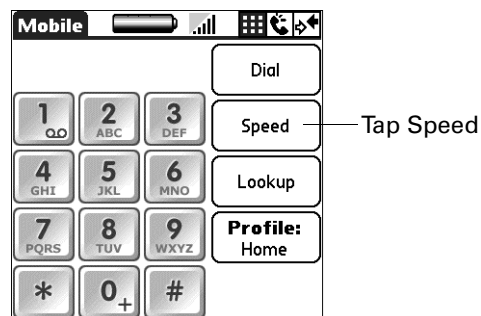

2. Tap Edit.

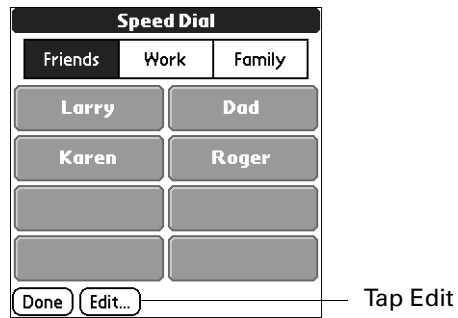

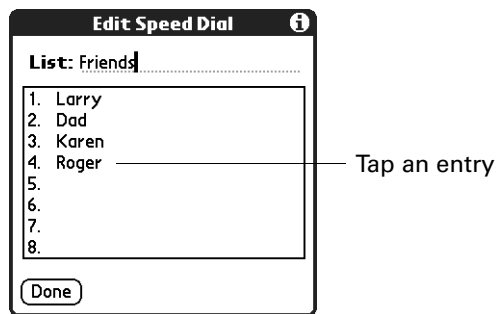

3. Tap an entry.

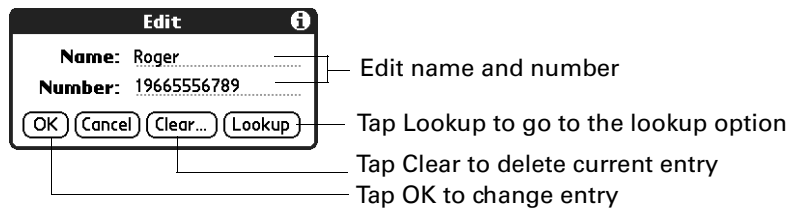

4. Edit the entry.



5. Press Function  + Enter , or tap OK.

Using the Call History list

Your handheld keeps a list of 20 of the most recently dialed numbers. If the number is an Address Book entry, the name from the Address Book entry appears in the Call History list.

You can also add an entry from Call History to your Address Book.

Dialing a number from the Call History list

You can dial a number using the Call History list.

To dial a number from the Call History list:

1. Tap the Call History icon .

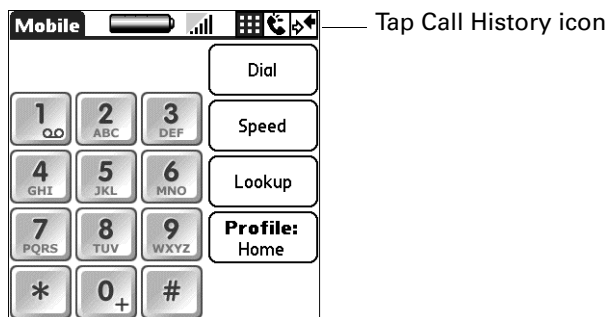

2. Tap an entry from the list.

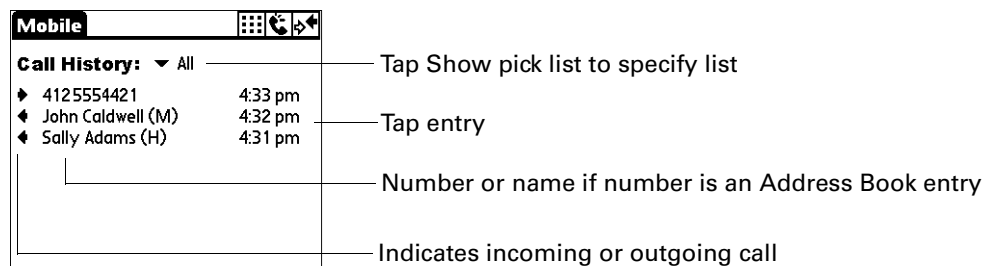

3. Tap Call.

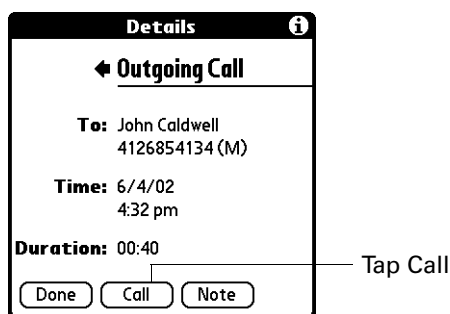

Using redial reminders

A redial reminder notifies you of an appointment you set to make a call. The reminder gives you the standard option to make the call, snooze, or go to the Reminders menu.

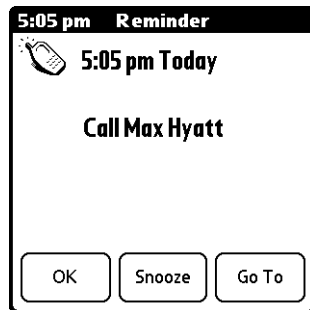

Creating a redial reminder

You can create a redial reminder from the Call Actions screen and from the Mobile dialog box.

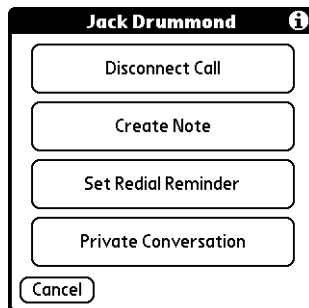

To create a redial reminder:

1. Tap Set Reminder or Set Redial Reminder.

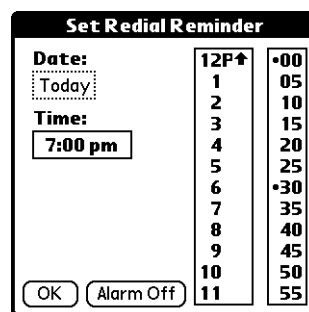

2. Set the date, time, and alarm.





3. Press Function  + Enter , or tap OK.

Managing redial reminders

You can view and edit your redial reminders.

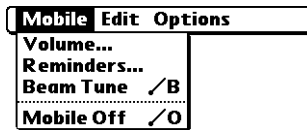

To view and edit the redial reminder list:

1. Press Function  + Menu .

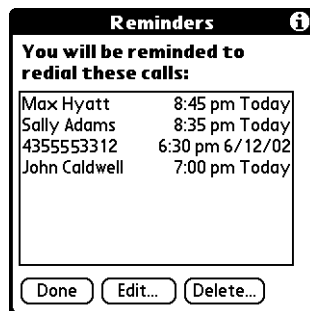

2. Select Reminders.
3. Edit your redial reminders.



4. Press Function  + Enter , or tap Done.

Managing profiles

The phone profiles store settings for call diverting and the ringer. You can set up to six profiles.

To change your currently active call profile:

1. Tap Profile.

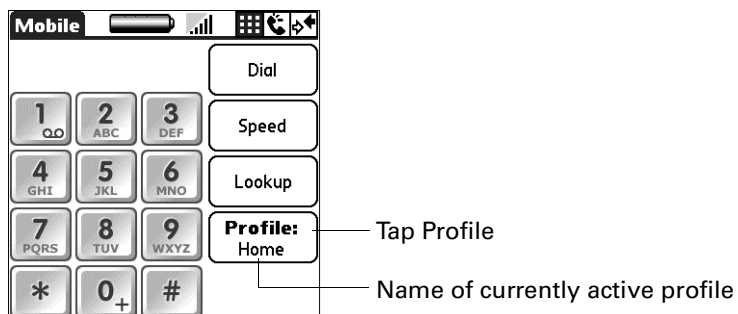

2. Tap one of the profiles.

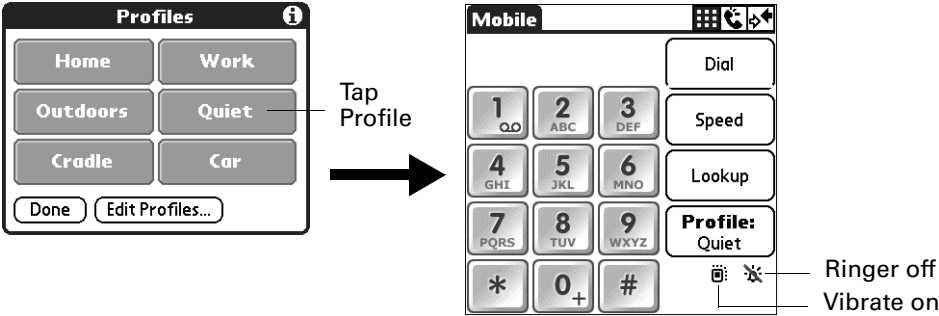

To edit your call profiles:

1. Tap Profile.



2. Tap Edit Profiles.

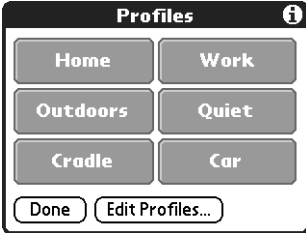

3. Tap a profile.

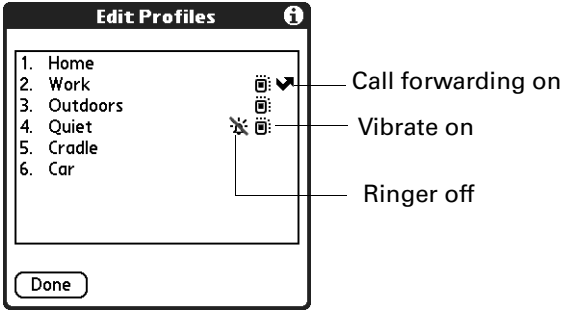



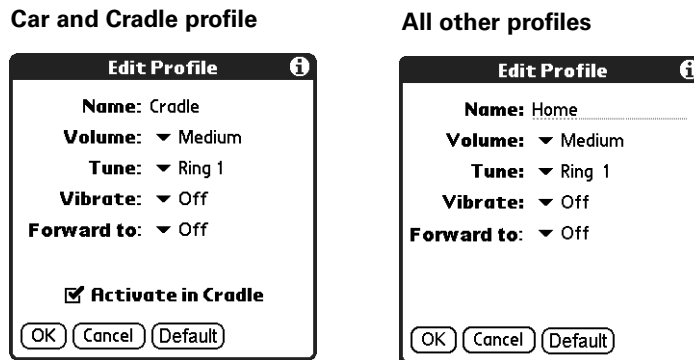

4. Edit the profile.



You can edit the following settings:

Name	The name of your profile. Car and Cradle profile names cannot be changed.
Volume	Adjusts the volume level or turns off the ringer.
Tune	Sets the tune of the ringer. There are multiple tunes and ring styles to choose from. When you make a selection, the tune plays.
Vibrate	Sets the vibrator option to on, off, or vibrate then ring.
Forward to	Sets the call forwarding option to off, forward to voicemail, or other. If you select other, a field appears where you can enter the phone number you want to forward the call to.
Activate in Cradle	Car and Cradle profiles only: Auto-activates the profile when the handheld is placed in the cradle. When the handheld is removed from the cradle, the original profile is restored.
Default	Changes the options to the default settings in each list.

5. Press Function  + Enter , or tap OK.
6. Press Function  + Enter , or tap Done.

Managing ring tunes

You can choose a ringer tune from a tune list for each of your profiles (see [“Managing profiles”](#) earlier in this chapter). You can manage the list of available tunes from the Select Tune screen by deleting tunes and beaming tunes to other devices. You can also receive tunes beamed from other devices. For more information on receiving beamed information, see [“Using elements of the handheld interface”](#) in [Chapter 3](#).

NOTE You can receive Nokia ring tones, but you cannot send them to another device.

To delete a ring tone:

1. Press Command Stroke (⌘) + B.

Alternately, press Function (F) + Menu (⌘), and then select Beam Tune from the Mobile list.

2. Tap a ring tune.

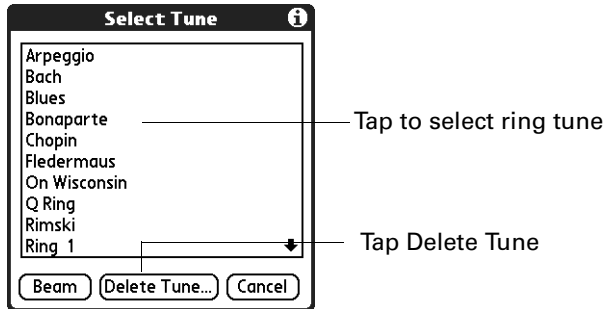

3. Tap Delete Tune.

4. Tap Delete.

To beam a ring tune:

1. Press Command Stroke (⌘) + B.

Press Function (F) + Menu (⌘), and then select Beam Tune from the Mobile list.

2. Tap a ring tune.

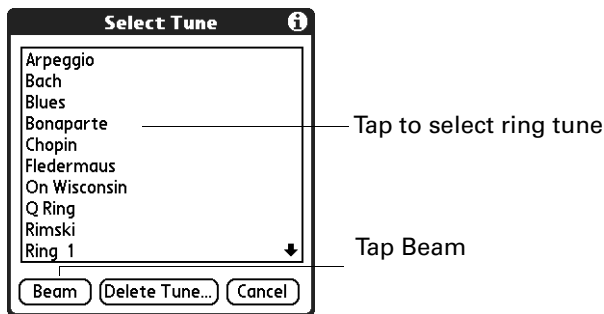

3. Tap Beam.

Using Palm Mobile menus

The Palm Mobile menus are shown here for your reference, and menu features that are not explained elsewhere in this book are described here.

See “Using menus” in [Chapter 4](#) for information about choosing menu commands.

Mobile menu

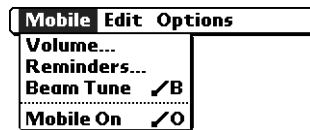

Mobile On Turns the mobile radio on or off.
Mobile Off

Options menu

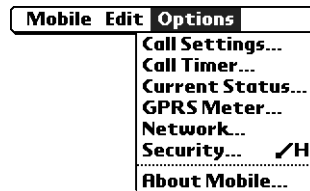

- Call Settings** Opens the Call Settings preferences screen where you can do the following:
- Set call waiting. See “[Enabling call waiting](#)” in [Chapter 21](#).
 - Conceal your number. See “[Concealing your number](#)” in [Chapter 21](#).
 - Divert your calls. See “[Diverting your calls](#)” in [Chapter 21](#).
- Call Timer** Opens the Call Timer preferences screen where you can track your phone time. See “[Tracking your phone time](#)” in [Chapter 21](#).
- Current Status** Opens the Current Status preferences screen where you can check the status of your connection. See “[Checking your current status](#)” in [Chapter 21](#).
- GPRS Meter** Opens the GPRS preferences screen where you can check the status of your connection. See “[Checking your GPRS network usage](#)” in [Chapter 21](#).

Network	<p>Opens the Network preferences screen where you can do the following:</p> <ul style="list-style-type: none">■ Customize your list of network carriers. See “Setting your network selection search mode” in Chapter 21.■ View and customize your preferred network list. See “Viewing and editing your preferred networks list” in Chapter 21.
Security	<p>Opens the Security preferences screen where you can do the following:</p> <ul style="list-style-type: none">■ Lock your mobile radio until a valid PIN code is entered. See “Setting PIN for mobile power on” in Chapter 21.■ Bar or block different classes of incoming and outgoing calls. See “Setting call barring” in Chapter 21.■ Set Fixed Number Dialing (FND) so that only pre-programmed phone numbers in the FND phone book can be dialed. See “Setting Fixed Number Dialing (FND)” in Chapter 21.
About Mobile	<p>Shows version information for Palm Mobile.</p>



Using Note Pad



Note Pad provides a place to take notes in your own handwriting. You can use Note Pad to do everything you might do with a piece of paper and a pencil. Use Note Pad to do the following:

- Take notes, draw a sketch, or write any kind of message directly on your handheld screen. Later, you can enter this information into other applications.
- Set an alarm to use your notes as reminder messages.
- Assign notes to categories so that you can organize and view them in logical groups.
- Exchange notes with other devices that have Note Pad 2.0 installed and that use SMS.
- Use Palm™ Desktop software and HotSync® technology to copy and paste notes into popular computer applications like Microsoft Word, or to send notes as e-mail attachments.

To open Note Pad:

1. Press Home .
2. Select the Note Pad icon .

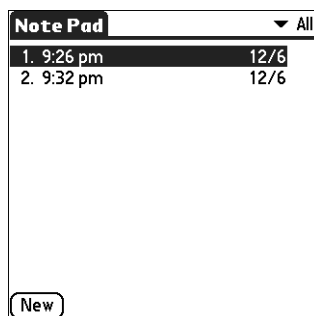

Creating a note

A record in Note Pad is called a *note*. You can assign notes to categories and mark them private as described in [Chapter 4](#). This section covers how to create a note.

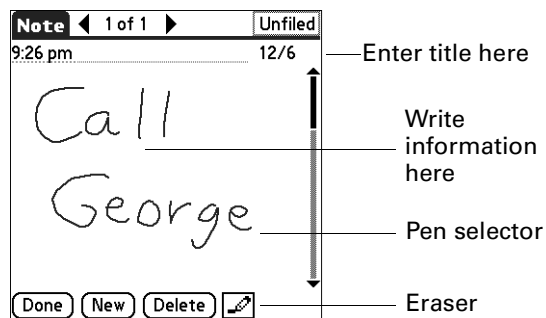

To create a new note:

1. Tap New.





2. Write the information directly on the handheld screen.

Tap the pen selector to select a different pen width, or select the eraser to remove unwanted strokes.

3. Press Function  + Enter , or tap Done.

To clear the screen:

1. Press Function  + Menu .
2. Select Edit, and then select Clear Note.

Reviewing notes



The note title and the date you created the note appear in the Note Pad list. If you did not assign a title to your note, the time you created the note appears as the note title. This makes it easy to locate and review your notes.

To review a note:

1. In the Note Pad list, select the note title.

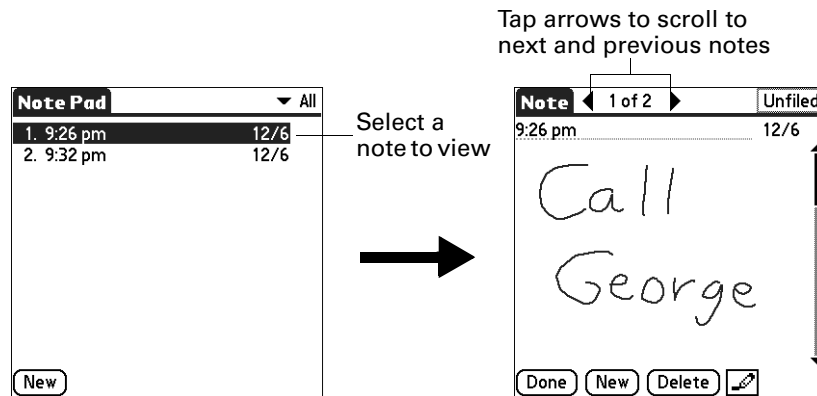
TIP You can also select, review, and move between notes with the navigator. See [“Using the navigator”](#) in [Chapter 3](#) for details.





2. Review or edit the contents of the note.
3. Press Function  + Enter , or tap Done.

Changing Note Pad color settings

By default, your notes appear with a white “paper” background, and the ink from the pen is blue. You can change the color of both the paper and the ink from the pen. Your color selections apply to all your notes. You cannot change the color settings for individual notes.



To set the colors:

1. In the Note Pad list, press Command Stroke  + R.

Alternately, press Function  + Menu , and then select Preferences on the Options menu.

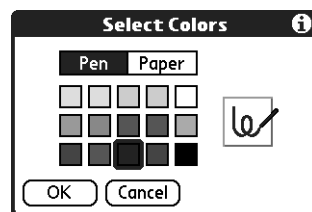
2. Tap Color.



3. Tap Pen, and then tap the color of ink you want to use.
4. Tap Paper, and then tap the color of paper you want to use.
5. Press Function  + Enter , or tap OK.

Setting an alarm for a note

You can set an alarm for a specific time and date to remind you to follow up on a note.

To set an alarm for a note:

1. Tap the note to which you want to assign an alarm.
2. Press Command Stroke  + A.



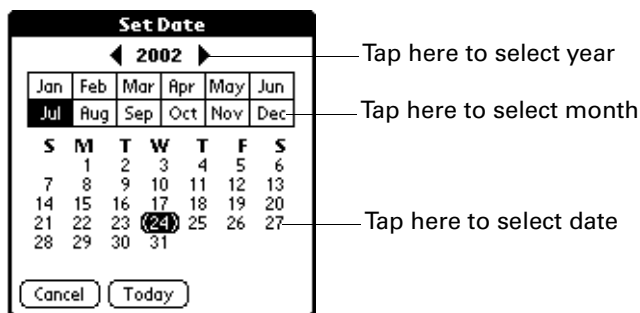

Alternately, press Function  + Menu , and then select Alarm on the Options menu.

3. Tap the Date box.

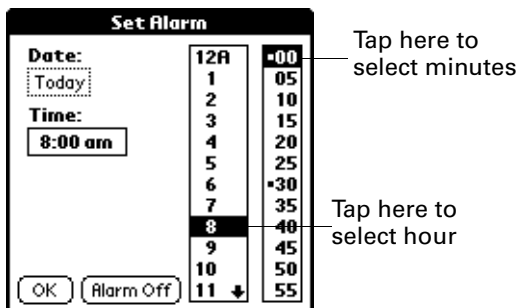

4. Tap the year, month, and date you want the alarm to sound.
After you tap the date, the Set Alarm dialog box reappears.
5. Tap the Time box.
6. Tap the hour and minute columns to select the time you want the alarm to occur.



7. Press Function  + Enter , or tap OK.
8. When the alarm goes off and the reminder message appears onscreen, do one of the following:
 - Press Function  + Enter , or tap OK to permanently dismiss the reminder and return to the current screen.
 - Tap Snooze to dismiss the reminder and return to the current screen. An attention indicator blinks in the upper-left corner of the screen to remind

you of the pending alarm, and the reminder message appears again in five minutes. When the reminder message reappears, the current time appears in the Reminder bar and the note title appears on the screen.

- If you did not title the note, the time the note was created appears on the screen.
- Tap Go To to open Note Pad. Note Pad will open and display the note associated with the alarm.

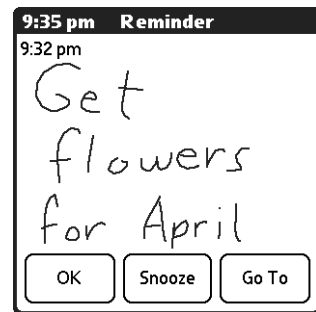

Using Note Pad menus

Note Pad menus are shown here for your reference, and Note Pad features that are not explained elsewhere in this book are described here.

The Record menu is the same when you're viewing the Note Pad list and an individual note. The Options menu differs depending on whether you're viewing the Note Pad list or an individual note.

Record menu

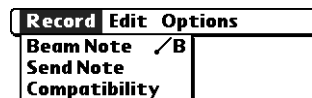

- | | |
|----------------------|---|
| Send Category | Opens a dialog box where you can choose how you want to send all records in the selected category to another device. The options available depend on the software installed on your handheld. |
| Send Note | Opens a dialog box where you can choose how you want to send the selected note to another device. The options available depend on the software installed on your handheld. |
| Compatibility | Displays the Compatibility dialog box, where you can choose to beam notes to a previous version of Note Pad. |

Options menus



Note Pad list



Note screen

- Preferences** Displays the Note Pad Preferences dialog box, where you define the pen and paper color, the sort order for notes, and the alarm sound.
- Details** Displays the Note Details dialog box, where you assign a category and privacy option for a note.
- About Note Pad** Shows version information for Note Pad.

Using SIM Manager



SIM Manager enables you to access the names and numbers residing on your SIM card and then transfer the information to your Address Book. In SIM Manager, you can do the following:

- View the names and numbers on your SIM card.
- Copy the information to your Address Book.
- Edit the record information.
- Copy Address Book information to SIM Manager.

IMPORTANT To access SIM Manager, you must first perform a HotSync® operation with your handheld. SIM Manager is automatically loaded onto your handheld during the first HotSync operation.

To open SIM Manger:

1. Press Home .
2. Tap the SIM Manager icon .

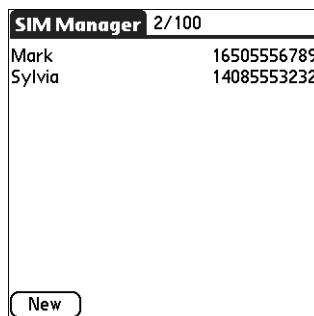

Adding SIM Manager items

A record in SIM Manager is called an *item*.

To add a SIM Manager item:

1. Tap New.

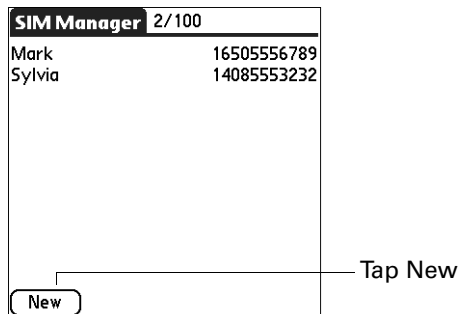

2. Enter the name and number.

You can use the Lookup function to access numbers from your Address Book.

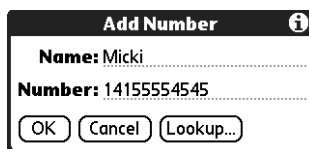

3. Press Function  + Enter  or tap OK.



Managing SIM Manager items

You can edit and delete items and copy items to the Address Book.

To edit or delete a SIM Manager item:

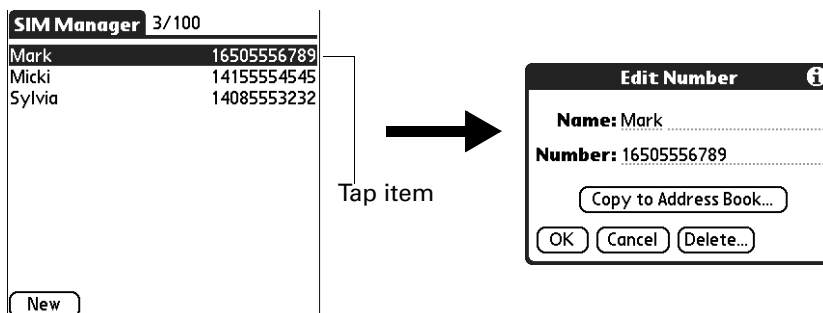
1. Tap an item.





2. Edit the information or delete the item.
3. Press Function  + Enter  or tap OK.

To copy a SIM Manager item to the Address Book:

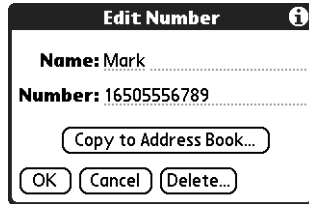
1. Tap an item.
2. Tap Copy to Address Book.



3. Do one of the following:
 - Press Function  + Enter  or tap OK to add the item to the Address Book and go back to the SIM Manager main screen.
 - Tap Copy & Go to open the Address Book where you can enter all the Address Book entry details.

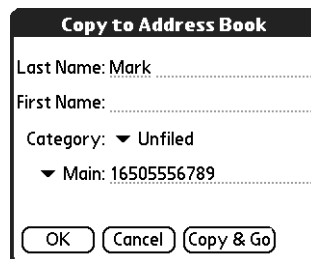

Using SIM Manager menus

SIM Manager menus are shown here for your reference, and SIM Manager features that are not explained elsewhere in this book are described here.

See “Using menus” in [Chapter 4](#) for information about choosing menu commands.

Record menu



Copy All to Address Book Copies all items to the Address Book.

Options menu



About SIM Manager Shows version information for SIM Manager.

Using SIM Services



SIM Services enables you to access applications stored on the SIM card. These applications are provided by your wireless service provider. The types of applications differ depending on your wireless service provider. The following are examples of the kinds of applications that can be provided:

- Access your bank account balance.
- Remind you of your number.
- Manage your network preferences, like prepaid account and Multi-SIM settings.
- Request information, such as local traffic information, weather forecast, current exchange rates, and stock values.
- Play games.
- Receive notification when a friend is in the vicinity.
- Manage your electronic purse and buy wirelessly.
- Find the nearest movie theater.

IMPORTANT Contact your wireless service provider for information on which services are available.

Accessing a service

You can access the services provided by your wireless service provider.

IMPORTANT Instructions on how to use a service is provided by your wireless service provider.

To access a service:

1. Press Home .
2. Tap the Services icon .



3. Tap a service and tap Launch.

Using the SIM Services menu

The SIM Services menu is shown here for your reference, and the SIM Services feature that are not explained elsewhere in this book are described here.

See “Using menus” in [Chapter 4](#) for information about choosing menu commands.

Options menu



About SIM Services

Shows version information for SIM Services.

Using SMS



The SMS application enables you to send and receive short text messages using your handheld. The messages are sent to a mobile phone, using the phone number as an address.

Most GSM mobile phone service providers have supported Short Message Service technology for quite a while, and billions of SMS messages are exchanged each month. Use SMS to do the following:

- Send messages to mobile phones.
- Review SMS messages.
- Use the keyboard on your handheld to quickly create SMS messages.
- Receive records associated with your other handheld applications. For example, your boss can send you a Date Book event for a meeting you need to attend. When you receive the message, you can choose to add it to your Date Book or view the raw data as a text message.

IMPORTANT Whenever you use the wireless features of your handheld, please observe the guidelines or prohibitions on the use of wireless devices in your current location. For example, when you are on an airplane, do not turn on your radio at times when government or airline regulations prohibit the use of cellular phones. You can, of course, use all other applications of your handheld in accordance with airline regulations for electronic devices.

To open SMS:

1. Press Home .
2. Tap the SMS icon .



Creating messages

When you create a message, the title bar indicates the number of characters the message contains. If a message exceeds 160 characters, it is split into multiple messages. When the recipient receives those messages, they may be reassembled into a single message (provided the recipient's SMS software supports assembling multi-part messages). Otherwise, they will appear as two messages.

To create a message:

1. From any SMS list view, tap New.

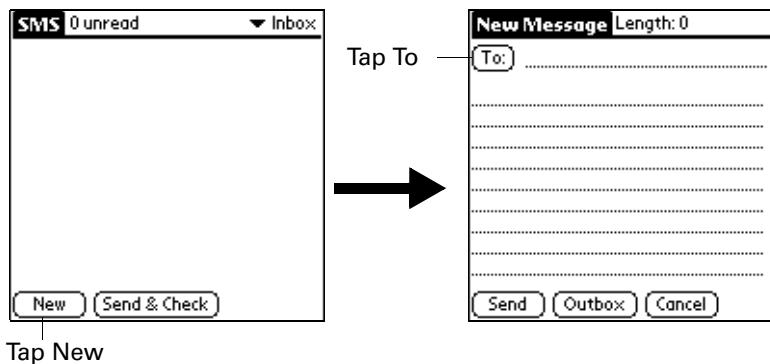

2. Tap To.

3. Tap the recipient's name, and then tap Add.

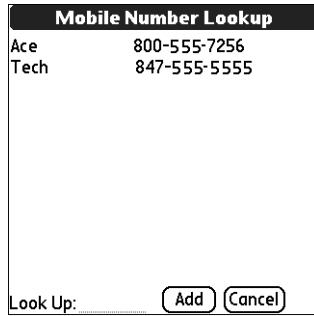

TIP To send a message to someone who isn't listed in your Address Book, enter their mobile phone number on the To line. The mobile phone number must be on a compatible SMS network—for example, a GSM network.

4. Enter the message text.
5. Tap Send or press Command Stroke (⌘) + E to send the message now, or tap Outbox to send the message later.

NOTE Tapping Send does not send any of the other messages in your Outbox. It sends only the current message.

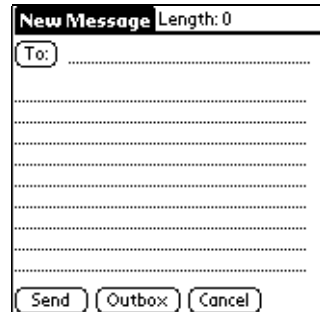

Tap Send  Tap Outbox 

Sending and receiving messages

You can send all the messages in your Outbox and retrieve all the new messages at the same time.

To send and receive messages at the same time:

- Do one of the following:
 - From any SMS list view, tap Send & Check.
 - If you have assigned one of the application buttons to open SMS, press and hold the SMS application button for two seconds. See “Buttons preferences” in [Chapter 21](#) for more information on assigning application buttons.

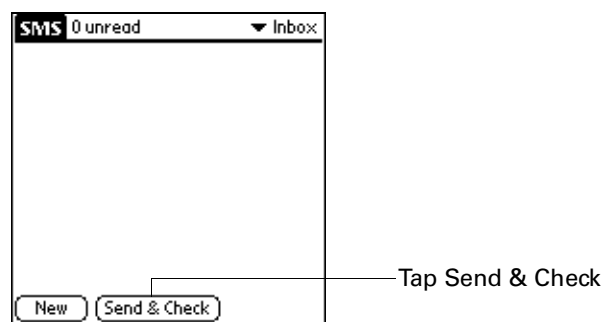

After the transmission finishes, a message appears, indicating the number of new messages you received.

To send all messages in your Outbox:

- Do one of the following:
 - From message view, press Command Stroke (⌘) + E.
 - From list view, press Command Stroke (⌘) + S.
 - From any view, press Function (fn) + Menu (⌘), and then select Send on the Message menu.

To download all messages:

- From the list view, do one of the following:
 - Press Command Stroke (⌘) + H.
 - From any view, press Function (fn) + Menu (⌘), and then select Check on the Message menu.

Viewing messages

SMS stores your messages in five separate categories:

Inbox	Stores downloaded messages.
Outbox	Stores messages waiting to be sent.
Trash	Stores messages you deleted. You can restore deleted messages to their original category.
Archive	Files messages you want to keep.
Draft	Stores messages you want to change or review before you send them.

In the Inbox and Outbox, icons appear next to the message to indicate whether it has been read or sent. In the Inbox, additional icons indicate whether the message is incomplete and whether it contains data other than text that requires another application to read it.

TIP If you have assigned one of the application buttons to open SMS, you can press the SMS application button to cycle through the categories. See [“Buttons preferences”](#) in [Chapter 21](#) for more information on assigning application buttons.

To view text messages in your Inbox:

1. Tap the category pick list in the upper-right corner.
2. Select Inbox.

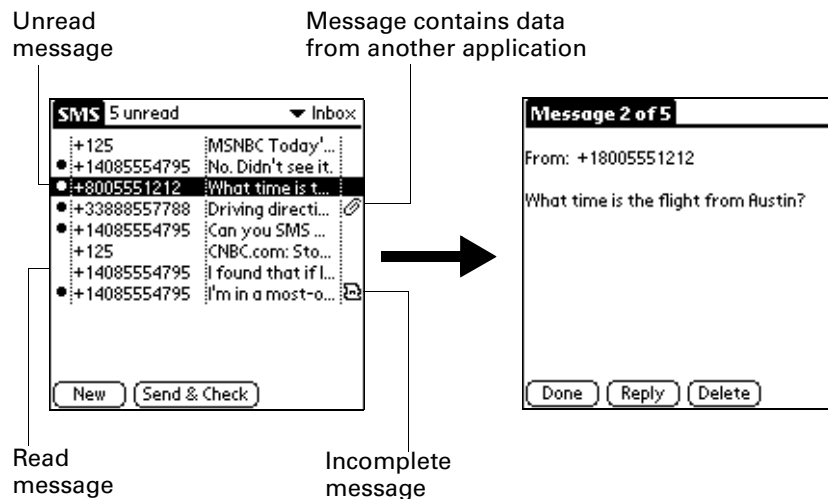

3. Tap the message you want to view.

4. Tap one of the following:

Done: Returns to the list view.

Reply: Creates a message to the sender and copies any selected text into the new message.

Delete: Moves the message to the Trash category.

To view data messages in your Inbox:

1. Tap the category pick list in the upper-right corner.
2. Select Inbox.
3. Tap the message you want to view.

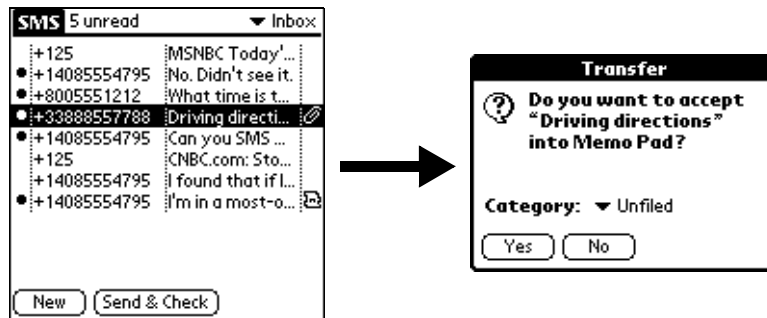

4. Do one of the following:

- Press Function + Enter ↵ , or tap Yes to add the data to the appropriate application.
- Press Function + Backspace ⌫ or tap No to view the raw data as a text message.

To view messages in your Outbox or Archive categories:

1. Tap the category pick list in the upper-right corner.
2. Select either Outbox or Archive.

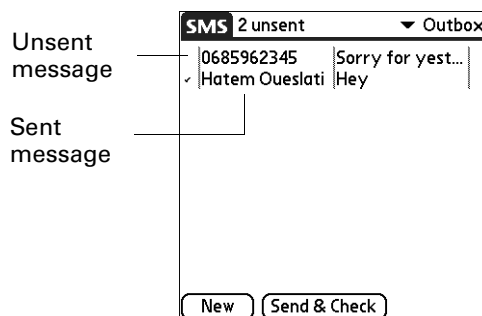

3. Tap the message you want to view.

4. Tap one of the following:

Done: Returns to the list view.

Edit: Opens the message so you can modify the contents.

Delete: Moves the message to the Trash category.

To view messages in your Trash:

1. Tap the category pick list in the upper-right corner.
2. Select Trash.
3. Tap the message you want to view.



4. Tap one of the following:

Done: Returns to the list view.

Restore: Moves the message back to the category it was in when you deleted it.

Working with draft messages

When you create a message, you can save it as a draft message. SMS does not send draft messages when you transmit the messages in your Outbox. You can store draft messages for as long as you like and review and edit them before you send them.

To place a message in the Draft category:

1. Create or open the message you want to store in the Draft category.
2. From the Message view, press Command Stroke (⌘) + D.

Alternately, press Function (fn) + Menu (⌘), and then select Draft on the Message menu.

To view or edit draft messages:

1. Tap the category pick list in the upper-right corner.
2. Select Draft.
3. Tap the message you want to edit.

- In the message view, tap Edit.

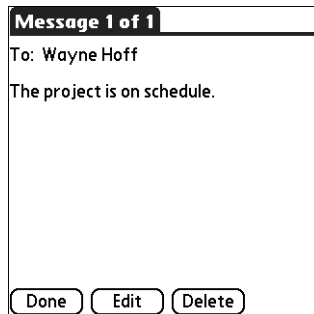

- Edit the message.
- Tap one of the following:
 - Send:** Sends the message now.
 - Outbox:** Moves the message to the Outbox to be sent later.
- Cancel:** Opens a dialog box that asks if you want to save the message in the Draft category. Press Function + Enter , or tap Yes to keep your changes and return the message to the Draft category. Press Function + Backspace or tap No to delete the message.

Adding a signature to a message

A signature is standard text that appears at the end of a message. You can define your own personal signature and then add it to a message by using menu commands.

To define a signature:

- Press Command Stroke + R.

Alternately, press Function + Menu , and then select Preferences on the Options menu.

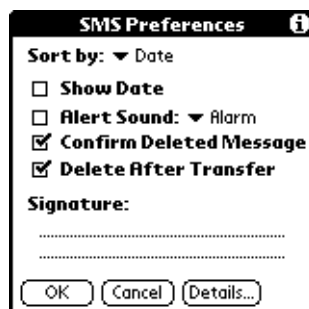

- Enter your signature.
- Press Function + Enter , or tap OK.

To add your signature to a message:

1. Create or edit the message where you want to add your signature.
2. From the message view, press Command Stroke (✍️) + Z.

Alternately, press Function (Ⓜ) + Menu (✍️), and then select Add signature on the Options menu.

Sending data from another application

In addition to creating text messages, you can create a message that contains data from an application on your handheld. For example, you can send a Date Book event to someone to remind them to add a meeting to their calendar. If the recipient receives the message on a handheld, they can transfer the message directly to the appropriate application. If the recipient receives the message on another device, the data appears as text.

To send data from another application:

1. Open the record you want to send.
2. Press Function (Ⓜ) + Menu (✍️).
3. Tap Record, and then tap Send Event, Send Address, Send Item, Send Note, or Send Memo (based on the application).

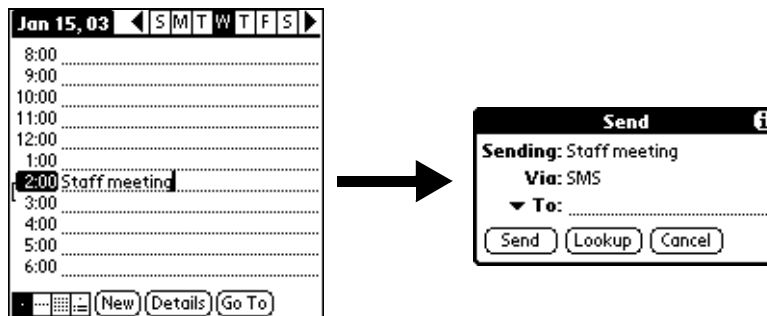

4. Tap the To pick list to select from a list of recent recipients, or tap Lookup to select a number from your Address Book.
5. Tap Send.

Setting preferences

The SMS Preferences screen enables you to customize several of the settings in the SMS application.

To view or change SMS Preferences:

1. Press Command Stroke (✓) + R.

Alternately, press Function (○) + Menu (✓), and then select Preferences on the Options menu.



2. Change any of the following options:

- | | |
|--------------------------------|--|
| Sort by | Determines how messages in the list views are sorted. Tap the pick list to select from the following options: Alphabetic, Date, Phone Number, and Status. |
| Show Date | Indicates whether dates appear in the list view. To display dates, select this check box. |
| Alert Sound | Indicates whether a new messages triggers an alert and which alert it triggers. To trigger a new message alert, select this check box. Tap the pick list to select one of the following sounds: Alarm, Alert, Bird, Concerto, Phone, Sci-fi, or Wake up. |
| Confirm Deleted Message | Indicates whether a confirmation message appears each time you delete a message. To display confirmation messages, select this check box. |
| Delete After Transfer | Indicates whether data messages are deleted after you accept the data in the appropriate application. To keep data messages after you transfer them to the application, deselect this check box. |
| Signature | Enables you to enter a personal signature that you can add to your messages. |



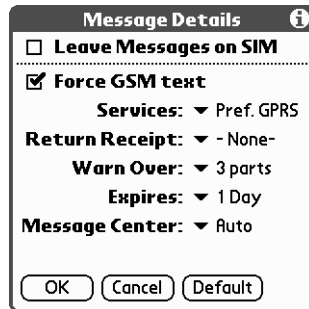

3. Tap Details.



4. Change any of the following options:

- Leave Messages on SIM** Determines whether the current messages remain on the SIM card after they are downloaded to the SMS application. This option affects only the messages currently residing on the SIM card and not newly received messages.
- Force GSM text** Determines whether to send 7-bit data or 8-bit data. Seven-bit data is the most compatible with phones. When the check box is selected, only 7-bit data is sent.
- Services** Tap the pick list to select from the following options: Force GPRS, Force GSM, Pref. GPRS, Pref. GSM. When a service is forced, only that service is used. When a service is preferred, that service is used first and, if necessary, is switched to the other service.
- Return Receipt** Determines whether you receive receipt confirmation notices. Tap the pick list to select from the following options: None and Requested.
- Warn Over** Determines whether you receive a warning when multi-part messages exceed more than the specified number of parts. Tap the pick list to select from the following options: 1 part, 3 parts, 5 parts, 10 parts, 50 parts, and Never warn.
- Expires** Indicates how long the server keeps attempting delivery of a message. Tap the pick list to select from the following options: 4 Hours, 1 Day, 1 Week, 2 Weeks, 1 Month, and Max. Time.
- Message Center** Indicates whether your handheld obtains your mobile phone service provider's Message Center number directly from the SIM card, or whether you need to enter the number manually. Tap the pick list to select either Auto or Custom.

TIP To restore all of these options to the original settings, tap Default.

5. Press Function  + Enter , or tap OK to close the Message Details dialog box.
6. Press Function  + Enter , or tap OK.

Using SMS menus

SMS menus are shown here for your reference, and application features that are not explained elsewhere are described here. For information about Edit commands, see [Chapter 4](#).

See “Using menus” in [Chapter 4](#) for information about choosing menu commands.

Message menu

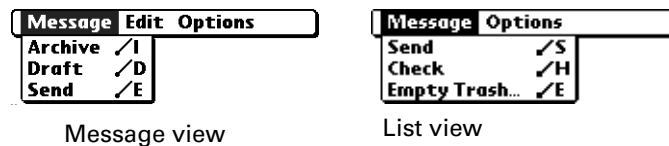

- Archive** Moves the current message to the Archive category.
- Draft** Moves the current message to the Draft category.
- Send** Sends all messages in the Outbox.
- Check** Retrieves all messages.
- Empty Trash** Prompts you to confirm that you want to permanently remove all messages in the Trash category from your handheld.

Options menu

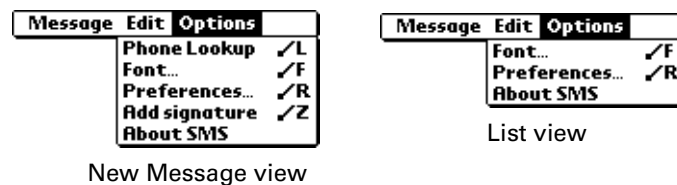

- Phone Lookup** Opens the Phone Lookup dialog box, where you can select a mobile phone number where you want to send a message.
- Font** Opens the Font dialog box, where you can choose various fonts for the list and message views.
- About SMS** Shows version information for the SMS application.

Using To Do List

 To Do List is a convenient place to create reminders and prioritize the things that you have to do. Use To Do List for the following:

- Make a quick and convenient list of things to do.
- Assign a priority level to each task.
- Assign a due date for any or all of your To Do List items.
- Assign To Do List items to categories so that you can organize and view them in logical groups.
- Sort your To Do List items by due date, priority level, or category.
- Attach notes to individual To Do List items for a description or clarification of the task.

To open To Do List:

1. Press Home .
2. Tap the To Do icon .

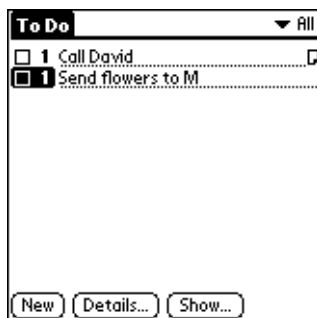

Creating list items

A To Do List item is a reminder of some task that you have to complete. A record in To Do List is called an *item*.

To create a To Do List item:

1. Do one of the following:
 - Tap New.
 - If no To Do List item is currently selected, begin typing.

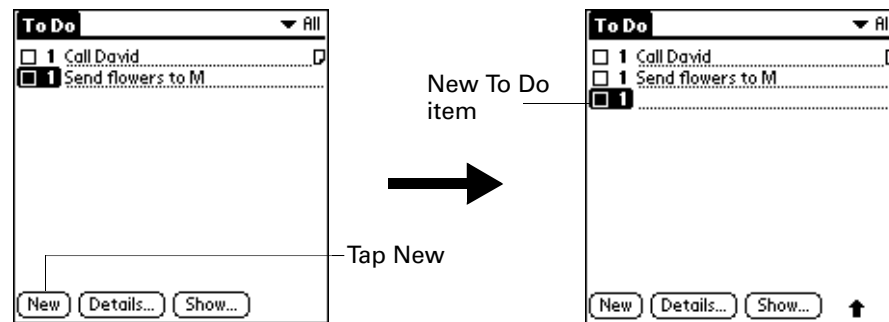

2. Enter the text of the To Do List item. The text can be longer than one line.
3. Tap anywhere onscreen to deselect the To Do List item.

Setting priority

You can use priority setting for items to arrange the tasks in your To Do List according to their importance or urgency. The default setting for the To Do List is to arrange items by priority and due date, with priority 1 items at the top. If you have a number of items in your list, changing an item's priority setting may move its position in the list.

When you create a new To Do List item, its priority is automatically set to level 1, the highest (most important) level. If you select another item first, however, the item you create appears beneath the selected item and is given the same priority as the selected item.

To set the priority of a To Do List item:

1. Tap the Priority number on the left side of the To Do List item.

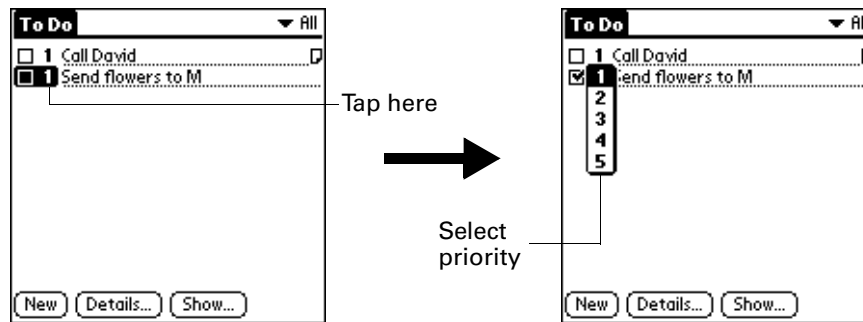

2. Select the Priority number that you want to set (1 is most important).

Checking off a To Do List item

You can check off a To Do List item to indicate that you've completed it. You can set the To Do List to record the date that you complete the To Do item, and you can choose to show or hide completed items. See ["Setting To Do Preferences"](#) later in this chapter.

To check off a To Do List item:

- Tap the check box on the left side of the item.

TIP You can also highlight the item you want to check off, and then press Select on the navigator.

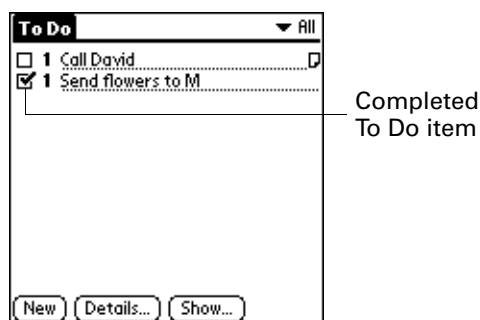

Changing To Do List item details

The To Do Item Details dialog box enables you to change settings for individual items.

To display the To Do Item Details dialog box:

1. Tap the text of the item whose details you want to change.

TIP You can also select an item with the navigator.

2. Tap Details.



Setting a due date

You can associate a due date with any To Do List item. You can also sort the items that appear in the list based on their due dates.

To set a due date for a To Do List item:

1. In the Details dialog box, tap No Date to open the Due Date pick list.

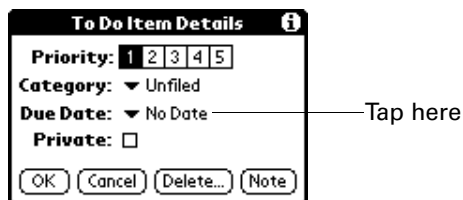

2. Tap the date that you want to assign the item:

Today	Assigns the current date.
Tomorrow	Assigns tomorrow's date.
One week later	Assigns the date exactly one week from the current date.
No Date	Removes the due date from the item.
Choose date	Opens the date selector, where you can choose any date that you want for the item.

3. Tap OK.

TIP If you turn on the Show Due Dates option in the To Do Show options dialog box, you can tap directly on the due date in the To Do List to open the pick list shown in step 2.

Setting To Do Preferences

The To Do Preferences dialog box enables you to control the appearance of To Do List and of To Do items in the Date Book Agenda view.

To change the Preferences settings:

1. In To Do List, tap Show.



2. Select any of the following settings:

Show Completed Items Displays your completed items in the To Do List. If you turn off this setting, your To Do items disappear from the list when you complete (check) them.

Items that no longer appear on the list because you turn off this setting have not been deleted. They are still in the memory of your handheld. Purge completed items to remove them from memory.

Show Only Due Items Shows only the items that are currently due, are past due, or have no due date specified. When this setting is active, items that are not yet due do not appear in the list until their due dates.

Record Completion Date Replaces the due date with the actual date when you complete (check) the item. If you do not assign a due date to an item, the completion date still records when you complete the item.

Show Due Dates Displays the due dates associated with items in the To Do List and displays an exclamation mark next to items that remain incomplete after the due date passes.

Show Priorities Shows the priority setting for each item.

Show Categories Shows the category for each item.

3. Tap OK.

Using To Do List menus

To Do List menus are shown here for your reference, and To Do List features that are not explained elsewhere in this book are described here.

See “Using menus” in [Chapter 4](#) for information about choosing menu commands.

Record menu

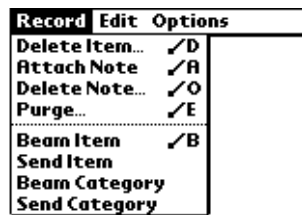

Send Item Opens a dialog box where you can choose how you want to send the selected item to another device. The options available depend on the software installed on your handheld.

Send Category Opens a dialog box where you can choose how you want to send all records in the selected category to another device. The options available depend on the software installed on your handheld.

Options menu



About To Do List Shows version information for To Do List.

Using Palm™ VersaMail™ Personal E-mail Software

IMPORTANT Depending on where you purchased your Palm™ Tungsten™ W handheld, you may have Palm™ VersaMail™ personal e-mail software installed on your handheld, or you may have a third-party e-mail application installed. If you have the VersaMail application installed on your handheld, read this chapter. If you have a third-party e-mail application installed, refer to the e-mail application documentation that came with your handheld for information.

With the VersaMail application, you can send, receive, and manage e-mail on your handheld. This chapter describes how to set up different types of e-mail accounts and explains how to use the many e-mail features in the VersaMail application.

The VersaMail application is the newest offering in the line of Palm personal e-mail software applications. Formerly known as MultiMail® software, the VersaMail application contains new features that make sending and receiving e-mail messages and managing e-mail accounts easier than ever.

Key features of the VersaMail 2.0 application include the following:

- Support for both the Tungsten W navigator and keyboard, simplifying data entry and navigation
- Support for both the built-in GSM (dial-up) and GPRS (high-speed) radio in your handheld, enabling wireless e-mail connectivity

NOTE If you want to use the built-in GPRS or GSM radio in your handheld to make a network connection, you must set up service with a GPRS or GSM provider.

Getting started with the VersaMail application

The VersaMail application is built into your handheld and does not need to be installed. To start using the application, press the VersaMail button  on your handheld. The following sections describe some optional procedures before you begin using the VersaMail application.

Synchronizing an existing username

If you plan to synchronize your Tungsten W handheld with an existing username by performing a HotSync® operation, you must do so before you enter your e-mail account information in the VersaMail application. If you enter the e-mail account information first and then synchronize your handheld to an existing username, the username information overwrites the e-mail account information you entered.

Upgrading a MultiMail database

If you have previously used a Palm personal e-mail application such as MultiMail SE or MultiMail Deluxe, you can upgrade your e-mail database for use with the VersaMail application.

To upgrade an existing e-mail database for use with the VersaMail application:

1. Perform a HotSync operation with a user profile that contains the existing e-mail database. To do so, press the HotSync button ™, and then select a profile that contains an e-mail database from the displayed list of users.

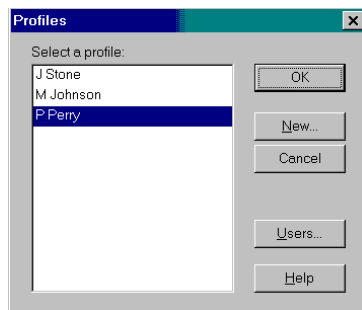

2. Press the VersaMail button  on your handheld.
3. Tap Yes to accept the upgrade.

Installing Documents To Go

Documents To Go enables you to convert attachments using HotSync operations. With Documents To Go, you can view Word, Excel, and PowerPoint attachments on your handheld. DataViz Documents To Go attachment conversion plug-ins are automatically configured to work with the VersaMail application.

Version 5 of Documents To Go is included on the Software Essentials CD-ROM that came with your Tungsten W handheld. See the *Documents To Go Getting Started Manual* for more information.

Setting up and managing e-mail accounts

With the VersaMail application, you can access e-mail accounts from providers such as Earthlink or Yahoo. Some companies may also allow access to corporate e-mail with the appropriate mail server configuration. See “[Accessing corporate e-mail](#)” later in this chapter for more information.

You can add up to eight e-mail accounts on your handheld by setting up a connection to a network provider or synchronizing to a desktop e-mail application. For example, if you have a Yahoo e-mail account with POP access, you can create a new account in the VersaMail application and name that new account Yahoo, so that you can send and receive e-mail on your handheld using your Yahoo account.

Account and connection types

Two types of e-mail accounts are supported:

- **Network:** You can send and receive e-mail directly to and from your handheld by connecting with a network provider.
- **Synchronize Only:** You can download, view, and manage e-mail between the handheld and a desktop e-mail application, such as Microsoft Outlook, by performing a HotSync operation using the cradle/cable. You can't send and receive messages wirelessly or with a modem for an account of this type.

Using a network account, you can set up or access an e-mail account using any of the following connection methods:

- Built-in GPRS (high-speed) and GSM (dial-up) radio on your handheld
- Palm™ Bluetooth Card (sold separately) attached through the expansion card slot connecting to a mobile phone or local access point that is enabled with Bluetooth technology
- PalmModem® accessory (sold separately)
- External modem sled (for example, 802.11 sled)
- Infrared (IR) port on the handheld to infrared port on a mobile phone
- Direct connection to a mobile phone by means of a physical cable
- Handheld cradle connected to your desktop (Windows users only)

Setting up the default account that came with your handheld

Depending on where you purchased your handheld, you may have a default e-mail account preconfigured by a carrier. This is either a high-speed GPRS account or a dial-up GSM account. If your wireless carrier preconfigured your e-mail account, you need to enter username and password information before you can use the account.

To determine if you have a preconfigured e-mail account on your handheld:

- The first time you use the VersaMail application, press the VersaMail button . If a screen prompting you to enter your username and password appears immediately, you have a preconfigured carrier e-mail account. If any other account setup screen appears, you do not have a preconfigured carrier e-mail account.

TIP Check with your wireless carrier to determine whether your handheld comes with a preconfigured e-mail account.

To set up the default account that came with your handheld:

1. Press the VersaMail button .
2. Enter a username, and then tap the Password field. The username is supplied by your wireless carrier.

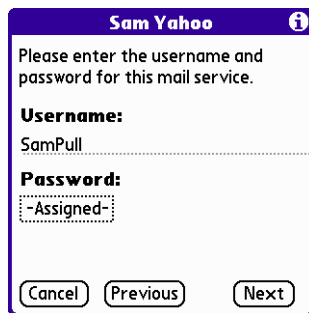

3. Enter a password when prompted, then tap OK. The password is supplied by your wireless carrier.
4. Tap Next, and then tap Next again.
5. Tap Done.

You are now ready to use your default e-mail account.

Setting up a new e-mail account

If your handheld did not come with a preconfigured carrier e-mail account, or if you want to set up a different account, you must set up a new e-mail account.

Setting up a network e-mail account

Before you can set up a network e-mail account, you must do the following:

- Establish the e-mail account with a network provider. Common network providers include Internet service providers (ISPs) such as Earthlink and Prodigy. A provider can also be a wireless GSM or GPRS carrier such as VoiceStream, Cingular, or VodaFone.
- Configure the service connection settings for this account on your handheld using your handheld's Network Preferences and Connection Preferences screens. See [Chapter 21](#) for more information.

You must also have the appropriate prerequisite for the type of connection you want to make, as follows.

Connection Type	Prerequisite
High-speed GPRS	Active GPRS service ordered from your wireless carrier.
GSM dial-up	Active wireless service with a GSM carrier. If you are using GPRS, the same carrier generally provides both GSM and GPRS service. Note that some GSM carriers require you to order a special data service (separate from voice service) to make a network connection.
Palm Bluetooth Card attached through SD slot	Palm Bluetooth Card and mobile phone or LAN access point enabled with Bluetooth technology.
PalmModem accessory	PalmModem accessory.
External modem sled (for example, 802.11)	Wireless modem accessory.
IR to IR phone	IR-enabled mobile phone.
Direct connection to a phone by means of a physical cable	Connector cable and mobile phone.
Handheld cradle connected to desktop	Handheld cradle and cable (Windows users only).

Using a GPRS/GSM carrier

If you want to use the built-in GPRS or GSM radio on your handheld to make a network connection, you must have (or you must set up) service with a GPRS or GSM provider. Many providers give you an e-mail account with your monthly data service subscription.

Using an ISP

In addition to or instead of using a carrier-provided e-mail account (for example, an e-mail account from VoiceStream), you may want to access other e-mail accounts (for example, a Yahoo or Earthlink e-mail account) that send and receive messages using your GPRS or GSM connection.

If you are setting up a new e-mail account and have a well-known ISP such as Earthlink or Mindspring, many of the required settings during the account setup are automatically configured.

For other ISPs, you need the following information:

- The protocol used for incoming mail, such as POP or IMAP
- The name of the incoming mail server
- The name of the outgoing mail (SMTP) server
- Whether your e-mail account requires any encryption, such as APOP or ESMTP
- Your e-mail address and password
- The login script (if any) that you need for connecting to your ISP or mail server

NOTE Information about your e-mail account is available from the e-mail provider. Depending on the type of e-mail service you have, you may be able to access this information by going to the e-mail provider's web site or by contacting the provider's customer support.

Creating a network e-mail account

You create a new account in Account Setup, which guides you through the process.

To create a network e-mail account:

1. Press Function  + Menu , select Accounts, and select Account Setup.

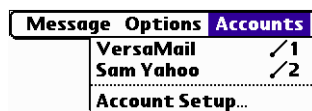

2. Tap New.

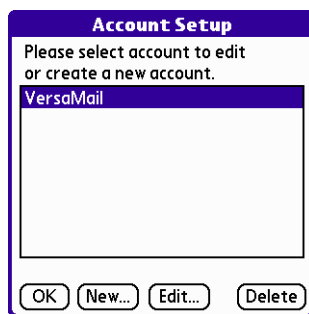

3. Enter the following:
 - **Account Name:** Enter a descriptive name for the account, such as “My Yahoo.”
 - **Mail Service:** Tap the Mail Service pick list and select the provider to which you are connecting. Select Other if your ISP is not listed.
 - **Protocol:** Tap the Protocol pick list and select POP or IMAP. (Most e-mail providers use the POP protocol.)

If the VersaMail application knows the protocol for the mail service you selected, it displays the correct protocol.



4. Tap Next.

Entering the account username and password

In the next part of the VersaMail Account Setup, you enter the username and password for this account.

To enter the account username and password:

1. Enter the username you use to access your e-mail. This is generally the part of your e-mail address appearing before the @ symbol; it is usually not your entire e-mail address.

2. Tap the Password box, and then enter your password. The Password box displays the word “Assigned” to indicate that a password has been entered.
3. Press Function  +Enter , or tap OK.
4. Tap Next.

Entering the name of the outgoing and incoming mail server

You need to verify your e-mail address for the account you are accessing, as well as enter the name of the outgoing and incoming mail servers.

To enter mail server settings:

1. If you chose a preconfigured service from the Mail Services pick list on the Account Setup screen, the e-mail address field is completed automatically based on the username and mail service you entered. Check the address to verify that it is correct, and edit it if necessary.

If you chose Other from the Mail Services pick list on the Account Setup screen, enter the e-mail address for your account.

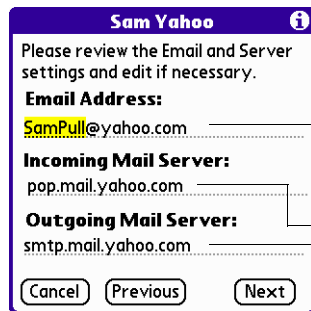

E-mail address will be filled in automatically if you chose a preconfigured mail service

Mail servers will be filled in automatically if the VersaMail application knows the names based on the mail service you chose

2. Enter the name of your incoming (POP) mail server, such as pop.mail.yahoo.com.

If the VersaMail application knows the incoming mail server name based on the mail service you selected, the correct server name is displayed.

3. Enter the name of your outgoing (SMTP) mail server, such as smtp.mail.yahoo.com.

If the VersaMail application knows the outgoing mail server name based on the mail service you selected, the correct server name is displayed.

4. Tap Next.

5. Do one of the following:
 - To accept these mail options and begin using the VersaMail application, tap Done. This takes you to the Inbox of the account you set up. See [“Getting, sending, and managing e-mail”](#) later in this chapter to get and send e-mail.
 - To set up additional mail options, tap Next. Continue with the next set of procedures.



Setting mail retrieval options for a POP or IMAP account

The next VersaMail Setup screen displays different options depending on whether your mail service uses a POP or IMAP protocol.

To set mail retrieval server options for a POP or IMAP account:

1. (Optional) Select any of the following:
 - Select Get unread mail ONLY to download only unread mail to your handheld. If you don't choose this option and you tap Get & Send, all of your e-mail messages on your provider's mail server are downloaded to your Inbox, including messages you have already read. To get all mail (including mail you have already read) and not just unread mail, deselect Get unread mail ONLY.
 - To delete messages on your provider's mail server when they are deleted in the VersaMail application, select the Delete messages on the server when they are deleted in VersaMail check box.
 - (POP account only) To get e-mail on your handheld but also leave it on the server so you can view it later on your desktop, select the Leave mail on server check box. For example, if you create an account to receive e-mail from your Yahoo account and select this option, your old Yahoo e-mail is still visible the next time you visit Yahoo.com to access your Yahoo e-mail Inbox.
 - To limit the maximum size of an incoming e-mail message, enter the size in kilobytes (KB) for Maximum Message Size. The maximum size of an incoming message is 5KB by default, but you can enter a smaller size. The maximum size of an incoming message is 5KB by default, but you can enter

a smaller size. The maximum message size that you can retrieve is 60KB for the body text and 2MB total, including attachments.

POP accounts

Sam Yahoo ⓘ

Incoming Mail Options:

Get unread mail ONLY.

Delete messages on the server when they are deleted in VersaMail.

Leave mail on server (e.g., to view on desktop later).

Maximum Message Size: 256 Kb.

Cancel Previous Next

IMAP accounts

Sam IMAP ⓘ

Incoming Mail Options:

Get unread mail ONLY.

Delete messages on the server when they are deleted in VersaMail.

Maximum Message Size: 256 Kb.

Cancel Previous Next

2. Tap Next.

Setting outgoing mail options

Outgoing mail options are the same for POP and IMAP accounts.

To set outgoing mail options:

1. (Optional) Do any of the following:
 - **Display Name:** Enter the name you want to appear on your outgoing messages, such as “Joe Smith.”
 - **Reply To Address:** Enter the e-mail address that you want recipients to see and reply to on your e-mail messages, only if this is different from the e-mail address from which you are sending the message. For example, if you are sending a message from me@yahoo.com but you want recipients to reply to me@earthlink.net, enter the reply-to address here. Reply To Address makes it look as though the e-mail came from the address you entered.
 - **BCC:** Select the BCC check box to send a blind copy of any e-mail message you send to another e-mail address. The blind copy e-mail address is not seen by the other recipients of the message. For example, if you want a copy of all messages you send from your handheld to be sent to your corporate e-mail account, enter that e-mail address.

Sam Yahoo ⓘ

Outgoing Mail Options:

Your Name (for display only)
Sam Pul

Reply To Address: (if different than current account)

BCC a copy of outgoing msgs to:

Cancel Previous Next

2. Tap Next.

Adding a signature



If you want, you can add a signature to each e-mail message you send. For example, you can enter your name and telephone number so that it appears on each message you send.

To add a personal signature:

1. Tap the Attach Signature to messages check box, and then enter the text of the signature.

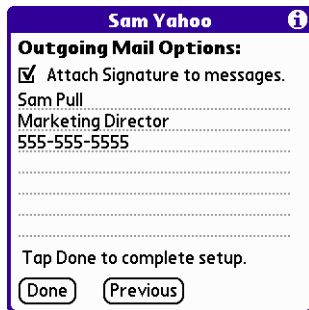
This signature is attached to all your outgoing e-mail.



2. Press Function  + Enter , or tap Done.



Testing your new account

After you finish setting up a new e-mail account, the Account Setup screen is displayed. Select the name of the account you just created and tap OK to go to the account's Inbox. You can test whether the e-mail account is set up and working properly by tapping Get Mail. See [“Getting e-mail by subject or getting the entire message”](#) later in this chapter for more information.

Creating a synchronize-only account

A synchronize-only e-mail account enables you to download, view, and manage e-mail between the handheld and a desktop e-mail application, such as Microsoft Outlook, by performing a HotSync operation by means of the cradle/cable. You can't send and receive messages wirelessly or with a modem for any account of this type.

To create a synchronize-only e-mail account:

1. Press Function  + Menu , select Accounts, and then select Account Setup.
2. Tap New.

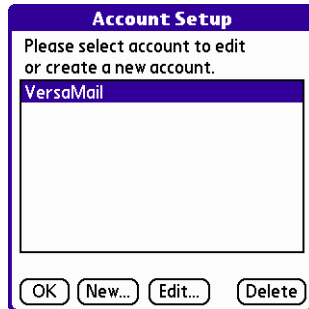

3. Do the following:
 - **Account Name:** Enter a descriptive name for this account, such as “My Yahoo.”
 - **Mail Service:** Tap the Mail Service pick list and select the provider to which you are connecting. Select Other if your ISP is not listed.
 - **Protocol:** Tap the Protocol pick list and select POP or IMAP. (Most mail providers use the POP protocol.)

If the VersaMail application knows the protocol for the mail service you selected, it displays the correct protocol.

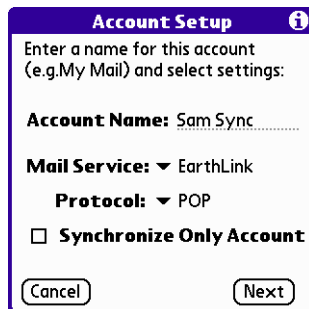

4. On the same screen, select the Synchronize Only Account check box.

Account Setup ⓘ

Enter a name for this account (e.g. My Mail) and select settings:

Account Name: Sam Sync

Mail Service: ▼ EarthLink

Protocol: ▼ POP

This is a sync-only account

Cancel Next

Select check box for a synchronize-only account

5. Tap Next.

Entering the account username and password

In the next part of the VersaMail Account Setup, you enter the username and password for this account.

To enter the account username and password:

1. Enter the username you use to access your e-mail. This is generally the part of your e-mail address appearing before the @ symbol; it is usually not your entire e-mail address.



Sam Sync ⓘ

Please enter the username and password for this mail service.

Username:
SamSync

Password:
-Assigned-

Cancel Previous Next

2. Tap the Password box, and then enter your password. The Password box displays the word “Assigned” to indicate that a password has been entered.
3. Press Function  + Enter , or tap OK.
4. Tap Next.

Entering the name of the outgoing and incoming mail server

You need to enter your e-mail address for the account you are accessing as well as the name of the outgoing and incoming mail servers.

To enter mail server settings:

1. Enter the e-mail address of the account you are accessing, such as “example@yahoo.com.”

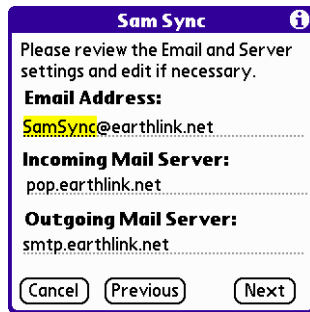

2. Enter the name of your incoming (POP) mail server, such as pop.mail.yahoo.com.

If the VersaMail application knows the incoming mail server name based on the mail service you selected, the correct server name is displayed.

3. Enter the name of your outgoing (SMTP) mail server, such as smtp.mail.yahoo.com.

If the VersaMail application knows the outgoing mail server name based on the mail service you selected, the correct server name is displayed.

4. Tap Next.
5. Do one of the following:
 - To accept these mail options and begin using the VersaMail application, tap Done. This takes you to the Inbox of the account you set up. See [“Getting, sending, and managing e-mail”](#) later in this chapter to get and send e-mail.
 - To set up additional mail options, tap Next. Continue with the next set of procedures.

Setting mail retrieval options for a POP or IMAP account

The next VersaMail Setup screen displays different options depending on whether your mail service uses a POP or IMAP protocol.

To set mail retrieval server options for a POP or IMAP account:

- (Optional) Select any of the following:
 - Select Get unread mail ONLY to download only unread mail to your handheld. If you don't choose this option and you tap Get & Send, all your e-mail messages on your provider's mail server are downloaded to your Inbox, including messages you have already read. To get all mail (including mail you have already read) and not just unread mail, deselect Get unread mail ONLY.
 - To delete messages on your provider's mail server when they are deleted in the VersaMail application, select the Delete messages on the server when they are deleted in VersaMail check box.
 - (POP account only) To get e-mail on your handheld but also leave it on the server so you can view it later on your desktop, select the Leave mail on server check box. For example, if you create an account to receive e-mail from your Yahoo account and select this option, your old Yahoo e-mail is still visible the next time you visit Yahoo.com to access your Yahoo e-mail Inbox.
 - To limit the maximum size of an incoming e-mail message, enter the size in kilobytes (KB) for Maximum Message Size. The maximum size of an incoming message is 5KB by default, but you can enter a smaller size. The maximum size of an incoming message is 5KB by default, but you can enter a smaller size. The maximum message size that you can retrieve is 60KB for the body text and 2MB total, including attachments.

POP accounts

IMAP accounts

- Tap Next.

Setting outgoing mail options

Outgoing mail options are the same for POP and IMAP accounts.

To set outgoing mail options:

1. (Optional) Enter or select any of the following:
 - **Display Name:** Enter the name you want to appear on your outgoing messages, such as “Joe Smith.”
 - **Reply To Address:** Enter the e-mail address that you want recipients to see and reply to on your e-mail messages, only if this is different from the e-mail address from which you are sending the message. For example, if you are sending a message from “me@yahoo.com” but you want recipients to reply to “me@earthlink.net,” enter the reply-to address here. Reply To Address makes it look as though the e-mail came from the address you entered.
 - **BCC:** Select the BCC check box to send a blind copy of any e-mail message you send to another e-mail address. The blind copy e-mail address is not seen by the other recipients of the message. For example, if you want a copy of all messages you send from your handheld to be sent to your corporate e-mail account, enter that e-mail address.

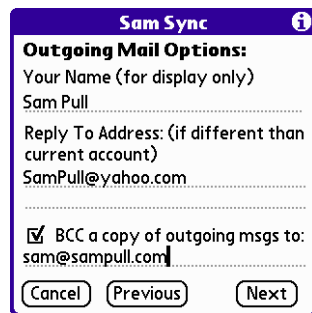

The screenshot shows a dialog box titled "Sam Sync" with an information icon in the top right corner. The dialog is titled "Outgoing Mail Options:" and contains the following fields and options:

- "Your Name (for display only)" with the text "Sam Pull" entered.
- "Reply To Address: (if different than current account)" with the text "SamPull@yahoo.com" entered.
- A checked checkbox labeled "BCC a copy of outgoing msgs to:" with the text "sam@sampull.com" entered below it.
- At the bottom, there are three buttons: "Cancel", "Previous", and "Next".

2. Tap Next.

Adding a signature



If you want, you can add a signature to each e-mail message you send. For example, you can enter your name and telephone number so that it appears on each message you send.

To add a personal signature:

1. Tap the Attach Signature to messages check box, and then enter the text of the signature.

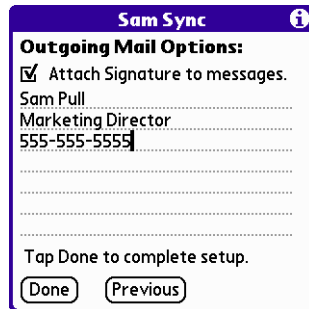
This signature is attached to all your outgoing e-mail.



2. Press Function  + Enter , or tap OK.



Configuring your synchronize-only account

After you finish setting up a synchronize-only e-mail account, you need to configure this account on your desktop. See [“Configuring an account in HotSync Manager”](#) later in this chapter for information. You will not be able to synchronize e-mail between your handheld and your desktop until you configure the account on your desktop.

Setting VersaMail connection preferences

You can set connection preferences for your e-mail accounts. These preferences apply to all accounts you have set up in the VersaMail application.

To set account connection preferences:

1. In your Inbox or another folder screen, press Function  + Menu .
2. Select Options.
3. Select Preferences.
4. Tap Advanced.

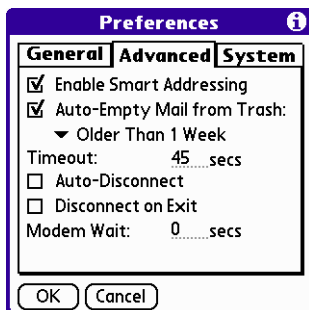

5. Select any of the following preferences:



- | | |
|-----------------------------------|--|
| Enable Smart Addressing | Types ahead and completes a recognized e-mail address. See the procedure for creating new e-mail later in this chapter for more information. |
| Auto-Empty Mail from Trash | Determines how often e-mail messages in the trash are automatically deleted. See “Emptying the trash” later in this chapter for more information. |
| Timeout | Sets the number of seconds to try to connect before timing out. If you are using an adapter with a mobile phone, this value should be greater than 45 seconds.

To change, tap the Timeout field and enter a new value. |
| Auto-Disconnect | Automatically disconnects your remote connections after each command. Each command you perform initiates a new call to your ISP. This setting is not recommended if you plan to perform multiple e-mail transactions in a short amount of time. |
| Disconnect on Exit | Disconnects from the network only after you leave the VersaMail application. This feature is an alternative to Auto-Disconnect. This option keeps your connection active while you perform multiple transactions in the VersaMail application, but automatically disconnects when you move on to a different application on your handheld. If this option is not selected, you must manually disconnect from your ISP. |
| Modem Wait | Displays the number of seconds that the modem uses to initialize itself. If you have a modem, tap and enter a number of seconds for the wait. The typical setting for a wireless modem is 3, and the typical setting for most normal modems is 0. |

Editing e-mail accounts

From time to time, you may need to edit information about one of the e-mail accounts you set up.

To select the account to edit:

1. Press Function  + Menu .
2. Select Accounts.
3. Select Account Setup.

4. Tap the name of the account to edit, and then tap Edit.

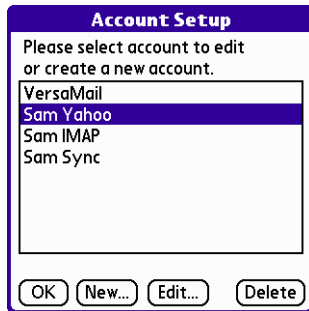

To edit an account:

1. On the Account Setup screen, change any of the following:
 - **Account Name:** Enter a descriptive name for this account, such as “My Yahoo.”
 - **Mail Service:** Tap the Mail Service pick list and select the provider to which you are connecting. Select Other if your ISP is not listed.
 - **Protocol:** Tap the Protocol pick list and select POP or IMAP. (Most mail providers use the POP protocol.)

If the VersaMail application knows the protocol for the mail service you selected, it displays the correct protocol.

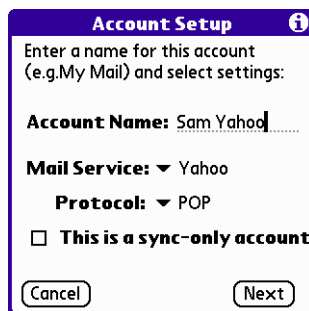



2. Tap Next.

Changing the account username and password

In the next part of the VersaMail Account Setup, you can change the username and/or password for this account.

To edit the account username and password:

1. (Optional) Enter a new username for accessing your e-mail. This is generally the part of your e-mail address appearing before the @ symbol; it is usually not your entire e-mail address.

2. (Optional) Tap the Password box, and then enter a new password. The Password box displays the word “Assigned” to indicate that a password has been entered.
3. Press Function  + Enter , or tap OK.
4. Tap Next.

Editing the name of the outgoing and incoming mail server

If your e-mail address or the name of the outgoing and incoming mail servers has changed or has been entered incorrectly, you can edit the address or server name.

To edit mail server settings:

1. (Optional) Enter a new e-mail address for the account you are accessing, such as “examplename@yahoo.com.”

2. (Optional) Enter the new or correct name of your incoming (POP) mail server, such as pop.mail.yahoo.com.

If the VersaMail application knows the incoming mail server name based on the mail service you selected, the correct server name is displayed.
3. (Optional) Enter the new or correct name of your outgoing (SMTP) mail server, such as smtp.mail.yahoo.com.

If the VersaMail application knows the outgoing mail server name based on the mail service you selected, the correct server name is displayed.

4. Tap Next.
5. Do one of the following:
 - To accept these mail options and begin using the VersaMail application, tap Done. This takes you to the Inbox of the account you set up. See “Getting, sending, and managing e-mail” later in this chapter to get and send e-mail.
 - To edit additional mail options, tap Next. Continue with the next set of procedures.



Editing mail retrieval options for a POP or IMAP account

The next VersaMail Setup screen displays different options depending on whether your mail service uses a POP or IMAP protocol.

To set mail retrieval server options for a POP or IMAP account:

1. (Optional) Select any of the following:
 - Select Get unread mail ONLY to download only unread mail to your handheld. If you don't choose this option and you tap Get & Send, all your e-mail messages on your provider's mail server are downloaded to your Inbox, including messages you have already read. To get all mail (including mail you have already read) and not just unread mail, deselect Get unread mail ONLY.
 - To delete messages on your provider's mail server when they are deleted in the VersaMail application, select the Delete messages on the server when they are deleted in VersaMail check box.
 - (POP account only) To get e-mail on your handheld but also leave it on the server so you can view it later on your desktop, select the Leave mail on server check box. For example, if you create an account to receive e-mail from your Yahoo account and select this option, your old Yahoo e-mail is still visible the next time you visit Yahoo.com to access your Yahoo e-mail Inbox.

- To limit the maximum size of an incoming e-mail message, enter the size in kilobytes (KB) for Maximum Message Size. The maximum size of an incoming message is 5KB by default, but you can enter a smaller size.

POP accounts

IMAP accounts

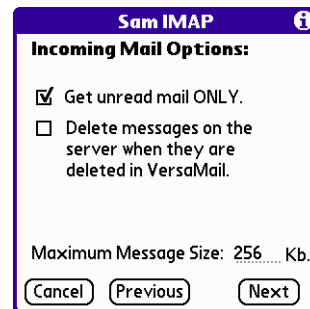
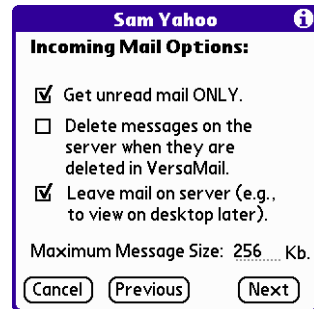

2. Tap Next.

Editing outgoing mail options

Outgoing mail options are the same for POP and IMAP accounts.

To set outgoing mail options:

1. (Optional) Do any of the following:
 - **Display Name:** Enter the name you want to appear on your outgoing messages, such as "Joe Smith."
 - **Reply To Address:** Enter the e-mail address that you want recipients to see and reply to on your e-mail messages, only if this is different from the e-mail address from which you are sending the message. For example, if you are sending a message from me@yahoo.com but you want recipients to reply to me@earthlink.net, enter the reply to address here. Reply To Address makes it look as though the e-mail came from the address you enter.
 - **BCC:** Select the BCC check box to send a blind copy of any e-mail message you send to another e-mail address. The blind copy e-mail address is not seen by the other recipients of the message. For example, if you want a copy of all messages you send from your handheld to be sent to your corporate e-mail account, enter that e-mail address.

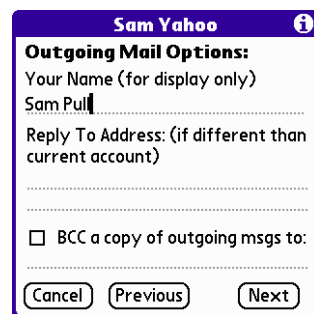

2. Tap Next.

Adding a signature



If you want, you can add a signature to each e-mail message you send. For example, you can enter your name and telephone number so that it appears on each message you send.

To add a personal signature:

1. Tap the Attach Signature to messages check box, and then enter the text of the signature.

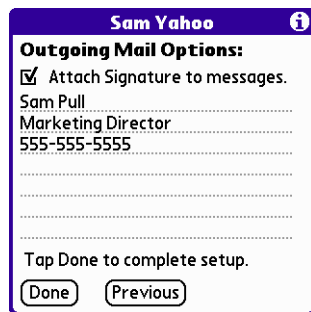
This signature is attached to all your outgoing e-mail.





2. Press Function  + Enter , or tap OK.

Deleting an e-mail account

When you delete an account in the VersaMail application, the account is removed from your handheld. The account still exists on the server. For example, deleting your Yahoo account from the VersaMail application deletes only the account from your handheld. Your e-mail account still exists at Yahoo.com.

To delete an account:

1. Press Function  + Menu .
2. Select Accounts.
3. Select Account Setup.



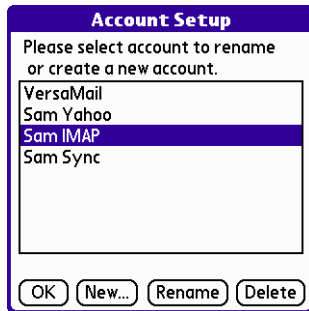

4. Tap the name of the account you want to delete, and then tap Delete.

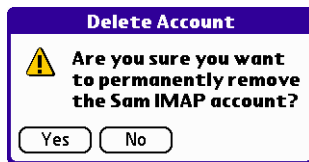

5. Tap Yes in the Delete Confirmation dialog box to delete the account and all associated e-mail messages.



6. Press Function  + Enter , or tap OK.

After you perform the next HotSync operation, the memory associated with an account and its messages is released.

Selecting a different service for a given e-mail account

When you set up connections on your handheld (in the Connection Preferences screen), you pair each connection with a network service (in the Network Preferences screen) and then select one of these services to be the default for all network activity (sending and receiving e-mail, surfing the Web, and so on) on your handheld. By default, the VersaMail application uses this default service for sending and receiving messages for all e-mail accounts you set up.

However, for any given e-mail account, you have the option of switching to a different service for use with that account only. For example, the default service you have selected for your handheld may be called My GPRS and use a GPRS connection. You may also have set up an e-mail account called My Earthlink, which runs on the My GPRS connection by default. However, if you travel into an area that does not have GPRS coverage, you may want to switch your My Earthlink account to the service called Earthlink GSM, which uses a GSM dial-up connection.

To set up a service for a given e-mail account (different from the default service for your handheld):

1. From the Inbox of the account you want to switch, tap Get Mail.



2. Tap Details.

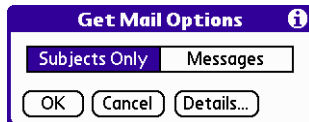

3. Tap the Always connect using check box. A pick list of available services appears. The currently used connection is displayed by default.





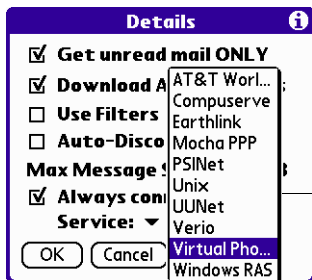

Tap to change the service connection for this e-mail account only from your default handheld service connection

4. Select the connection you want to switch to from the Service pick list.



Select a new service connection for this e-mail account only

5. Press Function  + Enter  (alternately, tap OK), and then press Function  + Enter  (or tap OK) again. If there is an existing service connection, it is disconnected and the new connection is initiated. The VersaMail application sends and checks for any new e-mail using the new connection.

When you exit the VersaMail application, the new service disconnects. When you reopen the application, the e-mail account you selected (My Earthlink in this example) continues to connect using the new connection (Earthlink GSM in this example) until you either select a new service or deselect the Always connect using check box. If you deselect the Always connect using check box, the e-mail account (My Earthlink) connects using the default handheld service (My GPRS in this example).

The Always connect using check box changes the connection service for the selected e-mail account only. You must follow the preceding procedure for each e-mail account whose connection you want to switch from the default connection on your handheld.

Getting, sending, and managing e-mail

Getting and sending e-mail on your handheld is easy and helps you keep your business and personal life organized. You can get and send e-mail by simply tapping one button on the handheld.

You can manage the messages in your e-mail accounts by moving messages between folders, deleting old e-mail messages individually or in groups, and marking messages as read or unread.

This section describes how to do the following:

- Get and send e-mail for your e-mail accounts
- View and send e-mail attachments, such as text or Microsoft Word documents, wirelessly

Getting and reading e-mail

You can get e-mail subjects only—the message size, author, and subject—or you can get entire messages immediately. If you choose to get message subjects only and want to read a full message, you can get more of the message.

Choosing the e-mail account and displaying the Inbox

To view the e-mail in an account, you must switch to that account and then get the e-mail. For example, if you want to collect and view the e-mail from your Yahoo account, you switch to the account created to retrieve e-mail from your Yahoo account.

To display an account and its Inbox:

1. In your Inbox or another folder screen, press Function  + Menu .
2. Select Accounts.

Message Options	Accounts
VersaMail	/1
Sam Yahoo	/2
Sam IMAP	/3
Sam Sync	/4
Account Setup...	/W

3. Press Command  + the number of the account you want from the list.
Alternately, tap the name of the account.
4. Tap the folders pick list, and tap Inbox if the Inbox is not displayed.

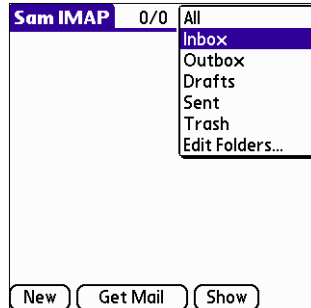

TIP Alternately, you can press the VersaMail button  repeatedly to scroll through the accounts you have configured in the VersaMail application until you get to the account you want.

Getting e-mail by subject or getting the entire message

When you get e-mail messages, you can choose to get the subject only or to get the entire message. You can also use the Details dialog box to select options for getting unread e-mail only, downloading attachments, and using filters.

To get e-mail messages:

1. Tap Get Mail.
If you have e-mail stored in your Outbox, tap Get & Send.
2. In the Get Mail dialog box, tap Subjects Only to download subjects only or tap Messages to download entire messages.

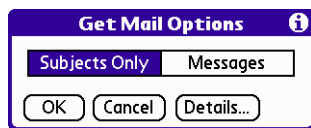



TIP You can turn off the Get Mail dialog box in VersaMail Preferences. See [“Setting preferences for getting and deleting e-mail”](#) later in this chapter.

3. (Optional) Tap Details and select options for retrieving unread e-mail, attachments, using filters, auto-disconnect, maximum download size, and default connection type for this account. Up to ten attachments may be retrieved with a message. Tap OK.

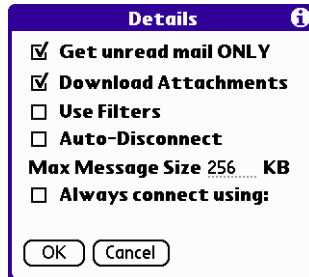
NOTE See “[Setting VersaMail connection preferences](#)” earlier in this chapter for information on the auto-disconnect feature. See “[Selecting a different service for a given e-mail account](#)” earlier in this chapter for information on setting a default connection type. See “[Creating mail filters](#)” later in this chapter for more information about filters.





NOTE The maximum size of an incoming message is 5KB by default.

4. Press Function  + Enter , or tap OK.

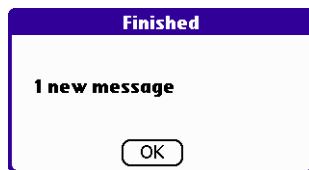
The Getting Messages dialog box shows updates as your e-mail is downloaded. When the Getting Messages dialog box disappears, another dialog box appears and displays the number of new e-mail messages.



5. Press Function  + Enter , or tap OK.

A list of your e-mail appears in the Inbox.

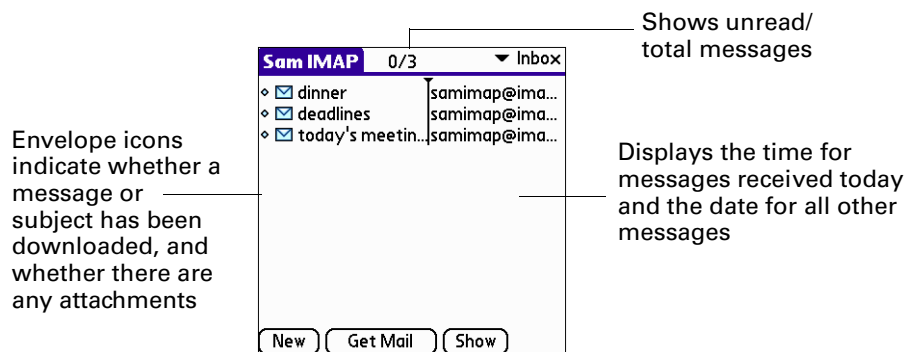

Icons in the VersaMail application

The icons to the left of a message in the Inbox indicate the message's status.



Only the subject header information is downloaded.



Only the subject header and attachment information are downloaded.



Part or all of the message text is downloaded.



Part or all of the message text and attachment information are downloaded.

Reading e-mail

To read e-mail, tap the e-mail message in the Inbox or the folder where the message is located.

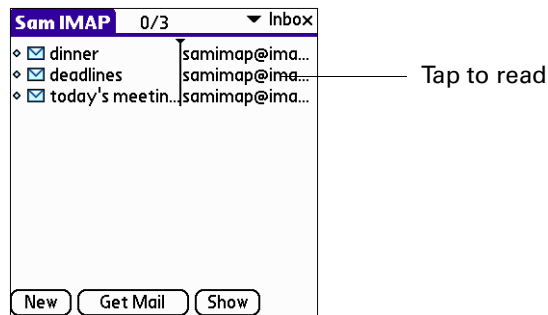

If you chose to get messages by subjects only, tap the More button  to view the body of the e-mail message, plus any attachments. See [“Getting e-mail by subject or getting the entire message”](#) earlier in this chapter.

If you chose to get entire messages, the body of the e-mail message is displayed. However, if the downloaded message exceeds your maximum message size, only a partial message is displayed. Tap the More button to view the entire message.

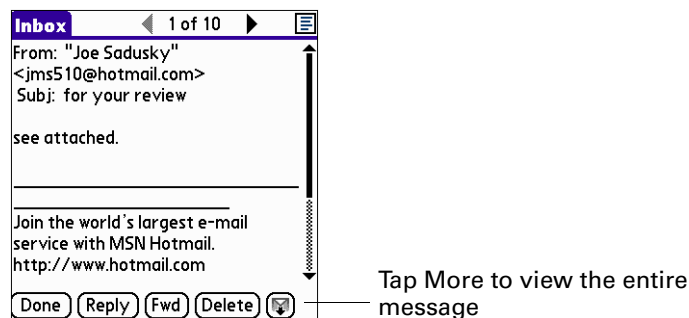

To read a message:

1. Press Up or Down on the navigator to scroll to the message you want to read.
2. Press Select to select the message, and then press Select again to open the message.
3. After reading the message, press Select to close the message.

Viewing other folders

When you get new e-mail, it appears in the account's Inbox folder. You can move e-mail between folders and then view it in the other folder.

To view other folders:

1. Tap the folders pick list in the upper-right corner of the screen.

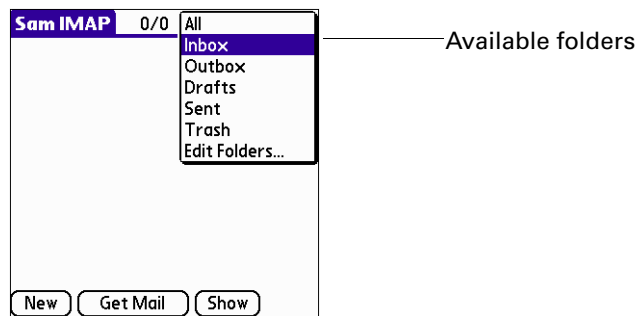

2. Tap the folder you want to view.

Managing columns in the folder's list view

The columns in each folder display various types of information, such as the subject, date, or size of a message. You can display or hide specific columns or change the width of the columns in the folder's list view.

To display or hide a column in a folder's list view:

1. Tap Show.

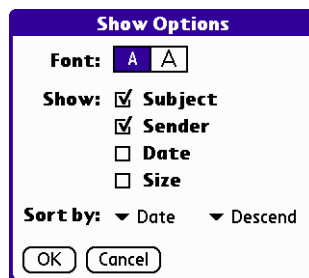

2. Tap the check box for each column that you want to show.

NOTE If you select Date, the Date column displays the message *time* for any messages received today—that is, any message received after 12:01 A.M. Otherwise, the Date column shows the date the message was received.

3. Tap the Font letter to display information in a larger or smaller font size.

To change the sort order:

1. Tap the Sort By pick list, and then tap the column name.
2. Tap Descend or Ascend to change the sort order.

To change the size of a column in the folder's list view:

1. Tap and hold the stylus on the column divider.
2. Drag the column divider to change the width of the column.

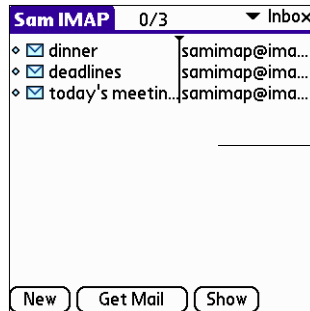

Drag the column divider left or right to make the column narrower or wider

Moving e-mail between folders

You can move one or more e-mail messages between folders.

To move one e-mail message:

1. Press Right on the navigator to move to and open the folders pick list in the upper-right corner of the screen. Press Up or Down to move to the folder you want, and then press Select to select the folder.

Alternately, tap the folders pick list in the upper-right corner of the screen, and then tap the folder name.

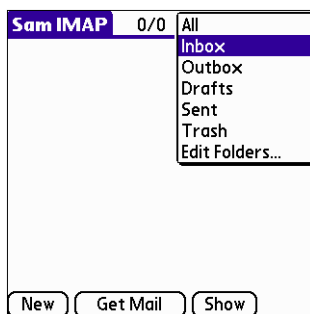

2. Tap the icon to the left of the message, press Right on the navigator to open the Message menu, press Down to move to the Move To option, and then press Select to select this option.

Alternately, tap the icon to the left of the message, and then tap Move To from the pop-up menu.

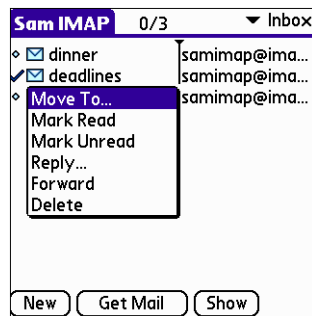

The folders pick list appears.

3. Press Up or Down on the navigator to move to the folder you want, and then press Select to select the folder.

Alternately, tap the folder that you want.

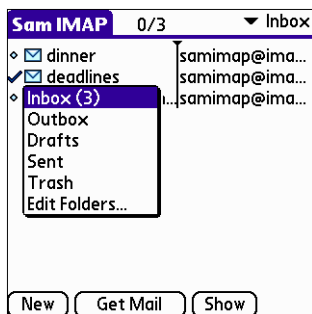

TIP You can also move a single e-mail message from within the body of the message by pressing Command (⌘), tapping the folder icon, and selecting the destination folder from the pick list. See [“Using the command bar”](#) later in this chapter for more information on the command bar.

To move multiple e-mail messages:

1. Tap the folder that contains the e-mail messages you want to move.
2. Select the messages by tapping to the left of each message icon.

TIP To select a group of messages, drag the stylus to the left of the message icons.

A checkmark appears next to the selected messages.

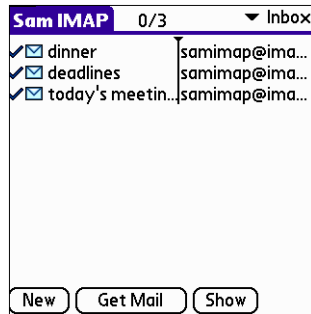

3. Do one of the following:

- Press Command (⌘) + V (alternately, press Function (fn) + Menu (⇧)), and then select Move To on the Message menu.
- Tap a message icon next to a selected message, and then tap Move To on the pick list.

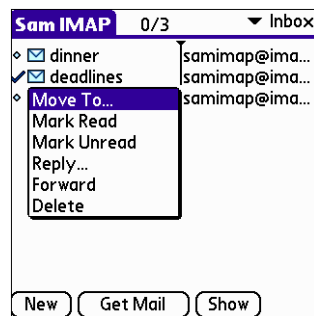

4. Tap the folders pick list, and select a destination folder.

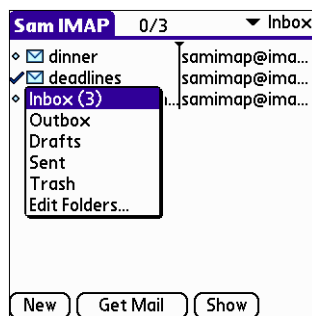

5. Press Function (fn) + Enter (↵), or tap OK.

Creating and editing mail folders

You can also create new folders so that you can store e-mail messages by subject, person, or project. The VersaMail application has certain existing folders, such as Inbox, Outbox, Drafts, and Trash.

The procedure for creating and editing folders varies slightly between POP and IMAP e-mail accounts, as described in the following procedure.

To create and edit e-mail folders:

1. Tap the folders pick list in the upper-right corner of the screen, and then tap Edit Folders.
2. On the Edit Folders or Edit IMAP Folders screen, select any of the following:

POP accounts

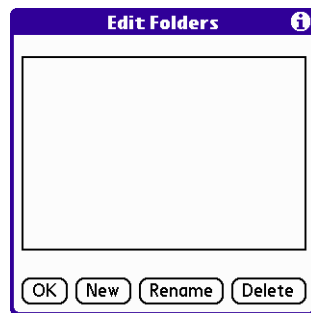

IMAP accounts

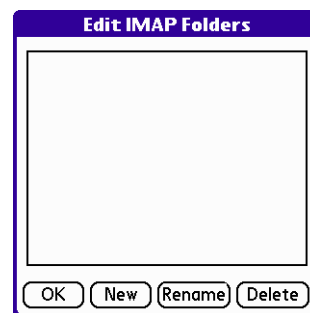

- To create a new folder, tap New, and then enter the new folder name. For IMAP accounts only, select the check box if you also want to create the folder on the server. When finished, press Function + Enter ↵, or tap OK.

POP accounts



IMAP accounts

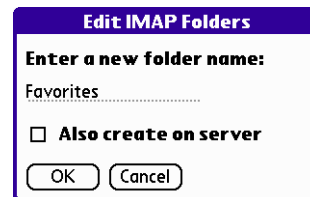

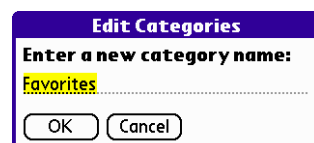

- To rename a folder, tap the folder name from the list on the screen, tap Rename, and then enter the new folder name. For IMAP accounts only, select the check box if you also want to rename the folder on the server. When finished, press Function + Enter ↵, or tap OK.

POP accounts

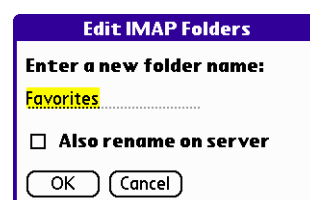

IMAP accounts



- To delete a folder, tap the folder name from the list on the screen, and then tap Delete. For IMAP accounts only, select the check box if you also want to delete the folder on the server, and then press Function  + Enter , or tap OK. For POP accounts, the folder will be deleted immediately and you will not see a confirmation screen.

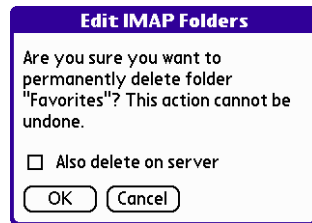

Delete confirmation appears for IMAP accounts only

Creating and sending new e-mail

When you create a new e-mail message, you can enter the person's e-mail address or use the Lookup screen to find a particular address.

To create a new e-mail message:

1. Press Command  + N.

Alternately, tap New.

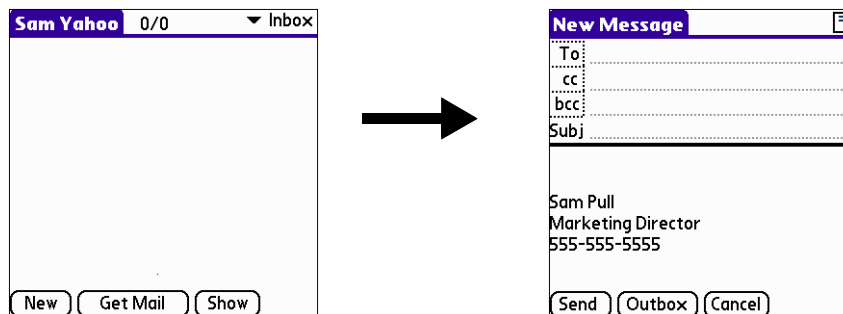

2. Enter the recipient's name using one of the methods described in the next procedures.

NOTE When you address a message to several recipients, you do not see all the recipients on the To list because the list is truncated on the To line. If you tap the To field, a dialog box shows all recipients for the current message.

Addressing a message by typing the address

You can address a message by entering the complete address.

To enter the address:

1. In the New Message screen, tap the To field and enter the address, and then tap Done.

For multiple recipients, type a semicolon (;) and then a space between recipient names.



NOTE If you enter a comma instead of a semicolon, it is automatically changed to a semicolon. If you enter a space with no punctuation between names, semicolons are not inserted and the e-mail message is improperly addressed.

If you want to edit an e-mail address that is longer than the line provided in the New Message screen, tap the To field and edit the address.

2. To send copies, tap cc: or bcc: and enter the recipient's address.

Copies (cc:) allow recipients to see the addresses of the other recipients, but addresses in the blind copies (bcc:) field are hidden from all other recipients.

TIP To automatically fill in the address as you type, see ["Using Smart Addressing to address a message"](#) later in this chapter.

Addressing a message using Address Book

You can enter a recipient's address by using the Lookup screen to select the address. The names and addresses in the Lookup screen come from Address Book.

To use an address from Address Book:

1. In the New Message screen, tap the word To.
2. On the Recipient List screen, tap Lookup.

3. On the Address Lookup screen, tap the address you want, and then tap Add.

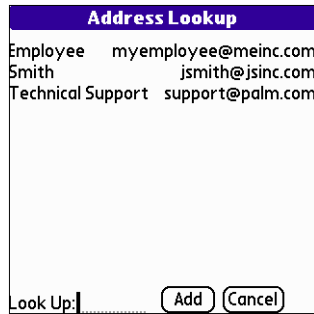

4. Repeat steps 2 and 3 to add more addresses.
5. Tap Done.
6. To enter an address in the cc: or bcc: field, tap the field name and follow the steps given for the To field.

Using Smart Addressing to address a message

Smart Addressing types ahead and completes a recognized e-mail address. Smart addressing automatically fills in fields when the recipient's name and e-mail address are in your Address Book.

By default, Smart Addressing is selected in VersaMail Preferences.

To use Smart Addressing to address a message:

1. In the New Message screen, tap the word To.
2. Start entering the person's name, such as Joe Smith.

Once the name is recognized from your Address Book, the name and e-mail address are automatically completed on the recipient list. For example, if you have a Joe Smith and a Joan Smith in your Address Book (and no other names starting with J), once you type "Joe," the entry "Joe Smith" is completed with the correct e-mail address.

3. Tap Done.

Turning Smart Addressing on or off

You can turn Smart Addressing on or off in VersaMail Preferences. By default, Smart Addressing is turned on.

To turn Smart Addressing on or off in VersaMail Preferences:

1. In the Inbox, press Command (⌘) + R.

Alternately, in the Inbox, press Function (F) + Menu (⌘), tap Options, and then tap Preferences.

2. Tap Advanced.

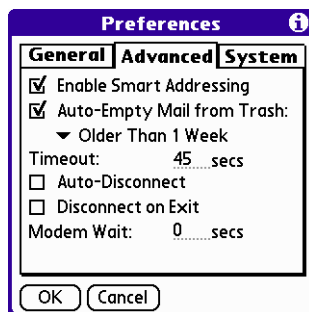

3. Tap the Enable Smart Addressing check box if it is not selected. A checkmark means it is turned on.
4. Press Function (F) + Enter (⏎), or tap OK.

Composing and sending e-mail

After you enter your recipient addresses, you can compose the rest of the e-mail message.

To compose the rest of the e-mail and send it:

1. Tap the Subject field and enter the subject of your e-mail.

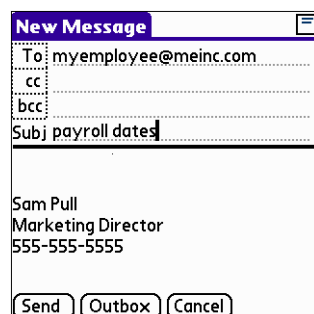

2. Tap the area below the Subject line and enter the text of your e-mail.

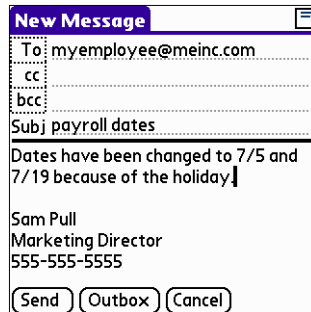

To access the editing features available on the Edit menu, press Function  + Menu . The first character of each sentence is automatically capitalized for you.

3. (Optional) Press Command  + A (alternately, tap the Options menu and select Add Attachments). See [“Attaching files to e-mail”](#) later in this chapter.
4. Tap one of the following to send the e-mail:

Send Sends the e-mail immediately. (Alternately, press Command  + Y.)

Outbox Stores e-mail in the Outbox so you can compose e-mail offline and then send all e-mail during one connection with the server. To send your e-mail later, go to the Outbox and tap Get & Send. The connection to the mail server is truncated and all the e-mail in the Outbox is delivered.

TIP You can also tap Save To Drafts from the Options menu (or press Command  + W) to save this message in the Drafts folder rather than sending it.

Completing drafts

If you are composing an e-mail message and you exit the VersaMail application before tapping Outbox, Send, or Cancel, the e-mail automatically moves to the Drafts folder. To finish editing the e-mail, tap the folders pick list and select Drafts. Select the e-mail you want to complete or edit, and tap Edit. You can also delete the e-mail in the Drafts folder.

Attaching a personal signature

You can include a personal signature, such as your name, e-mail address, and telephone number, to each e-mail you send.

To create a personal signature:

1. Press Command  + R.

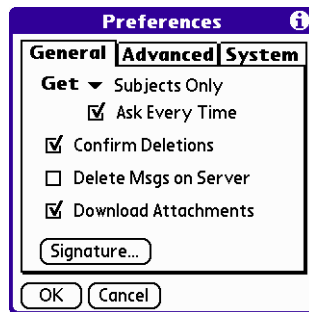

Alternately, press Function  + Menu , tap Options, and then tap Preferences.

2. Tap Signature.

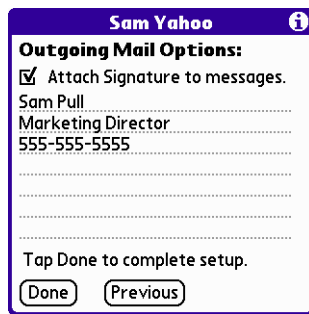

3. Tap the Attach Signature check box to select it.



4. Enter your signature information.
5. Press Function  + Enter , or tap OK.

Forwarding e-mail

You can quickly forward e-mail messages from any folder other than the Outbox folder.

To forward e-mail:

1. Tap the folders pick list and select the folder that contains the e-mail.
2. Tap the e-mail message to display it.
3. Press Command  + F.

Alternately, tap the Forward button.

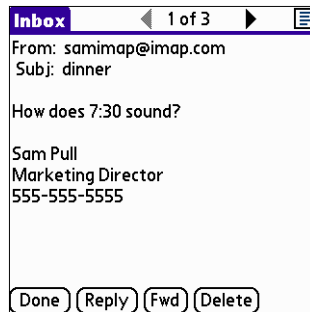

Tap Forward

4. Tap the word To.
5. On the Recipient List screen, enter or look up the recipient address. See the procedure for creating new e-mail earlier in this chapter for more information on addressing messages.

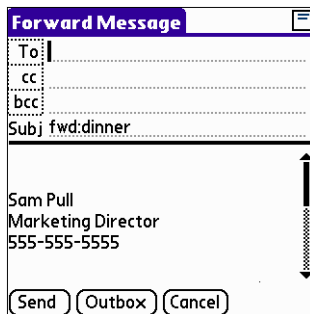

6. (Optional) Enter some text describing the forwarded message.
7. Press Command  + Y (alternately, tap Send) to send the message, or tap Outbox to store it in the Outbox.

Replying to e-mail

You can reply to an e-mail as you are reading it, or start the reply when viewing messages in the folders list view.

To reply to an e-mail that you are reading:

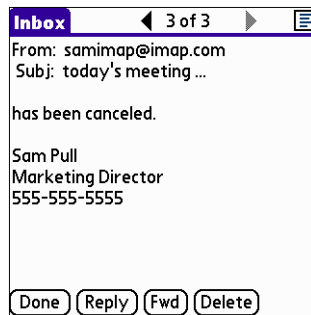

1. Tap the e-mail you want to reply to.
2. Press Command  + O.

Alternately, tap Reply.

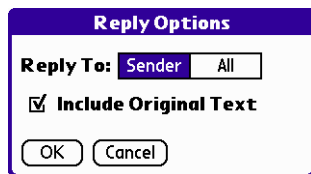

3. In the Reply Options dialog box, select options for replying to the sender only or to all e-mail recipients, and for including original message text.



4. Press Function  + Enter , or tap OK.
5. Enter a reply.

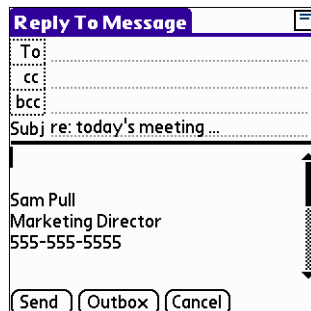

6. Press Command  + Y (alternately, tap Send) to send the message, or tap Outbox to send it later.

To reply to an e-mail from the folders list:

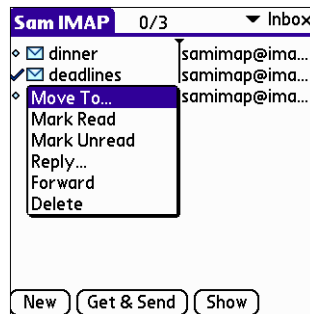

1. On the message screen, press Right on the navigator to move to and open the Options menu.
2. Press Down on the navigator to move to the Reply option, and then press Select to select this option.

TIP Alternately, you can tap the folders pick list, select the folder that contains the e-mail, tap the envelope icon next to the message, and then tap Reply on the pick list.

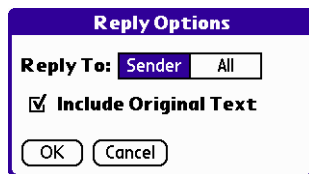

3. In the Reply Options dialog box, select options for replying to the sender only or to all e-mail recipients, and for including original message text.



4. Press Function  + Enter , or tap OK.
- The e-mail is addressed.
5. Enter a reply.

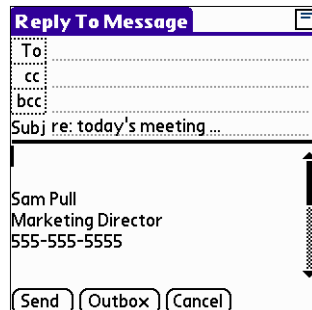

6. Press Command  + Y (alternately, tap Send) to send the message, or tap Outbox to send it later.

Working with attachments

You can easily download, view, and send attachments with e-mail messages.

Viewing attachments on your handheld

At times e-mail contains attached files, such as Microsoft Word or text files, that you want to view on your handheld. You can view the following attached files:

vCard (.vcf)	This is an address.
vCal (.vcs)	This is usually a calendar appointment or a To Do task.
Text (.txt)	This is usually a memo or another plain text file.
HTML (.html or .htm)	Usually a web page or a formatted text file. By default, the VersaMail application strips the formatting and shows only the text of most HTML attachments. However, some browsers allow other applications to pass them a file for viewing in full HTML. If your browser supports this function, you can view HTML attachments with all formatting intact. You do not need to do anything different in the steps for downloading and viewing attachments; the attachment is automatically opened in the correct format for your handheld (text only or full HTML) based on the applications you have installed.
Microsoft Word (.doc)	The formatting is stripped and shows the text of most Microsoft Word documents is shown.
Other application files (such as graphics files)	For other types of application files, your handheld may contain a viewer that allows other applications to pass it a file for viewing. For example, your handheld may contain an image viewer that allows another application to pass it a JPEG or GIF attachment for viewing. You do not need to do anything different in the steps for downloading and viewing attachments; if your handheld contains such a viewer, the attachment is automatically opened. If your handheld does not contain such a viewer, you cannot view the attachment.
PRC (.prc)	This is a Palm OS® application that you can install and run on your handheld.
PDB (.pdb)	This is a file that works with specific Palm™ applications.

Among the types of attachments you can receive are the following handheld application files:

- Address Book entries
- Date Book appointments
- To Do list items
- Memos

NOTE The maximum message size that you can retrieve is 60KB for the body text and 2MB total, including attachments. If the attachment is too large, it cannot be downloaded to the handheld.

To view an attachment:

1. In the Inbox, tap the message with the attachment.

A paper clip icon appears on the message's icon if the message has an attachment that has been downloaded.

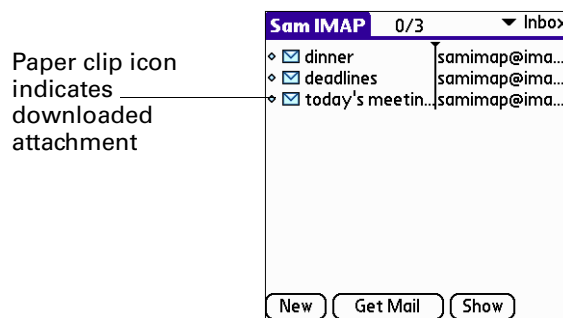

If you choose to get messages by subject only, you must tap More for each downloaded message in order to view the body of the e-mail message plus any attachments.

If the option Download Attachments is selected in the VersaMail Preferences, any attachments that do not cause the message to exceed the maximum message size are downloaded. Otherwise, you see a message showing that the attachments were too large and asking if you would like to continue downloading them.

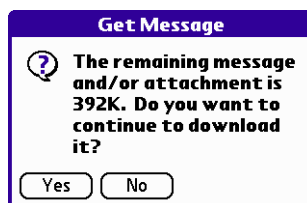

For example, if the maximum message size is 5KB and you download a body of 2KB, then any attachment under 3KB is also downloaded, and any attachment over 3KB is not. See [“Downloading large attachments”](#) later in this chapter.

If an attachment is not downloaded, the message will not show a paper clip icon in the Inbox even though it was sent with an attachment.

- Click the paper clip icon in the upper-right corner. If the attachment is not downloaded, a paper clip icon will not appear even though the message was sent with an attachment. You must download the attachment for the paper clip icon to appear.

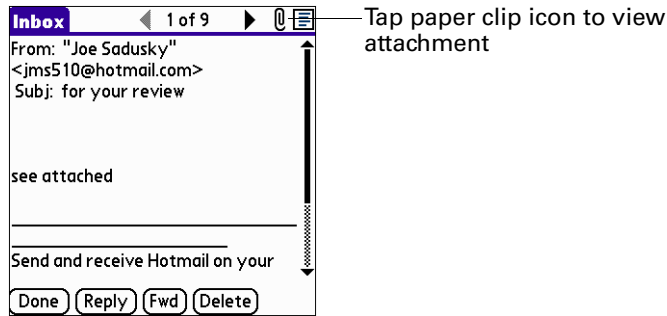

- Tap the name of the attachment you want to view, and tap View.

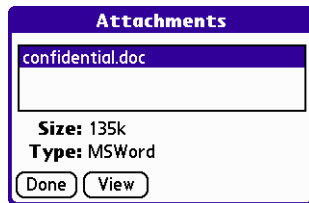

- When you have finished viewing the attachment, tap Done. This returns you to the Attachments dialog box, where you can select another attachment to view if you want to.
- When you have finished viewing all attachments, tap Done on the Attachments dialog box. This returns you to the Message screen.

Downloading large attachments

Downloading and viewing a message with a single attachment that exceeds your maximum message size, or a message with multiple attachments whose total size exceeds your maximum message size, requires some extra steps.

To determine if a message has an attachment or multiple attachments that exceed the maximum message size:

- In the Inbox, tap the message title.



More button indicates that message plus any attachments exceeds maximum message size

If the message plus attachments exceeds the maximum message size, the More button  appears on the Message screen. In the case of multiple attachments, if some of the attachments were downloaded completely, you see both the paper clip icon (indicating fully downloaded attachments) and the More button (indicating incompletely downloaded attachments).

To download a single attachment that exceeds the maximum message size:

1. Tap the More button.



Tap More

2. Tap No to stop downloading and return to the Message screen.
Tap Yes to continue downloading the entire message with attachment.

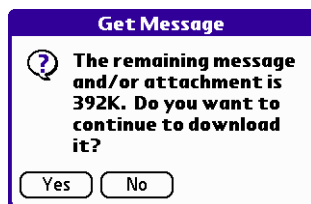

3. (Optional) Tap Cancel to stop downloading and return to the Message screen.

When downloading is complete, the paper clip icon appears and the More button is no longer displayed. Follow the procedure for viewing an attachment presented earlier in this chapter.

To download multiple attachments whose total size exceeds the maximum message size:

1. Tap the paper clip icon.

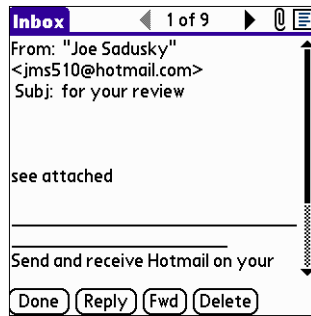

2. Select one of the following:

- To return to the Message screen, tap Cancel.
- To view any fully downloaded attachments without continuing to download additional attachments, tap No.

Follow the procedure for viewing an attachment presented earlier in this chapter.

- To continue downloading all messages, tap Yes.

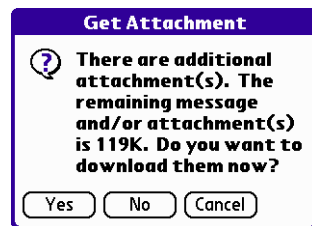

3. (Optional) Tap Cancel to stop downloading and return to the Message screen.

When downloading is complete, the Attachments dialog box appears, showing all downloaded messages. Follow the procedure for viewing an attachment presented earlier in this chapter.

Attaching files to e-mail

You can attach files on your handheld to e-mail messages you send. For example, you can attach files from the various handheld applications, such as any Date Book appointment (.vcs), To Do List tasks (.vcs), or memos (.txt).



NOTE The maximum size message you can send is 60KB for the body text and 2MB total, including attachments. The maximum number of attachments for any e-mail is ten, regardless of the attachments' total size.

You can attach the following types of files:

- vCard (.vcf)
- vCal (.vcs)
- Memo/Text (.txt)
- PRC (.prc)
- PDB (.pdb)

To attach a file to a message:

1. Press Command  + A.

Alternately, press Function  + Menu , tap Options, and then tap Add Attachment.



2. Tap the Type pick list and select the file type.

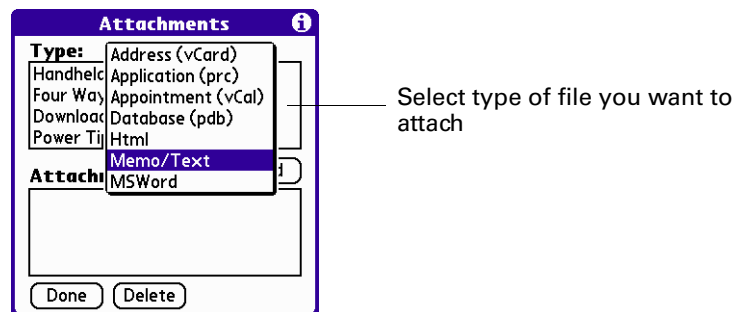

All files of the selected type appear in the Type box. For example, if you select Appointments (vCal), tap Date Book to see a list of appointments from a particular date that you can attach, or tap To Do to see To Do List tasks.

3. Tap the file that you want to attach, and then tap Add.

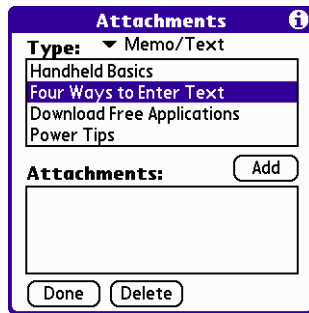

The selected file appears in the Attachments box.

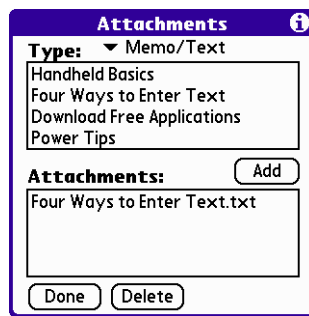

4. Repeat steps 4 and 5 to for each attachment you want to add, and then tap Done.

TIP To delete an attachment from an e-mail message, tap the attached file in the Attachments box and then tap Delete.

5. Tap Send or Outbox.

Forwarding an attachment

You can include an attachments on any message you forward, up to the maximum message size.

To forward a message with an attachment:

1. Tap the folders pick list and select the folder that contains the e-mail.
2. Tap the e-mail message to display it.
3. Press Command (⌘) + F.

Alternately, tap the Forward button.

4. Tap the word To. On the Recipient List screen, enter or look up the recipient address. See the procedure for creating e-mail earlier in this chapter for more information on addressing messages.
5. Follow the steps for the procedure for attaching files presented earlier in this chapter.

Deleting messages

You can delete one or more e-mail messages from any folder. For example, you can delete old messages in the Inbox or messages that you were working on in the Drafts folder. When you delete a message, it is placed in the Trash folder. See [“Emptying the trash”](#) later in this chapter.



To delete messages on the server when you empty the trash on your handheld, you can select the Delete Msgs on Server setting in VersaMail Preferences. If you don't periodically empty the trash and delete messages on the server, any incoming e-mail may “bounce” back to the sender. See [“Setting preferences for getting and deleting e-mail”](#) later in this chapter.

To delete one or more messages:



1. Tap the folders pick list and select the folder that contains the message you want to delete.
2. Do one of the following:

Item to delete	Action
One message	Tap the bullet next to the message's icon.
Multiple messages	Tap the bullet next to the icon of each message that you want to delete.
A group of adjacent messages	Drag the stylus along the left of the message icons. To select another group, lift the stylus and select the next group of messages.

3. Press Right on the navigator to move to and open the Message menu.
4. Press Down on the navigator to move to the Delete option, and then press Select to delete the message.

TIP Alternately, you can tap the message icon next to a selected e-mail message and then tap Delete, or press Function  + Menu  and then select Delete.

Message	Options	Accounts
Select All	/S	
Deselect All	/Z	
<hr/>		
New Message	/N	
Get Message	/M	
Move To...	/V	
Mark Read	/H	
Mark Unread	/I	
<hr/>		
Delete	/D	
Delete Old...	/O	
Empty Trash	/E	

5. Press Function  + Enter , or tap OK.

- (Optional) Tap Also delete message on server if you want to delete the message from the server now.



If you selected the setting Delete Msgs on Server in VersaMail Preferences, this check box is selected

The selected messages move to the Trash folder and are deleted from your handheld when you empty the trash. If you set the preference to automatically empty the trash, the messages are deleted when the trash is emptied. By default, the trash auto-empties all deleted e-mail older than one week. See “Emptying the trash” later in this chapter for more information.

IMPORTANT If you delete a message on the server, you cannot retrieve it and view it again later.

To delete messages before a certain date:

- Press press Function + Menu , and then tap Delete Old from the Message menu.

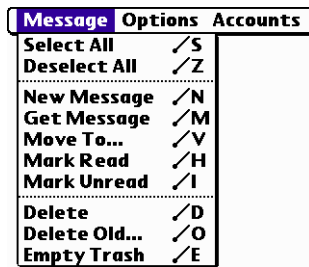

- Tap the Folder pick list and select the folder that contains the messages you want to delete.



Displays the current folder for deleting messages

- Tap the Older than pick list, and then tap One Week, One Month, or Choose Date.



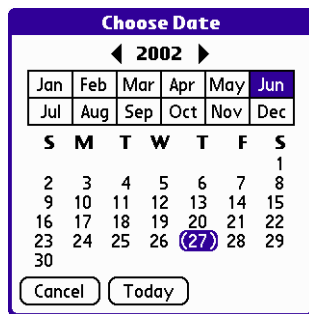

If you tap Choose Date, you can select a date from the calendar.



Tap a date to select it, or tap Today

- Tap Delete.
- (Optional) Tap Also delete message on server if you want to delete the message from the server now.





- Press Function  + Enter , or tap OK.

Emptying the trash

Deleted e-mail accumulates in the Trash folder and takes up space on your handheld. To increase memory, you should empty the trash regularly. If you want to automatically empty the trash, you can set a preference to empty the trash immediately or empty any e-mail older than a certain number of days.

To empty the trash:

1. Press Command  + E.

Alternately, press Function  + Menu , and then select Empty Trash from the Message menu.



NOTE If Auto-Empty Mail from Trash is selected in VersaMail Preferences, a message asks if you want to delete the trash.

2. (Optional) Tap Details to see how many messages are in the Trash, and whether the messages are set to be deleted on the server.

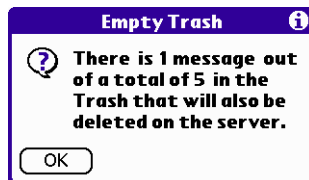



3. If you want to delete messages from the handheld as well as from the server, tap Both. A message asks if you want to update the server now.

To delete the message from only the handheld now, tap Handheld.

NOTE Many e-mail providers, such as Yahoo, have size restrictions for mail storage. If your mailbox on the server becomes full, messages are returned to the senders.

To have the trash emptied automatically:



1. Press Command  + R.

Alternately, press Function  + Menu , select Options, and then select Preferences.

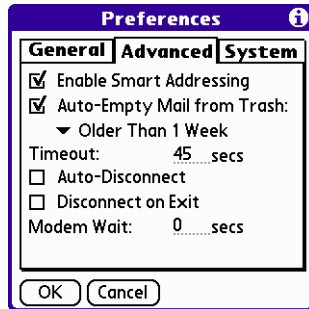
2. Tap Advanced.



By default, Auto-Empty Mail from Trash is selected, and the time interval is set at Older Than 1 Week.

3. Tap the pick list, and select how often you want the e-mail messages automatically emptied from the trash.
 - Immediately.
 - Older Than 1 Day.
 - Older Than 3 Days.
 - Older Than 1 Week.
 - Older Than 1 Month.
4. Press Function  + Enter , or tap OK.

Marking messages as read or unread

You can mark messages as read or unread. When you tap a message to read it, it is automatically marked as read.



NOTE Because POP servers do not support the read or unread message feature, the message is in bold or regular typeface for POP accounts on the handheld, but you can't connect with the server to change the message state.

To mark messages as read or unread:

1. Tap the folders pick list and select the folder you want.
2. Tap the icon next to the message you want to mark.

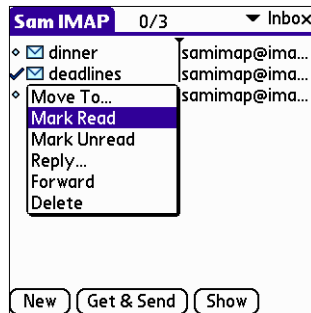
3. Tap Mark Read or tap Mark Unread.



TIP To mark multiple messages, tap the bullets next to the messages you want, press Function  + Menu  and then select Mark Read or Mark Unread.

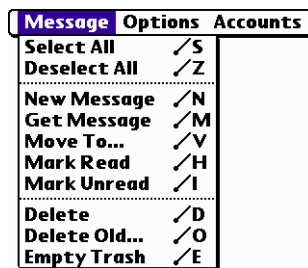

4. Tap Handheld to mark the messages as read or unread on your handheld. Tap Both to mark the messages on both the handheld and the server.

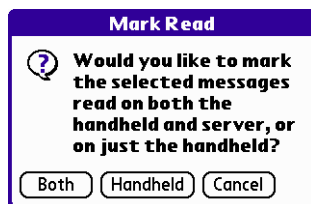

If you tap Both, this message appears.



Tap OK to connect with the server and immediately mark the messages as read or unread on the server. This action also processes any other pending actions on the server, such as messages not yet deleted.

Tap Cancel if you want the messages marked during the next HotSync operation or the next time you connect to the server.

Read messages appear in plain text; unread messages appear in bold text.

Setting preferences for getting and deleting e-mail

VersaMail Preferences determine how the VersaMail application gets, sends, and deletes e-mail.

To set e-mail preferences:

1. Press Command  + R.

Alternately, press Function  + Menu , select Options, and then select Preferences.

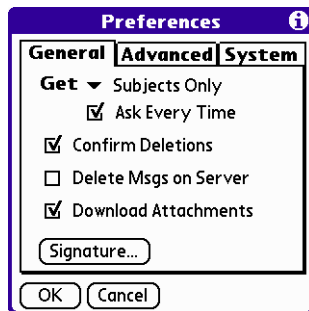

2. Select preferences:



Get	Enables you retrieve the subject only or the entire message.
Ask Every Time	Displays a dialog box for choosing subjects only or entire messages each time you retrieve e-mail. If deselected, messages are retrieved according to the option you select in the Get pick list.
Confirm Deletions	Displays a confirmation dialog before deleting e-mail.
Delete Msgs on Server	If selected, automatically deletes messages on the server that you have deleted on your handheld. If not selected, you will be asked each time you delete messages on your handheld whether you want to also delete them on the server. Because mailboxes on the server usually have size restrictions, we recommend periodically deleting messages on the server.

- Download Attachments** Causes files attached to e-mail to be automatically downloaded to your handheld. Attachments that exceed the maximum message size cannot be downloaded. See [“Working with attachments”](#) earlier in this chapter for more information.
- Signature** Enables you to attach a default signature to all your outgoing messages. See [“Attaching a personal signature”](#) earlier in this chapter for more information.

Adding or updating an Address Book entry directly from a message

You can add or update an e-mail address in the Address Book directly from the body of a received e-mail message.

To add a new Address Book entry:

1. On the Message screen, press Function  + Menu , select Options, and then select Add to Address Book.

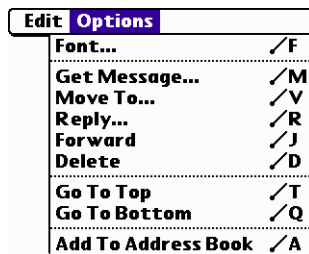

A dialog box appears with the “From” address displayed. If a Display Name exists for this Address Book entry, the Last name and First name fields show the display name.

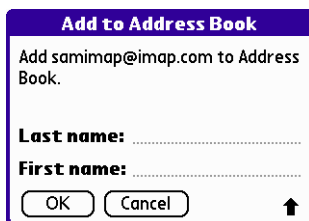

2. (Optional) If the Last name and First name fields are blank, enter the first and last name associated with the “From” e-mail address.
3. Tap OK to add the e-mail address to the Address Book, and then tap OK in the confirmation dialog box.

You can also update an existing Address Book entry with a new e-mail address, or create a second Address Book entry for a name that has an existing record. The procedure is the same as for adding a new Address Book entry. If you tap Add to Address Book from the body of an e-mail message and a record already exists for the recipient name, you are prompted either to update the e-mail address for the recipient or to create a new record for the recipient.

Synchronizing e-mail between the handheld and the desktop

To manage your e-mail on your desktop as well as on your handheld, you can synchronize an e-mail account on the handheld with an e-mail application on the desktop. You can use many popular e-mail applications, called *clients*, such as Microsoft Outlook, Eudora, Lotus Notes, Outlook Express, or any other e-mail clients that use MAPI.

You must have a Windows computer to synchronize e-mail between your handheld and your computer.

This section describes the following:

- Starting the Palm VersaMail HotSync Conduit
- Configuring and activating accounts in the HotSync Manager
- Synchronizing e-mail on the handheld with a desktop e-mail application
- Converting attached files using attachment conversion plug-ins

Configuring an account in HotSync Manager

Before synchronizing an e-mail account, you configure the account's settings in the Palm VersaMail HotSync Conduit. The settings have to be specified only once unless you need to make changes.

To start Palm VersaMail HotSync Conduit:

1. Click the HotSync Manager icon  in the Windows system tray.
2. Select Custom.
3. Select VersaMail in the Conduit list.

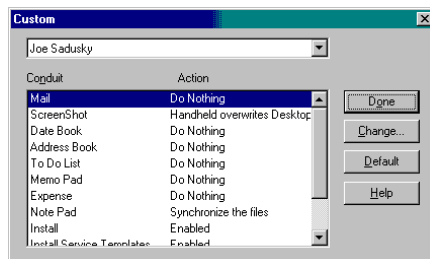

4. Click Change.
5. Select Synchronize Active Accounts.

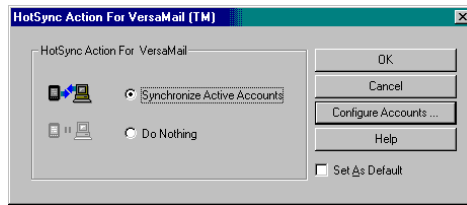

Curly accesses POP servers through MAPI only, and accesses IMAP servers through configuration in MultiMail

Setting synchronization options and account settings

Next, you must configure each e-mail account's general synchronization settings. For example, if you created an Earthlink e-mail account on the handheld and want to synchronize that with the desktop, set the synchronization options for the Earthlink account. During a HotSync operation, the Earthlink account on the handheld and the e-mail application specified in the conduit are synchronized.

To configure an account and set the synchronization options:

1. In the HotSync Action For VersaMail dialog box, click Configure Accounts.

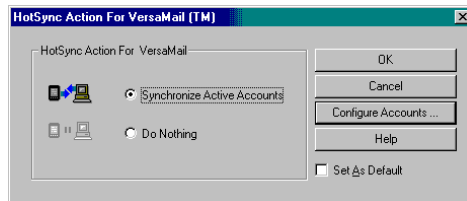

- (Optional) Select the check box Enable Informational Logging if you want the HotSync log to record information, such as errors encountered, about the conduit during a HotSync operation.

Select the account to configure and synchronize

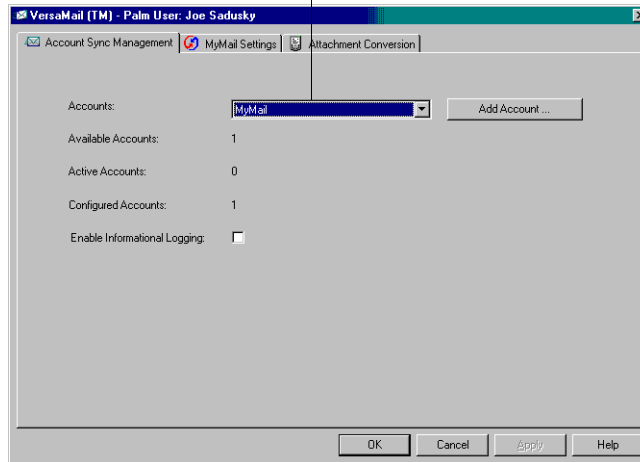

- Select the account that you want to configure from the Accounts drop-down list.

The tab with the account's name and settings, such as MyMail Settings or Yahoo Settings, is displayed.

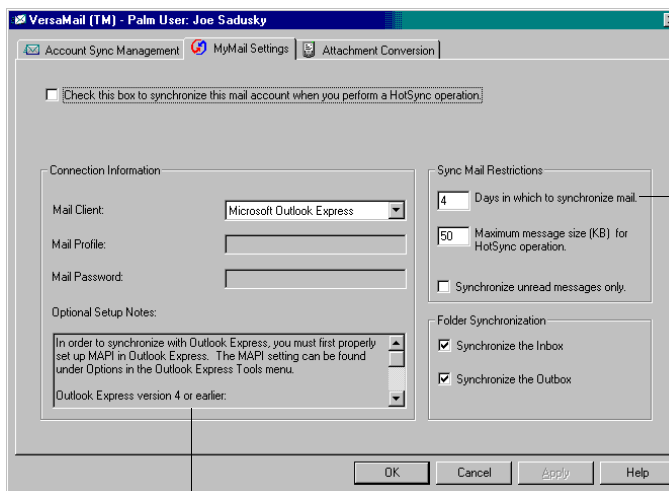

Enter the message size and the number of days before today that synchronization occurs

Check here for helpful notes when configuring an e-mail client

- Select the option Check this box to synchronize this mail account when you perform a HotSync operation; otherwise, the account cannot be synchronized.
- Under Connection Information, select the desktop e-mail application, such as Microsoft Exchange 5.0 or later, Outlook Express, or Eudora, that you are synchronizing the account with and specify any necessary settings.

TIP If your e-mail application is compatible with Extended MAPI, try Microsoft Exchange 5.0 or later as a choice for the Mail Client option. If your e-mail application is compatible with Simple MAPI (SMAPI), try Microsoft Outlook Express as a choice for the Mail Client option. Although Netscape uses SMAPI, Netscape is not supported.

Mail Client	Action
Microsoft Exchange 5.0 or later	Select a MAPI profile to access the mail server. The conduit displays any existing MAPI profiles in the list.
Microsoft Outlook 97 or later	Select the MAPI profile to access the mail server. The conduit checks for any existing MAPI profiles and displays them in the list. Enter your password for Outlook. See “Configuring Microsoft Outlook” later in this chapter for the changes you need to make in Outlook.
Microsoft Outlook Express 5.5 or later	If you select Microsoft Outlook Express, enter the password for your e-mail account. See “Configuring Microsoft Outlook Express” later in this chapter for details.
Lotus Notes	Enter your Lotus Notes ID and password. Click Browse if you need to locate your Notes ID.
Eudora 5.0 or later	See “Configuring Eudora” later in this chapter for more information about the settings to make in Eudora.
Direct POP connection to server	<p>Select this option to synchronize an account by connecting directly with a POP server. You must enter the information about the server in the VersaMail application on your handheld when you create the e-mail account to access the server. You will enter information about the incoming (POP) server, outgoing (SMTP) server, your e-mail username, your password, and your e-mail address.</p> <p>During the HotSync operation, the conduit reads the settings you made. If the settings do not exist or all server information is wrong, an error is reported in the HotSync.log file. However, if the incoming server (POP) is correct, the Inbox is synchronized if the option to synchronize the Inbox is selected. If the outgoing server (SMTP) is correct, the Outbox is synchronized (send e-mail) if you selected the option to synchronize the Outbox. If neither is correct, then nothing happens.</p>

Mail Client	Action
	<p>If you want to synchronize e-mail for an account that requires APOP authentication, you must select the option to use APOP on your handheld. See “Adding APOP to an account” later in this chapter for details.</p>
	<p>If you want to synchronize e-mail for an account that requires ESMTP authentication (for example, Yahoo accounts require ESMTP authentication), you must select the option to use ESMTP on your handheld. See “Adding ESMTP to an account” later in this chapter for details.</p>
Direct IMAP connection to server	<p>Select this option to synchronize an account by connecting directly with an IMAP server. You must enter the information about the server in the VersaMail application on your handheld when you create the e-mail account to access the server. You will enter information about the incoming (IMAP) server, outgoing (SMTP) server, your e-mail username, your password, and your e-mail address.</p> <p>During the HotSync operation, the conduit reads the settings you made. If the settings do not exist or all server information is wrong, an error is reported in the HotSync.log file. However, if the incoming server (IMAP) is correct, the Inbox is synchronized if the option to synchronize the Inbox is selected. If the outgoing server (SMTP) is correct, the Outbox is synchronized (send e-mail) if you selected the option to synchronize the Outbox. If neither is correct, then nothing happens.</p> <p>If you want to synchronize e-mail for an account that requires ESMTP authentication (for example, Yahoo accounts require ESMTP authentication), you must select the option to use ESMTP on your handheld. See “Adding ESMTP to an account” later in this chapter for details.</p>
Other e-mail applications	<p>Select Microsoft Exchange 5.0 or later as a choice for the Mail Client option if your e-mail application is compatible with extended MAPI. If your e-mail application is compatible with SMAPI, select Microsoft Outlook Express as a choice for the Mail Client option.</p>

NOTE A profile contains configuration information, such as the location of incoming e-mail, your personal address book, and other information services that you can use. The profile may be MS Exchange Settings, your name, or something different. For more information on profiles, see your e-mail application’s documentation.

6. Enter the Sync Mail Restrictions you want:
 - **Days in Which to Synchronize Mail:** Set how many days of e-mail, between 0 and 999, that e-mail should be synchronized. A value of 0 synchronizes all e-mail in the Inbox during the next HotSync operation. For other values, the conduit synchronizes e-mail for today and the number of days preceding today. For example, if you enter a value of 2, e-mail is synchronized for today and yesterday, but if you enter 3, e-mail is synchronized for today, yesterday, and the day before.
 - **Maximum Message Size (KB) for HotSync Operation:** Enter the maximum message size from 1 to 2048KB. If the message exceeds the maximum size, the conduit truncates the message. For example, the maximum message size might be 50KB, and the message might have the following:

Message header	1KB
Body	20KB
Attachment 1	40KB
Attachment 2	20KB

In this case the conduit puts the message header, body, and attachment 2—totaling 41KB—on the handheld. Attachment 1 is removed because adding it to the message causes the message to exceed the maximum.

- **Synchronize unread messages only:** Select whether to synchronize all e-mail between your desktop and your handheld, or unread e-mail only. By default, the check box is unselected, meaning that all e-mail will be synchronized.
7. Select the folder synchronization you want:
 - Select the Synchronize the Inbox check box to synchronize the Inbox during the next HotSync operation.
 - Select the Synchronize the Outbox check box to send any e-mail in the handheld's Outbox during the next HotSync operation.
 8. Click Apply.

Verifying handheld account settings before synchronizing accounts

Certain settings you configure on your handheld for a given e-mail account must be set correctly for the synchronization process as well. Before configuring an e-mail client on your desktop for synchronization, be sure to verify the following settings on your handheld:

- **APOP and ESMTP:** If you want to synchronize e-mail for an account that requires either APOP or ESMTP authentication (for example, Yahoo accounts require ESMTP authentication), you must select the option to use APOP or ESMTP on your handheld. See [“Adding APOP to an account”](#) and [“Adding ESMTP to an account”](#) later in this chapter for details.
- **Mail filters:** Any mail filters you have configured for a given e-mail account on your handheld also apply during the synchronization process. For example, if you have set filters to accept only e-mail containing the subject words “Current Software Project,” only those same messages are synchronized between your desktop and your handheld. Be sure to turn mail filters off if you want to synchronize all messages between your desktop and your handheld. See [“Turning filters on and off”](#) later in this chapter for details.

Configuring Microsoft Outlook

You can synchronize Microsoft Outlook 97/98/2000/XP with a VersaMail e-mail account, but you must set Microsoft Outlook as the default e-mail handler. You must check your username and password.

To configure Microsoft Outlook:

1. In the Control Panel, click Internet Options.

NOTE For Windows XP, click Network and Internet Connections, and then click Internet Options.

2. Click the Programs tab.
3. Select Microsoft Outlook as the default e-mail program.
4. Click OK.

NOTE Make sure your username and password are set up correctly within Microsoft Outlook.

Configuring Microsoft Outlook Express

You can synchronize a VersaMail e-mail account with Microsoft Outlook Express 5.5 or 6.0, but you must set Outlook Express as the default e-mail handler.

NOTE Make sure your username and password are set up correctly within Outlook Express.

To configure Outlook Express:

1. In the Control Panel, click Internet Options.

NOTE For Windows XP, click Network and Internet Connections, and then click Internet Options.

2. Click the Programs tab.
3. Select Outlook Express as the default e-mail program.
4. Click OK.

TIP You can also make Outlook Express the default e-mail handler within the e-mail application. From the Tools menu, select Options. Click the General tab, and then click Make Default.

Configuring Eudora

If you are using Eudora as your e-mail application, you must set up MAPI in Eudora.

To set up MAPI in Eudora:

1. From the Eudora Tools menu, select Options.
2. Do one of the following:
 - If Eudora is the only e-mail application that you use, select Always as the MAPI setting.
 - If you use more than one e-mail application, select When Eudora is running as the MAPI setting.
3. Ensure that your username and password are set up correctly within Eudora. This information is needed to log in to Eudora to retrieve and synchronize your e-mail.

IMPORTANT Eudora must be running in order for you to perform a HotSync operation. The VersaMail application synchronizes with your Dominant Personality in Eudora 5.1 or later.

Converting attached files

You can use attachment conversion plug-ins to convert attached files that you are receiving. Documents To Go plug-ins are automatically configured; however, you must install Documents To Go version 5 on your desktop computer and on your handheld for attachments to be converted properly. Version 5 of Documents To Go is included on the Software Essentials CD-ROM that came with your handheld. See the *Documents To Go Getting Started Manual* for more information.

When you receive a message with an attachment on your handheld, the file is converted to the DataViz format on the handheld when you perform a HotSync operation. You can then read and edit the file in Documents To Go on the handheld.

In the Palm VersaMail HotSync Conduit, you can turn off DataViz Documents To Go plug-ins or select other plug-ins.

To turn off attachment conversion plug-ins:

1. Click the HotSync Manager icon  in the Windows system tray.
2. Select Custom.
3. Select VersaMail in the Conduit list.

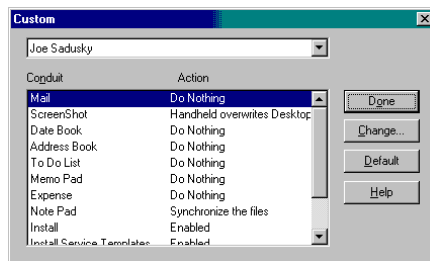

4. Click the Attachment Conversion tab.

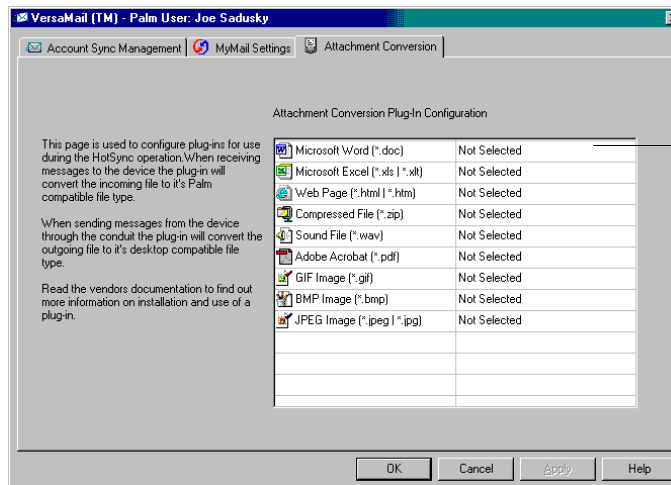

Documents To Go plug-ins are configured automatically

5. To deselect a plug-in, select Not Selected from the drop-down list. To select a plug-in, select Selected from the drop-down list.
6. Click OK.

Synchronizing an account

To synchronize accounts, you must set the HotSync action for the VersaMail application in the HotSync Manager. You can, however, exclude e-mail accounts from a HotSync operation.

TIP If you don't want an account synchronized, deselect the check box **Select this check box to synchronize this e-mail account when you perform a HotSync operation.**

To select which accounts are synchronized during a HotSync operation:

1. Click the HotSync Manager icon  in the Windows system tray.
2. Select Custom.
3. Select VersaMail in the Conduit list.

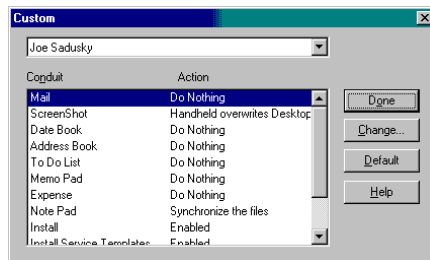

4. Click Change.

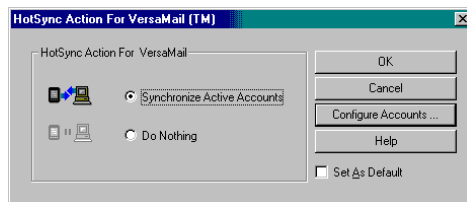

5. Select one of the following:
 - **Synchronize Active Accounts:** Select this option to include active accounts in the next HotSync operation. For an account to be synchronized, you must have selected the option **Check this box to synchronize this mail account when you performed a HotSync operation.**
 - **Do Nothing:** Select this option to exclude e-mail accounts from the next HotSync operation.
6. (Optional) Select **Set as Default** to apply the options you selected to all subsequent HotSync operations. Otherwise, the settings apply to the next HotSync operation only.
7. Click OK.
8. Perform a HotSync operation.

Going beyond the basics

Many of the VersaMail application features, such as getting and sending e-mail, you use daily. Other features are used less frequently but are especially valuable in certain situations. For example, filtering e-mail is helpful if you are traveling and want to receive messages only from certain people or about specific subjects. Filters and other special features are discussed in this chapter.

This section describes the following:

- Creating and using filters to determine which e-mail you actually view
- Managing mail settings
- Adding APOP to an account
- Adding ESMTP to an account
- Copying text from an e-mail message for use in other applications
- Using the command bar
- Viewing e-mail header details
- Backing up your mail databases
- Synchronizing IMAP folders wirelessly
- Accessing corporate e-mail
- A summary of the VersaMail application navigator controls and keyboard shortcuts

Setting server options for an IMAP account

To set mail retrieval server options for an IMAP account:

1. Tap Next.



2. If you want only unread mail to be downloaded to your handheld, make sure Get unread mail ONLY is selected. If you don't choose this option and you tap Get & Send, all e-mail in your Inbox is downloaded.
3. Tap More.

4. If you want to limit the maximum size of an incoming e-mail message, tap the maximum size field and enter the size in kilobytes.



5. Tap the check box to delete messages on the server when they are deleted in MultiMail Deluxe.

If you are selecting this option for an account you created, such as a Yahoo or Earthlink account, the messages are deleted the next time you access your Yahoo account on the web.

6. Tap OK.
7. Tap Finish.
8. Tap Done.

Managing mail filters

Filters provide efficient ways to manage e-mail retrieval and storage. When you tap Get Mail or Get & Send, filters determine which e-mail messages are downloaded to your handheld and in which folder the downloaded messages are stored.

For example, you may want to file e-mail about sales meetings in a Sales folder. You can create a filter that automates this action, so that whenever you receive e-mail about sales meetings, it is immediately sent to the Sales folder, which you created in the filters screen.

Creating mail filters



To create a mail filter, you select various criteria, such as To, From, and Contains. This information makes up the filter statement.

For example, if you want stock quotes from your online brokerage service sent to a specific folder, you can filter those e-mail messages and store them in the Inbox

folder. The filter statement, which is displayed in the Filter Editor, is shown in the following figure.



To create a filter:

1. Press Function  + Menu .
2. Select Options, and then select Filters.
3. Tap New.
4. Enter a short description of the filter in the Name field.



5. Use the If the pick lists to create criteria for the filter.



The three pick lists and the edit line combine to create a statement that identifies the type of e-mail and where you want the e-mail stored. For example, a filter might read, “If the [Subject] [Contains] sales meeting, Then get mail and move to [Sales].” When you use this filter to sort incoming e-mail, any e-mail containing sales meetings in the subject line is filed in the Sales folder.

To pick list Select the message header field with the information contained in the edit line: To, From, Subject, cc, Date, Size. For example, you might select Date to download only messages that are less than a certain number of days old.

Contains pick list Select a filter action: Contains, Starts with, Does NOT Contain.

Edit line Enter the text that must be found in the header field. For example, if you want to sort e-mail with the subject Sales, enter "Sales." If you enter more than one criteria, separate each with a comma, for example—Sales, New York.

Then get mail and move to pick list Select the folder or mailbox into which you want your filtered e-mail to go. You can also create a new folder for storing the incoming e-mail. Tap Edit Folders, and then create a new folder or delete or rename existing ones.

6. Press Function  + Enter , or tap OK.

The filter appears in the Filters list.



Tap the ▼ icon and then move the filter up or down in the list



Selected filters execute in the order in which they appear on the list. Move filters up and down the list to ensure that they execute in the correct order.

NOTE Filters created on the handheld also apply to e-mail synchronization. See [“Synchronizing an account”](#) earlier in this chapter for more information.

Turning filters on and off

By default, a filter that is turned on or selected affects all subsequent downloads of e-mail until you deselect it. More than one filter can be in effect at once. Before you download e-mail, be sure to turn on the filters you want and turn off those you don't want.

To turn a filter on or off:

1. Press Function  + Menu .
2. Select Options, and then select Filters.

The Filters dialog box appears with the filters you created.

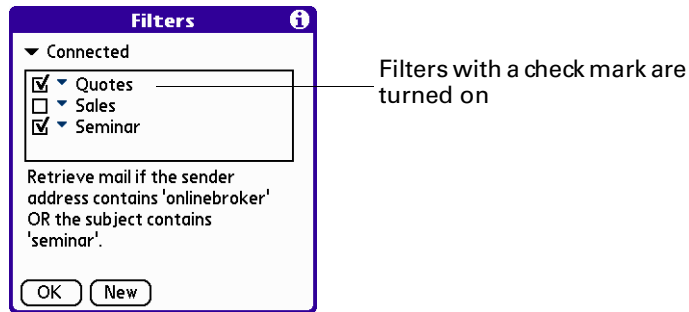

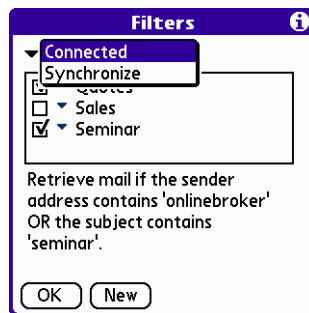

3. Tap the pick list in the upper-left corner, and select Connected or Synchronize.



- Connected applies a filter to a modem transaction.
- Synchronize applies a filter to a HotSync operation.

4. Tap the filter check boxes to select the filters you want to use for subsequent e-mail transactions.



IMPORTANT If you deselect a filter listed under Connected, be sure that the filter is deselected also under Synchronize.



5. Press Function  + Enter , or tap OK.

Editing or deleting a filter

You can edit a filter to change its name or the criteria in the filter.

To edit or delete a filter:



1. Press Function  + Menu .
2. Select Options, and then select Filters.
3. Tap the name of the filter.

4. Do one of the following:
 - To edit the filter, revise your entry in the Name field and/or your selections in the pick lists, and revise the text in the edit line. Tap OK.
 - To delete the filter, tap Delete, and then tap Yes to confirm deletion.
5. Press Function  + Enter , or tap OK.

Managing mail settings

You can configure advanced mail settings such as server information, incoming and outgoing mail server options, and more for each e-mail account.

To select the account whose settings you want to manage:

1. In your Inbox or another folder screen, press Function  + Menu .
2. Select Options.
3. Select Mail Servers.

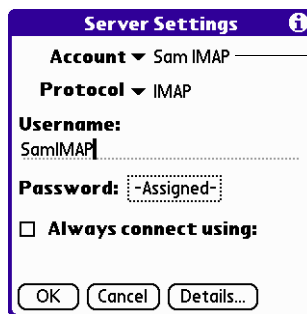

Shows server settings for current account. Tap the Account pick list to edit the account

4. Tap the Account pick list, and then tap Edit Accounts.

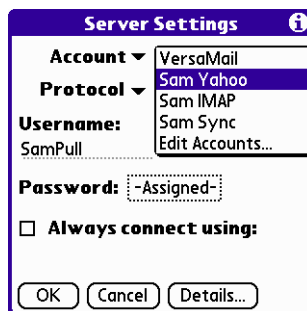



All e-mail accounts appear in the list

5. Tap the name of the account whose settings you want to manage, and then tap OK.

To change the protocol type:

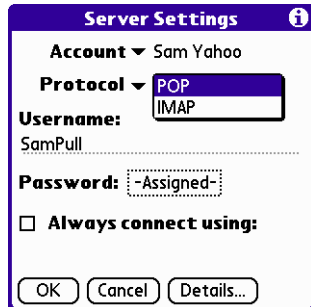
1. In the Server Settings screen, tap the Protocol pick list, and then tap POP or IMAP.





2. Press Function  + Enter , or tap OK.

To change your username or password:

1. In the Server Settings screen, enter a new username.

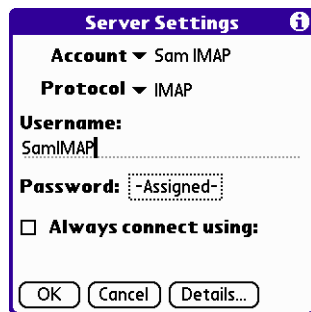
Your username is typically the first part of your e-mail address, which appears before the @ symbol.



2. Tap the Password box, and enter a new password in the Password Entry dialog box.
3. Press Function  + Enter , or tap OK.

To set a default service for this account (different from the default service for your handheld):

1. In the Server Settings screen, tap the Always Connect Using check box.

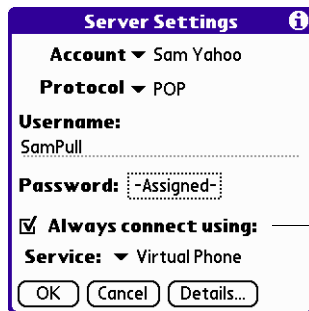

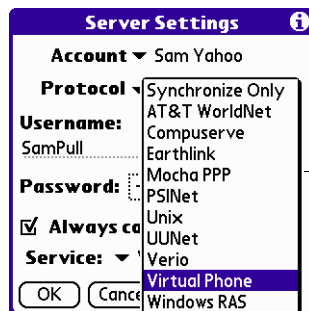

Tap to change the service connection for this e-mail account only from your default handheld service connection

2. Tap the connection type you want from the Services pick list.



Select a service connection for this e-mail account only

3. Press Function  + Enter , or tap OK.

NOTE Select this option only if you want a given e-mail account to use a different service from the default service you set for your handheld. For example, you may have selected a default service that uses the built-in GPRS radio on your handheld to make a network connection. However, for your Earthlink account, you may want to switch to the Earthlink service, which uses dial-up GSM to make a network connection. To do this, tap this check box, then select Earthlink from the Services pick list. Leave this box deselected if you want to use your default handheld service for this e-mail account.

See [Chapter 21](#) for information on setting connection types and selecting a default service for your handheld. See [“Selecting a different service for a given e-mail account”](#) earlier in this chapter for details on using a different service for a specific e-mail account.

To change e-mail address/mail server settings:

1. In the Server Settings screen, tap Details.
2. Tap the Options pick list and select Address/Servers.



3. Edit any of the following:
 - **E-mail address:** Enter the e-mail address of the account you are accessing, such as `examplename@yahoo.com`.
 - **Incoming mail server:** Enter the name of your incoming (POP) mail server, such as `pop.mail.yahoo.com`.
 - **Outgoing mail server:** Enter the name of your outgoing (SMTP) mail server, such as `smtp.mail.yahoo.com`.

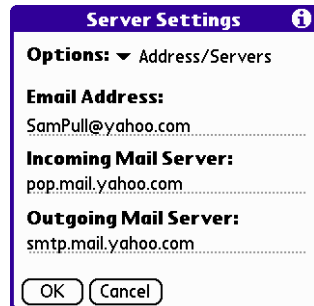

4. Press Function + Enter , or tap OK.

To change incoming mail server settings:

1. In the Server Settings screen, tap Details.
2. Tap the Options pick list and select Incoming Mail.

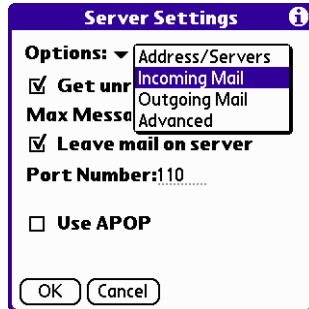

3. The incoming mail options are different depending on the connection type you selected and the server protocol—POP or IMAP.

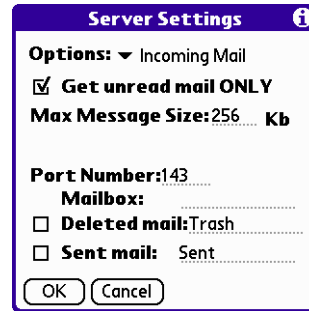
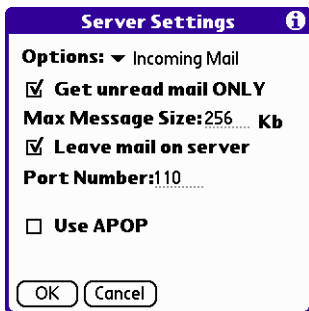

POP accounts

IMAP account



- Leave mail on server (POP only)** Leaves e-mail that you receive on the handheld on the server also.
- Get unread mail ONLY** Retrieves unread e-mail only. To get all e-mail and not just unread e-mail, deselect Get unread mail ONLY.
- Maximum Message Size** Shows the maximum message size that you can receive.
- Use APOP (POP only)** Encrypts your username and password when traveling over the network. Some services require APOP to work properly, while others do not work properly if APOP is used. If you aren't sure if your ISP or web e-mail provider supports APOP, check with your e-mail provider. See [“Adding APOP to an account”](#) later in this chapter.
- Port Number** Defaults to 110 for POP and 143 for IMAP servers respectively. If you are not sure about the correct port number, check with your mail server administrator.

Mailbox (IMAP only)	Defines the root mailbox on your IMAP server.
Deleted Mail (IMAP only)	Stores deleted e-mail in the folder you specify on the server. This field is case sensitive, so spell the folder name exactly as it is on the server. For example, if your Deleted Mail folder is called Trash on the server, you must enter Trash in this space.
Sent Mail (IMAP only)	Shows the name of your Sent Mail folder on the server. This field is case sensitive, and the folder name should be spelled exactly as it is on the server.

4. Press Function  + Enter , or tap OK.

If you are using the Palm VersaMail HotSync Conduit and have an IMAP account, you must configure the outgoing mail settings to send mail.

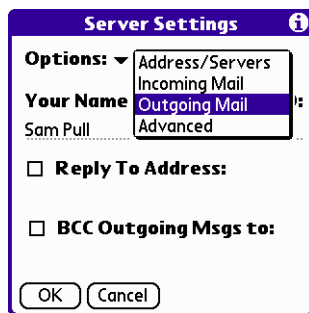

To set outgoing mail server (SMTP) settings:

1. In the Server Settings screen, tap Details.
2. Tap the Options pick list and select Outgoing Mail.

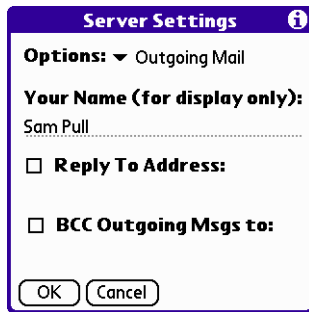

3. Enter any of the following:
 - **Display Name:** Enter the name you want to appear on your outgoing messages, such as “Joe Smith.”
 - **Reply To Address:** Enter the e-mail address that you want recipients to see and reply to on your e-mail messages, only if it is different from the e-mail address from which you are sending the message. For example, if you are sending a message from me@yahoo.com but you want recipients to reply to me@earthlink.net, enter the reply-to address here. Reply To Address makes it look like the e-mail came from the address you entered.
 - **BCC:** Select the BCC check box to send a blind copy of any e-mail message you send to another e-mail address. The blind copy e-mail address is not seen by the other recipients of the message. For example, if you want a copy of all messages you send from your handheld to be sent to your desktop e-mail account, enter that e-mail address.



4. Press Function  + Enter , or tap OK.

To set additional outgoing mail options:

1. In the Server Settings screen, tap Details.
2. Tap the Options pick list and select Advanced Outgoing.

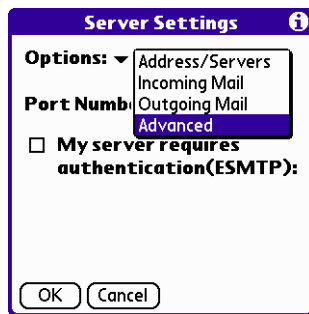

3. Set additional options for outgoing e-mail:

Port Number The default is 25, the port number most SMTP servers use. If you are not sure about the correct port number, check with your mail server administrator.

My server requires authentication (ESMTP) Select this option if the outgoing server (SMTP) requires authentication. Check with your system administrator before selecting this option. See [“Adding ESMTP to an account”](#) later in this chapter.

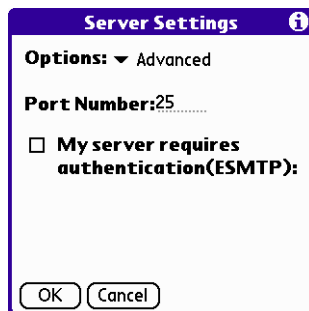



4. Press Function  + Enter  twice, or tap OK twice.

Adding APOP to an account

To encrypt your username and password when traveling over the network, some services require APOP to work properly, while others do not work properly if APOP is used. If you aren't sure if your ISP or web e-mail provider supports APOP, check with your e-mail provider.

NOTE APOP works only with accounts that use the POP protocol.

To edit an account and add APOP:

1. In your Inbox or another folder screen, press Function  + Menu .
2. Select Options.
3. Select Mail Servers.

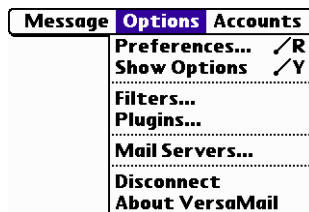

4. Tap the Account pick list and select Edit Accounts.

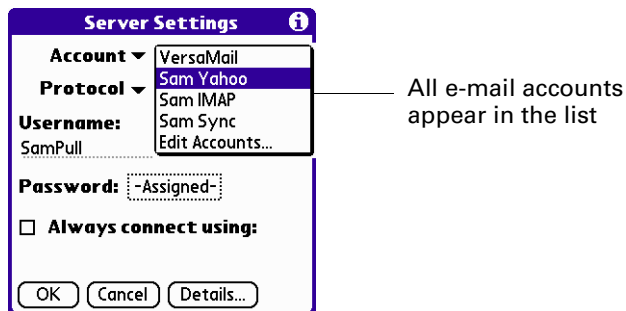



5. Tap the name of the account you want to change, and then tap OK.
6. In the Server Settings screen, tap Details.

7. Tap the Options pick list and select Incoming Mail.

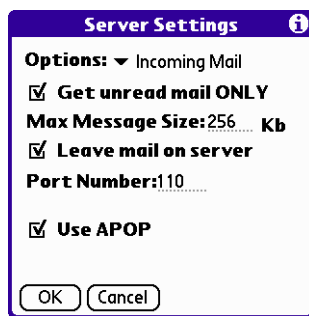

8. Select the Use APOP check box.





9. Press Function  + Enter , or tap OK.

Adding ESMTP to an account

Some services require ESMTP authentication to validate your username and password on a given SMTP server. If you aren't sure if your ISP or web e-mail provider supports ESMTP, check with your e-mail provider.

To edit an account and add ESMTP:

1. In your Inbox or another folder screen, press Function  + Menu .
2. Select Options.
3. Select Mail Servers.

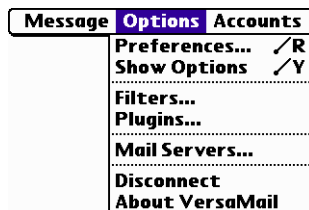

4. Tap the Account pick list and select Edit Accounts.

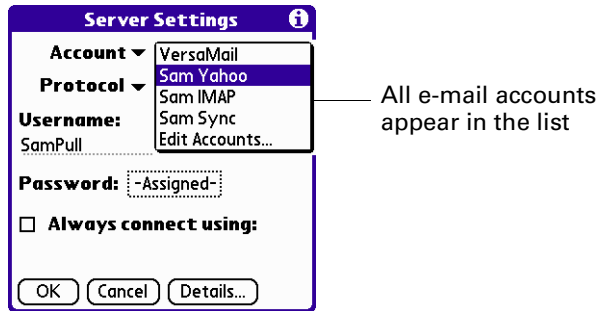

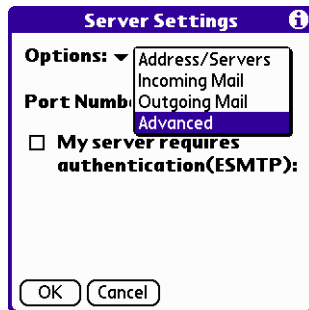

5. Tap the name of the account you want to change, and then tap OK.
6. In the Server Settings screen, tap Details.
7. Tap the Options pick list and select Advanced Outgoing.

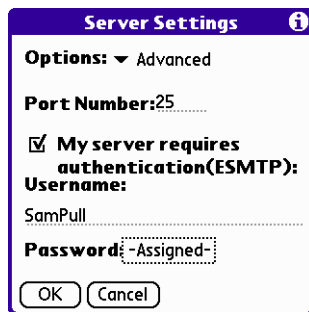

8. Select the My server requires authentication (ESMTP) check box.





9. Press Function  + Enter , or tap OK.



Copying text from an e-mail message for use in other applications

You can copy any text from an e-mail message, either from one you have composed or have read or from an attachment you have downloaded and opened (such as a Word doc), for use elsewhere in the VersaMail application or in another application. Text you can select and copy includes:

- A name
- An e-mail address
- Body text of an e-mail message or a downloaded attachment

To copy and paste text from an e-mail message:

1. Select the text by dragging the stylus over it.
2. Press Command  + C.
3. To paste the text elsewhere in the VersaMail application or in another application, go to the new location and press Command  + V.

TIP You can also tap commands for copying and pasting in the edit menu (press Function  + Menu , and then select Edit) in many handheld applications.

See “Performing common tasks” in [Chapter 4](#) for more information on copying and pasting.



Using the command bar









The command bar provides shortcuts for performing numerous tasks. The options presented on the command bar may change, depending on which screen is displayed in the application. For example, if you are viewing a message in the Inbox, the command bar gives you the option of quickly moving the message to another folder. See “Moving e-mail between folders” earlier in this chapter.

To access the command bar on your Tungsten W handheld:

- Press Command  on the keyboard.

For each type of screen, the command bar offers various options.

View	Options
List (Inbox, Outbox, and so on showing list of messages)	<ul style="list-style-type: none">  Select all messages.  Deselect all messages.  Change display font (toggles between large and small font).  Delete messages from the handheld; icon appears only if you have previously selected all messages.

View	Options
Reading a message	<ul style="list-style-type: none">  Delete message from the handheld.  Move message to a different folder; select folder from pick list.  Change display font (toggles between large and small font).
Composing a message	<ul style="list-style-type: none">  Insert the @ symbol into a recipient's e-mail address.  Add attachment.  Undoes last action; icon appears in command bar only if you have previously performed one of the actions above or any of the cut/copy/paste functions described below.
Reading or composing a message	<ul style="list-style-type: none">  Cuts selected text.  Copies selected text.  Pastes selected text.

See “Using menu commands” in [Chapter 3](#) for more information on the command bar.

E-mail header details

When viewing a message in any folder, you can change the view of the message header. The e-mail header options are as follows:

- **Short header:** Shows sender's name or address (From field) and subject line (Subj field).

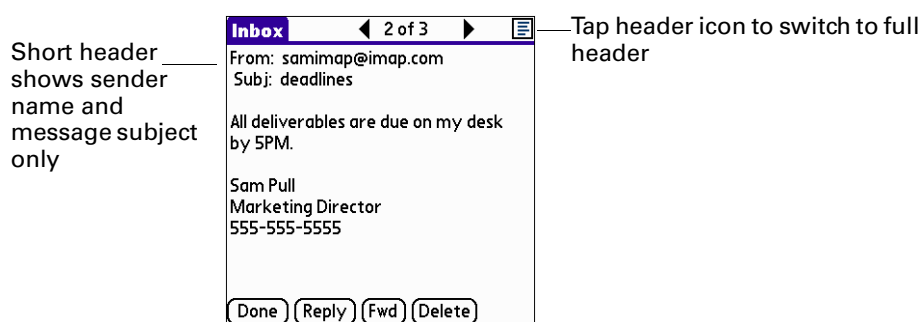

- **Full header:** Shows the following:
 - Sender's name or e-mail address (From field)
 - Subject line (Subj field)
 - Date message was composed, sent, or received (Date field)

- Size of message including any attachments (Size field)
- Recipient's name or e-mail address (To field)

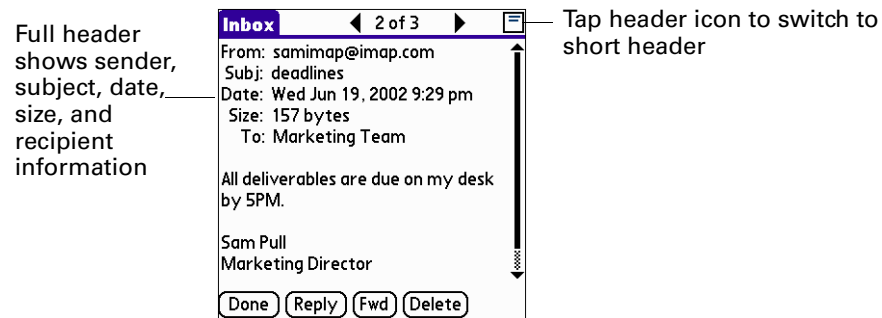



To switch between short header and full header view, tap the header icon in the upper-right corner of the message screen.

Backing up mail databases

In most cases your e-mail is on your server, so you do not need to back up your e-mail database from your handheld. If you want to make sure you have a current copy of all your e-mail, you can back up all the e-mail databases from the handheld.

To back up the e-mail database:

1. Press Command  + R.

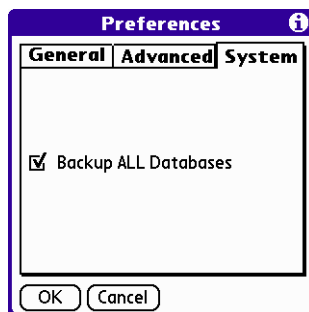

Alternately, press Function  + Menu , select Options, and then select Preferences.

2. Tap System.



3. Tap Backup ALL Databases to select it.

NOTE If you don't select this option, HotSync operations are faster.

4. Press Function  + Enter , or tap OK.

Wireless IMAP folder synchronization

If you create an IMAP folder in an account on your handheld that matches a folder on the mail server, you can wirelessly synchronize e-mail messages that you move into or out of the IMAP folder, or delete in the folder.

When you synchronize a folder, any e-mail messages in the selected folder on the mail server will be downloaded to the same folder on your handheld. Any messages moved out of the selected folder on your handheld or deleted on your handheld will be moved or deleted in the folder on the mail server.

Depending on how you have set up IMAP folders on your handheld and/or the mail server, you may have to perform some steps before you can wirelessly synchronize e-mail messages between your handheld and the server, as follows:

- If you need to create a folder on both your handheld and the server, see [“Creating and editing mail folders”](#) earlier in this chapter. Be sure to select the Also create on server check box as described in that section. After creating the folders, continue with the following procedures for synchronizing IMAP folders.
- If there is a folder on the mail server but need to create it on your handheld. see [“Creating and editing mail folders”](#) earlier in this chapter. You do not need to select the Also create on server check box as described in that section. After creating the folder, continue with the following procedures for synchronizing IMAP folders below.
- If you have a folder on your handheld that matches a folder on the mail server, continue with the following procedures for synchronizing IMAP folders.



You can synchronize either a single pair of handheld/mail server folders, or multiple pairs of folders.

NOTE You can synchronize folders whose names are up to 16 characters in length. You can synchronize up to 11 custom folders you create, in addition to the default folders Inbox, Outbox, Drafts, Sent, and Trash.

To wirelessly synchronize a single pair of handheld/mail server IMAP folders:

1. From within an IMAP e-mail account, tap the folders pick list in the upper-right corner of the screen and select the folder you want to synchronize.
2. Tap Get Mail.

To synchronize multiple pairs of IMAP folders:

1. In your Inbox or another folder screen of an IMAP e-mail account, press Function  + Menu .
2. Select Options.

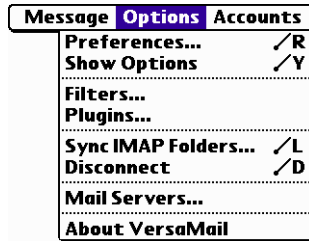

3. Press Command  + L (alternately, select Sync IMAP Folders).
4. Select the folders you want to synchronize from the pick list. A connection is made to your network provider to update the server with changes from your handheld, and to have your handheld updated with changes from the server.

Accessing corporate e-mail

Many corporate e-mail servers—including Microsoft Exchange and Lotus Domino servers—support direct IMAP access. If you are accessing your e-mail using the VersaMail application and an 802.11 network behind your company's firewall, you may be able to directly access your business e-mail. If your company requires extra security or you are accessing your e-mail through either a dial-up connection or a LAN outside of your company's firewall, you will need to use a Virtual Private Network (VPN) client before you can access your business e-mail. Check with your company's network administrator for information about VPN access, your business e-mail username and password, and IMAP and SMTP settings.

Five-way navigation in the VersaMail application

The following table summarizes the controls for the five-way navigator on your handheld that are specific to the VersaMail application. See [“Using the navigator”](#) in [Chapter 3](#) for general navigator information.

View	Selection	Navigation	Function
Main List (Inbox or other folder list)	No message selected	Up/Down	Scrolls between messages in list.
		Select	Highlights the first message in the list.
		Right	No function.

View	Selection	Navigation	Function
		Left	No function.
	Message selected	Select	Opens messages for viewing.
		Right	Displays context menu that normally appears when clicking on the e-mail icon for each message.
		Left	Returns you to the “no message selected” options.
Compose New Message	N/A	Up/Down	In To, cc, bcc, and Subject fields: Tabs to the next/previous field. In message body text: Scrolls the text viewed on the text list.
		Select	No function.
		Right	In To, cc, bcc, and Subject fields: Moves to the next character. In message body text: No function.
		Left	In To, cc, bcc, and Subject fields: Moves to previous character. In message body text: No function.
Read Message	N/A	Up/Down	Scrolls the message text.
		Select	Returns you to list view.
		Right	Displays the next message. If you are is viewing the last message, returns you to the folder list view.
		Left	Displays the previous message. If you are viewing the first message in the folder, returns you to the folder list view.

When you return from viewing a message to the list view (Inbox or other folder), the message you were viewing may or may not be selected in the list, according on the following:

- If you pressed Select to view the message, the message will be highlighted on the list on when you return to the list view
- If you used the stylus or pressed Right or Left to view the message, the message will not be highlighted when you return to the list view. If you press Select, the first message in the list will be selected.

The following sample procedure shows how to use the navigator to read and delete a message.

To read and delete a message:

1. Press Up or Down on the navigator to scroll to the message you want to read.
2. Press Select to select the message, and then press Select again to open the message.
3. After reading the message, press Select to close the message.
4. (Optional) The cursor should remain on the selected message. If not, press Up or Down to scroll to the message, and press Select to select the message.
5. Press Right to open the pop-up menu.
6. Press Down to scroll to Delete Message.
7. Press Select to delete the message.
8. Press Select to confirm that you want to delete the message.

Keyboard shortcuts in the VersaMail application

The following tables summarizes the keyboard shortcuts specific to the VersaMail application. See [“Using ShortCuts”](#) in [Chapter 3](#) for general keyboard shortcut information.

To use a keyboard shortcut:

1. Press Command .
2. Press the letter of the shortcut.

ShortCut	Feature
A	Add Attachment
C	Copy
D	Delete
E	Empty Trash
F	Forward Message
H	Mark Read
I	Mark Unread
K	Keyboard
L	Address Lookup
M	Get Message

ShortCut	Feature
N	Create New Message
O	Reply to Message
P	Paste
Q	Go to Bottom
R	Preferences ...
S	Select All
T	Go to Top
U	Undo
V	Move To ...
W	Save to Draft
X	Cut
Y	Send
Z	Deselect All
Press & hold Mail	Get & Send

Using Palm™ WAP Browser



Palm™ WAP Browser enables you to quickly and easily browse the Internet by using specially formatted WAP (Wireless Application Protocol) sites.

Use Palm WAP Browser to do the following:



- Access specially formatted WAP (Wireless Application Protocol) sites.
- Sign up with a provider to receive Push messages automatically to inform you of important events, such as changes in stock prices.
- Bookmark special WAP sites so that you can easily return to them.
- Make confidential transactions using encrypted keys.
- Store and manage certificates.

IMPORTANT Whenever you use the wireless features of your handheld, please observe the guidelines or prohibitions on the use of wireless devices in your current location. For example, when you are on an airplane, do not turn on your radio at times when government or airline regulations prohibit the use of cellular phones. You can, of course, use all other applications of your handheld in accordance with airline regulations for electronic devices.

Opening Palm WAP Browser

Some wireless service providers have set the Wireless button  to open Palm WAP Browser rather than Palm Web Browser. If your handheld is set to open Palm WAP Browser from the Wireless button, Palm WAP Browser opens the wireless service provider's launch page.

To open Palm WAP Browser from the Applications Launcher:

1. Press Home .
2. Tap the WAP icon .

A Welcome screen appears, indicating that you have successfully opened Palm WAP Browser.

NOTE The appearance of the Welcome screen may differ depending on the wireless service provider you are using.



Opening a WAP site





Palm WAP Browser allows you to open WAP sites on the Internet. WAP sites are formatted using WML (Wireless Markup Language). These WAP site addresses (URLs) usually begin with wap—for example, wap.palm.com. Some WML sites also use www.

NOTE Palm WAP Browser does not open the same web sites as a standard web browser. Standard web sites are formatted using HTML (Hypertext Markup Language), and the URLs usually begin with www—for example, www.palm.com.

To open a WAP site, do one of the following:

- Enter a URL.
- Select a URL from the history list.
- Select a bookmark (see “Using bookmarks” later in this chapter).

To open a WAP site by entering a URL:

1. Open the Open URL dialog box by doing one of the following:
 - Tap the Globe icon  in the upper-right corner.
 - Press Command Stroke  + O.
 - Press Function  + Menu , and then select Open URL on the Go menu.
2. Enter the URL.

Enter characters using the keyboard, or by tapping an item to insert common URL elements.

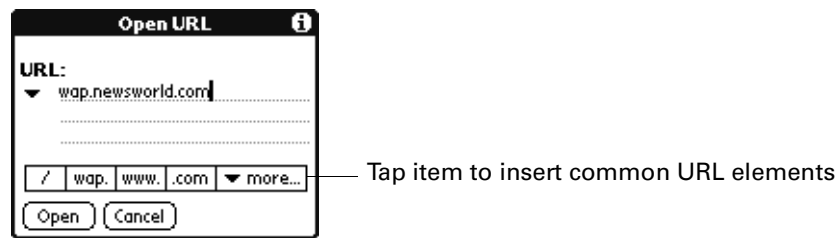

3. Tap Open.

To open a WAP site from the history list:

1. Tap the Globe icon .
2. Tap the pick list arrow.

The most recently visited WAP site URLs are listed.

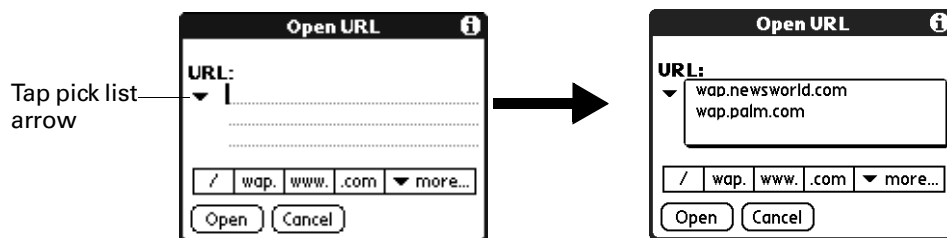

3. Select a URL from the history pick list and tap Open.

Browsing a WAP site

Browsing a WAP site using Palm WAP Browser is similar to using a standard Internet browser. The browsing area displays the WAP site with text and underlined hyperlinks that can be accessed by tapping the link. The title bar displays information such as the name of the WAP site and navigation icons.

When a WAP page is being downloaded, the title bar displays the following:

- Status

Connecting: Indicates the handheld is connecting to the WAP gateway.

Sending: Indicates the Palm WAP Browser is sending a request to a WAP site to download a page.

Receiving: Indicates the Palm WAP Browser is receiving content from the WAP gateway.

- **Stop icon:** Tapping the Stop icon halts the download, and only areas of the page that were downloaded are displayed.

- **Signal strength indicator:** Shows the signal strength of the connection. If the signal strength indicator shows only one or two bars, the download could take longer or fail. Move to an area where you have a strong signal.

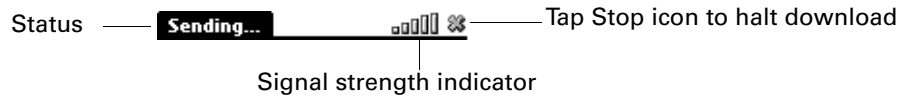

When the WAP site is fully downloaded on the handheld, the title bar changes to display the name of the WAP site and the following navigation icons:

- **Back:** Returns to the previous page.
- **Reload:** Downloads current page from the source. If you are using cache memory, the current page that is saved in cache memory is *not* used.
- **Open URL, Bookmarks, and Home:** Provide the same function as on the Welcome screen (see [“Opening Palm WAP Browser”](#) earlier in this chapter).



Browsing secure WAP sites

When you access certain secure WAP sites, such as a bank, you are temporarily transferred to a secure gateway. Whenever you are transferred to a secure gateway, you are informed of the change and asked for permission.

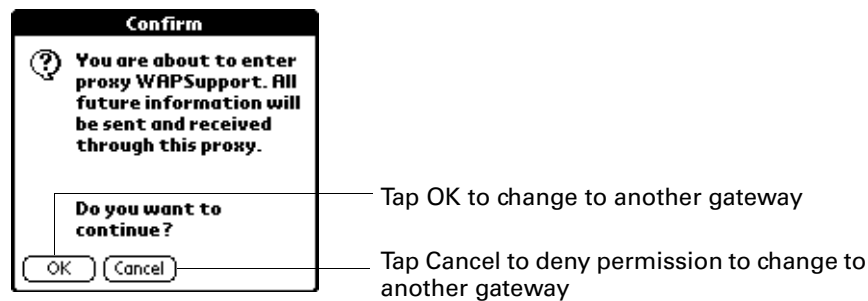

Once you have finished with the secure site, the Palm WAP Browser will automatically change back to the default WAP gateway.

If the Palm WAP Browser is connected to a gateway using the optional security layer WTLS, a small padlock is displayed in the title area. Tapping the Padlock icon opens the Connection Information dialog box describing the WAP gateway address and WAP stack configuration.

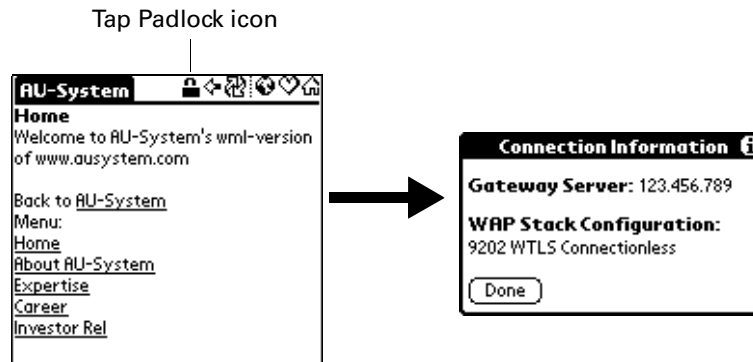

If you have a secure connection using a WAP gateway server certificate, tapping the View certificate button displays certificate information.

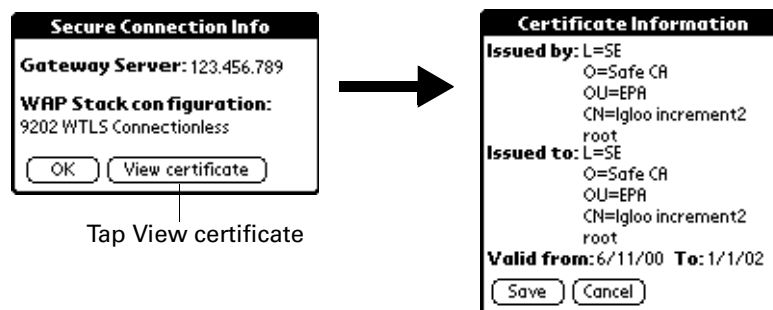

Using bookmarks

Bookmarks allow you to manage a list of your favorite WAP sites. You can easily access your bookmarks by tapping the Bookmark icon in the title bar.

Adding a bookmark

You can add a WAP site to the Bookmarks list in two ways:

- Add the current WAP page using the Go menu.
- Enter the information in the Edit Bookmarks dialog box.

To bookmark the current WAP page:

1. Open the WAP site.
2. Press Command Stroke (✓) + B.

Alternately, press Function (○) + Menu (✓), and then select Add to Bookmarks on the Go Menu.

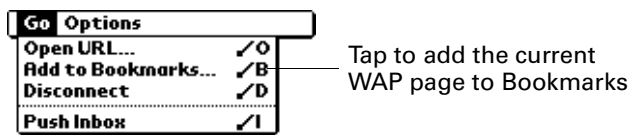

To enter a bookmark from the Edit Bookmarks dialog box:

1. Tap the Bookmark icon (♥).
2. Tap Edit Bookmarks.

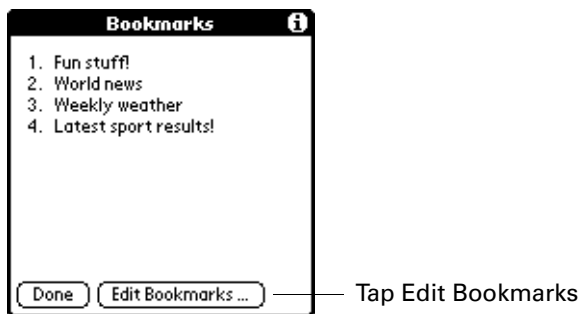

3. Tap New.



4. Enter the bookmark name and URL, and then tap Done.

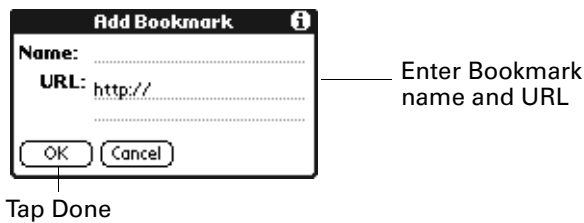

Visiting a bookmarked WAP site

By tapping a bookmark on the Bookmarks list, you can quickly open the WAP site.

To open a WAP site from the Bookmarks dialog box:

1. Tap the Bookmark icon ♥.
2. Tap a bookmark to begin downloading the WAP page.

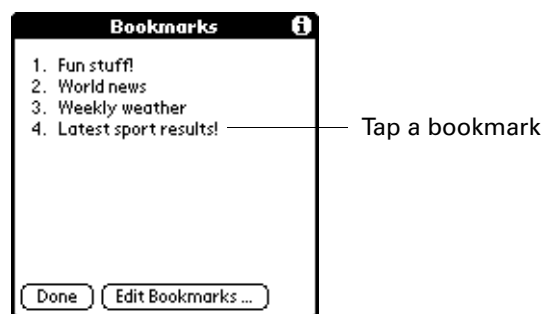

Editing a bookmark

You can edit an existing bookmark using the Edit Bookmarks dialog box.

To edit a bookmark:

1. Tap the Bookmark icon ♥.
2. Tap Edit Bookmarks.

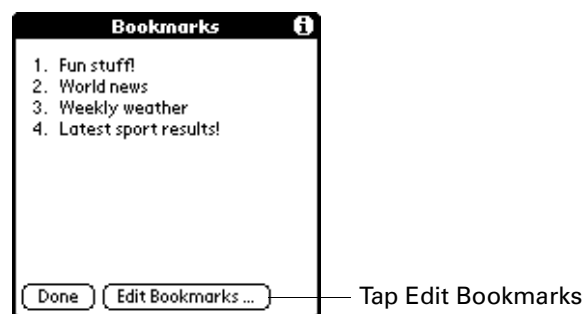

3. Select a bookmark, and then tap Edit.



Tap Edit

4. Edit the bookmark name and URL, and then tap OK.



Edit the bookmark name and URL

Tap OK

Deleting a bookmark

You can delete sites from your bookmarks list using the Edit Bookmarks dialog box.

To delete a bookmark:

1. Tap the Bookmark icon .
2. Tap Edit Bookmarks.
3. Tap the bookmark you want to delete.



Tap bookmark

Tap Delete

4. Tap Delete.
5. In the Confirmation dialog box, tap OK.

Using your Push Inbox

The Push Inbox lists all WAP Push messages received or stored by the handheld. Push messages are sent from services that you sign up for—for example, notifications of new e-mails, changes in stock prices, and so on. The service must support WAP Push.

You can open the Push Inbox in the following two ways:

- Tap Push Inbox from the Go menu.

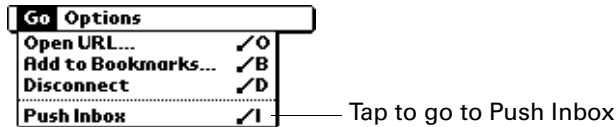

- Tap the new message line on the Welcome screen.

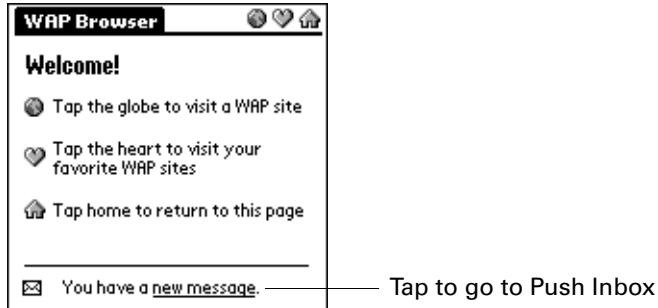

Unread messages are displayed in bold font.

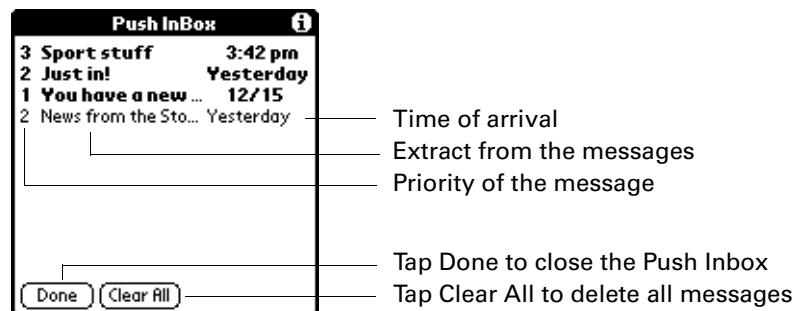

The Push Inbox list has the following three columns:

- Priority of the message
 - 1 - High
 - 2 - Medium
 - 3 - Low
- Extract from the message

- **Time of arrival:** The time of arrival is set differently depending on when the message was received. If it was received today, the time of arrival is shown. If received yesterday, the text Yesterday is displayed. If received earlier than yesterday, the date of arrival is displayed.

Tapping a message opens the Push Message dialog box, showing all available information about the message. This dialog box displays the following:

- **From:** Where the message came from
- **Received:** Date and time the message was received
- **URL:** The URL associated with the message
- **Message:** The content of the message

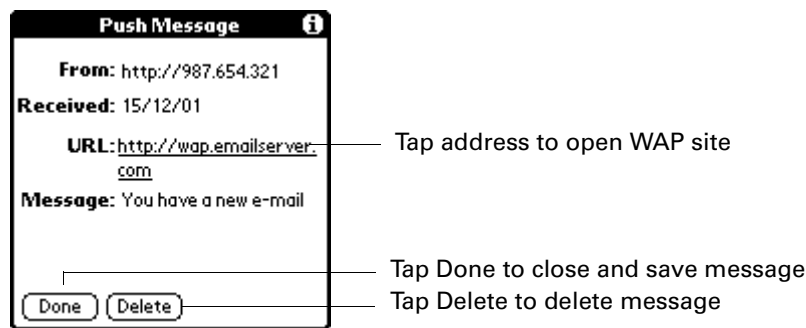

Using advanced features

Palm WAP Browser has many advanced features that allow you to modify performance and set security features. These options affect the performance of your browser and should be set by knowledgeable users. You may want to consult with technical support from your wireless service provider before changing some of these options.

Changing gateways

When you connect to the Internet, you normally connect through the default WAP gateway. Gateways are servers used to access WAP sites.

NOTE Generally, the gateway is automatically set by your wireless service provider and it may be hidden or locked. Changing this setting can disable your Palm WAP Browser's ability to access sites, so please exercise caution if you alter this setting.

You can check or change the gateway settings from the Gateway dialog box. To access the Gateway dialog box, tap Gateway Settings on the Options menu.

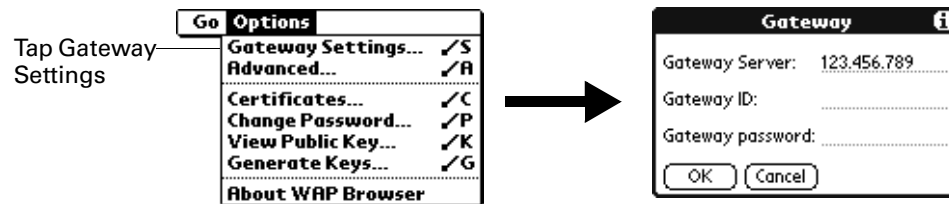

Setting advanced options

The Advanced dialog box allows you to enable or disable the cache functions, select an access point name, and select a mode.

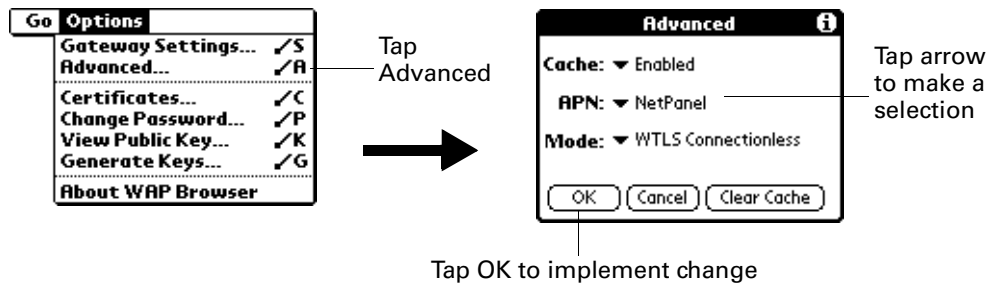

Using cache memory

The Cache pick list on the Advanced dialog box allows you to enable or disable the cache memory. The default setting is cache memory enabled. Cache memory stores and displays a previously loaded WAP page rather than reloading the page each time. This enables you to save time in viewing pages, but you might view an older saved page rather than an updated one.

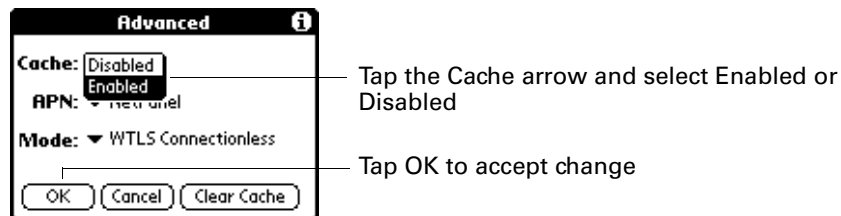

When viewing a page, you can update the current page by tapping the Reload icon. A new page is downloaded from the WAP site.

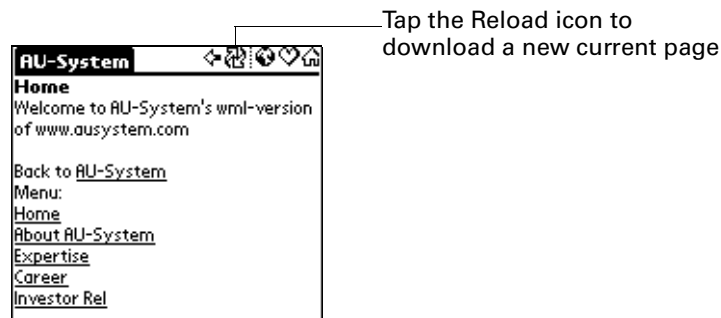

You can also clear cache memory so that all stored pages are deleted by tapping the Clear Cache button on the Advanced dialog box.

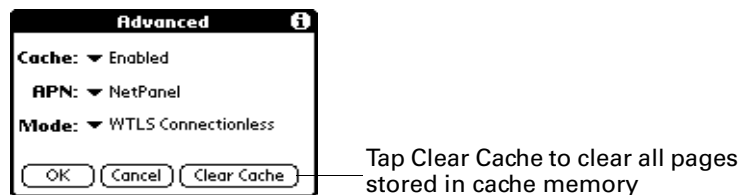

Selecting an Access Point Name

The APN pick list on the Advanced dialog box allows you to select an Access Point Name (APN) from a preset number of alternatives. The selections available in the APN list are dependent on your wireless service provider. The APN may be preset or configured automatically by your wireless service provider.

NOTE Changing the APN can disrupt your access to the Internet. Contact your wireless service provider for more information.

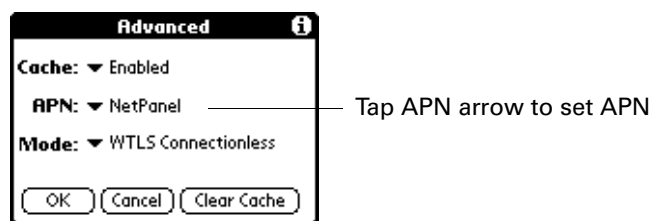

Selecting Mode

NOTE Changing the mode can disrupt your access to the Internet. The mode should not be changed unless you receive specific instructions from your wireless service provider.

The Mode pick list on the Advanced dialog box allows you to set the WAP stack configuration. There are two standard modes and two secure modes:

Standard modes

- Connectionless (CL-WSP: Connectionless - Wireless Session Protocol)
- Connection Oriented (CO-WSP: Connection Oriented - Wireless Session Protocol)

Secure modes

- WTLS Connectionless (CL-WTLS-WSP: Connectionless - Wireless Transport Layer Security - Wireless Session Protocol)
- WTLS Conn. Oriented (CO-WTLS-WSP: Connection Oriented - Wireless Transport Layer Security - Wireless Session Protocol)

Each mode has a port number associated with it:

- Connectionless - 9200
- Connection Oriented - 9201
- WTLS Connectionless - 9202
- WTLS Conn. Oriented - 9203

Once the WAP stack configuration for a WAP gateway is set, this parameter should not be changed unless you want to use another WAP gateway (see [“Using the security features”](#) earlier in this chapter).

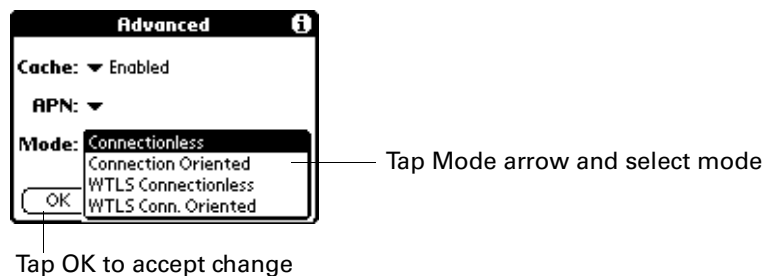

Using the security features

The Palm WAP Browser uses the Public Key Infrastructure (PKI) method to exchange secure messages between you and another party. PKI is based on the use of a password key pair and a signature key pair. Each key pair has one public key and one signed key. The public key can be available to anyone, but you must store the signed key securely. All security of a PKI solution is based on the integrity of the signed key.

The public key is exchanged between you and another party using a certificate created and signed by a trusted Certificate Authority (CA). (The process of creating certificates and using a CA is beyond the scope of this chapter.) You can use the same key pair for several certificates.

All certificates are stored in the WAP Identity Module (WIM). The WIM is a storage area designed to store certificates, your private keys, and secure session data used to establish a secure connection. Usually the WIM is a smart card. Palm WAP Browser uses a software WIM that has the same functionality.

Palm WAP Browser uses the following two protective passwords:

- **Password:** Protects the password key pair. This password also protects the WIM and must be entered every time you access any content in the WIM.
- **Signature:** Protects the signature key pair. This signature is used only when you are asked to verify that you accept something asked for by another, such as a bank transfer.

Palm WAP Browser allows you to create multiple password and signature key pairs. Each type of key pair is protected by a password or signature that you create. You have only one password and one signature even if you have multiple key pairs. You can change the password and signature at any time.

Creating password and signature key pairs

To protect your transactions, you need to create a password key pair. If you are signing documents, you will also need to create a signature key pair.

IMPORTANT Key generation can take up to an hour. During this time, your handheld appears to be completely frozen and you are not able to use your handheld.

You can create a password and signature key pair by opening the Generate Keys dialog box from the Options menu. You select which kind of key pair you want to generate: password or signature.

If this is the first time that you have generated the selected type of key pair, you must enter a password or signature to protect access to and usage of the keys. If you have already generated this type of key pair, you must enter the corresponding password or signature to continue the key generation.

To create a password key pair:

1. Press Command Stroke (⌘) + G.

Alternately, press Function (F) + Menu (⌘), and then select Generate Keys on the Options menu.

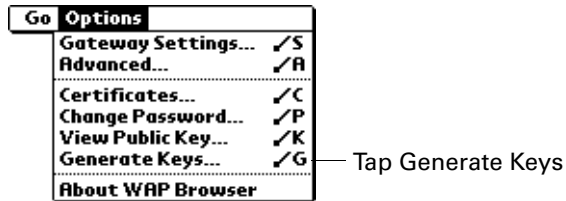

2. Tap Continue.



3. Tap Password key pair.

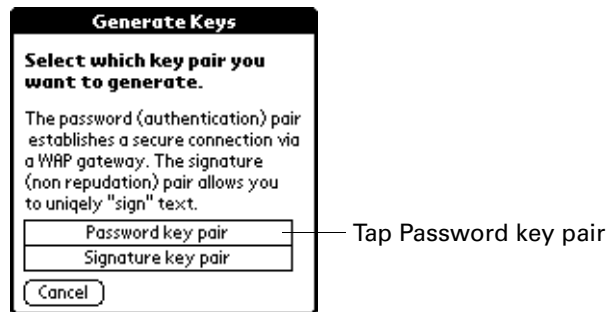

4. Enter your password twice and tap OK.

If you have already created a password key pair, enter the password you have already created. You can use any characters to set the password or signature—for example, small and capital letters, numbers, or symbols.

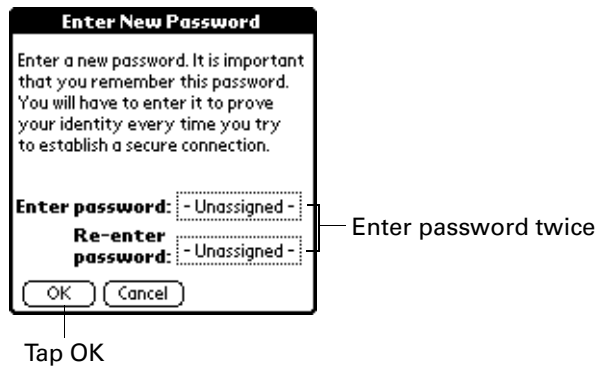

A Generating Key Pair dialog box appears, informing you that it may take an hour to generate the key pair. When the key pair has been generated, a confirmation dialog box appears.

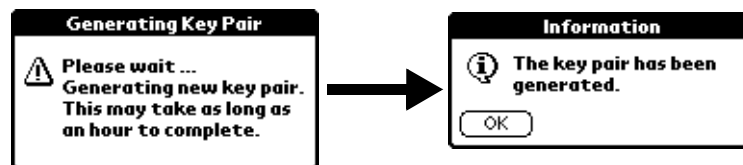

5. Tap OK.

NOTE Generating a password key pair and generating a signature key pair are similar. To generate a signature key pair, follow the steps for creating a password key pair, and select Signature key pair in step 4.

Changing your password or signature

Maintaining a secure password and signature is critical for the security of your transactions. You can change your password or signature regularly to maintain security.

To change your password:

1. Press Command Stroke (⌘) + P.

Alternately, press Function (Fn) + Menu (⌘), and then select Change Password on the Options menu.

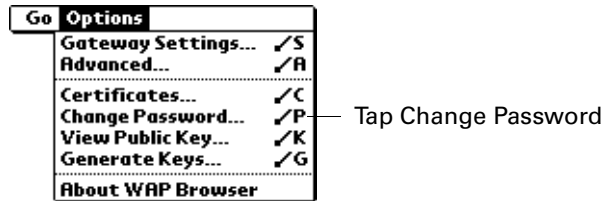

2. Tap Personal password.

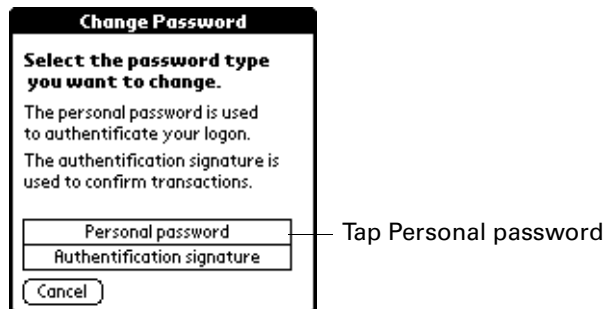

3. Enter your current password, and then tap OK.

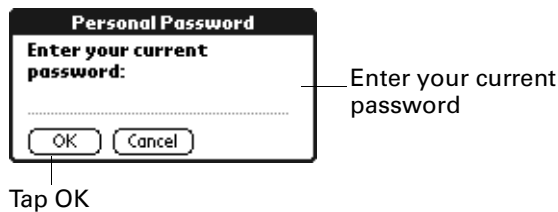

4. Enter the new password, and then tap OK.

You can use any characters to set the password or signature—for example, small and capital letters, numbers, or symbols.

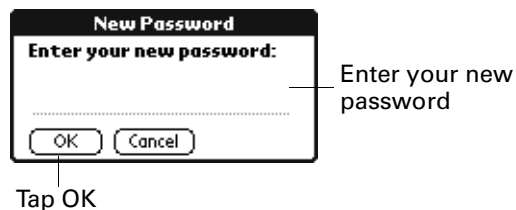

- Verify the new password by entering the password again, and then tap OK.

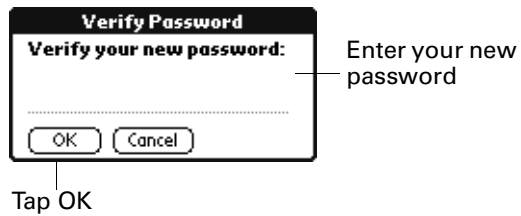

- In the Information dialog box, tap OK.

NOTE Changing a password and changing a signature are similar. To change your signature, follow the steps for changing your password, and select Authentication signature in step 3.

Viewing the public key and the signed key

Once you create a keyed pair, you can view the public key and signed the key by opening the View Public Key dialog box from the Options menu. This information is useful if you need to send a copy of the public key to your CA. The displayed keys are Base64 coded.

To view your public key and signed key:

- Press Command Stroke (⌘) + K.

Alternately, press Function (F) + Menu (⌘), and then select View Public Key on the Options menu.

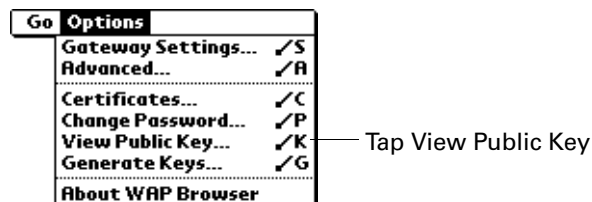

- Tap Password key pair.

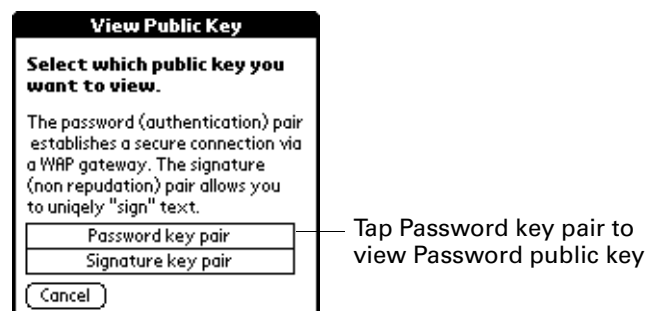

- If you have several key pairs, a list of certificates is displayed and you can tap the appropriate certificate.

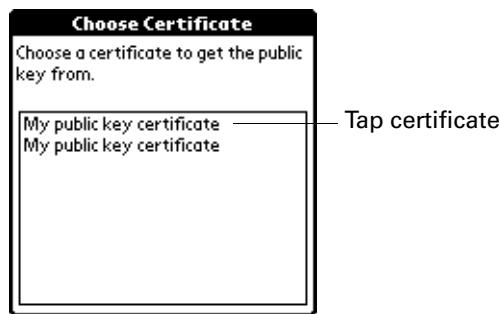

- Tap View Signed Key to view the signed public key.

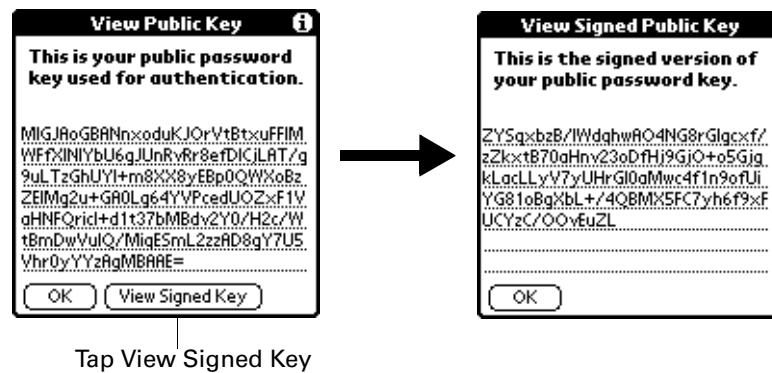

- Tap OK.

NOTE Viewing a password and changing a signature key pair are similar. To view your signature public key, follow the steps for viewing your password public key, and select Signature key pair in step 2.

Storing certificates

Palm WAP Browser supports both CA or root certificates and user/server certificates. Certificates are stored securely in the WIM, where you can view or delete them.

You can download a certificate from a WAP page by tapping the link to the certificate. Once the CA has approved your request for a certificate, the certificate is available for downloading.

To store a certificate:

1. Tap the certificate download link.

The certificate download link varies depending on the WAP site.

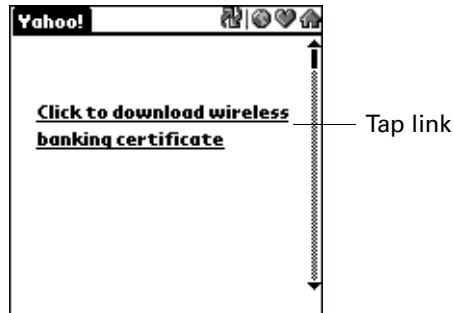

2. Tap Save.



3. Enter your password and tap OK.

Your password is the same password that was set when you generated your Password key pair.

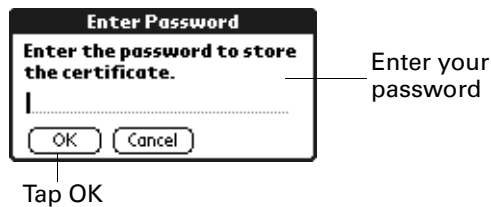

4. If you are storing a user certificate, you can enter a friendly name and tap OK.

The name is used for the certificate list when you are viewing your certificates. Make the name clear so that you can recognize the certificate. The friendly name is optional.

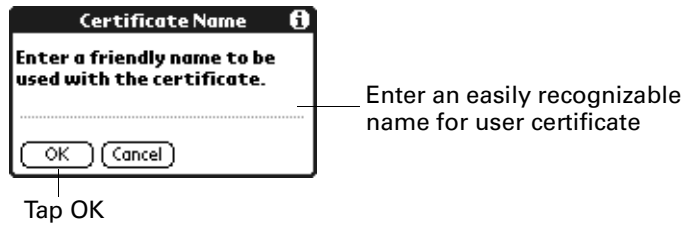

5. Tap OK.

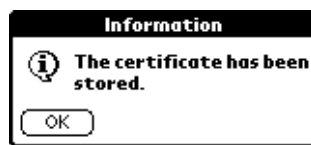

Viewing certificates

You can view your stored certificates by opening the Certificates dialog box from the Options menu.

To view your stored certificates:

1. Press Command Stroke (⌘) + C.

Alternately, press Function (Fn) + Menu (⌘), and then select Certificates on the Options menu.

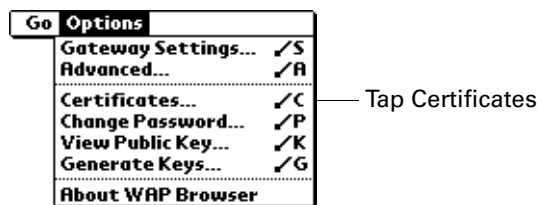

2. Tap the certificate name.

You can delete the certificate by tapping Delete.

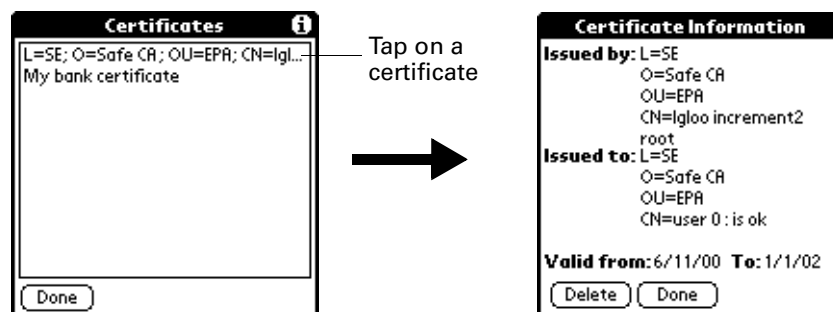

Using Palm WAP Browser menus

Palm WAP Browser menus are shown here for your reference, and the Palm WAP Browser features that is not explained elsewhere in this book is described here.

See “Using menus” in [Chapter 4](#) for information about choosing menu commands.

Go menu

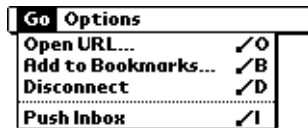

Options menu



About WAP Browser

Shows version information for Palm WAP Browser.

Using World Clock

 World Clock enables you to view the current time and date in multiple locations and to set an alarm. Use World Clock to do the following:

- View the current time and date in three locations.
- Open a preferences screen where you can set the time and date for all the applications on your handheld.
- Set an alarm.
- Set Daylight Saving options.

To open World Clock and view the time:

1. Press Home .
2. Select the World Clock icon .

TIP Select on the navigator, and then tap Go to Clock.



Setting the primary location

You can use World Clock to select the Location and Date & Time for the primary location. Keep in mind that the primary Location settings are system date and time and that these settings are used by all the applications on your handheld. The primary Location settings also appear in the Date & Time Preferences screen. Similarly, if you change the settings in the Date & Time Preferences screen, those settings become your system date and time and also appear under the primary Location in World Clock. The primary Location settings also serve as a point of reference for the secondary locations.

The following procedures show you how to set the Location and Date & Time from within World Clock. See [“Date and Time preferences”](#) in [Chapter 21](#) for details on setting these preferences.

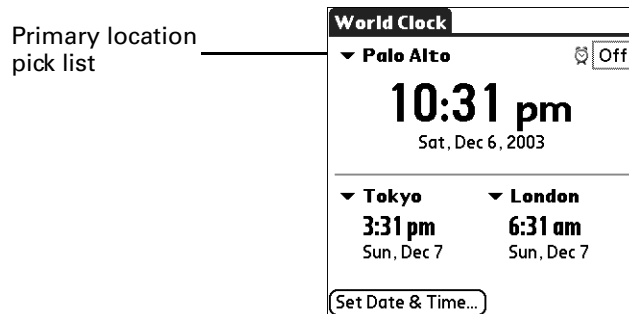

To set the Location:

1. Tap the primary location pick list.



2. Tap the location you want to use as the primary location.



The location you select is typically a large city in the same time zone as the one where you live. If an appropriate choice does not appear in the list, see [“Adding a location”](#) later in this chapter to create a new location.

3. Press Function  + Enter , or tap OK.

To set the date:

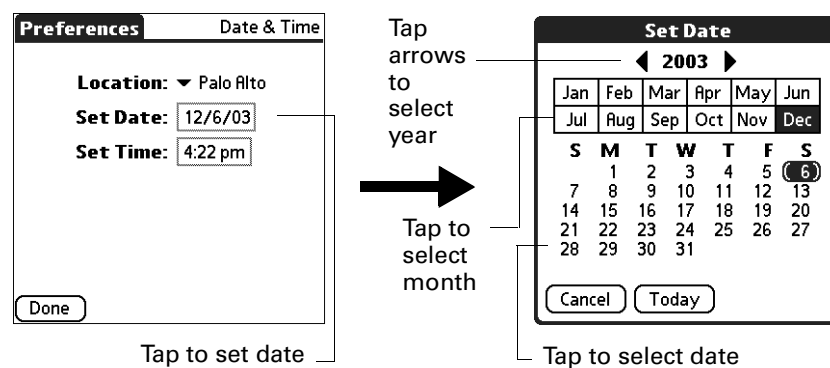
1. Tap Set Date & Time.
2. Tap the Set Date box.
3. Tap the arrows or press Right and Left on the navigator to select the current year.





4. Tap the current month.
5. Tap the current date.
6. Press Function  + Enter , or tap Done.

To set the time:

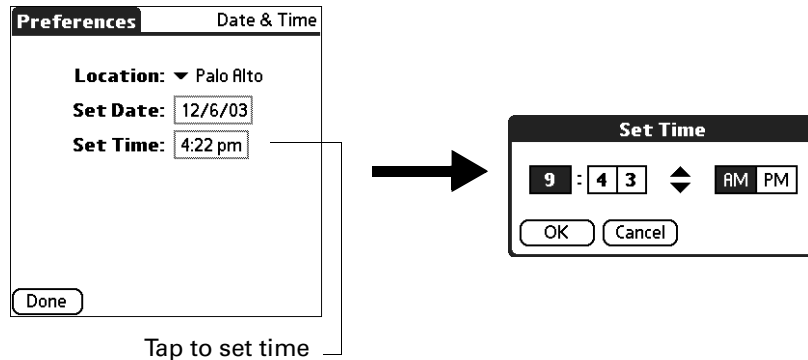
1. Tap Set Date & Time.
2. Tap the Set Time box.



3. Tap the up or down arrows to change the hour.
4. Tap each number of the minute, and then tap the arrows to change them.
5. Press Function + Enter , or tap OK.
6. Press Function + Enter , or tap Done.

Choosing a different primary location

If you travel to another location and you want alerts to appear based on local time, you need to change the primary location to update the system time. You may, however, prefer to use the secondary locations to view the local date and time, and leave the primary location set to your home location.

To change the primary location:

1. Tap the pick list next to the current primary location.

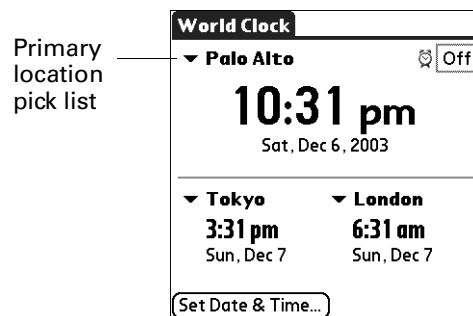

2. Select the location you want to use as the new primary location.

If the new location is in another time zone, World Clock automatically updates the date and time in all the applications on your handheld.

Setting the secondary locations

The secondary locations display the date and time in two locations other than the primary location. You can use the secondary locations to view the time in places to which you travel or you need to contact people.

The date and time in the secondary locations are based on the Date & Time in the primary location.

To select the secondary Locations:

1. Tap the pick list next to the secondary location.

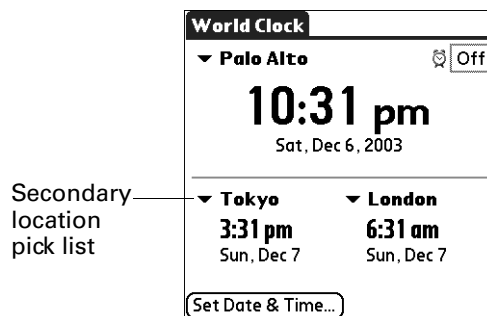



2. Select the location you want to use as the new secondary location.

If an appropriate location does not appear in the list, see the next section [“Adding a location”](#) to create a new location.

Adding a location

If an appropriate location does not appear in the Location pick list, you can add a new location to the list, and if necessary adjust the time zone and Daylight Saving settings. If you activate the Daylight Saving options, the time change automatically occurs at 1:00 AM on the selected start and end dates.

To add a location:

1. Tap the Location pick list.
2. Select Edit List.
3. Tap Add.
4. Select a location that is in the same time zone as the city you want to add.
5. Press Function  + Enter , or tap OK.
6. (Optional) Tap the Name field and modify the Location name.

- (Optional) Tap the Time Zone box and select a time zone.

- Press Function + Enter , or tap OK.
- Press Function + Enter , or tap Done.

To set Daylight Saving options:





- From the Edit Location dialog box, tap the This location observes Daylight Saving Time check box to select it.
- Tap the Start box.

- Tap the month when daylight saving begins.
- Tap the Week pick list.
- Select the week when daylight saving begins within the selected month.
- Tap the Day pick list.
- Select the day of the week when daylight saving begins within the selected week.
- Press Function + Enter , or tap OK.
- Tap the End box and repeat steps 3 through 8 to select when daylight saving ends.
- Press Function + Enter , or tap OK.

Modifying a Location

If you add a location and later realize you did not use the correct settings, you can modify the location.





To modify a Location:

1. Tap a Location pick list.
2. Select Edit List.
3. Select the location you want to modify.
4. Tap Edit.
5. Adjust the settings. See [“Adding a location”](#) earlier in this chapter for details.
6. Press Function  + Enter , or tap OK.
7. Press Function  + Enter , or tap Done.

Removing a location

If you no longer need a location that appears on the Location list, you can remove it from the list. You cannot remove a location that is currently assigned to the primary location.

To remove a Location:

1. Tap a Location pick list.
2. Select Edit List.
3. Select the location you want to remove.
4. Tap Remove.
5. Press Function  + Enter , or tap OK to confirm deletion.
6. Press Function  + Enter , or tap Done.





Setting an alarm

In addition to setting and displaying the Date & Time, World Clock also provides a convenient travel alarm feature. You can set an alarm to sound during the next 24-hour period.

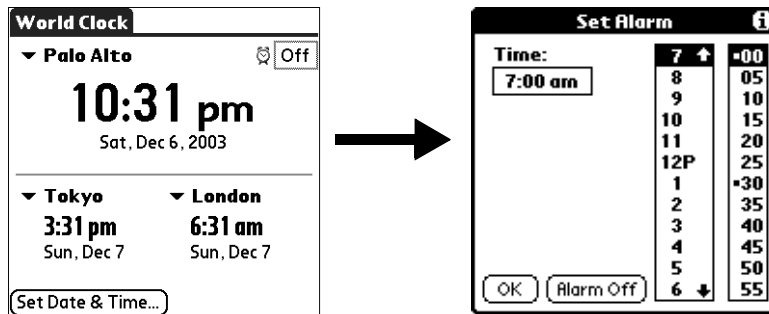
To set an alarm:

1. Tap the box next to the Alarm icon  to open the Set Alarm dialog box.



2. Tap the time columns to set the hour and minute.
3. Press Function  + Enter , or tap OK.
4. When the alarm reminder message appears, do one of the following:
 - Press Function  + Enter , or tap OK to permanently dismiss the reminder and return to the current screen.
 - Tap Snooze to dismiss the reminder and return to the current screen. An attention indicator blinks in the upper-left corner of the screen to remind you of the pending alarm, and the reminder message appears again in five minutes. When the reminder message reappears, the current time is displayed in the Reminder bar and the alarm time appears on the screen.
5. Tap Go To to open World Clock.

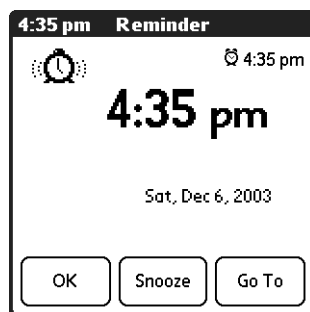

Using World Clock menus

World Clock menus are shown here for your reference, and World Clock features that are not explained elsewhere in this book are described here.

See “Using menus” in [Chapter 4](#) for information about choosing menu commands.

Options menu

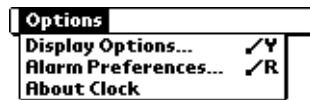

Display Options Opens a dialog box where you can choose which information appears on the World Clock screen.

Show Multiple Locations. Activates the secondary location displays. When it is selected, the secondary locations appear below the primary location.

Show Date. Activates the date display. When it is selected, the date appears below the time for each location.

Alarm Preferences

Sound. Sets the sound of the alarm. The choices are Alarm, Bumble Bee, Reveille, Sonata, Wake Up, and Warbler.

Volume. Defines how loud the alarm sounds. The choices are Low, Medium, and High.

About World Clock

Shows version information for World Clock.

Performing HotSync® Operations

HotSync® technology enables you to synchronize data between one or more Palm OS® handhelds and Palm™ Desktop software or another PIM such as Microsoft Outlook. To synchronize data, you must connect your handheld and Palm Desktop software. You can synchronize your data either directly or indirectly. Direct methods include placing your handheld in the cradle/cable attached to your computer, or using infrared communications. An indirect method is using a modem or network HotSync technology.

Selecting HotSync setup options

You can choose when you want HotSync Manager to run. If necessary, you can adjust the local and modem HotSync settings as well.

To set the HotSync options on a Windows computer:

1. Click the HotSync icon ™ in the Windows system tray.
2. Select Setup.

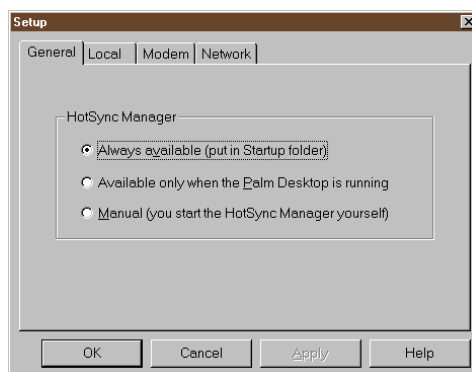

3. Click the General tab and select one of the following options:

Always available Adds HotSync Manager to the Startup folder and constantly monitors the communication port for synchronization requests from your handheld. With this option, the HotSync Manager synchronizes data even when Palm Desktop software is not running.

Available only when Palm Desktop software is running Starts HotSync Manager and monitors requests automatically when you open Palm Desktop software.

Manual Monitors requests only when you select HotSync Manager from the Start menu.

If you're not sure which option to use, keep the default setting: Always available.

4. If you are using a serial cradle/cable, click the Local tab to display the settings for the connection between your computer and the handheld cradle/cable, and adjust the following options as needed.

If you are using the USB cradle/cable, you do not need to use the settings on the Local tab for a direct HotSync operation.

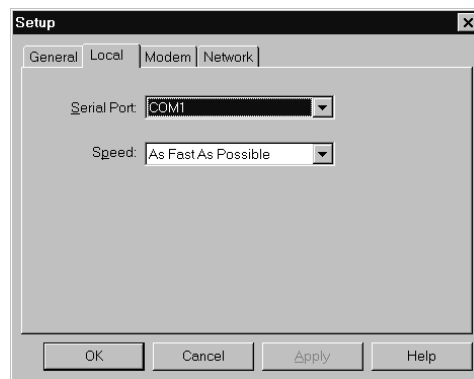

Serial Port Identifies the port that HotSync Manager uses to communicate with the cradle/cable. You can change the port selection.

Your handheld cannot share this port with an internal modem or other device.

Speed Determines the speed at which data is transferred between your handheld and Palm Desktop software. Try the As Fast As Possible rate first, and adjust downward if you experience problems. This setting allows Palm Desktop software and your handheld to find and use the fastest speed.

5. Click the Modem tab to display the modem settings and adjust the options as needed. See [“Conducting HotSync operations using an attached modem”](#) later in this chapter for more information.
6. If you are attached to a network, click the Network tab to display the network settings and adjust the options as needed. For more information, see [“Conducting network HotSync operations”](#) later in this chapter.
7. Click OK.

To set the HotSync options on a Mac:

1. Double-click the HotSync Manager icon in the Palm folder.
2. Click the HotSync Controls tab and select any of the following options.

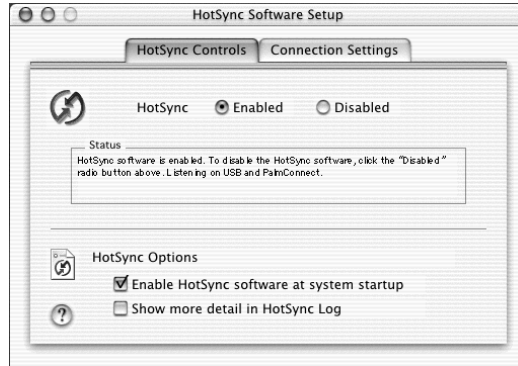

HotSync Enabled/Disabled Activates the HotSync software and prepares your computer to synchronize with your handheld. By default, the transport monitor is enabled whenever you start your computer.

Enable HotSync software at system startup Activates the transport monitor automatically each time you start your computer. If this option is not selected, you must open HotSync Manager and select the Enabled option before you can perform a HotSync operation.

Show more detail in HotSync Log Includes more troubleshooting information in the log that is generated when you perform a HotSync operation.

3. Close the HotSync Software Setup window.

Customizing HotSync application settings

For each application, you can define a set of options that determines how records are handled during synchronization. These options are called a *conduit*. By default, a HotSync operation synchronizes all files between the handheld and Palm Desktop software.

In general, you should leave the settings to synchronize all files. The only reason you might want to change these settings is to overwrite data on either your handheld or Palm Desktop software, or to avoid synchronizing a particular type of file because you don't use it.

In addition to the conduits for Date Book, Address Book, To Do List, Memo Pad, and Note Pad, Palm Desktop software includes System and Install conduits, as well as conduits for the VersaMail™ application. The System conduit backs up the system information stored on your handheld, including ShortCuts. The Install conduit installs add-on applications on your handheld. The conduit for the VersaMail application enables you to select e-mail accounts to synchronize. The VersaMail application is optional and is not installed on all handhelds.

To customize HotSync application settings on a Windows computer:

1. Click the HotSync icon  in the Windows system tray (lower-right corner of the taskbar).

You can also click the HotSync command on the Palm Desktop software menu bar.

2. From the HotSync Manager menu, choose Custom.
3. Select the appropriate username from the list.
4. Select an application in the Conduit list.
5. Click Change, and do one of the following:

VersaMail: Set synchronization options. Click Configure Accounts to change e-mail account settings. The VersaMail application is optional and is not installed on all handhelds.

Other applications: For each application, click the direction in which you want to write data, or click Do Nothing to skip data transfer for an application.

Changing the HotSync setting from the default affects only the *next* HotSync operation. Thereafter, the HotSync Actions revert to their default settings. To use a new setting on an ongoing basis, select the Set as default box. Thereafter, whatever you selected as the default setting is used when you click the Default button in the Custom dialog box.

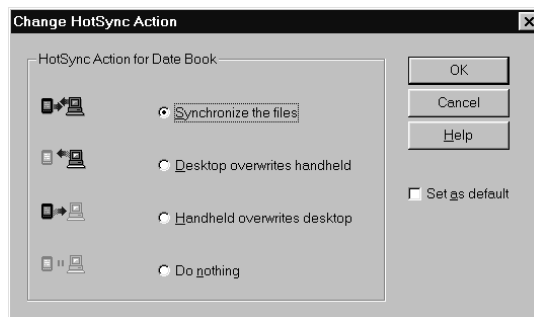

6. Click OK.
7. Click Done to activate your settings.

To customize HotSync application settings on a Mac computer:

1. Double-click the Palm Desktop icon in the Palm folder.
2. From the HotSync menu, choose Conduit Settings.
3. From the User pop-up menu, select the appropriate username.
4. Select an application in the Conduit list.

5. Click Conduit Settings.

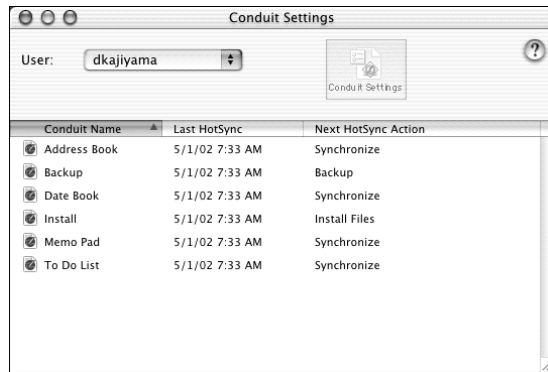

6. For each application, click the direction in which you want to write data, or click Do Nothing to skip data transfer for an application.

Changing the HotSync setting from the default affects only the *next* HotSync operation. Thereafter, the HotSync Actions revert to their default settings. To use a new setting on an ongoing basis, click Make Default. Thereafter, whatever you selected as the default setting is used for HotSync operations.

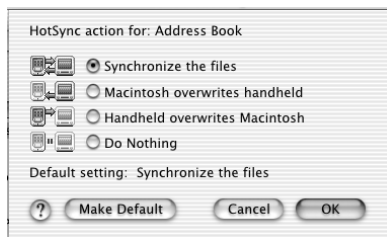

7. Click OK.
8. Close the Conduit Settings window.

Performing cradle/cable HotSync operations

The simplest way to synchronize data is to perform a direct HotSync operation by placing your handheld in the cradle/cable and pressing the HotSync button.

Performing a cradle/cable HotSync operation: Windows computer

The first time you synchronize your data, you need to enter user information on Palm Desktop software. After you enter this information and synchronize, the HotSync Manager recognizes your handheld and doesn't ask for this information again.

If you are a system administrator preparing several handhelds for a group of users, you may want to create a user profile. See [“Using File Link”](#) later in this chapter before performing the following steps.

IMPORTANT You must perform your *first* HotSync operation with a local, direct connection, or with infrared communication, rather than using a modem or network.

The following steps assume that you have already installed Palm Desktop software. If you have not installed this software, see the *Getting Started* installation guide for instructions.

To perform a local HotSync operation on a Windows computer:

1. Place your handheld in the cradle/cable.

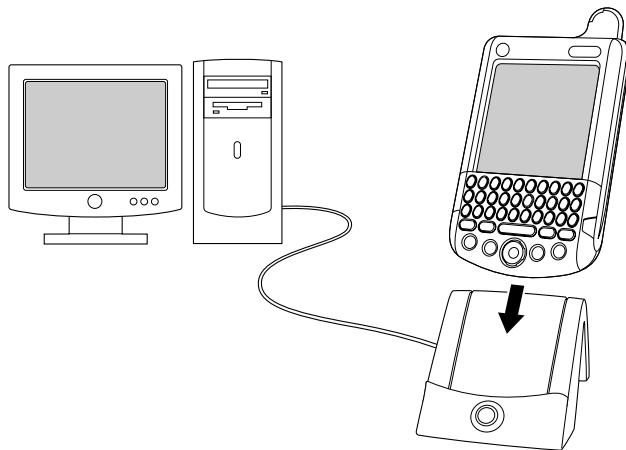

2. If the HotSync Manager is not running, start it: On the Windows desktop, click Start, and then choose Programs. Navigate to the Palm Desktop software program group and choose HotSync Manager. Alternatively, you can start the Palm Desktop software, which automatically opens the HotSync Manager.

3. Press the HotSync button  on the cradle/cable.

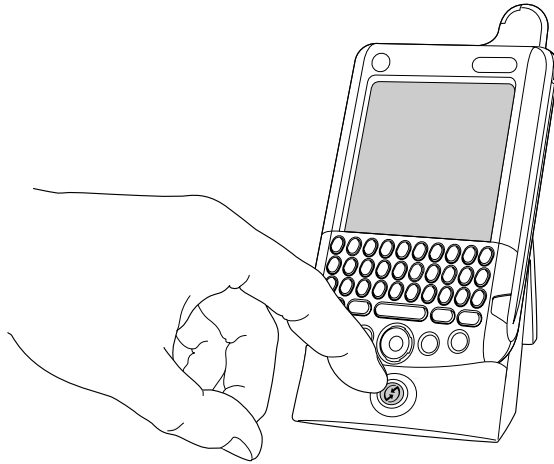

IMPORTANT The first time you perform a HotSync operation, you must enter a username in the New User dialog box and click OK. Every handheld should have a unique name. To prevent loss of a user's records, never try to synchronize more than one handheld to the same username.

The HotSync Progress dialog box appears and synchronization begins.

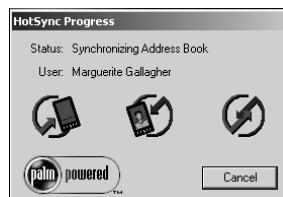

4. Wait for a message on your handheld indicating that the process is complete.

After the HotSync process is complete, you can remove your handheld from the cradle/cable. Gently tilt your handheld forward in the cradle, and then lift it up to remove it.

Performing a direct HotSync operation: Mac computer

When you installed Palm Desktop software, you entered a username. This username is the connection between your handheld and your computer.

The first time you perform a HotSync operation the Palm Desktop software does the following:

- Adds a username to your handheld.
- Creates a folder for the username in the Users folder inside the Palm folder inside the current Mac user's Documents folder. For example, if you entered

Jane Garcia as your username, a folder called Jane Garcia is created in the Users folder.

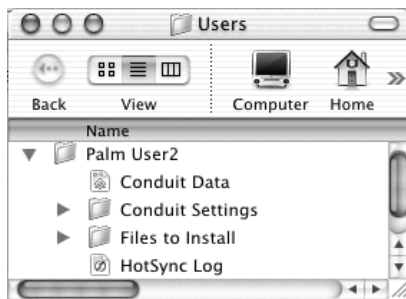

- Creates a file named User Data in your username folder.

Usernames appear in the User pop-up on the right side of the toolbar. You can change users by selecting a new name in the pop-up menu.

Each subsequent time you perform a HotSync operation, HotSync Manager reads the username from your handheld and synchronizes the data in the folder of the same name.

Be sure you select the correct username from the User pop-up before entering data on Palm Desktop or performing a HotSync operation.

If you are a system administrator preparing several handhelds for a group of users, you may want to create a user profile. See [“Creating a user profile”](#) later in this chapter before performing the following steps.

IMPORTANT You must perform your *first* HotSync operation with a local, direct connection, or with infrared communication.

The following steps assume that you have already installed Palm Desktop software. See the *Getting Started* installation guide if you have not installed this software.

To perform a local HotSync operation on a Mac computer:

1. Place your handheld in the HotSync cradle/cable.

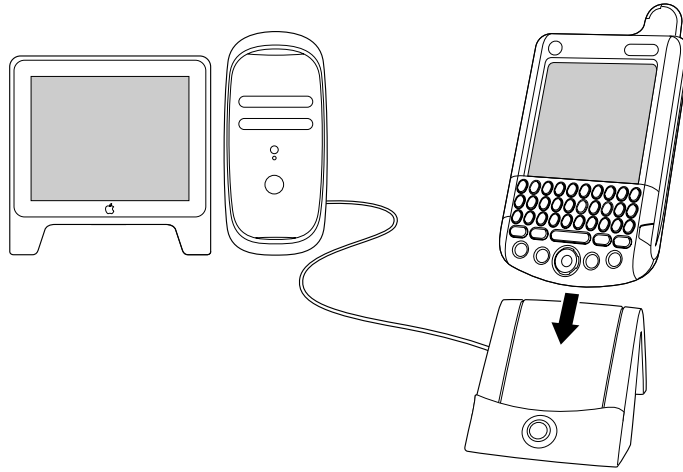

2. Make sure HotSync Manager is enabled: Double-click the HotSync Manager icon in the Palm folder. Click the HotSync Controls tab and make sure the Enabled option is selected.
3. Press the HotSync button  on the cradle/cable.

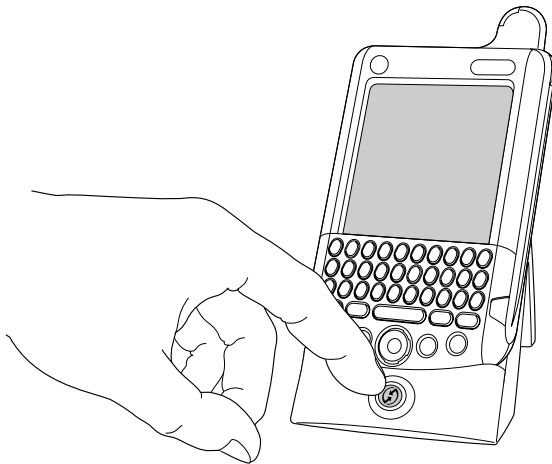

The HotSync Progress dialog box appears, followed by the Select User dialog box.

- In the Select User dialog box, select the username you entered when you installed the Palm Desktop software, and click OK.

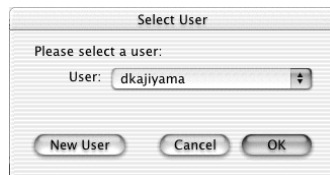

The HotSync Progress dialog box reappears, and synchronization begins.

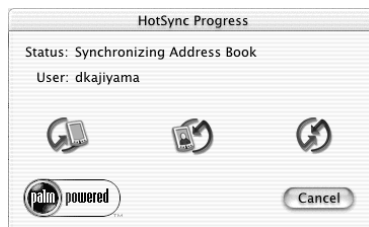

- Wait for a message on your handheld indicating that the process is complete.

After the HotSync process is complete, you can remove your handheld from the cradle/cable. Gently tilt your handheld forward in the cradle, and then lift it up to remove it.

Conducting IR HotSync operations

You can use the infrared (IR) port on your handheld to perform HotSync operations. When you perform an IR HotSync operation, you don't need your cradle/cable. However, you must have a computer that's equipped with an IR port and that supports the IrCOMM implementation of the Infrared Data Association (IrDA) standards. This is especially useful if you travel with an infrared-enabled laptop. You simply enable infrared communication on your laptop and handheld and follow the steps in [“Performing an IR HotSync operation”](#) later in this section.

Preparing your computer for infrared communication

Before you can perform a HotSync operation using the IR port, the computer with which you want to synchronize must fulfill these requirements:

- Your computer must support the IrCOMM implementation of the IrDA standards.
- Your computer must have an enabled infrared port that's built into the computer, or an enabled infrared device attached to the computer.
- Some desktop computers may require an infrared device attached to a physical COM port. Laptops are likely to have a built-in IR port, so no external device is necessary.

- Your computer must have an installed infrared driver.
- If you have an external infrared device attached to your computer, a driver is probably included with the device. Consult the documentation included with the device for information on installing the required driver.

Check your computer's documentation to learn if the computer supports infrared communication.

To configure HotSync Manager for infrared communication on a Windows computer:

- Click the HotSync Manager icon  in the Windows system tray, and make sure that Infrared is checked.
 - If you have an Infrared option on the HotSync Manager menu, and that option is selected, skip to [“Performing an IR HotSync operation.”](#)
 - If you do not have an Infrared option on the HotSync Manager menu, complete the following steps:
 - a. Make sure that Local Serial is selected on the menu.
 - b. From the HotSync Manager menu, select Setup.
 - c. Click the Local tab.
 - d. In the Serial Port drop-down box, select the simulated port that your computer uses for infrared communication.

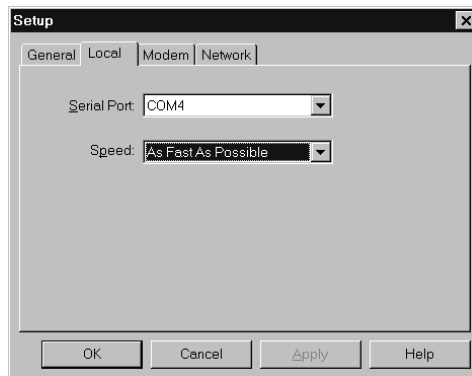

See the documentation for your operating system for instructions on finding the simulated port. This information is usually located in the Control Panel.

- Click OK.

NOTE If your cradle/cable is connected to a USB port, you can continue using it while HotSync Manager is configured for infrared communication. If your cradle/cable is connected to a serial port, you cannot use your HotSync cradle/cable again until you reconfigure the HotSync Manager to communicate with the port defined for cradle/cable synchronization.

To configure HotSync Manager for infrared communication on a Mac computer:

1. Double-click the HotSync Manager icon in the Palm folder.
2. In the HotSync Controls tab, select Enabled.
3. Click the Connection Settings tab.
4. Select the On check box next to IR Port.

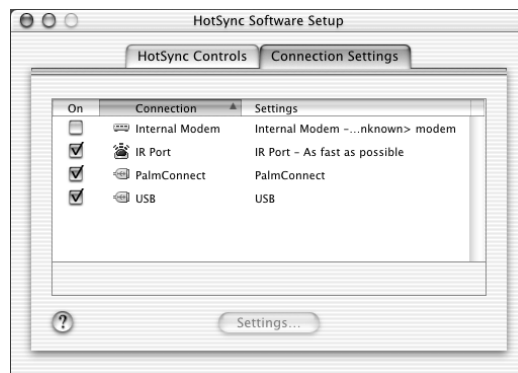

5. Close the HotSync Software Setup window.

Performing an IR HotSync operation

After you complete the steps to prepare for performing an IR HotSync operation, it's easy to perform the actual operation.

To perform an IR HotSync operation:

1. Press Home (⏪).
2. Tap the HotSync icon (🔄).
3. Tap Local.
4. Tap the pick list below the HotSync icon and select IR to PC/Handheld.
5. Position the IR port of your handheld within a couple of inches of the infrared port of your computer.
6. Tap the HotSync icon to start the IR HotSync operation.

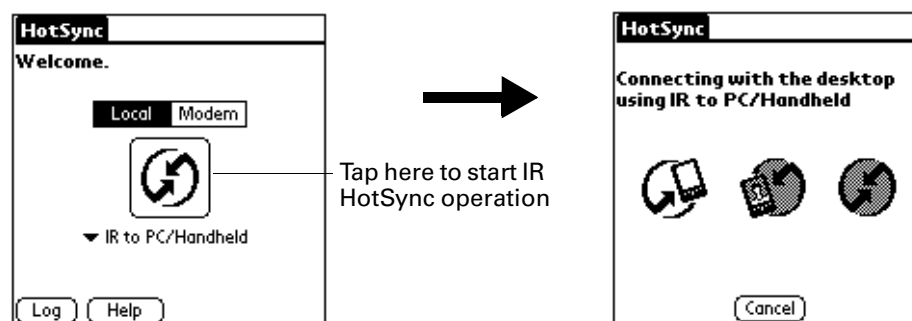

Returning to cradle/cable HotSync operations

It's easy to return to using the cradle/cable for HotSync operations.

If your cradle/cable is connected to a USB port, you can continue using it while HotSync Manager is configured for infrared communication. Use the following instructions to return to Local USB cradle/cable HotSync operations only when necessary, such as when you have disconnected the cradle/cable from the USB port.

To return to local USB cradle/cable HotSync operations on a Windows computer:

1. If necessary, connect the cradle/cable to the USB port of the computer you use for HotSync operations.
2. Click the HotSync Manager icon  in the Windows system tray, and select Local USB if it is not already selected.

To return to local serial cradle/cable HotSync operations on a Windows computer:

1. If necessary, connect the cradle/cable to the port of the computer you use for HotSync operations.
2. Click the HotSync Manager icon  in the Windows system tray.
3. Choose Setup, and then click Local.
4. Select the COM port where your cradle/cable is connected.
5. Click OK.

To return to local serial cradle/cable HotSync operations on a Mac computer:

1. If necessary, connect the cradle/cable to a serial port on your computer.
2. Double-click the HotSync Manager icon in the Palm folder.
3. In the HotSync Controls tab, select Enabled.
4. Click the Connection Settings tab, and select the correct connection.
5. Close the HotSync Software Setup window.

The next time you want to perform a HotSync operation, just press the HotSync button on the cradle/cable, as you always did before.

Conducting HotSync operations using an attached modem

You can use your attached modem to synchronize your handheld when you are away from your computer.

IMPORTANT You cannot perform a wireless HotSync operation using your handheld's mobile radio.

The first HotSync operation must be performed using a local, direct connection, or with infrared communication. After that, you can perform a HotSync operation using an attached modem.

To perform a HotSync operation using your attached modem you need the following:

- A modem connected to your computer.
- Palm Desktop software configured for use with the modem.
- A modem connected to your handheld.
- A configuration for the kind of modem connection you want to make. See [“Connection preferences”](#) in [Chapter 21](#) for more information.

Preparing your computer for a modem HotSync operation

There are a few steps you must perform to prepare your computer for a modem HotSync operation. Be sure to perform these steps before you leave your office so that your computer is ready to receive a call from your handheld.

To prepare your Windows computer for a modem HotSync operation:

1. Confirm that the computer modem is connected and turned on, and that no communications applications, such as fax or telephony software, are running on a COM port.

Make sure the computer is disconnected from all online services, such as America Online (AOL). This helps to avoid conflicts with the COM port.

2. Start HotSync Manager if it is not already running, and from the HotSync Manager menu, select Modem.

- Adjust the following options as needed.

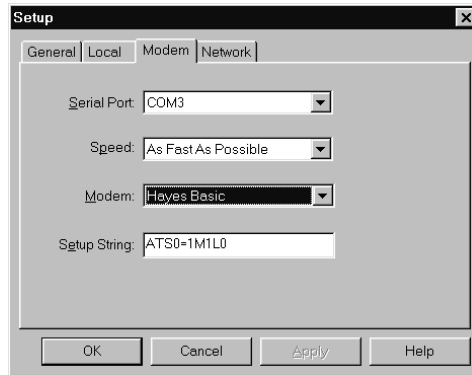

Serial Port Identifies the port for the modem. If you are unsure of the port assignment, look at the Modem Properties in the Windows Control Panel.

Speed Determines the speed at which data is transferred. Try the As Fast As Possible rate first, and adjust downward if you experience problems. This setting allows Palm Desktop software and your handheld to find and use the fastest speed.

Modem Identifies the modem type or manufacturer. Refer to your modem manual or faceplate for its type or settings. If you're not sure of your modem type or your modem doesn't match any that appear in the list, select Hayes Basic.

Setup String Identifies the setup string for your particular modem. Not all modems require a setup string. Refer to your modem manual and enter the setup string if recommended by the manufacturer.

- Click OK.

To prepare a Mac computer for a modem HotSync operation:

- Confirm that the computer modem is connected and turned on, and that no communications applications, such as fax or telephony software, or AppleTalk networking are running on that serial port.

NOTE Make sure your computer is disconnected from all online services, such as CompuServe and America Online (AOL). This helps to avoid conflicts with the serial port. In addition, your computer must be on, and it should not be in sleep mode when receiving a call from a remote handheld.

- Double-click the HotSync Manager icon in the Palm folder.
- Click the HotSync Controls tab and enable the Transport Monitor, if it is not already enabled.
- Click the Connection Settings tab.

5. Select the On check box of the modem connection you're using, and then click Settings.
6. In the Settings dialog box, select Modem as the connection type, if it is not already selected. This step is not necessary for internal modems.
7. Adjust the following options as needed.

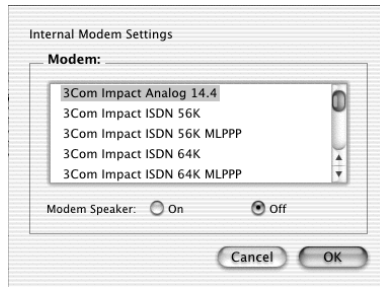

Modem Identifies the type of modem connected to your computer. If your modem does not appear on the list, use the Hayes Basic setting, or select Custom to enter a command string. Refer to the manual that came with your modem to find the appropriate command string.



Modem Speaker Activates the modem's speaker. If you are having trouble connecting, turn on this option to make sure that the modem connected to your computer is responding to incoming calls.

8. Click OK.
9. Close the HotSync Software Setup window.

Preparing your handheld for a modem HotSync operation

There are a few steps you must perform to prepare your handheld for a modem HotSync operation.

To prepare your handheld for a modem HotSync operation:

1. Press Home .
2. Tap the HotSync icon .
3. Tap Modem.

4. Tap the pick list below the icon and select a modem configuration.

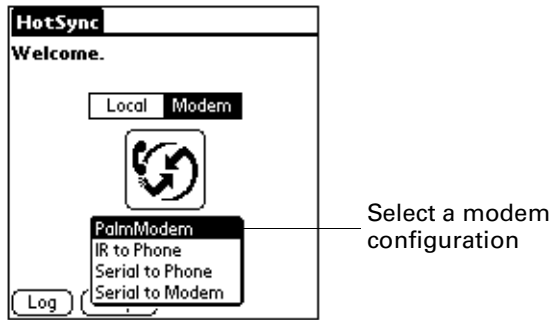

5. If you need to create a configuration, press Command Stroke (⌘) + S.
Alternately, press Function (F) + Menu (⌘), and then select Connection Setup on the Options menu.

See [“Connection preferences”](#) in [Chapter 21](#) for more information.

6. Tap the Enter phone # field.

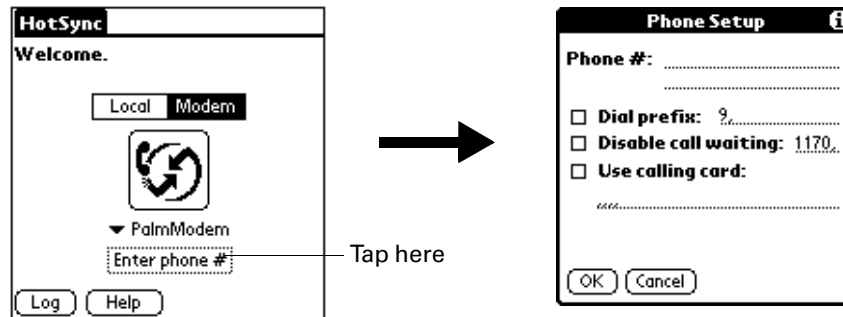

If you plan to connect to your company’s dial-in server (network modem) instead of connecting to a computer modem, see [“Using File Link”](#) later in this chapter.

7. Enter the telephone number to access the modem connected to your computer.
8. If necessary, enter a dial prefix (such as “9”) to access an outside line, and then tap the Dial Prefix check box to select it.



TIP You can enter a comma in the field to introduce a “pause” in the dialing sequence. Each comma equals a two-second pause.



9. If the phone line you’re using for the handheld has call waiting, select the Disable call waiting check box to avoid an interruption during the modem HotSync operation.
10. If you want to use a calling card to place the call, select the check box and enter the calling card number.
11. Tap OK.

Selecting the conduits for a modem HotSync operation

The Conduit Setup dialog box on your handheld enables you to define which files and/or applications synchronize during a modem HotSync operation. You can use these settings to minimize the time required to synchronize data with a modem.

To change the Conduit Setup for a modem HotSync operation:

1. Press Home .
2. Tap the HotSync icon .
3. Press Command Stroke  + D.

Alternately, press Function  + Menu , and then select Conduit Setup on the Options Menu.

4. Tap the check boxes to deselect the files and applications that you do *not* want to synchronize during a modem HotSync operation. The default setting is to synchronize all files.

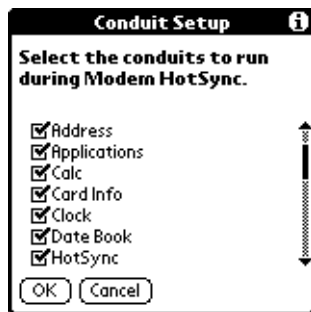



Applications that do not have a database (such as games) do not synchronize, even if you select the item in the Conduit Setup dialog box.

5. Tap OK.

Performing a HotSync operation using an attached modem

After you prepare your computer and your handheld and select your Conduit Setup options, you are ready to perform a modem HotSync operation.

To perform a modem HotSync operation:

1. Press Home .
2. Tap the HotSync icon .
3. Tap the Modem icon  to dial the Palm Desktop modem and synchronize the applications.
4. Wait for the HotSync operation to complete. If you have any problems conducting a successful HotSync operation, see [“HotSync problems”](#) in [Appendix B](#).

Conducting network HotSync operations

When you use the network HotSync technology, you can take advantage of the LAN and WAN connectivity available in many office environments. Network HotSync technology enables you to perform a HotSync operation by using Bluetooth technology or an 802.11 accessory to make a wireless connection to a network, by dialing in to a network, or by using a cradle/cable that is connected to any computer on your LAN or WAN (provided that the computer connected to the cradle/cable also has the network HotSync technology installed, your computer is on, and the HotSync Manager is running).

NOTE Network HotSync technology is available only on Windows computers and when dialing into the corporate network. Network HotSync is not available if the desktop computer is located behind a firewall.

Connecting to your company's dial-in server

A network HotSync operation requires the following (consult your system administrator for assistance):

- Your computer has TCP/IP support installed.
- Both your company's network system and its remote access server support TCP/IP.
- You have a remote access account.

Everything you need for connecting to your company's dial-in server (network modem) is included with Palm Desktop software and handheld software. You need to activate the feature, however, on both Palm Desktop software and your handheld.

To prepare your computer for a network HotSync operation:

1. Click the HotSync Manager icon  in the Windows system tray.
2. From the HotSync Manager menu, select Network.

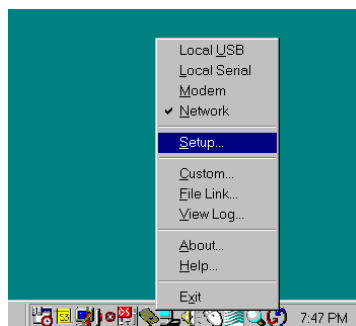

3. From the HotSync Manager menu, select Setup.

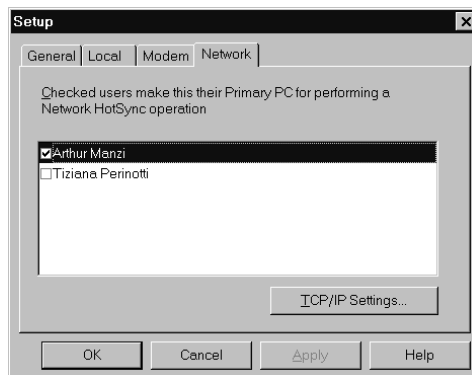

- Click the Network tab and make sure your user name has a checkmark next to it. If the checkmark is not there, click the check box next to your user name.





- Click OK.
- Put your handheld in the cradle/cable, and perform a HotSync operation.

The HotSync operation records network information about your computer on your handheld. With this information, your handheld can locate your computer when you perform a HotSync operation over the network.

To prepare your handheld for a network HotSync operation:

- Press Home .
- Select the HotSync icon .
- Press Command Stroke  + O.

Alternately, press Function  + Menu , and then select Modem Sync Prefs on the Options Menu.

- Tap Network.

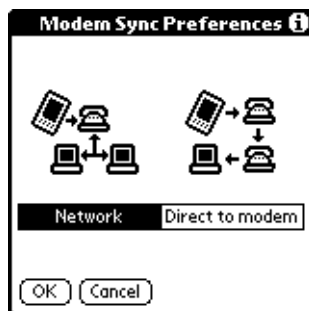

- Tap OK.

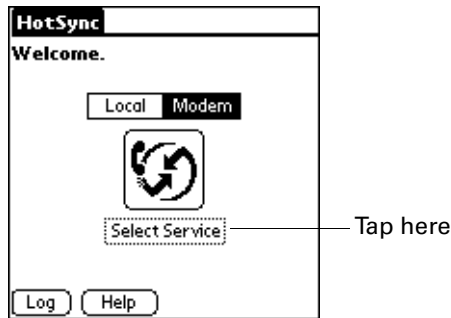

6. Tap Select Service.



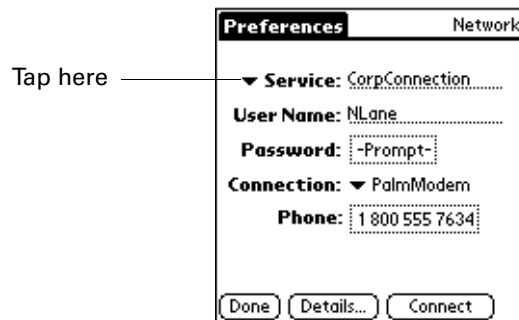

NOTE See [“Network preferences”](#) in [Chapter 21](#) for information on creating a network connection.

7. Tap Service and select a service.



8. Press Function  + Enter , or tap Done.
9. Press Command Stroke  + D.

Alternately, press Function  + Menu , and then select Conduit Setup on the Options Menu.

For instructions on selecting conduits, see [“Selecting the conduits for a modem HotSync operation”](#) earlier in this chapter.

Performing a network HotSync operation

After you prepare your computer and your handheld and select your Conduit Setup options, you are ready to perform a network HotSync operation.

To perform a network HotSync operation:

- Tap the modem HotSync icon to begin the operation.

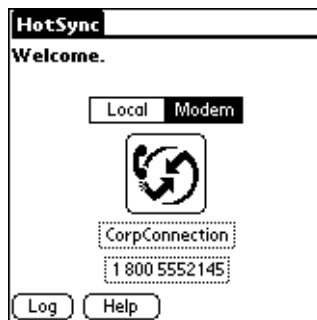

Using File Link

The File Link feature enables you to import Address Book and Memo Pad information onto your handheld from a separate external file such as a company phone list. HotSync Manager stores the data in a separate category on your Palm Desktop software and on your handheld. You can configure the File Link feature to check for changes to the external file when you perform a HotSync operation.

With File Link you can import data stored in any of the following formats:

- Comma-separated (*.csv)
- Memo Pad archive (*.mpa)
- Address Book archive (*.aba)
- Text (*.txt)

For information on how to set up a file link, see the Palm Desktop online Help.

NOTE The File Link feature is not available in Palm Desktop software for Mac.

Creating a user profile

A user profile enables you to install the same set of data onto multiple Palm OS handhelds before each handheld is individualized with a specific user name and data file.

A handheld that is preconfigured with a user profile can be given to anyone because the handheld is not yet identified by a unique user name. The handheld acquires a unique user name when the new user performs his or her first local HotSync operation.

For example, suppose a sales organization wants to distribute two dozen handhelds that each have a common company phone list, a set of memos, and several key applications. A user profile can be created to install the common data before the handhelds are distributed to the employees who will use them. Then when the employees perform their first HotSync operation, the common data becomes part of their individual data file.

NOTE The handhelds that are synchronized with a user profile must be either new ones that have never been synchronized or handhelds that have had their user names and data removed by a hard reset.

To create a user profile on a Windows computer:

1. Open Palm Desktop software.
2. From the Tools menu, select Users.
3. Click Profiles.
4. Click New.

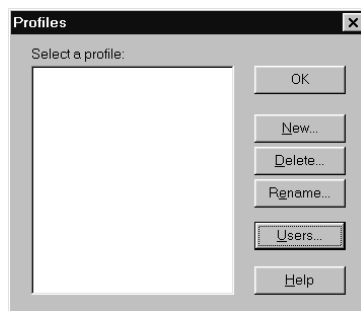

5. Enter a unique name for the profile and click OK.



6. Repeat steps 3 through 5 for each profile that you want to create, and then click OK to return to Palm Desktop software.

7. Select the profile from the User list, and create the data for the profile (for example, a company phone list).

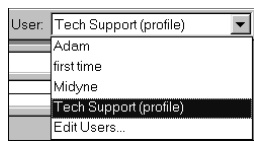

To create a user profile on a Mac computer:

1. Open Palm Desktop software.
2. From the User pop-up menu, select Edit Users.
3. Click New Profile.

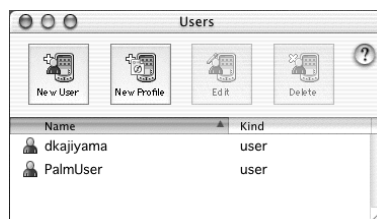

4. Enter a unique name for the profile and click OK.



5. Close the Users window.
6. From the User pop-up menu, select the new profile.
7. Create the data for the profile (such as a company phone list).
8. From the HotSync menu, select Conduit Settings.
9. Select the conduit settings for the profile. See [“Customizing HotSync application settings”](#) earlier in this chapter for details.

Performing the first HotSync operation with a user profile

After you create a user profile, you are ready to transfer the information to the new handheld during the first HotSync operation.

To use a profile for the first-time HotSync operation on a Windows computer:

1. Place the new handheld in the cradle/cable.
2. Press the HotSync button  on the cradle/cable.
3. Click Profiles.

4. Select the profile you want to load on the handheld, and click OK.

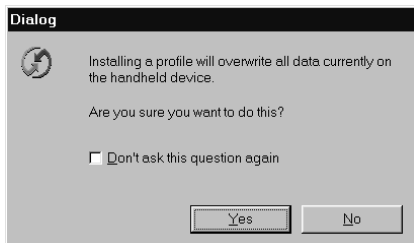

5. Click Yes to transfer all the profile data to the handheld.

The next time you perform a HotSync operation, Palm Desktop software prompts you to assign a username to the handheld.

To use a profile for the first-time HotSync operation on a Mac computer:

1. Connect the new handheld to the HotSync cradle/cable.
2. Press the HotSync button  on the cradle/cable.
3. Select the profile you want to load on the handheld, and click OK to transfer all the profile data to the handheld.

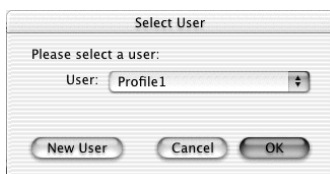

The next time you perform a HotSync operation, Palm Desktop software prompts you to assign a username to the handheld.



Setting Preferences for Your Handheld

The Preferences screens enable you to customize the configuration options on your handheld, including the following:

Buttons	Reassign different applications to the buttons on the front panel of your handheld, and the HotSync® button on the cradle.
Connection	Configure cradle, modem, and infrared communication settings.
Date and Time	Set the date, time, time zone, and Daylight Saving switch.
Digitizer	Calibrate the screen on your handheld.
Formats	Set the country default and the formats for dates, times, calendar, and numbers.
General	Set these features: auto shutoff interval, Stay on in cradle, sounds, vibrator, indicator light, and Beam Receive.
Keyboard	Configure your keyboard functions.
Mobile	The Mobile Panel allows you to configure many of the wireless settings for the applications sharing configuration settings.
Network	Configure your handheld for use with a network.
Owner	Assign your name, phone number, and other owner information to your handheld.
Security	Set the security features for your handheld.
ShortCuts	Define a list of abbreviations.

Viewing Preferences

To open the Preferences screens:

1. Press Home .
2. Tap the Preferences icon .
3. Tap the pick list in the upper-right corner of the screen.
4. Select the Preferences screen you want to view.

Buttons preferences

The Buttons Preferences screen enables you to associate different applications with the buttons on the front of the handheld.

Any changes you make in the Buttons Preferences screen become effective immediately; you do not have to change to a different screen or application.

If you assign a different application to a button, you can still access the original application using the Applications Launcher.

To change the Buttons preferences:

1. Tap the pick list next to the button you want to reassign.

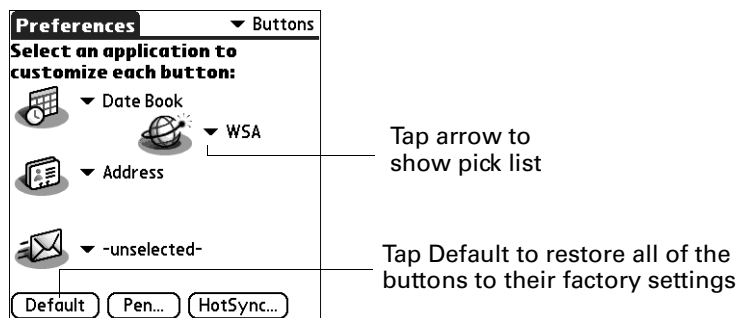

2. Select the application that you want to assign to the button.

Connection preferences

IMPORTANT The connections preferences may have been set by your wireless service provider. Check with your provider before changing the preset settings.

The Connection Preferences screen enables you to define the settings used to connect your handheld to other devices. The screen displays a list of available configurations that are ready to be further defined; the list varies depending on the kind of software you've added to your handheld.

You can also create custom configurations, which include the following:

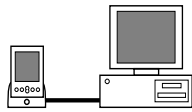

PC via Cradle/Cable: A local HotSync connection; the direct connection between your handheld and your desktop computer. Your handheld is connected by its universal connector to the cradle, and the cradle is attached by its cable to a USB port of your desktop computer. (If you are using the optional serial cradle, the cradle attaches by its cable to a serial [COM] port of your computer.)

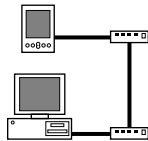

Modem via Universal Connector: A cable connection between your handheld's universal connector and a modem for dialing in to a modem that is part of your computer or laptop.



PC via Infrared: A connection between the IR port of your handheld and the infrared device of your computer or laptop.

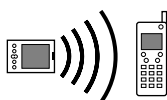

Modem via Infrared: A connection between the IR port of your handheld and a modem. The modem can be attached to or within a mobile phone or some other device containing an IR port. (Some IR phones contain modems.)

Creating and editing GPRS connections

IMPORTANT Your wireless service provider may have set your GPRS connection settings. Different settings may affect your service. Contact your wireless service provider before using different settings.

To add or edit a GPRS connection:

1. Do one of the following:
 - To add: Tap New.
 - To edit: Tap the GPRS connection and tap Edit.

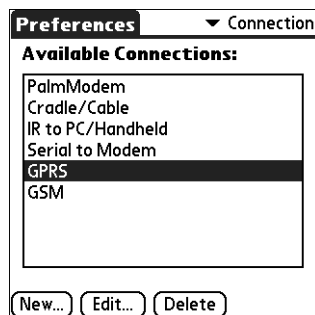

2. Do one of the following:
 - To add: Enter name and tap Details.
 - To edit: Tap Details.

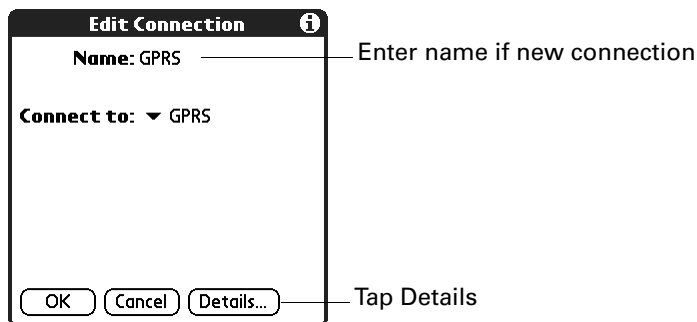

3. Adjust settings.

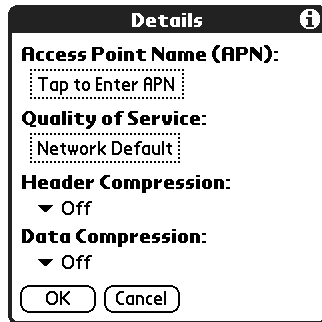

Access Point Name Opens a dialog box that allows you to change the address on the GPRS network in which data is routed through to outside networks—for example, a specific gateway to the Internet or a specific WAP gateway.

Quality of Service Opens up a dialog box that allows you to choose between using the network default settings for quality service or customizing individual settings.

NOTE The quality of service settings are only a request made to the network. The network may or may not grant the level of quality requested, depending on current network conditions and services provided on an individual basis.

Header Compression Sets whether the GPRS data headers are compressed or not. Compressing before transmission aids in increasing transmission speed.

Data Compression Sets whether transmitted data is compressed or not compressed. Compressing data aids in increasing transmission speed.

4. Tap the box under Quality of Service and adjust settings.

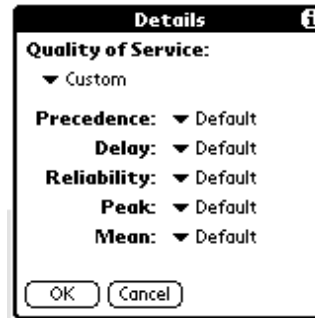
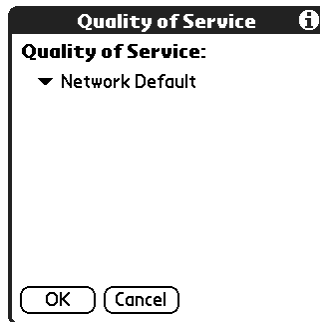

- Network Default** Sets the quality to what the GPRS network currently is providing.
- Custom** Allows you to adjust the individual quality settings.
- Precedence** Changes the requested priority that your data receives in times of network congestion. A higher priority results in privileged handling of your data by the network.
- Delay** Sets the requested maximum time it takes for your data to travel through the network. Best Effort sets all data to be handled in a first in, first out manner.
- Reliability** Sets the requested level of acceptable data loss and timeliness of data delivery that the network provides for data from the device.
- Class 1 is for non-time, error-sensitive applications that cannot cope with data loss.
 - Class 2 is for non-time, error-sensitive applications that can cope with infrequent data loss.
 - Class 3 is for non-time, error-sensitive applications that can cope with data loss and some interruption.
 - Class 4 is for time and error-sensitive applications that can cope with data loss.
 - Class 5 is for time, non-error-sensitive applications that can cope with data loss.
- Peak** Sets the maximum rate of data sent through the network per second.
- Mean** Sets the requested maximum rate of data sent through the network averaged over all of the data transmitted.

5. Press Function  + Enter , twice or tap OK twice.

Creating and editing GSM connections

IMPORTANT Your wireless service provider may have set your GSM connection settings. Changing the settings may affect your service. Contact your wireless service provider before making changes to the settings.

To create or edit a GSM connection:

1. Do one of the following:
 - To add: Tap New.
 - To edit: Tap the GSM connection and tap Edit.

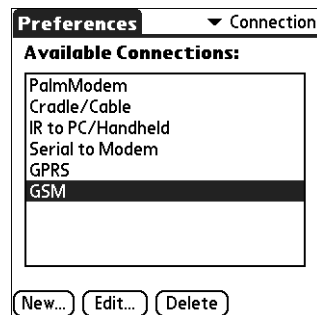

2. Do one of the following:
 - To add: Enter name and tap Details.
 - To edit: Tap Details.

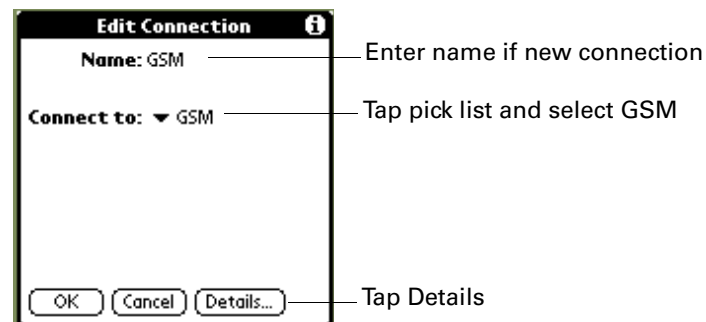

3. Tap the pick lists, select the settings, and then tap OK.

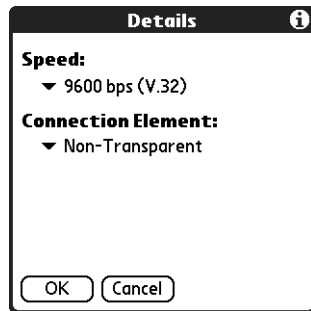

Speed Sets the modem rate and protocol used for the connection. Autobauding automatically negotiates the best modem rate and protocol at the beginning of the connection.

Connection Element Sets the connection as Transparent or Non-Transparent.

4. Press Function + Enter , or tap OK.

IR to PC connection

The following example shows you how to edit the IR to PC/Handheld connection to adjust the communication speed; you can similarly edit other connections or settings or create a custom connection. You can use the IR to PC/Handheld connection to perform a remote IR HotSync operation. To accomplish the HotSync operation, your handheld sends data through its IR port to an IR port in your desktop computer, to synchronize with your Desktop application.

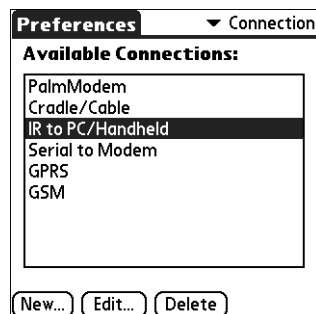

To edit the IR to PC/Handheld connection:

1. Tap the IR to PC/Handheld connection and tap Edit.

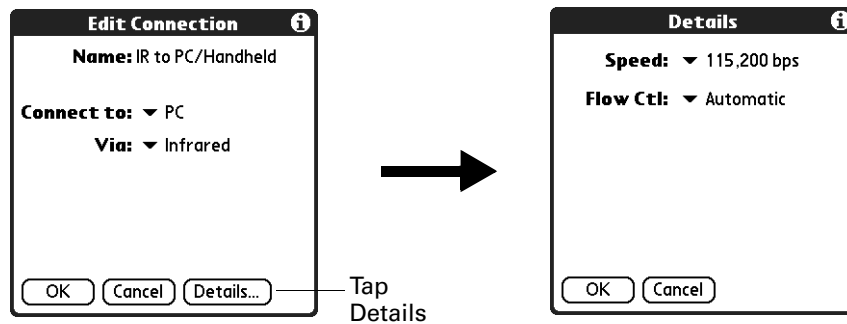

2. Tap Details.



3. Tap the Speed pick list and select the appropriate speed.
4. Enter the initialization string supplied by the documentation for the modem attached to your mobile phone, if necessary.
5. Press Function + Enter , or tap OK.
6. Press Function + Enter , or tap OK again to save the configuration.

After you create the configuration, you need to set up the HotSync Manager of your Desktop application and the HotSync application of your handheld to perform a modem HotSync operation.

Date and Time preferences

The Date and Time Preferences screen enables you to set the date, time, time zone, and Daylight Saving option on your handheld.

To set the date:

1. Tap the Set Date box.
2. Tap the arrows to select the current year.

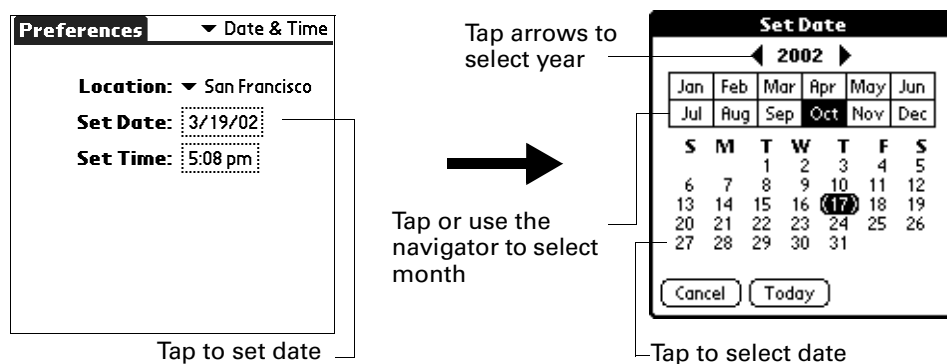

3. Select a month.
4. Tap the current date.

To set the time:

1. Tap the Set Time box.

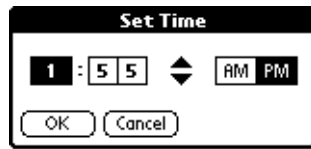

2. Tap the up or down arrows to change the hour.
3. Tap each number of the minute, and then tap the arrows to change the numbers.
4. Press Function + Enter , or tap OK.

To set the time zone:

1. Tap the Location pick list.

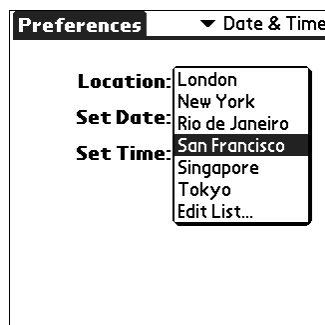

2. Select a time zone.

When you travel, changing the time zone setting to a new time zone automatically resets the date and time on your handheld, but it does not change the time of appointments set in Date Book.

Digitizer preferences

The Digitizer Preferences screen opens the digitizer calibration screen. This is the same screen that appears when you start your handheld for the first time.



You can recalibrate your screen after a hard reset, or if your digitizer drifts.

Formats preferences

Use the Formats Preferences screen to set the country default and the display format of the dates, times, and numbers on your handheld.

Country default

The country default sets date, time, week start day, and number conventions based on geographic regions where you might use your handheld. For example, in the United Kingdom, time often is expressed using a 24-hour clock. In the United States, on the other hand, time is expressed using a 12-hour clock with an AM or PM suffix.

All your handheld applications use the Country default settings. You can, however, customize your own preferences as described in [“Time, date, week start, and numbers formats”](#) later in this chapter.

To set the country default:

- Tap the Preset to pick list and select a country.

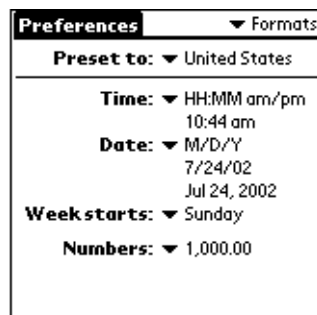

Time, date, week start, and numbers formats

The Time setting defines the format for the time of day. The time format that you select appears in all applications on your handheld.

To select the time, date, week start, and numbers format:

1. Tap the Time pick list and select a format.
2. Tap the Date pick list and select a format.
3. Tap the Week starts pick list, and select whether you want the first day of the week to be Sunday or Monday.

This setting controls the Day, Week, and Month views in Date Book and all other aspects of your handheld that display a calendar.

4. Tap the Numbers pick list, and select formats for the decimal point and thousands separator.

General preferences

The General Preferences screen enables you to set the auto shutoff interval, alarm options, sounds for your handheld, and the Beam Receive feature.

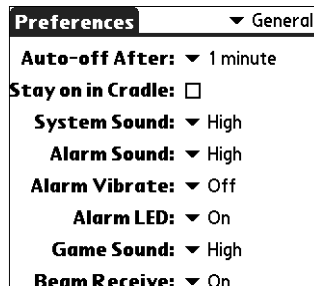

Auto-off delay

Your handheld has an automatic shutoff feature that activates after a period of inactivity. This feature turns off the power and backlight but leaves the radio on. This feature helps conserve battery power in case you forget to turn off your handheld.

If you find that your handheld shuts itself off before you finish reviewing the information on the screen, you should increase the time setting of the automatic shutoff feature.

To set the Auto-off delay:

1. Tap the Auto-off After pick list.
2. Select the setting you want to use for the automatic shutoff feature: 30 seconds, 1 minute, 2 minutes, or 3 minutes.

Cradle settings

You can choose to leave your handheld on when it is in the cradle during a HotSync operation, or when you are recharging the battery, so you can continue to view your data.

To change the cradle setting:

- Tap the Stay on in Cradle check box to leave your handheld on when it is in the cradle.

System, alarm, and game sounds

Your handheld uses a variety of sounds. The System, Alarm, and Game Sound settings enable you to turn the sounds on or off, and to adjust the volume level.

To set the system and alarm sounds:

1. Tap the System Sound pick list and select the sound level.

IMPORTANT When you turn off the System Sounds, you also turn off the “chime” tones associated with the HotSync operation.

2. Tap the Alarm Sound pick list and select the sound level.
3. Tap the Game Sound pick list and select the sound level.

The Game Sound setting works only with games that are programmed to respond to this setting. Older games typically do not respond to this setting.

Alarm Vibrate and indicator light settings

You can set alarms in Date Book, Note Pad and World Clock to remind you of important meetings or notes. When you enable the Alarm Vibrate and indicator light settings, your handheld vibrates and the indicator light blinks to notify you of alarms. This is useful whenever you want to turn the Alarm Sound off but still be notified of alarms.

To set the Alarm Vibrate and indicator light settings:

1. Tap the Alarm Vibrate pick list and select On or Off.
2. Tap the Alarm LED pick list and select On or Off.

Beam Receive

You can choose to turn off the Beam Receive feature. This prohibits anyone from beaming information to your handheld. It also results in a slight saving of battery power.

To change the Beam Receive setting:

- Tap the Beam Receive pick list and select On or Off.

Keyboard Preferences

The Keyboard Preferences screen enables you to customize the keyboard. You can set how each key responds when pressed or held. You can also remap the character or function of the key.

Any changes you make in the Keyboard Preferences screen become effective immediately; you do not have to change to a different screen or application.

To set the key repeat rate:

- Move the slider or tap the adjustment bar.

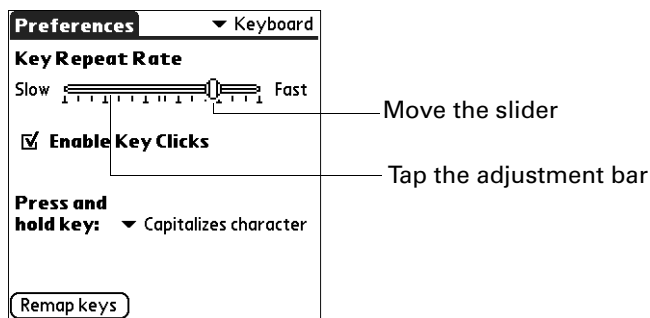

To set key clicking:

- Tap check box to enable or disable key clicking.

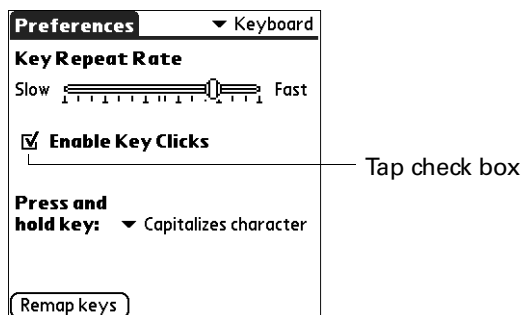

To set key press-and-hold functionality:

- Tap the Press and hold key pick list, and select the function.

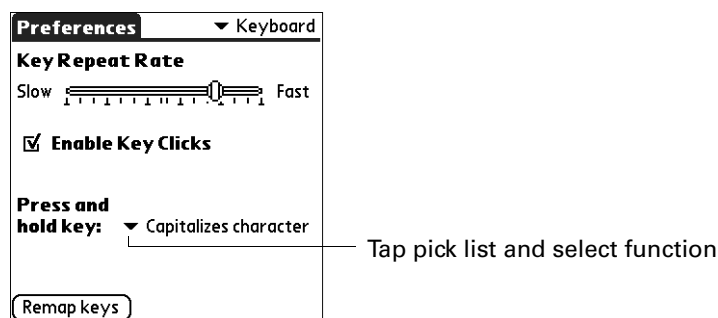

Remapping keys

Keys can be remapped from their default function to any of the keys or buttons available on the handheld, including the Function keys.

To remap a key:

1. Tap Remap keys.
2. Tap a key.

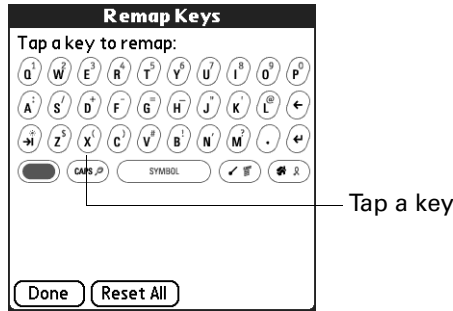

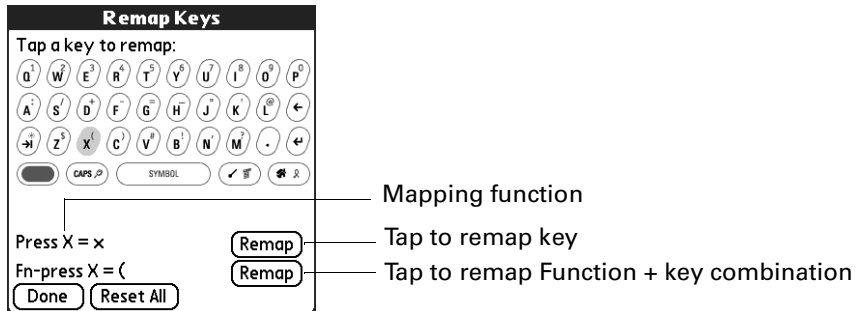

3. Tap Remap.

You can chose to remap the key and the Function + key combination.

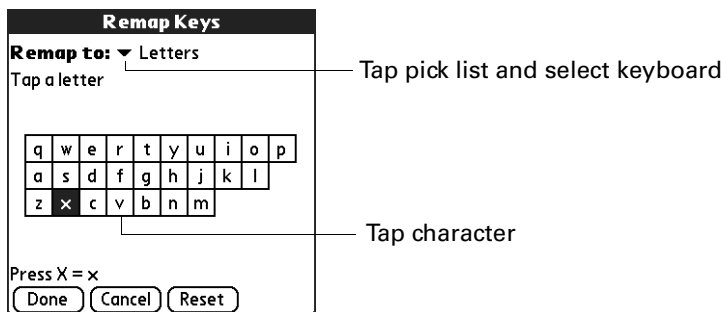

4. Tap Save.



5. Press Function  + Enter , or tap Done.

Mobile preferences

The Mobile Preferences screen allows you to view and configure many of the wireless settings for the applications sharing configuration settings. You can also turn the mobile radio on and off.

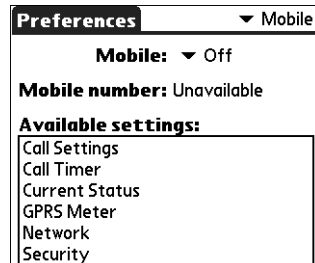

Turning the mobile radio on and off

When you open a wireless application, the radio dialog box automatically appears if the mobile radio is turned off. You can also turn on the mobile radio from the Mobile Preferences screen.

To turn the mobile radio on or off:

- Tap the Mobile pick list and select On or Off.

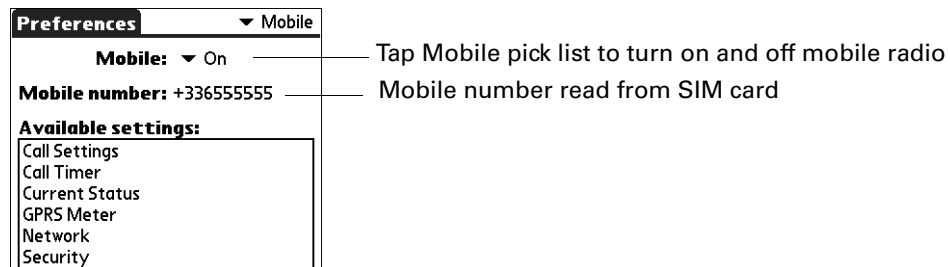

Enabling call waiting

NOTE Call waiting is a subscriber service that may be provided by your wireless service provider. Contact your wireless service provider for information.

Call waiting lets you accept an incoming call when you have a currently active call. You are notified of the incoming call by a sound and a dialog box.

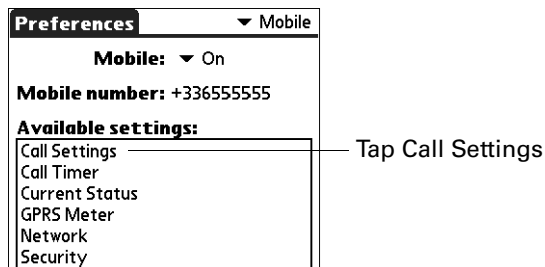

To enable or disable call waiting:

1. Tap Call Settings.

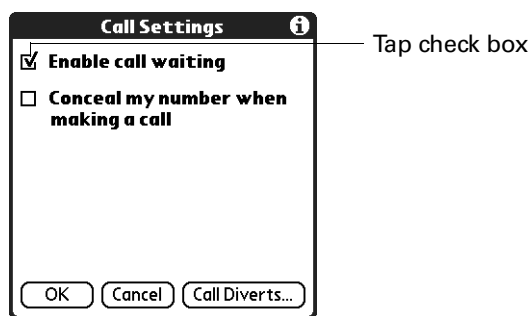

2. Tap the Enable call waiting check box to select or deselect it.



3. Press Function  + Enter , or tap OK.

Concealing your number

You can conceal (block) or display your number when making a call.

To conceal or display your number:

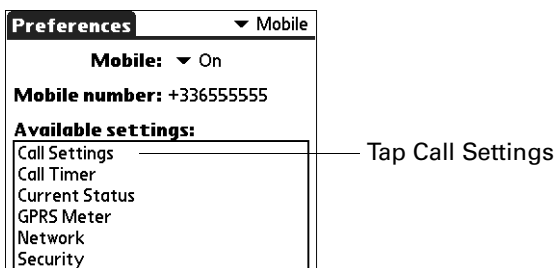

1. Tap Call Settings.

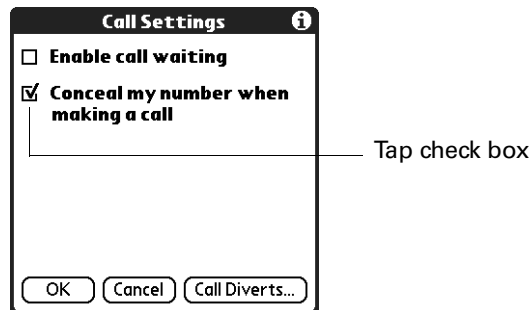

2. Tap the Conceal my number when making a call check box.

A checkmark appears, indicating that your number is concealed from the recipient when you place a call. Leave the check box blank to display your number to the recipient when you place a call.



3. Press Function  + Enter , or tap OK.

Diverting your calls

You can divert (forward) your phone calls, e-mail messages, and faxes to different numbers.

To divert your phone calls:

1. Tap Call Settings.

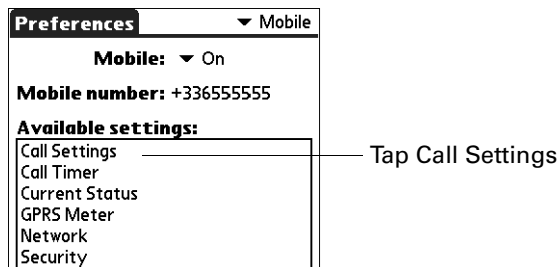

2. Tap Call Diverts.

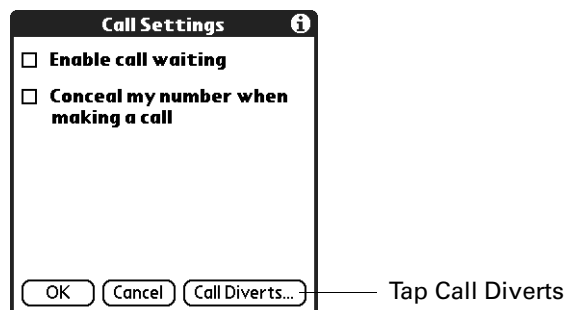

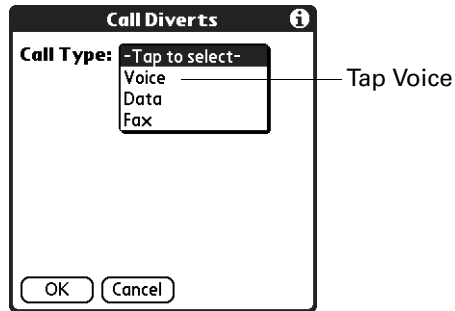

3. Tap the Call Type pick list and select Voice.

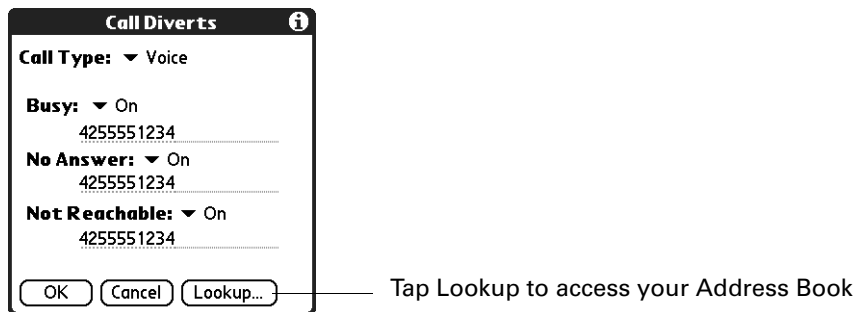

4. Tap a selection and select On.



- Busy** If the line is busy, diverts call to phone number.
- No Answer** If the call is not answered, diverts call to phone number.
- Not Reachable** If the mobile radio is out of range, diverts call to phone number.

5. Enter a phone number for the selection.
6. Press Function  + Enter , or tap OK.

To divert your e-mail:

1. Tap Call Settings.

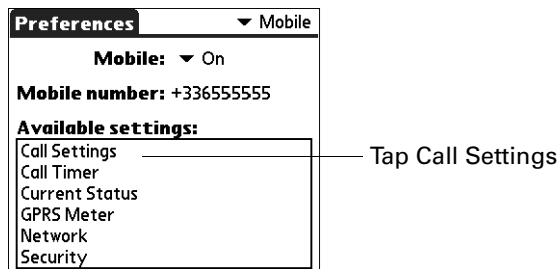

2. Tap Call Diverts.

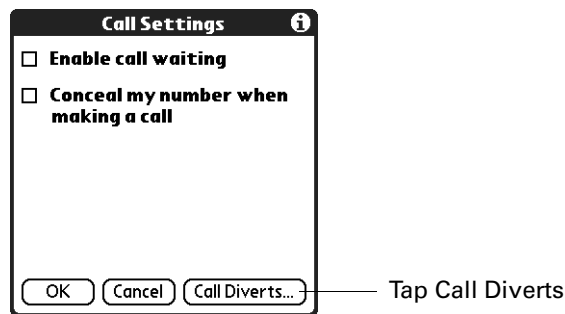

3. Tap the Call Type pick list and select Data.

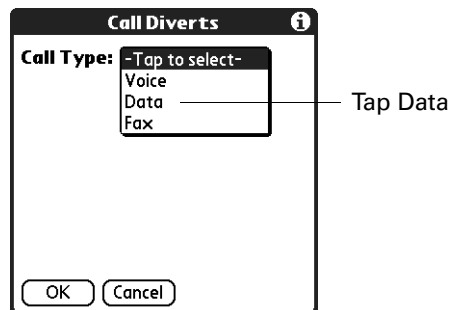

4. Tap the Data pick list and select On.

5. Enter the number.

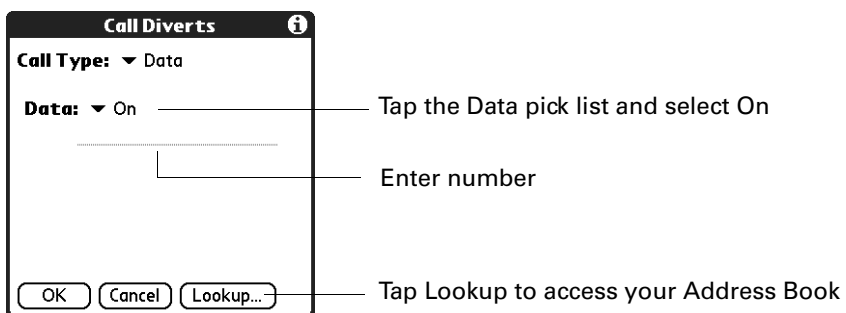

To divert your Fax messages:

1. Tap Call Settings.

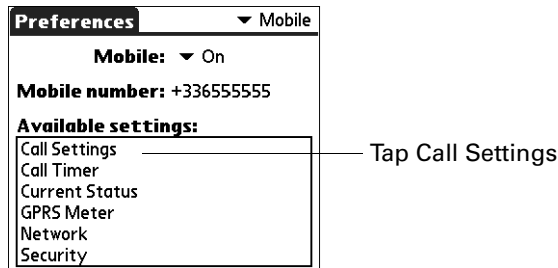

2. Tap Call Diverts.

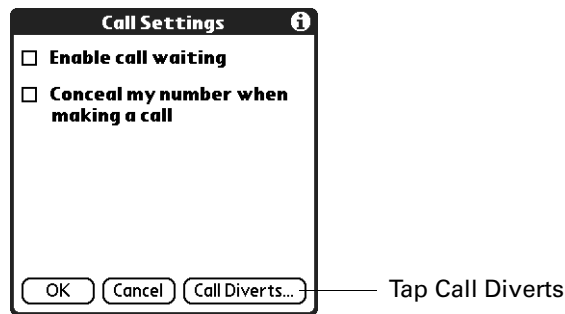

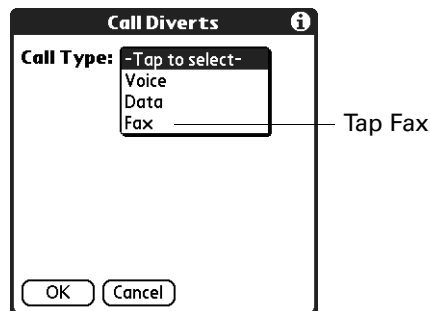

3. Tap the Call Type pick list and select Data.

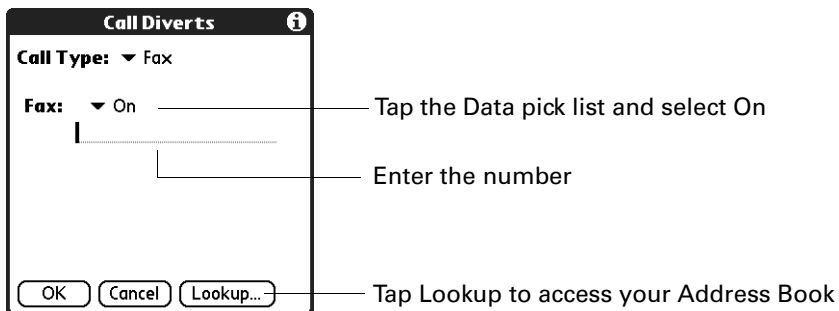

4. Tap the Fax pick list and select On.

5. Enter the number.



6. Press Function  + Enter , or tap OK.

Tracking your phone time

You can track your phone usage using the Call Timer screen.

To check your phone call timer settings:

1. Tap Call Timer.

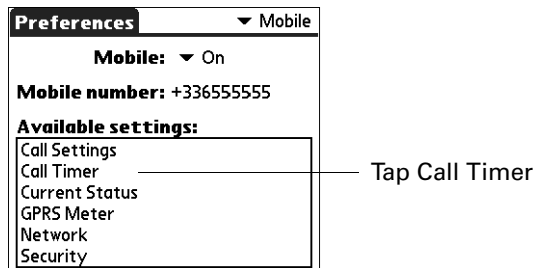

2. Check your phone usage statistics.

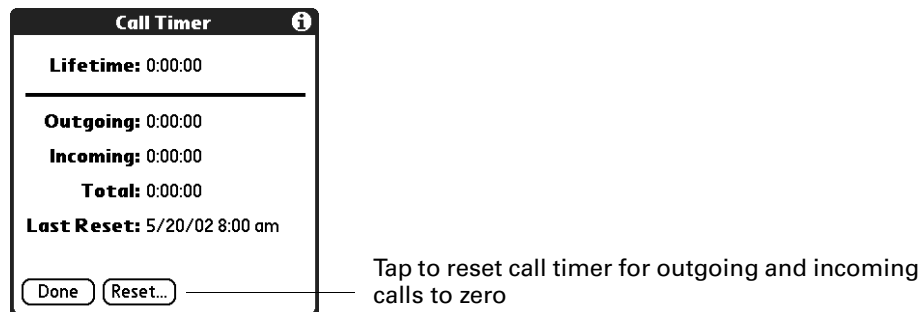

Check the following statistics:

Lifetime	Total amount of time spent on calls for the life of your mobile (it cannot be reset)
Outgoing	Amount of time spent on outgoing calls since last reset
Incoming	Amount of time spent on incoming calls since last reset
Total	Total amount of time spent on outgoing and incoming calls since last reset
Last Reset	Date and time you last reset the call timer to zero

Checking your current status

You can check your current status related to your handheld and network access.

To check your current status statistics:

1. Tap Current Status.

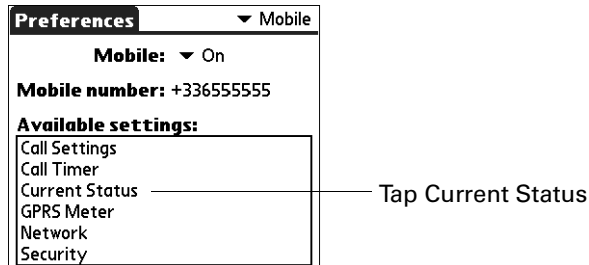

2. Check your current status statistics.

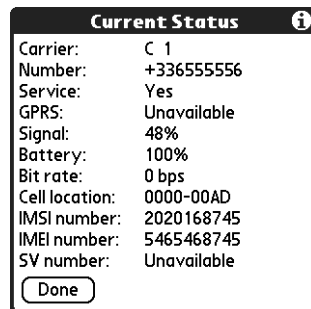

Check the following statistics:

Carrier	Name of your mobile carrier
Number	Your mobile phone number
Service	Indicates if voice service is available
GPRS	Indicates the current status of your GPRS data service
Signal	Percentage of signal strength
Battery	Percentage of battery strength remaining
Bit rate	Throughput rate measured in bits-per-second
Cell location	Cell location and tower assigned to your mobile
IMSI number	International Mobile Subscriber Identity assigned to your SIM card
IMEI number	Your mobile International Mobile Equipment Identity number
SV number	Your mobile Software Version number

Checking your GPRS network usage

You can check your GPRS network usage.

To check your GPRS network usage:

1. Tap GPRS Meter.

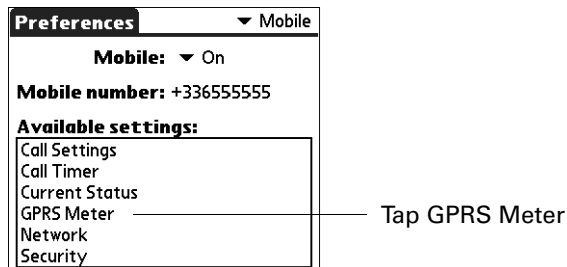

2. Check your current GPRS statistics.

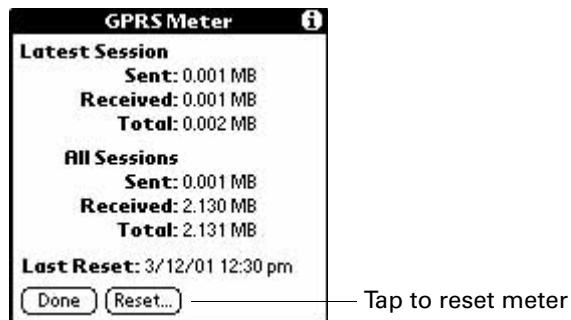

Check the following statistics:

Latest Session	Amount of information tracked (sent, received, and total) during your latest or current session since last reset
All Sessions	Amount of information tracked (sent, received, and total) on all sessions since last reset
Last Reset	Date and time of last reset

Setting your network selection search mode

The Search mode setting allows you to specify how the phone will register with a network carrier during mobile radio power-on. The following two options are available:

- Automatic** The phone attempts to register with the home network during mobile radio power-on. If the home network is not available, the phone automatically attempts to register with the next available network (if any). The phone attempts to register with each available network until registration succeeds or registration with each available network fails. The search order for network registration is home network, preferred carriers, and other carriers, respectively.
- Manual** The phone attempts to register with the home network during mobile radio power-on. If the home network is not available, a dialog box listing all the available networks is displayed for your selection.

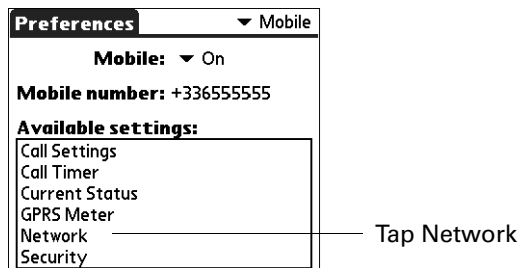

To set your network search mode:

1. Tap Network.

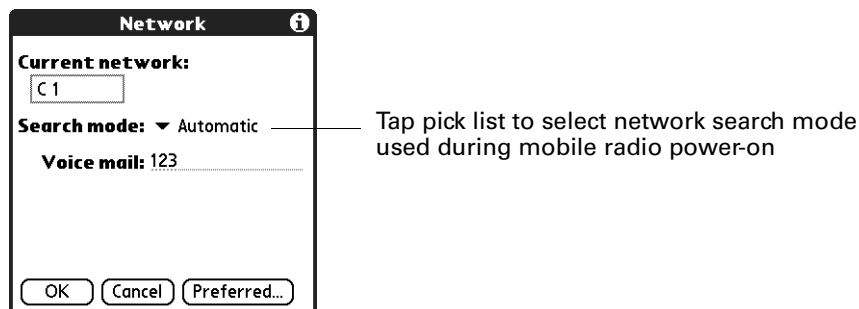

2. Tap the Search mode pick list and select Automatic or Manual.



3. Press Function  + Enter , or tap OK.

Viewing and editing your preferred networks list

If your home carrier is not available, your mobile registers with the next preferred network on your preferred networks list. You can view and edit your preferred networks. The networks are listed in order of priority, with the most preferred at the top. You can sort the priority list.

You can also add and remove networks. The user can add networks to the Preferred list by entering a new network ID or by selecting a network from the Known or Available lists. Networks are excluded from the Known and Available lists if they are already in the preferred list. This prevents duplicate networks from being added to the preferred list. Only one network can be added at a time.

IMPORTANT Some wireless service providers restrict editing privileges for the Preferred Networks list. If the list is restricted, you can read the list, but you are unable to edit it.

To view the Preferred Networks list:

1. Tap Network.

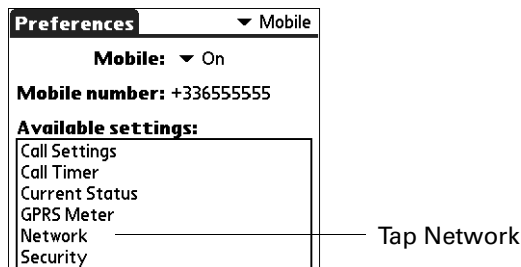

2. Tap Preferred.

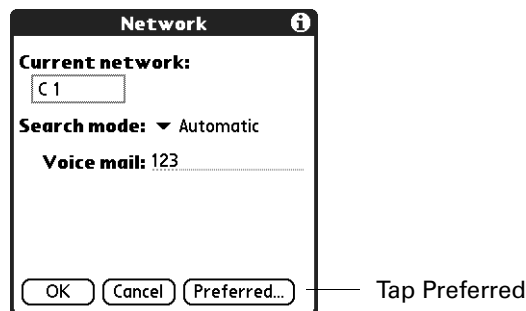

3. View the Preferred Networks list.

Networks are listed in order of priority, with the most preferred at the top.

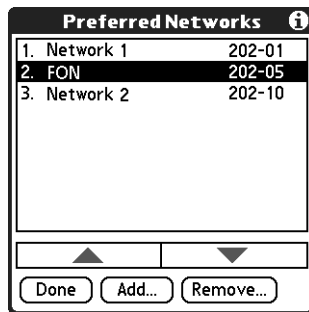

To sort priority in the Preferred Networks list:

- Select a network and tap the up or down arrow buttons.

To remove a network:

- Select a network and tap Remove.

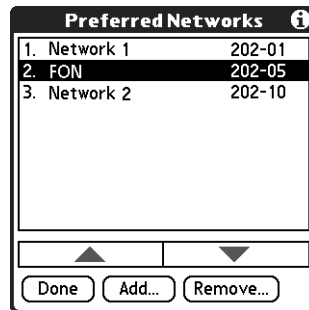

To add a network to the Preferred Networks list from your Known or Available Networks:

1. Tap Add.

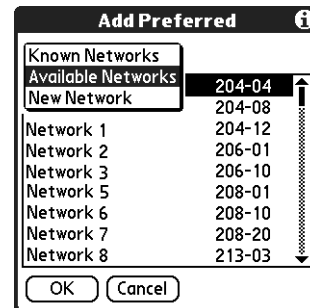
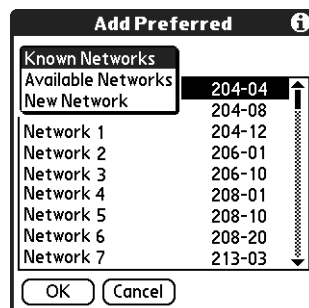

2. Tap the upper-left pick list and select Known Networks or Available Networks.



3. Select a network, and press Function  + Enter , or tap OK.

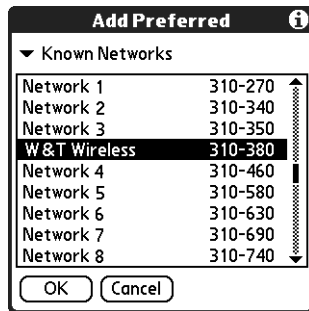

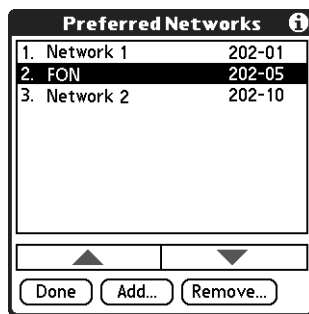

To add a network to the Preferred Networks list by specifying a network ID:

1. Tap Add.

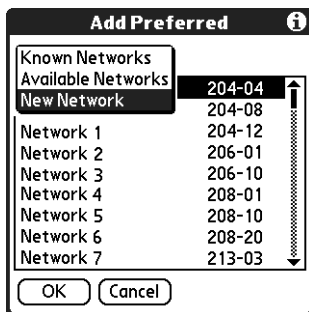

2. Tap the upper-left pick list and select New Network.



3. Enter the five- or six-digit network ID number, and then press Function  + Enter , or tap OK.

If you don't know the ID, contact the new network (mobile carrier).

The added networks appear at the bottom of your Preferred Networks list, where you can sort them.

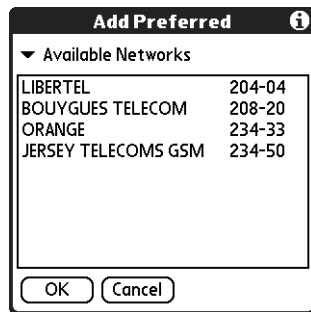

Setting PIN for mobile power on

When the Security setting is enabled, the mobile requires the user to enter a valid PIN code each time the mobile radio is powered on. The mobile is locked until a valid PIN code is entered. Modification of this setting is PIN code protected. You are prompted to enter a valid PIN code when a change to this setting is saved.

IMPORTANT If you enter the current PIN incorrectly three times, the SIM card is locked. You must enter an eight-digit PIN Unlock Key to unlock your SIM. See [“Unlocking your SIM card”](#) later in this chapter for more information.

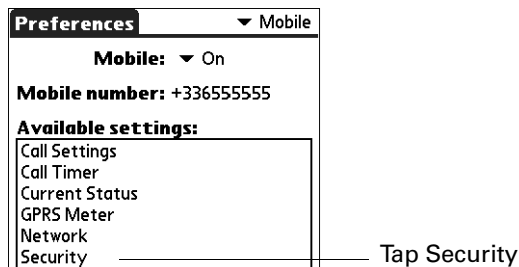

To edit PIN protection:

1. Tap Security.



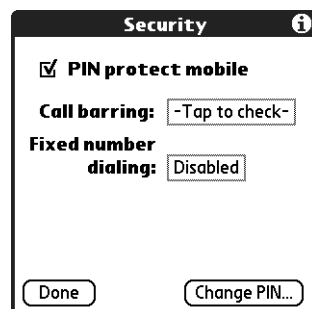

2. Tap the PIN protect mobile check box to select or deselect it.

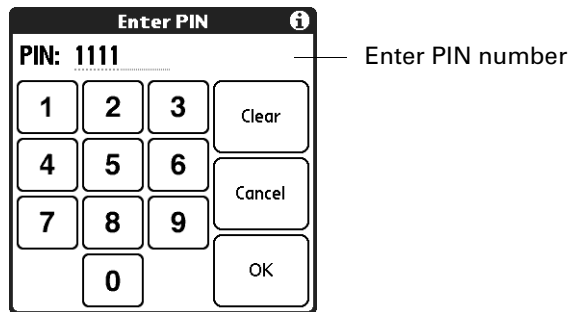

3. Enter a PIN number using the keypad and press Function  + Enter , or tap OK.

The minimum length is four characters, and the maximum length is eight characters.



4. Press Function  + Enter , or tap OK.

To change your PIN number:

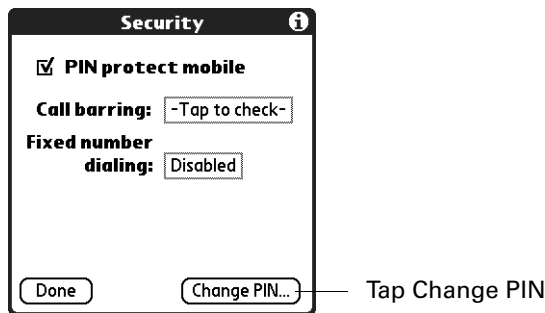

1. Tap Change PIN.



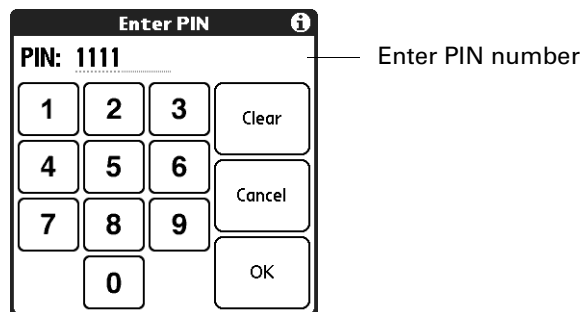

2. Enter your current PIN number.
3. Press Function  + Enter , or tap Done.

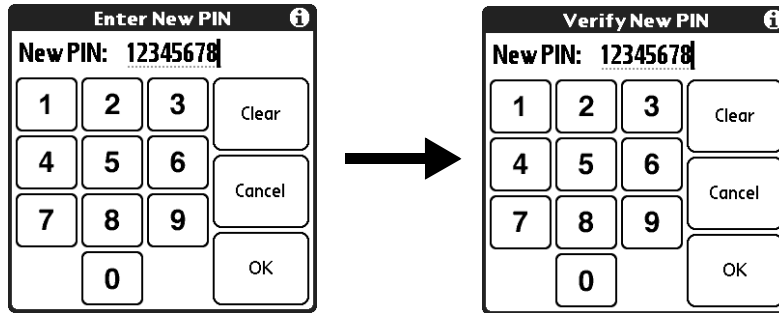

4. Enter a new PIN.

5. Press Function  + Enter , or tap OK.





6. Enter your new PIN number again to verify.
7. Press Function  + Enter , or tap OK.

Unlocking your SIM card

If you enter the current PIN incorrectly three times, the SIM card is locked. A SIM locked alert displays. You must enter an eight-digit PIN Unlock Key (PUK) to unlock your SIM. The PUK is provided by your wireless service provider. To find your PUK, check the documentation that came with your wireless service or contact your wireless service provider.

IMPORTANT If you enter your PUK incorrectly ten consecutive times, your SIM card is permanently locked. A permanently locked SIM card is usable for emergency dialing only. Contact your wireless service provider.



To unlock your SIM card:

1. Press Function  + Enter , or tap OK.



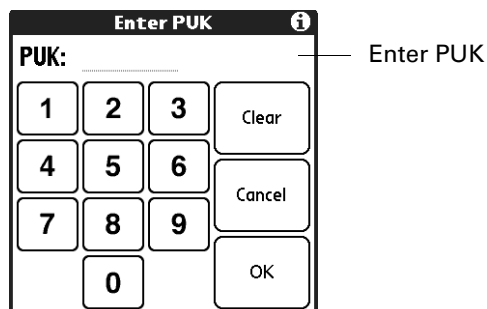

2. Enter your PUK.

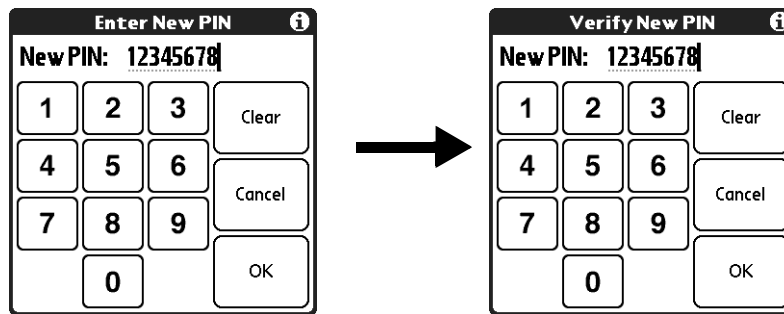

3. Enter a new PIN.
4. Press Function  + Enter , or tap OK.



5. Enter the new PIN again to verify.
6. Press Function  + Enter , or tap OK.

Setting call barring

Call barring is a supplementary service that allows you to bar or block different classes of incoming and outgoing calls ranging from All calls to No barring. The call barring settings are protected by the barring password. The barring password is managed by and originally obtained from the wireless service provider.

To edit call barring settings:

1. Tap Security.

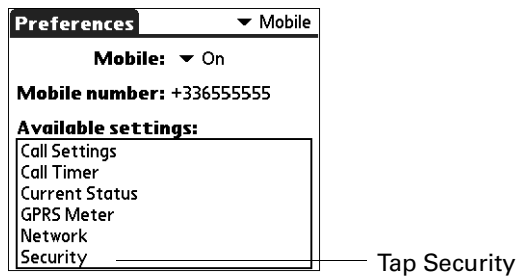

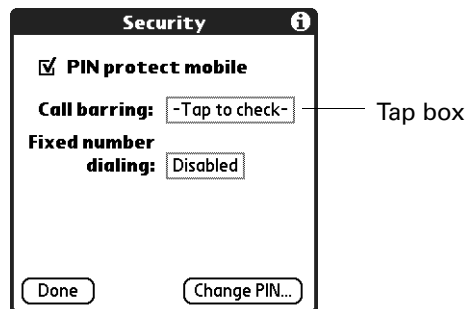

2. Tap the Call barring box.



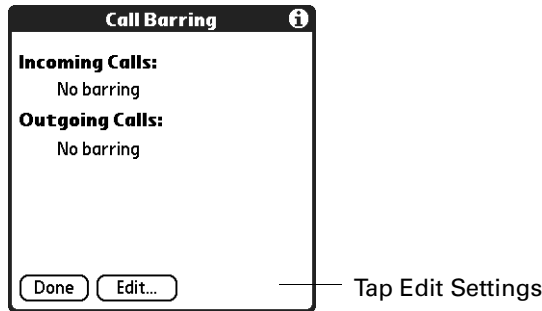

3. Tap Edit Settings.

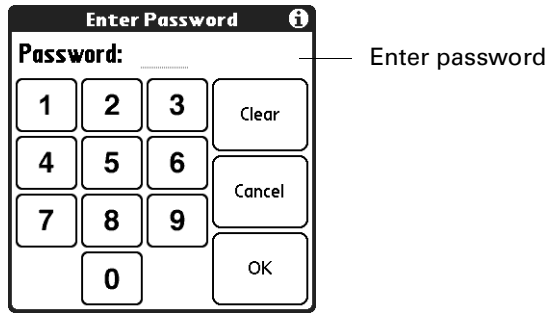

4. Enter a call barring four-digit password using the keypad.
5. Press Function  + Enter , or tap OK.



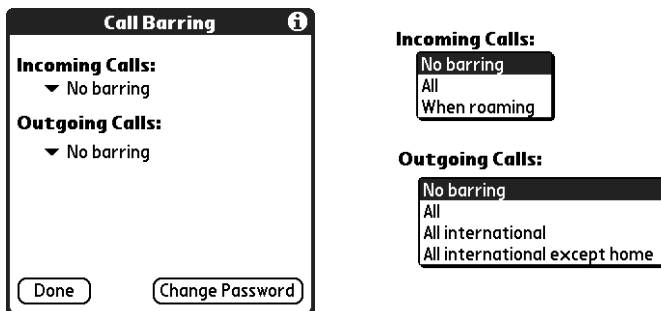

6. Tap the Incoming Calls or Outgoing Calls pick list to change settings.
7. Press Function  + Enter , or tap OK.



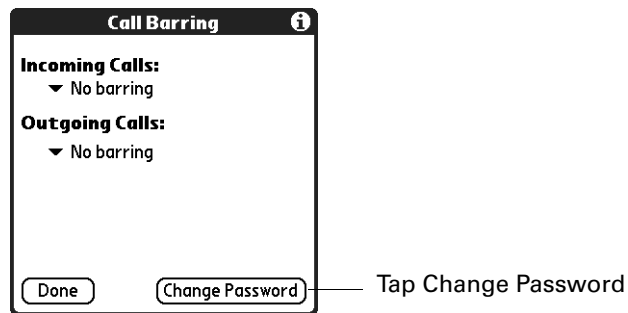

To change the call barring password:

1. Tap Change Password.

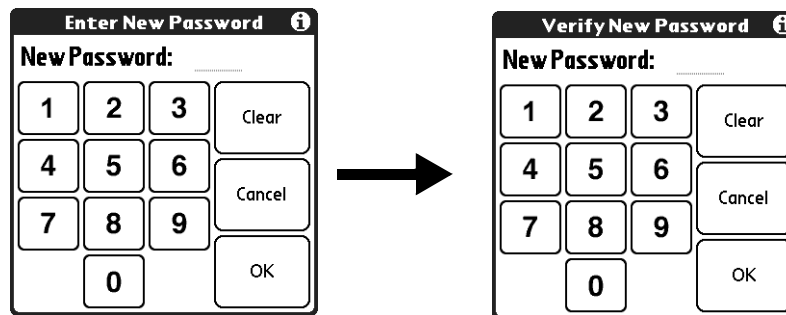

2. Enter a new four-digit password.
3. Press Function  + Enter , or tap OK.



4. Enter the new password again to verify.
5. Press Function  + Enter , or tap OK.

Setting Fixed Number Dialing (FND)

Fixed Number Dialing (FND) restricts the handheld so that only preprogrammed phone numbers in the FND phone book can be dialed.

There are two modes to the FND screen: view and edit. When the user taps the FND selector on the main Security screen, the FND view panel is displayed. You can view or dial the numbers that are stored in the FND phone book. Tapping Edit Settings and entering a valid PIN2 security code enables editing of the FND settings.

IMPORTANT If you enter the PIN2 code incorrectly three consecutive times, access to FND menus is blocked. You must obtain a PUK2 code from your wireless service provider to unlock the services.

When FND is enabled:

- Dialing is restricted to numbers contained in the FND phone book, except for emergency calls.
- You can extend an FND entry by adding digits to the dial string. This makes it possible to restrict dialing to a specific country or area code.

To view or dial an FND entry:

1. Select Security.

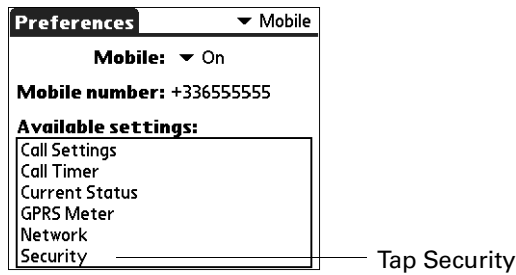

2. Select the Fixed dialing box.

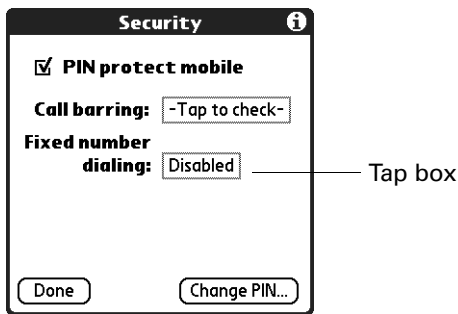

3. Select an entry and tap Dial.

You go to the Palm™ Mobile main screen and the number is dialed.

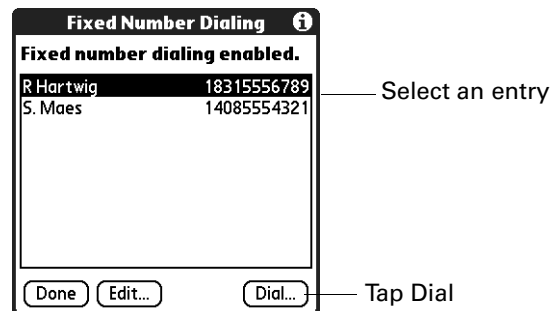

To add or edit an FND entry:

1. Select Edit.

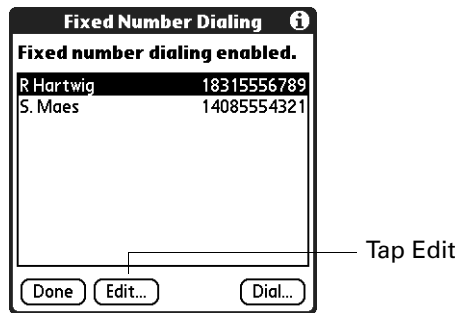

2. Enter your PIN2 number.
3. Press Function + Enter , or tap Done.

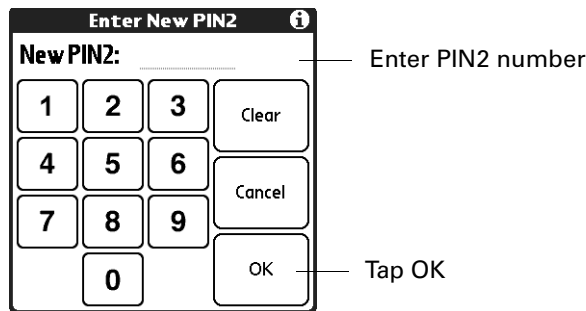

4. Tap New, or select an entry and tap Edit.

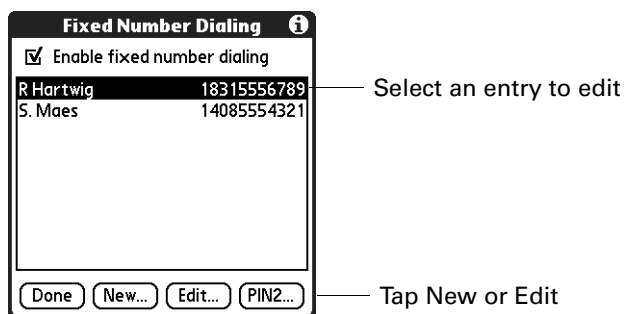

5. Edit or add the entry.
6. Press Function + Enter , or tap OK.

You can delete the entry by tapping Delete, or access your Address Book by tapping Lookup.

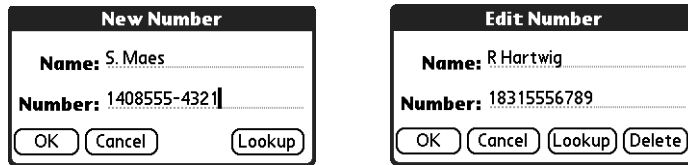

To change the PIN2 number:

1. Select Edit.

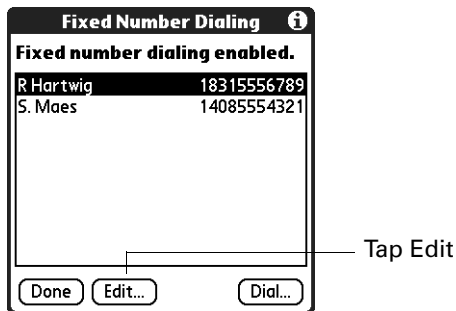

2. Enter your PIN2 number.
3. Press Function + Enter , or tap OK.

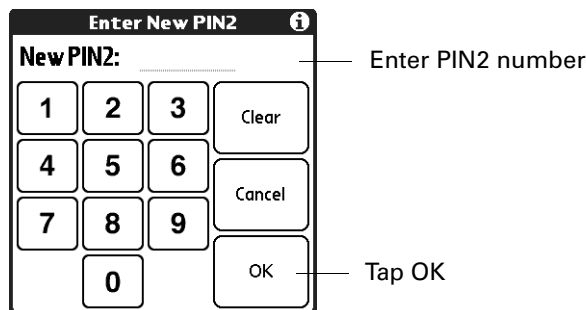

4. Tap PIN2.

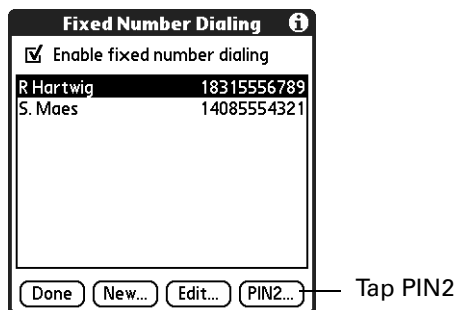



5. Enter the new PIN2 number.

6. Press Function  + Enter  or tap OK.

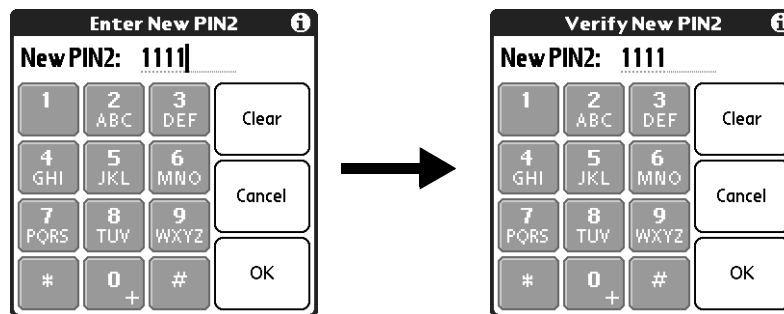
The number must be between four and eight digits.



7. Enter the new PIN2 number again to verify.
8. Press Function  + Enter , or tap OK.

Network preferences

Your handheld supports GPRS data connections and acts as a fully functional data modem for circuit-switched connections over GSM.

Modem Accessory and TCP/IP software

Although your handheld is wirelessly enabled, you can also use TCP/IP software that is included in the handheld operating system to connect with Internet Service Providers (ISPs) or dial-in (remote access) servers.

To use TCP/IP, you must create a configuration in Connection Preferences and then create Network Preferences settings.

The Connection Preferences screen enables you to define several ways that your handheld can use a modem to communicate with remote devices. For example, you can communicate with the wireless service provider server, or with your computer if you are traveling. See “[Connection preferences](#)” earlier in this chapter for a complete explanation of how to create modem configurations.

After you configure both the Connection and Network Preferences, you can establish a PPP (Point-to-Point Protocol) connection with your wireless service provider or dial-in server. You can do this either by using menu commands from the Network Preferences screen or by using a third-party application.

NOTE TCP/IP provides the ability to connect to your wireless service provider or dial-in server with applications that allow you to view the transmitted data. Visit the web site www.palm.com/support/intl for information on third-party applications that take advantage of TCP/IP.

Selecting a service

Use the Service setting to select the service template for your wireless service provider or a dial-in server. Service templates are a set of wireless service provider and dial-in server configuration settings that you can create, save, and reuse. Also, you can create new service templates. See [“Creating additional service templates”](#) later in this chapter.

To select a service:

1. Tap the Service pick list.

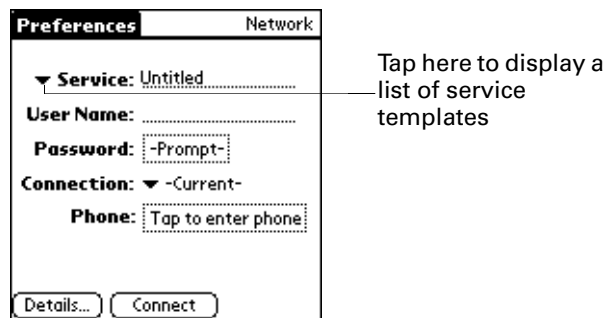

2. Select the predefined service template you want to use.

Entering a username

The User Name setting identifies the name you use when you log in to your wireless service provider or your dial-in server. Although this field can contain multiple lines of text, only two lines appear onscreen.

To enter a username:

1. Tap the User Name field.
2. Enter your username.

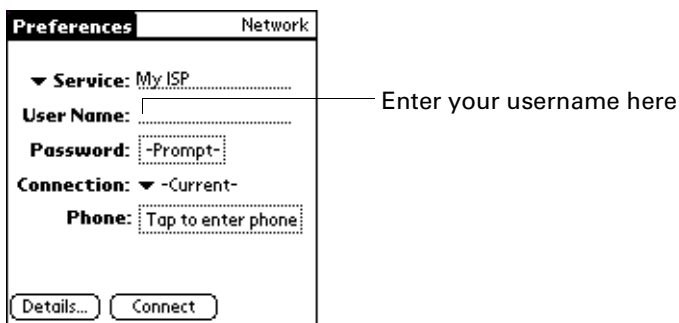

NOTE Most dial-in servers do not accept spaces in the username.

Entering a password

The Password box identifies the password you use to log in to your server or wireless service provider. Your entry in this field determines whether your handheld prompts you to enter a password each time you log in to your network:



- If you do not enter a password, your handheld displays the word “Prompt” in this field and asks you to enter a password during the login procedure.
- If you enter a password, your handheld displays the word “Assigned” in this field and does not prompt you to enter a password during the login procedure.

If you are concerned about security, select the Prompt option and do not enter a password.

To enter a password:

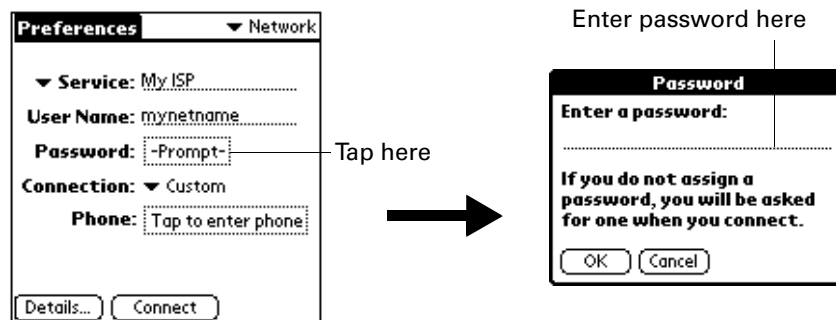
1. Tap the Password box.
2. Enter the password you use to log in to your server.



3. Press Function  + Enter , or tap OK.

The Password field updates to display the word “Assigned.”

Selecting a connection

Use the Connection setting to select the method you want to use to connect to your wireless service provider or a dial-in server. See “[Connection preferences](#)” earlier in this chapter for information about creating and configuring connection settings.

To select a connection:

1. Tap the Connection pick list.

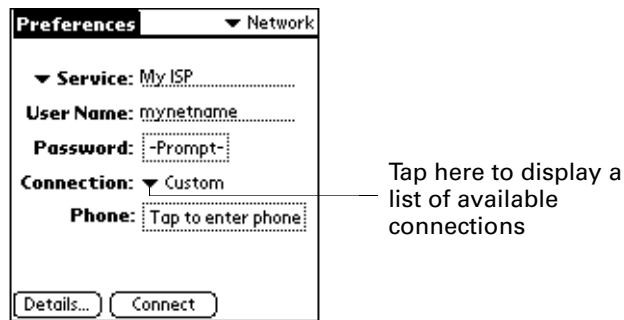

2. Select the connection you want to use.

Adding telephone settings

Some services require a telephone number. When you select the Phone field, a dialog box opens in which you define the telephone number you use to connect with your wireless service provider or dial-in server. In addition, you can define a prefix, disable call waiting, and give special instructions for using a calling card.

To enter your server phone number:

1. Tap the Phone field.
2. Enter the phone number for your wireless service provider or dial-in server.

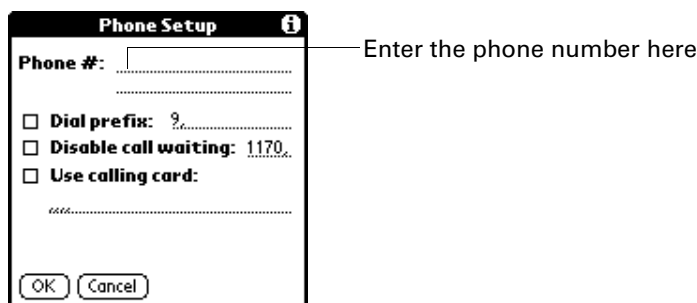

3. If you need to enter a prefix or disable call waiting, skip to those procedures. Otherwise, press Function  + Enter , or tap OK.



Entering a prefix

A prefix is a number that you dial before the telephone number to access an outside line. For example, many offices require that you dial “9” before dialing a number outside the building.

To enter a prefix:

1. Tap the Dial prefix check box to select it.



2. Enter the prefix.
3. Press Function  + Enter , or tap OK.

Disabling call waiting

Call waiting can cause your session to terminate if you receive a call while you are connected. If your telephone has call waiting, you need to disable this feature before logging in to your wireless service provider or dial-in server.

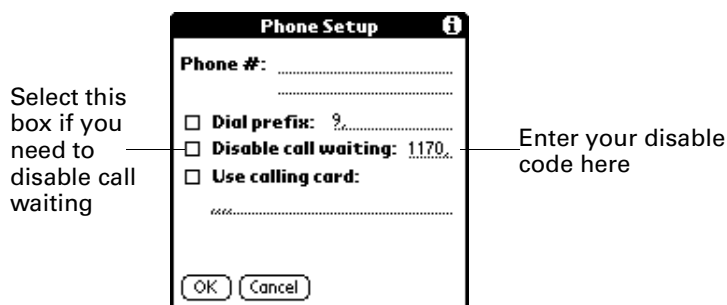

To disable call waiting:

1. Tap the Disable call waiting check box to select it.



2. Enter the code to disable call waiting on the Disable call waiting line.

Each telephone company assigns a code to disable call waiting. Contact your local telephone company for the code that is appropriate for you.

3. Press Function  + Enter , or tap OK.

Using a calling card

The Use calling card field enables you to use your calling card when dialing your wireless service provider or Intranet server. Keep in mind that there is usually a delay before you enter your calling card number. When you define your calling card number, you need to add commas at the beginning to compensate for this delay. Each comma delays transmission of your calling card number for two seconds.

To use a calling card:



1. Tap the Use calling card check box to select it.



2. Enter your calling card number on the Use calling card line.

NOTE The Phone Setup dialog box works correctly for AT&T and Sprint long-distance services. However, because MCI works differently, MCI customers need to put the calling card number in the Phone # field and the phone number in the Use calling card field.

TIP It's a good idea to add at least three commas before your calling card number to compensate for the cue delay.

3. Press Function  + Enter , or tap OK.

Connecting to your service

After you set your Connection and Network Preferences, establishing a connection to your wireless service provider or your company's network (dial-in server) is easy.

To establish a connection:

- Tap Connect to dial the current service and display the Service Connection Progress messages.

To see expanded Service Connection Progress messages, press the lower half of the Scroll button.

To close a connection:

- Tap Disconnect to terminate the connection between your handheld and your service.

Creating additional service templates

You can create additional service templates from scratch, or you can duplicate existing templates and editing information. After you create a new or duplicate template, you can add and edit settings.

To add a new service template:



- Press Command Stroke  + N.

Alternately, press Function  + Menu , and then select New on the Service Menu.

An Untitled service template is added to the Service pick list.

To duplicate an existing service template:

1. Tap the Service pick list.
2. Select the predefined service template you want to duplicate.
3. Press Command Stroke  + L.

Alternately, press Function  + Menu , and then select Duplicate on the Service Menu.

A copy of the service template is added to the Service pick list.

Adding detailed information to a service template

If you are using one of the predefined service templates, you probably need to enter only your username and telephone number. If you are creating a new service template, you may need to provide additional information to your wireless service provider or dial-in server. You use the Details dialog box to add more information to a selected service template.

To add connection details:

1. Tap the service field.
2. Tap Details.

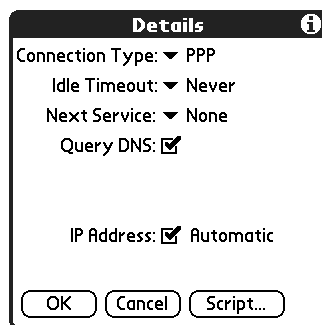

Idle timeout



The Idle timeout setting defines how long your handheld waits before dropping the connection with your wireless service provider or dial-in server when you switch out of a TCP/IP application.

To set the Idle timeout:

1. Tap the Idle timeout pick list and select one of the following options:

1 minute	Waits one minute for you to open another application before it drops the connection.
2 minutes	Waits two minutes.
3 minutes	Waits three minutes.
Never	Maintains your PPP or SLIP connection until you turn off your handheld (or until it times out).

CAUTION By enabling this option, you may incur significant charges if the connection to your wireless service provider is left open.

2. Press Function  + Enter , or tap OK.

Selecting Next Service

Next Service allows you to automatically try another connection method when the primary method fails. If the current connection fails, then a connection to the selected service is attempted. If you do not want to try another service connection, select None.

To select the Next Service:

- Tap the Next Service pick list and select a service.

Defining primary and secondary DNS

The Domain Naming System (DNS) is a mechanism in the Internet for translating the names of host computers into IP addresses. When you enter a DNS number (or IP address) you are identifying a specific server that handles the translation services.

Each IP address has four sections, separated by periods. In the Details dialog box, you enter each section separately. Each section of an IP address is made up of a number from 0 to 255; numbers are the only allowable characters in this field.

Ask your wireless service provider or system administrator for the correct primary or secondary DNS IP numbers.

Many systems do not require that you enter a DNS. If you are not sure, leave the DNS field blank.

To enter a primary and secondary DNS:

1. Tap the Query DNS check box to deselect it.

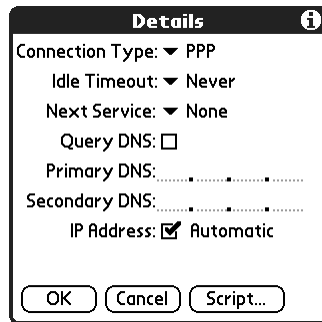

2. Tap the space to the left of the first period in the Primary DNS field, and then enter the first section of the IP address.
Each section must be a number from 0 to 255.
3. Repeat step 2 for the second, third, and last sections of the Primary DNS field.
4. Repeat steps 2 and 3 for the secondary DNS number.
5. Press Function + Enter , or tap OK.

IP address

Everyone who logs in to the Internet needs to have a unique identifier (an IP address), whether permanent or temporary. Some networks dynamically assign a temporary IP address when clients log in. The IP Address field lets you identify whether your network provides automatic (dynamic) temporary IP addressing.

If your IP address is permanently assigned, you need to get that information from your system administrator. If you are not sure, select Automatic.

To identify dynamic IP addressing:

- Tap the IP Address check box to select it.

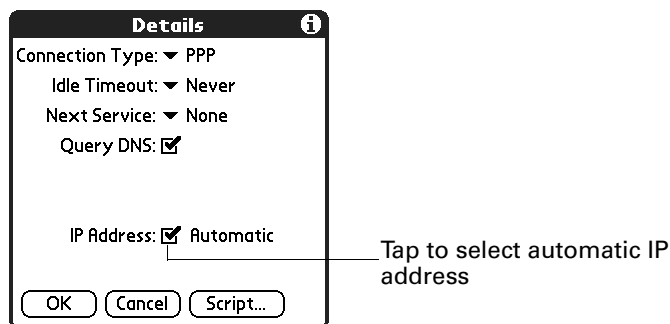

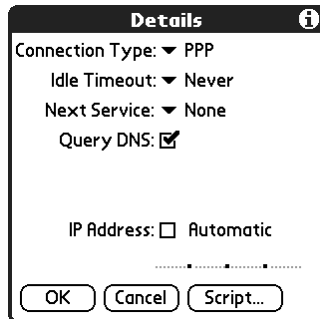

To enter a permanent IP address:

1. Tap the IP Address check box to deselect it and display a permanent IP address field below the check box.



2. Tap the space to the left of the first period, and then enter the first section of the IP address.

Each section must be a number from 0 to 255.

3. Tap and enter the remaining sections of the IP address.
4. Press Function  + Enter , or tap OK.

Login scripts

A login script is a series of commands that automates logging in to a network server—for example, your corporate network or your wireless service provider. A login script is associated with a specific service template created in Network Preferences.

A login script is something that you are likely to receive from your system administrator if your company has a system in which you log in to the corporate servers from your handheld using a modem or network connection. The script is generally prepared by the system administrator and distributed to users who need it. It automates the events that must take place in order to establish a connection between your handheld and the corporate servers.

You can create login scripts from the Login Script dialog box on your handheld, accessed from the Details dialog box in Network Preferences.

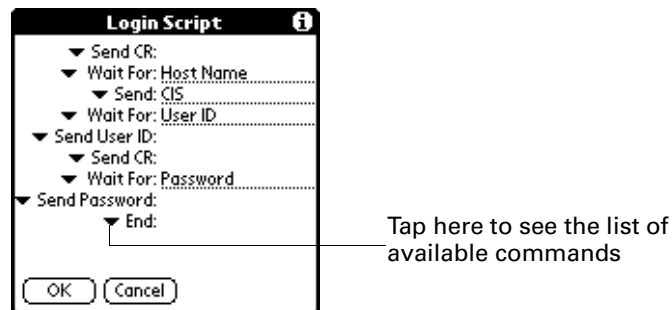

NOTE You can also use non-ASCII and literal characters in your login script.

Creating a login script on your handheld

You can create login scripts by selecting commands from the Command pick list in the Login Script dialog box. Some commands, such as Send, require you to supply additional information. Those commands have a parameter field so that you can add the necessary data.

To create a login script:

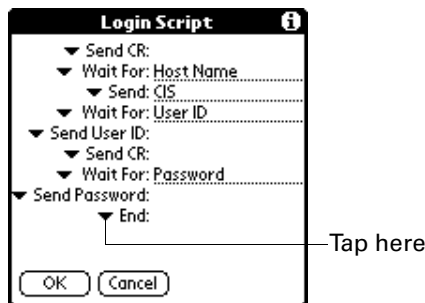

1. Tap Script.
2. Tap the End pick list.



3. Select the command you want from the Command list. If the command requires additional information, a field appears to the right of it for you to enter the information. The following commands are available:

Wait For	Tells your handheld to wait for specific characters from the TCP/IP server before executing the next command.
Wait For Prompt	Detects a challenge-response prompt coming from the server and then displays the dynamically generated challenge value. You then enter the challenge value into your token card, which in turn generates a response value for you to enter on your handheld. This command takes two arguments, separated by a vertical bar () on the input line.
Send	Transmits specific characters to the TCP/IP server to which you are connecting.
Send CR	Transmits a carriage return or LF character to the TCP/IP server to which you are connecting.
Send User ID	Transmits the user ID information entered in the User ID field of the Network Preferences screen.
Send Password	Transmits the password entered in the Password field of the Network Preferences screen. If you did not enter a password, this command prompts you to enter one. The Password command is usually followed by a Send CR command.

Delay	Tells your handheld to wait a specific number of seconds before executing the next command in the login script.
Get IP	Reads an IP address and uses it as the IP address for your handheld. This command is used with SLIP connections.
Prompt	Opens a dialog box and prompts you to enter text of some kind (for example, a password or a security code).
End	Identifies the last line in the login script.

- Repeat steps 2 and 3 until the login script is complete.
- Press Function  + Enter , or tap OK.

Plug-in applications

You can create plug-in applications containing script commands that extend the functionality of the built-in script commands. A plug-in application is a standard PRC application that you install on your handheld just like any other application. After you install the plug-in application, you can use the new script commands in a login script.

Plug-in applications have the following characteristics:

- Written in C language
- Compiled into a device executable
- Called properly from a login script
- Able to return control to a login script after it terminates
- Created using a development environment that supports Palm OS® software, such as Metrowerks CodeWarrior for Palm Platform.





For additional information on creating plug-in applications, send e-mail to Palm Developer Support at devsupp@palm.com.

Deleting a service template

There is only one way to delete a service template: use the Delete command from the Service menu.

To delete a service template:

- Tap the Service pick list.
- Select the service template you want to delete.

3. Press Command Stroke  + D.
Alternately, press Function  + Menu , and then select Delete on the Service Menu.
4. Press Function  + Enter , or tap OK.

Network preferences menu commands

The Network Preferences screen includes menu commands to make it fast and easy to create and edit service templates. See “Using menus” in [Chapter 4](#) for more information about choosing menu commands.

Service menu

Service	Edit	Options
New	<input checked="" type="checkbox"/>	N
Delete...	<input checked="" type="checkbox"/>	D
Duplicate	<input checked="" type="checkbox"/>	L

Options menu

Service	Edit	Options
		View Log <input checked="" type="checkbox"/>

View Log

The Network Log lists all of the communication that occurs between your modem and your dial-in server during the login procedure. The information in the Network Log can help your wireless service provider or your system administrator pinpoint where the login procedure communication fails and why.

Owner preferences

The Owner Preferences screen enables you to record a name, company name, phone number, or any other information that you want to associate with your handheld. This information can be from the business card created during installation.

If you use the Security Preferences screen to turn off and lock your handheld with a password, information that you put in the Owner Preferences is displayed the next time you turn on your handheld.



To enter the Owner preferences:

- Enter the text that you want to associate with your handheld in the Owner Preferences screen. If you enter more text than can fit on one screen, a scroll bar automatically appears on the right side of the screen.

The screenshot shows a screen titled "Preferences" with a dropdown menu set to "Owner". The screen contains several text input fields with the following text: "This handheld computer is owned by:", "Perry Smith", "555 Long Road", "Midtown, Nevada", "888-555-1212", and "If found, please contact me!".

If you assign a password with the Security Preferences screen, the information in the Owner Preferences screen cannot be changed. In this case, an Unlock button appears at the bottom of the screen.

To unlock the Owner Preferences screen:

1. Tap Unlock.
2. Enter the password that you defined in the Security Preferences screen.
3. Press Function  + Enter , or tap OK.

Security preferences

Your handheld comes with a Security feature so that unauthorized users cannot view the entries you wish to protect. Use the Security feature to do the following:

- Lock and turn off your handheld so that it does not operate until you enter the correct password.
- Mask all records that you mark as private so the information appears grayed out.
- Hide all records that you mark as private so they do not appear on any screen.

You can mask and hide private records with or without a password. Without a password, private records are hidden or masked until you set the Security preference to show them. With a password, you must enter the password to view the private entries.

Assigning a password

You can assign a password to protect your private records and to lock your handheld.



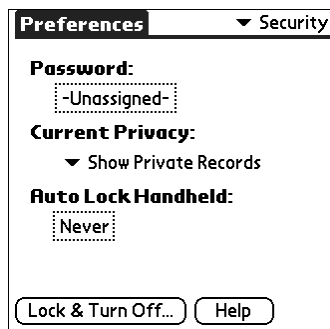

To assign a password:

1. Tap the Password box.

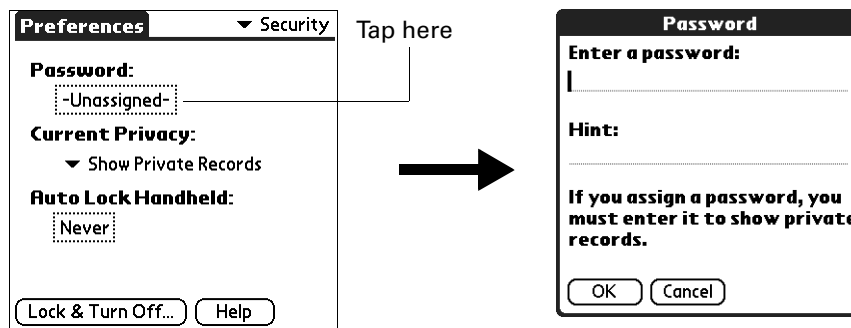

2. Enter a password.
3. Enter a hint to help your remember your password if you forget it. This is optional.



4. Press Function  + Enter , or tap OK.
5. Enter the *same* password a second time, and press Function  + Enter , or tap OK.



Changing or deleting a password

Once you define a password for your handheld, you can change or delete it at any time. You must enter the current password before you can change or delete it.

To change or delete your password:

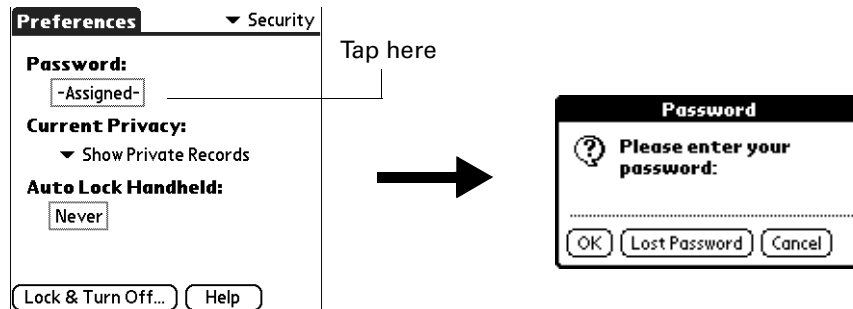
1. Tap the Password box.
2. Enter the current password.



3. Press Function + Enter , or tap OK.
4. Do one of the following:
 - To change the password and hint, enter the new password and hint, and press Function + Enter , or tap OK.
 - To remove the password, tap Unassign.



Locking your handheld

You can lock your handheld so that it cannot be operated until your password is entered. In the event that your handheld is lost or stolen, this helps protect your data from unauthorized use. You can set your handheld to lock automatically, or you can lock it manually.

NOTE The lockout screen has an Emergency Call button in case the phone needs to be used in an emergency.

Locking your handheld automatically

You can set your handheld to lock automatically when any one of the following occur:

- When you turn off the power
- At a time you specify
- After a period of inactivity you specify

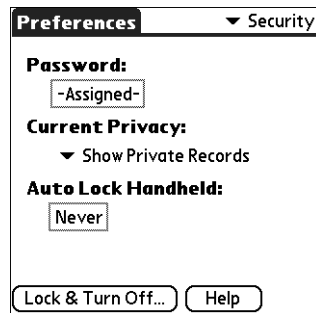

To set your handheld to lock when you turn it off:

1. Tap the Auto Lock Handheld box.



2. Enter your password.



3. Select On power off.
4. Press Function  + Enter , or tap OK.

To set your handheld to lock at a preset time:

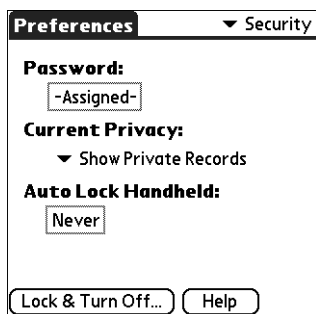

1. Tap the Auto Lock Handheld box.

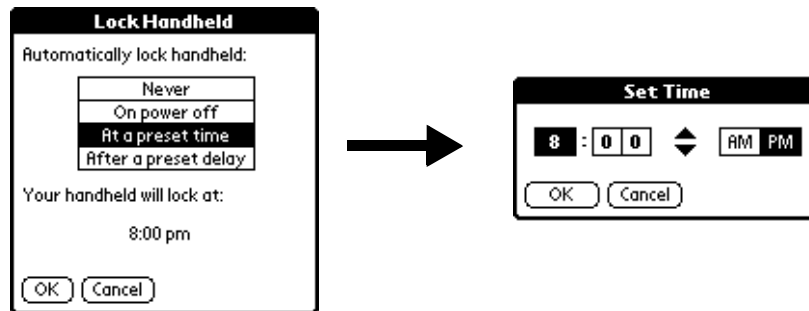

2. Enter your password.

3. Select At a preset time, and then use the arrows to set the time.



4. Press Function  + Enter , or tap OK.

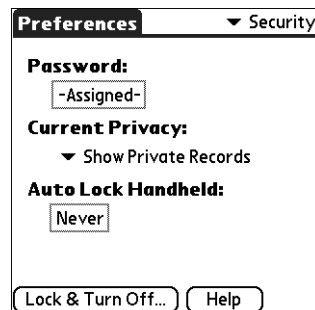

To set your handheld to lock after a period of inactivity:

1. Tap the Auto Lock Handheld box.

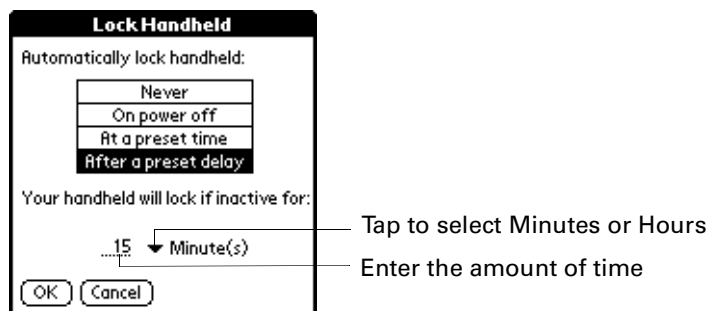

2. Enter your password.
3. Select After a preset delay.



4. Enter the inactive period, and then select Minute(s) or Hour(s) from the pick list.
5. Press Function  + Enter , or tap OK.

IMPORTANT If you lock your handheld, you must enter the exact password to reactivate your handheld. If you forget the password, your handheld will present the hint you have entered to help you remember the password. If you still cannot remember the password, you must perform a hard reset to resume using your handheld. Performing a hard reset deletes all the records in your handheld; however, you can restore all synchronized data at the next HotSync operation. See [“Performing a hard reset”](#) in [Appendix A](#) for more information.

Locking your handheld manually

You can turn off and lock your handheld manually. When the handheld is locked, you can only make emergency calls by pressing the four application buttons simultaneously.

To lock and turn off your handheld:

1. Tap Lock & Turn Off.

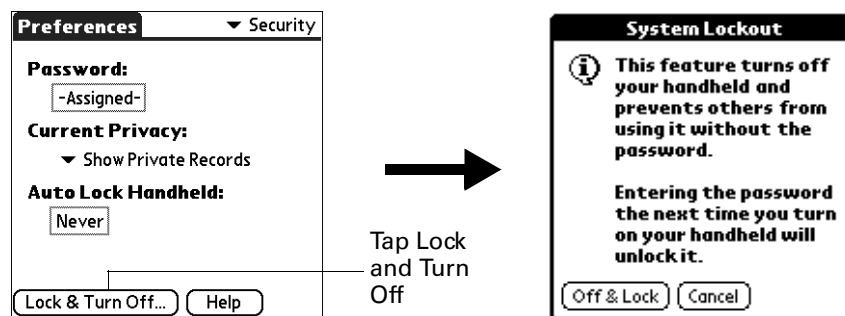

2. Tap Off & Lock.
3. To use your handheld, turn it on and then enter the password.



Recovering from a forgotten password

IMPORTANT Deleting a forgotten password also deletes all entries and files marked as Private.

If you forget your password, your handheld displays the password hint, if you entered one, to help you remember the password. If you are still unable to remember the password, you can delete it from your handheld.

IMPORTANT If you synchronize with your computer before deleting a forgotten password, your handheld restores your private entries the next time you perform a HotSync operation, but it does not restore the password.

To delete a forgotten password:

1. Tap Lost Password.
2. Press Function  + Enter , or tap Yes.

Making records private



In many applications, you can make individual records private. Private records remain visible and accessible, however, until you select the Security setting to hide or mask all private records. Masked records appear as grey placeholders in the same position they would appear if they were not masked, and are marked with a lock icon. Hidden records disappear completely from the screen. If you define a password for your handheld, you must enter it to display private records.

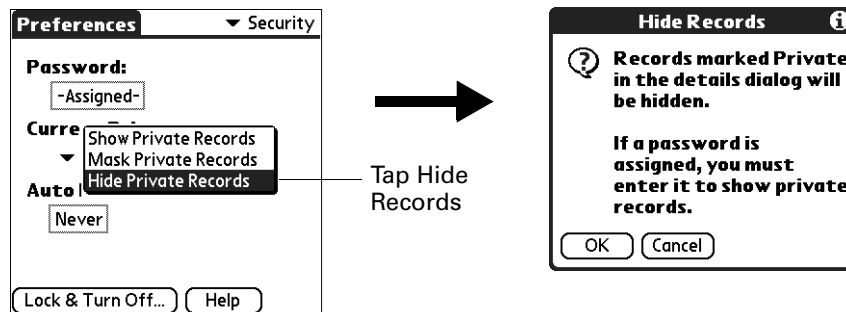

To hide all private records:

1. Tap the Current Privacy pick list and select Hide Records.





2. Press Function  + Enter , or tap OK to confirm that you want to hide private records.

To mask all private records:

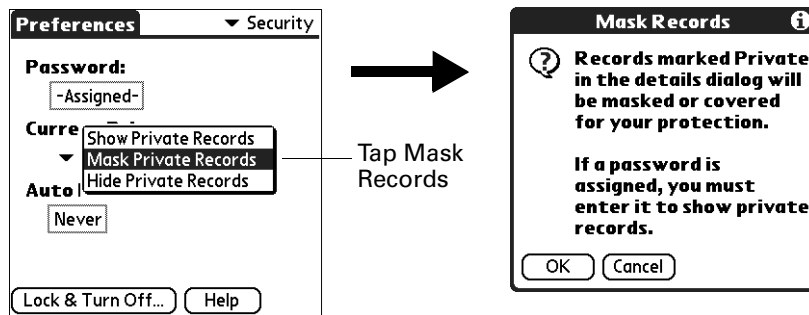
1. Tap the Current Privacy pick list and select Mask Records.





2. Press Function  + Enter , or tap OK to confirm that you want to mask private records.

To display all private records:

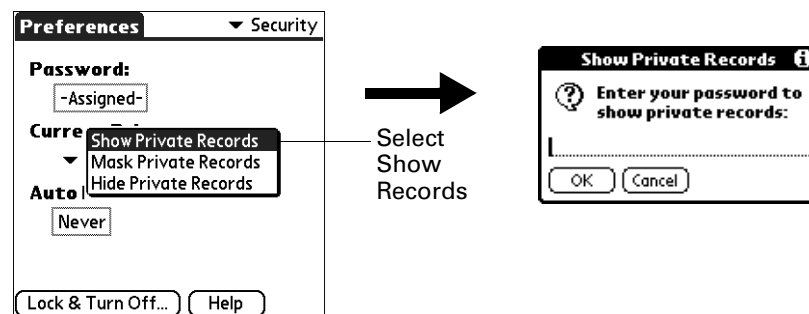

1. Do one of the following:

- Tap the Current Privacy pick list and select Show Records.
- If you do not have a password, hidden and masked records become visible. If you have a password, the Show Private Records dialog box appears. Go to step 2.



2. Enter your password.
3. Press Function  + Enter , or tap OK.

To unmask individual records:

1. Select a masked record.
2. Do one of the following:
 - If you do not have a password, a masked record becomes visible.
 - If you have a password, the Show Private Records dialog box appears. Go to step 3.
3. Enter your password.
4. Press Function  + Enter , or tap OK.

To make a record private:

1. Display the entry that you want to make private.
2. Tap Details.
3. Tap the Private check box.
4. Press Function + Enter , or tap OK.

ShortCuts preferences

The ShortCuts Preferences screen enables you to define abbreviations for entering text. This section describes how to create, edit, and delete a ShortCut.

Creating a ShortCut

You can create a ShortCut for any words, letters, or numbers. All ShortCuts you create appear on the list in the ShortCut Preferences screen. All the ShortCuts are available in any of your handheld applications and are backed up on your computer when you perform a HotSync operation.

To create a ShortCut:

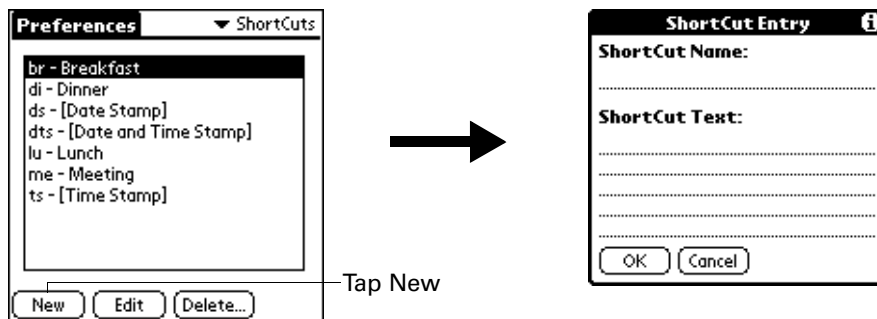

1. Tap New.
2. On the ShortCut Name line, enter the letters you want to use to activate the ShortCut.



3. Select the ShortCut Text area and enter the text that you want to appear when you write the ShortCut characters.

TIP You may want to add a space (space character) after the last word in your ShortCut text. This way, a space automatically follows the ShortCut text.

4. Press Function + Enter , or tap OK.

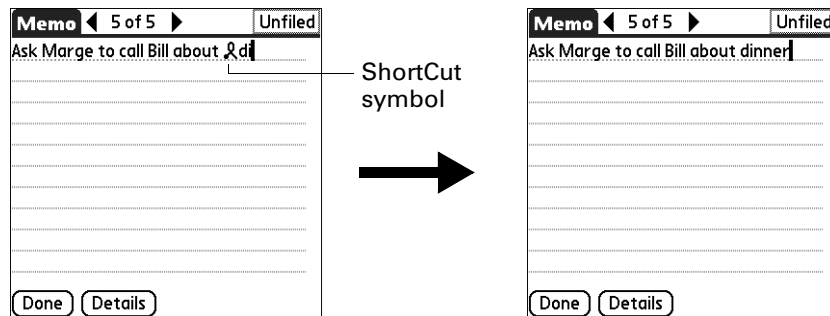

To use a ShortCut, press Press Function  + ShortCut  followed by the ShortCut characters. The ShortCut symbol appears at the insertion point to show that you are in ShortCut mode.



Editing a ShortCut

After you create a ShortCut, you can modify it at any time.



To edit a ShortCut:

1. Tap the ShortCut you want to edit.
2. Tap Edit.
3. Make the changes you want.
4. Press Function  + Enter , or tap OK.

Deleting a ShortCut

If you no longer need a ShortCut, you can delete it from the list of ShortCuts.

To delete a ShortCut:

1. Tap the ShortCut you want to delete.
2. Tap Delete.
3. Press Function  + Enter , or tap Yes.

Maintaining Your Handheld

This appendix provides information on the following:

- Proper care of your handheld
- Prolonging battery life
- Resetting your handheld
- Removing and installing your SIM card

Caring for your handheld

Your handheld is designed to be rugged and reliable and to provide years of trouble-free service. Please observe the following general tips when using your handheld:

- Take care not to scratch the screen of your handheld. Keep the screen clean. When working with your handheld, use the supplied stylus or plastic-tipped pens intended for use with a touch-sensitive screen. Never use an actual pen or pencil or other sharp object on the surface of the handheld screen.
- Your handheld is not waterproof and should not be exposed to rain or moisture. Under extreme conditions, water may enter the circuitry through the front panel buttons. In general, treat your handheld as you would a pocket calculator or other small electronic instrument.
- Take care not to drop your handheld or subject it to any strong impact. Do not carry your handheld in your back pocket: if you sit on it, you may damage it.
- Protect your handheld from temperature extremes. For example, do not leave your handheld on the dashboard of a car on a hot day or on a day when temperatures are below freezing, and keep it away from heaters and other heat sources.
- Do not store or use your handheld in any location that is extremely dusty, damp, or wet.
- Use a soft, damp cloth to clean your handheld. If the surface of the handheld screen becomes soiled, clean it with a soft cloth moistened with a diluted window-cleaning solution.

Battery considerations

Please note the following considerations for the battery in your handheld:

- Under normal conditions, you can keep your handheld battery charged by placing it in the cradle between 30 and 60 minutes each day. You can conserve battery life by minimizing the use of the backlight feature, and changing the Auto-off setting that automatically turns the handheld off after a period of inactivity. See “Auto-off delay” in [Chapter 21](#) for more information.
- If the battery becomes low in the course of normal use, an alert appears on the handheld screen describing the low battery condition. If this alert appears, perform a HotSync® operation to back up your data; then leave your handheld in the cradle to recharge the unit. This helps prevent accidental data loss.
- If the battery becomes too low, the wireless operations are disabled to save battery strength.
- If the battery drains to the point where your handheld does not operate, it stores your data safely for about five days. In this case, there is enough residual energy in the battery to store the data, but not enough to turn on your handheld. If your handheld does not turn on when you press the power button, you should recharge the unit immediately. The battery may not have enough residual energy to power the indicator light, which normally displays green when charging.
- If your battery drains and you have the unit in an uncharged state for an extended period of time, you can lose all of the stored data.
- There are no serviceable parts inside your handheld, so do not attempt to open the unit.
- If you ever dispose of your handheld, please dispose of it without damaging the environment. Take your handheld to your nearest environmental recycling center.

Resetting your handheld

Under normal circumstances, you will not have to use the reset button. On rare occasions, however, your handheld may no longer respond to buttons or the screen. In this case, you need to perform a reset to get your handheld running again.

Performing a soft reset

A soft reset tells your handheld to stop what it's doing and start over again. All records and entries stored in your handheld are retained with a soft reset. After a soft reset, the Welcome screen appears, followed by the Date and Time Preferences screen (to set date and time).

To perform a soft reset:

- Use the reset tip tool, or the tip of an unfolded paper clip (or similar object *without* a sharp tip), to gently press the reset button inside the hole on the back panel of your handheld.

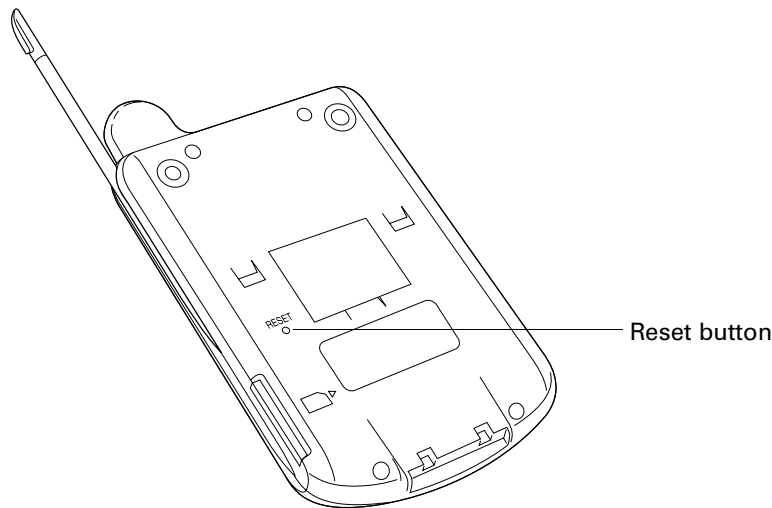

TIP The metal and plastic stylus that comes with your handheld has a reset tip inside. To use it, unscrew the barrel from the stylus quill.

Performing a hard reset

With a hard reset, all records and entries stored in your handheld are erased. Never perform a hard reset unless a soft reset does not solve your problem.

NOTE You can restore any data previously synchronized with your computer during the next HotSync operation.

To perform a hard reset:

1. Hold down the power button on the front panel of the handheld.
2. While holding down the power button, use the reset tip tool, or the tip of an unfolded paper clip (or similar object *without* a sharp tip), to gently press and release the reset button.

3. Wait for the Palm Powered™ logo to appear; then release the power button.
4. When a message appears on the handheld screen warning that you are about to erase all the data stored on your handheld, do one of the following:
 - Press Up on the navigator to complete the hard reset and display the Digitizer screen.
 - Press any application button to perform a soft reset. (Pressing a keyboard key has no effect.)

NOTE With a hard reset, the current date and time are retained. Formats Preferences and other settings are restored to their factory default settings.

To restore your data from a Windows computer after a hard reset:

1. Click the HotSync icon ™ in the Windows system tray (lower-right corner of the taskbar).

You can also click the HotSync command on the Palm™ Desktop software menu bar.

2. From the HotSync Manager menu, select Custom.
3. Select the appropriate username from the list.
4. Select an application in the Conduit list.
5. Click Change, and select Desktop overwrites the handheld.

Changing the HotSync setting from the default affects only the next HotSync operation. Thereafter, the HotSync Actions revert to their default settings. To use a new setting on an ongoing basis, select the Set As Default box. Thereafter, whatever you selected as the default setting is used when you click the Default button in the Custom dialog box.

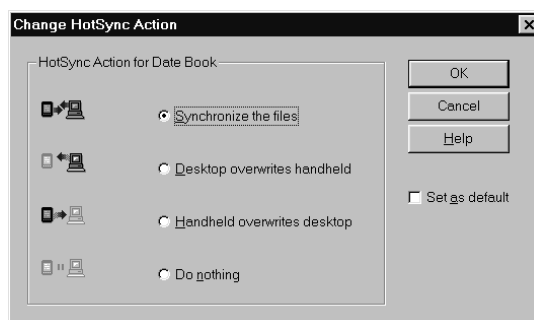

6. Click OK.
7. Repeat steps 4 through 6 to change conduit settings for other applications.
8. Click Done to activate your settings.
9. Perform a HotSync operation.

To restore your data from a Mac computer after a hard reset:

1. Double-click the HotSync Manager in the Palm folder.
2. From the HotSync menu, choose Conduit Settings.

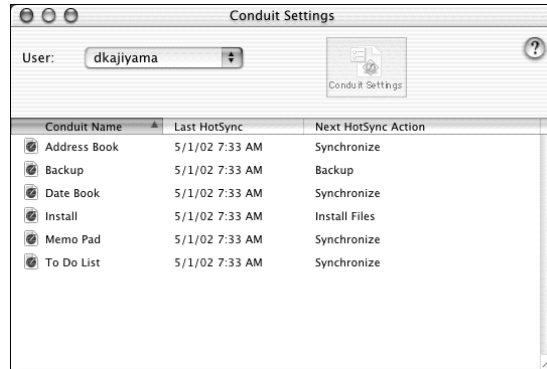

3. From the Users pop-up menu, select the appropriate username.
4. Select an application from the list.
5. Click Conduit Settings.

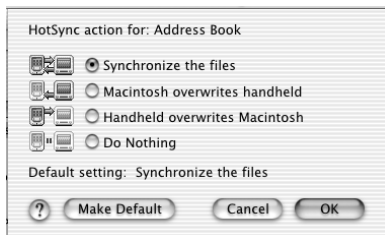

6. Click Macintosh overwrites handheld.

NOTE Changing the HotSync setting from the default affects only the *next* HotSync operation. Thereafter, the HotSync Actions revert to their default settings. To use a new setting on an ongoing basis, click Make Default. Thereafter, whatever you selected as the default setting is used for HotSync operations.

7. Click OK.
8. Repeat steps 4 through 7 to change conduit settings for other applications.
9. Close the Conduit Settings window.
10. Perform a HotSync operation.

Installing and removing the SIM card

With the SIM card installed, you can use your handheld's wireless features, such as the mobile phone, SMS, and wireless e-mail. Without the SIM card, you can operate your handheld, but you cannot use the wireless features.

If you have not installed your SIM Card, see the *Getting Started* that came with your handheld or use the following instructions. Most likely, the SIM card either is in your package or was handed to you by a representative of your wireless service provider. In some cases the SIM card is already installed in your handheld by your wireless service provider.

IMPORTANT If you are sending in your handheld for service to Palm, you must remove the SIM card before sending in your handheld. Use the following instructions if you need to exchange or remove the SIM card.

To install the SIM card or verify installation:

1. If you have the SIM card attached to its plastic holder, carefully detach the SIM card from the holder.
2. On the back panel of your handheld, slide a thin, flat edge (similar to your thumb nail) in the indent and under the access door until the access door is released.

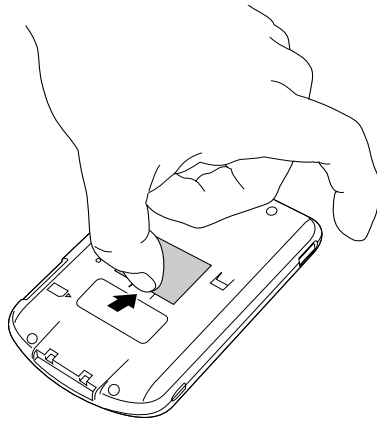

3. Do one of the following:

- If a placeholder card is present, remove the placeholder card. Then slide the SIM card into place on the access door. Close the access door.
- If the SIM card is present (look for the gold contact area), close the access door.

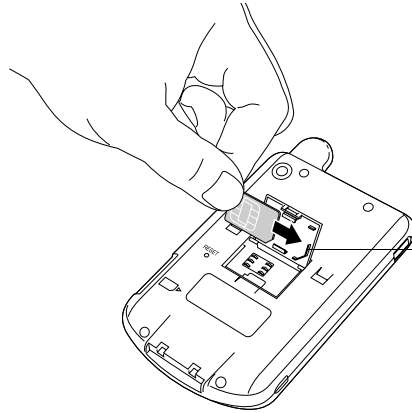

After removing the placeholder card, slide the SIM card into place on the access door

To remove the SIM card:

1. Turn off the handheld.

IMPORTANT Turn off the handheld before opening the access door and removing the SIM card. This prevents any static discharge and damage to the connector.

2. On the back panel of your handheld, slide your thumbnail into the indent and under the access door until the access door is released.

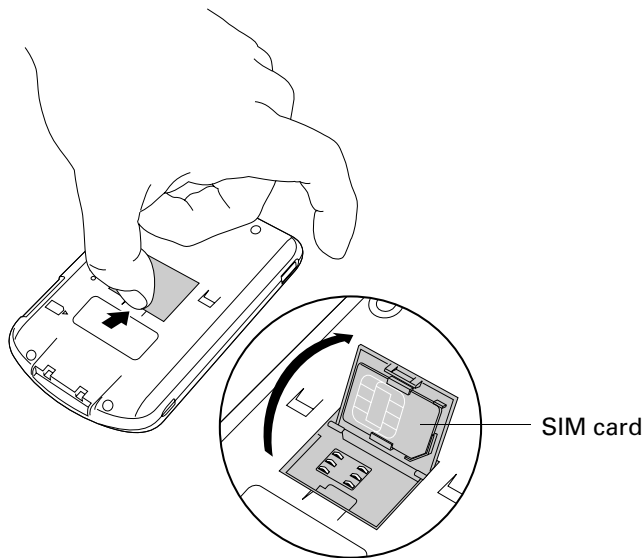

3. Slide the SIM card out of guides on the underside of the access door. Close the access door.

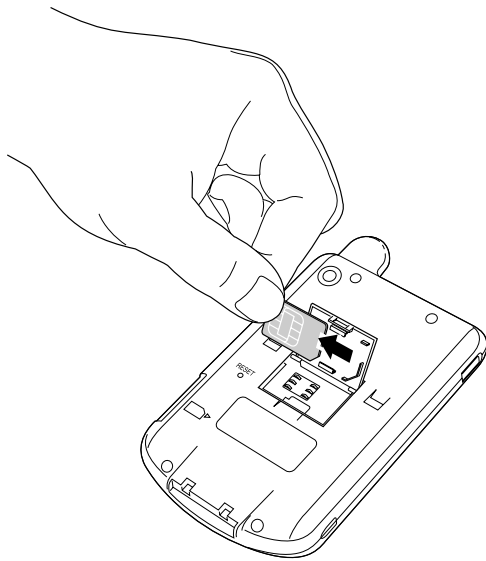

4. Place the SIM card in a nonstatic container for safe keeping.

Frequently Asked Questions

If you encounter a problem with your handheld, do not call technical support until you have reviewed the following list of frequently asked questions and you have also reviewed the following:

- This handbook
- The *Getting Started* that came with your handheld
- The README file located in the folder where you installed the Palm™ Desktop software on your Windows computer or on your installation CD for Macintosh users
- The Palm Desktop online Help
- The *Palm Desktop Software for the Macintosh User's Guide* located in the Documentation folder on your installation CD
- The Palm Knowledge Library, accessible at www.palm.com/support/intl under the Support section
- The most recent Palm™ Tungsten™ W handheld HelpNotes on your regional web site

If you are still having problems, contact Technical Support. See the Customer Support card that comes with your handheld, or go to www.palm.com/support/intl.

NOTE Thousands of third-party add-on applications have been written for Palm OS® handhelds. Unfortunately, we are not able to support such a large number of third-party applications. *If you are having a problem with a third-party application, please contact the developer or publisher of that software.*

Software installation problems

Problem	Solution
The Palm Desktop Installer Menu did not appear when I inserted the CD-ROM into my Windows computer.	<ol style="list-style-type: none">1. Click the Start button.2. Choose Run from the Start menu.3. Click Browse.4. Locate your CD-ROM drive and select the autorun.exe file.5. Click Open.6. Click OK.
I cannot install Palm Desktop software on my Windows computer.	<p>Try the following:</p> <ol style="list-style-type: none">1. Disable any virus scanning software on your computer.2. Press CTRL-ALT-DELETE and end all tasks except Systray and Explorer. If a dialog box with buttons appears instead of a list of tasks, click the Task List button and then end all tasks except Systray and Explorer.3. Make sure your computer has at least 30MB of disk space available.4. Delete all temporary files.5. Run ScanDisk on your computer.6. Reinstall Palm Desktop software.
I cannot install Palm Desktop software on a Mac computer.	<p>Try the following:</p> <ol style="list-style-type: none">1. Disable any virus-scanning software on your computer.2. Quit any open applications.3. Make sure your computer has at least 25MB of disk space available.4. Reinstall Palm Desktop software.



Operating problems

Problem

I don't see anything on my handheld's screen.

Solution

Try each of these in turn:

- Press an application button to ensure your handheld is turned on.
- Press Function  + Brightness . If the Brightness dialog box appears, adjust the brightness by holding down the up scroll button for a few seconds. If this doesn't work, hold the down scroll button for a few seconds.
- If your handheld was exposed to cold, make sure it is at room temperature.
- Recharge the unit.
- Perform a soft reset. If your handheld still doesn't turn on, perform a hard reset. See ["Resetting your handheld"](#) in [Appendix A](#).

IMPORTANT With a hard reset, all records and entries stored in your handheld are erased. Never perform a hard reset unless a soft reset does not solve your problem. You can restore any data previously synchronized with your computer during the next HotSync® operation.

My battery doesn't charge.



- Make sure the power outlet is active and the HotSync cradle is properly plugged in.
- If the battery does not hold a charge, return your handheld to an authorized Palm service center.

I get a warning message telling me my handheld memory is full.

- Purge records from Date Book and To Do List. This deletes To Do List items and past Date Book events from the memory of your handheld. See ["Purging records"](#) in [Chapter 4](#). You may need to perform a HotSync operation to recover the memory.
- Delete unused memos and records. If necessary, you can save these records. See ["Deleting records"](#) in [Chapter 4](#).
- If you have installed additional applications on your handheld, remove them to recover memory. See ["Removing applications"](#) in [Chapter 4](#).

My handheld keeps turning itself off.	Your handheld is designed to turn itself off after a period of inactivity. This period can be set at one, two, or three minutes. Check the Auto-off setting. See “Auto-off delay” in Chapter 21 .
My handheld is not making any sounds.	Check the System, Alarm, and Game Sound settings. See “System, alarm, and game sounds” in Chapter 21 .
My handheld’s indicator light is not blinking when alarms occur.	Check the Alarm LED setting. See “Alarm Vibrate and indicator light settings” in Chapter 21 .
My handheld does not vibrate when alarms occur.	Check the Alarm Vibrate setting. See “Alarm Vibrate and indicator light settings” in Chapter 21 .
My handheld has frozen.	Perform a soft reset. See “Resetting your handheld” in Appendix A .
My handheld appears to freeze when I place it near my computer.	Move your handheld away from the computer’s infrared port.

Tapping and writing problems

Problem	Solution
When I tap the buttons or screen icons, my handheld activates the wrong feature.	Calibrate the screen. See “Digitizer preferences” in Chapter 21 .
When I press Function  + Menu  , or tap the Menu bar nothing happens.	Not all applications or screens have menus. Try changing to a different application.

Wireless problems

Problem

The signal strength is weak.

Solution

You can monitor the transmission signal strength using the Signal Strength bar graph. Monitor the signal strength while you try the following solutions:

- Move away from your original location, five to ten feet in any direction.
- If you're indoors, stand near a window, or move outdoors.
- Open metal blinds on windows.
- If you're in an underground parking lot or other space below street level, move to a location above ground.
- If you're in a crowd, move to a less crowded area.
- If you're in a vehicle, keep your handheld level with the windshield. The metal frame of the vehicle shields mobile radio signals. Mountains and buildings may also block signals.
- If you're outdoors, move away from overhead electrical wires. Move from under trees.

I can't access the Internet.

- Check the battery icon to verify that the battery is charged.
- Make sure the mobile radio is on and within range by verifying that the indicator light is flashing green. See [“Using the indicator light”](#) in [Chapter 2](#).
- Verify that the signal strength indicator shows a strong signal.
- Your wireless service provider's server may be down. Try again later.

I can't access a web page or a web clipping application.

- Make sure the mobile radio is on and within range by verifying that the indicator light is flashing green. See [“Using the indicator light”](#) in [Chapter 2](#).
- Try to access the home page of your wireless carrier by pressing the Wireless button.
 - If you can access the home page, network service is available. It may be that the web page or the web clipping server currently is not accessible. Try again later.
 - If you cannot access the home page, network service may be down. Try again later.
- For questions and support for third-party web clipping applications, please contact the software developer directly.



I am having a problem establishing a network connection.

- Display expanded Service Connection Progress messages.

It's helpful to identify at what point in the login procedure the connection fails. An easy way to do this is to display the expanded Service Connection Progress messages. Expanded Service Connection Progress messages describe the current stage of the login procedure. Press Up on the navigator during login to display these messages.

- View the Network Log.

If viewing the expanded Service Connection Progress messages does not give you enough information to find out why you cannot connect to your wireless service provider or dial-in server, take a look at the Network Log. The Network Log lists all of the communication that occurs between your modem and your dial-in server during the login procedure. The information in the Network Log can help your wireless service provider or your system administrator pinpoint where the login procedure communication fails and why.

To view the Network Log, go to the Network Preferences screen and press Command Stroke  + V. (Alternately, press Function  + Menu . Select Options, and then select View Log.)

I am having a problem establishing a network connection. (continued)

- Add a DNS number.

If your wireless service provider or dial-in server requires a DNS number and you did not enter that information in the Network Preferences screen, it will appear that you successfully logged into your network. When you try to use an application or look up information, however, the connection fails. If this occurs, try adding a DNS number. Ask your wireless service provider or your system administrator for the correct primary and secondary DNS IP numbers.

Palm WAP Browser problems

Problem

Solution

I cannot connect to my wireless service provider.

You may need to enter additional technical networking information. Contact your wireless service provider to obtain their primary and secondary DNS address and their IP address.

I can connect to my ISP, but I can't access a WAP site.

Try alternate WAP sites. A WAP site could be temporarily unavailable due to site problems.

If you can't access the alternate sites, then contact your ISP and verify the following WAP browser settings: APN, Mode, and Gateway Server. Also check Gateway ID and Gateway password, if applicable.

I can't access some WAP sites.

The WAP browser can access all WAP web sites compliant to WAP version 1.1 or WAP version 1.2.1 (WAP June 2000 Conformance Release).

I can't access an HTML web site.

The WAP browser does not open HTML web sites, only WML web sites.

When generating a new password or signature key pair, my handheld froze.

Key generation can take up to an hour. During this time, your handheld appears to be completely frozen and you are not able to use your handheld.

I am having problems within a specific WAP Internet site.

Contact the site administrator.

SMS problems

Problem

I cannot connect to my SMS center.

Solution

You may need to enter the SMS center telephone number in the SMS Preferences Details dialog box. To find this number, check your mobile phone options screen or your wireless service provider's web site. See [“Setting preferences”](#) in [Chapter 15](#) for details.

Palm Mobile problems

Problem

I connect to my wireless service provider, but the number doesn't work.

Solution

- Be sure the telephone number you are dialing has all the digits required by your wireless service provider. If you are dialing an international telephone number, a + (plus) sign might be required at the beginning of the telephone number.
- Verify that your wireless service provider plan includes phone services. Contact your wireless service provider for information.

Application problems

Problem

I tapped the Today button, but it does not show the correct date.

Solution

Your handheld is not set to the current date. Make sure the Set Date box in the Date and Time Preferences screen displays the current date. See [“Date and Time preferences”](#) in [Chapter 21](#) for more information.

I know I entered some records, but they do not appear in the application.

- Check the Categories pick list (upper-right corner). Choose All to display all of the records for the application.
- Check Security and confirm that Private Records is set to Show private records.
- In To Do List, tap Show and see if Show Only Due Items is selected.

I am having problems listing memos the way I want to see them.

- If you cannot manually arrange the order of the memos in the list screen, check the Memo Preferences setting. Make sure that Sort by is set to Manual.
- If you choose to view your memos alphabetically on Palm Desktop software and then perform a HotSync operation, the memos on your handheld still appear in the order defined in the Memo Preferences setting. In other words, the sort settings you use with Palm Desktop software *are not* transferred to your handheld.

I created an event in Date Book, but it doesn't appear in the Week View.

In the Week View, you cannot select overlapping events that have the same start time. If you have two or more events with the same start time, choose the Day View to see the overlapping events.

My vCard or vCal e-mail attachment isn't forwarding correctly.

Palm Desktop software provides several features that interact with e-mail client software on a Windows computer. In order for these features to work correctly, the e-mail client software must be properly configured. Follow these steps to check the configuration:

1. Click the Windows Start menu, and then select Settings.
2. Select Control Panel.
3. Select Internet Options, and then click the Programs tab.
4. Make sure that the E-mail field is set to the correct E-Mail client software.
5. Click OK.
6. Start the e-mail client software and make sure it is configured as the default MAPI client. Consult the documentation for your desktop E-Mail application for more information.

HotSync problems

Problem

I cannot perform a HotSync operation; what should I check to make sure I am doing it correctly?

Solution

Make sure the HotSync cradle is connected securely.

On a Windows computer try these steps:

- Check the Windows system tray to make sure the HotSync Manager is running. If it is not, open Palm Desktop software.
- Make sure you selected Local USB or Local Serial, as appropriate, from the HotSync Manager menu.
- If you are using the serial cradle, make sure you selected the correct serial port on the Local tab in the Setup dialog box. It should be set to the port where you connected the HotSync cradle.

On a Mac computer, try the following:

- Make sure HotSync Manager is enabled. If it is not, double-click the HotSync Manager icon in the Palm folder and enable HotSync Manager on the HotSync Controls tab.
- On a Windows computer, click the HotSync Manager and choose Custom. Check that the correct conduit is active.
- On a Mac computer, double-click the HotSync Manager icon. From the HotSync menu, choose Conduit Settings. Select your username from the User pop-up menu, and check that the correct conduit is active.

I performed a HotSync operation, but one of my applications did not synchronize.

I am using Outlook as my PIM, but I cannot do a HotSync operation.

- Click the HotSync Manager and choose Custom. Check that the correct conduit is active.
- Check that the correct conduit is installed. Reinstall the HotSync Manager and make sure the correct conduit is selected.

I cannot launch the HotSync Manager.

- If you are using the optional serial cradle, or if you are performing a HotSync operation using a modem, make sure you are not running another program, such as America Online, that uses the serial port you selected in the Setup dialog box.
- Back up the Palm Desktop software, uninstall it, and then reinstall it.

I tried to perform a local HotSync operation, but it did not complete successfully.

- Make sure your handheld is seated in the cradle correctly.
- Check the connection between the HotSync cradle and the USB or serial port on your computer.
- Make sure the username you selected in Palm Desktop software matches the username assigned to your handheld.
- Make sure the date on your computer matches the date on your handheld.
- Read the HotSync Log for the user account for which you are performing a HotSync operation.

On a Windows computer, try each step in turn:

- Make sure HotSync Manager is running. If it is running, close it, and restart it.
- Make sure you selected Local USB or Local Serial, as appropriate, from the HotSync Manager menu.
- If you are using the serial cradle, make sure you selected the correct serial port on the Local tab in the Setup dialog box. It should be set to the port where you connected the HotSync cradle.
- If you are using the serial cradle, try a lower baud rate setting on the Local tab in the Setup dialog box.
- If you are using the serial cradle, make sure you aren't running a program, such as America Online, that uses the serial port you selected in the Setup dialog box.

On a Mac computer, try the following:

- Make sure that HotSync Manager is enabled on the HotSync Controls tab in the HotSync Software Setup window.

I tried to perform a modem HotSync operation, but it did not complete successfully.

Check the following on your computer:

- Make sure your computer is turned on and that it does not shut down automatically as part of an energy-saving feature.
- Make sure the modem connected to your computer is turned on and is connected to the outgoing phone line.
- Make sure the modem you are using with your handheld has an on-off switch. Your handheld cannot “wake up” a modem that has an auto-off feature.
- Make sure the modem is connected properly to your computer and is connected to the incoming phone line.

On a Windows computer, check the following:

- Make sure that Modem is checked in the HotSync Manager menu.
- Confirm that the Setup String in the Setup dialog box configures your modem correctly. You may need to select a different Modem Type or enter a custom Setup String. Most modems have a Setup String that causes them to send initial connection sounds to a speaker. You can use these sounds to check the modem connection.
- Confirm that the Speed setting in the Setup dialog box works for your modem. If you have problems using the As Fast As Possible option or a specific speed, try using a slower speed.
- Make sure you are not running another program, such as WinFax, CompuServe, or America Online, that uses the serial port you selected in the Setup dialog box.
- Make sure your modem resets before you try again. (Turn off your modem, wait a minute, and then turn it back on.)

On a Mac computer, check the following:

- Make sure that Modem is selected on the Connection Settings tab in the HotSync Software Setup window.
- You may need to select a different Modem type or enter a Custom setup string on the Connection Settings tab. Most modems have a setup string that causes them to send initial connection sounds to a speaker. You can turn on the Modem Speaker option and use these sounds to check the modem connection.

I tried to perform a modem HotSync operation, but it did not complete successfully.
(continued)

- Make sure you are not running another program, such as America Online, fax or telephony software, or AppleTalk networking, that uses the serial port you selected in the Serial Port Settings tab.
- Make sure your modem resets before you try again. (Turn off your modem, wait a minute, and then turn it back on.)

Check the following on your handheld:

- Confirm that the telephone cable is securely attached to your modem.
- Make sure the dialing instruction dials the correct phone number.
- If you need to dial an outside line prefix, make sure you selected the Dial Prefix option on your handheld and entered the correct code.
- If the telephone line you are using has Call Waiting, make sure you selected the Disable call waiting option under Modem Sync Phone Setup on your handheld and entered the correct code.
- Make sure the telephone line you are using is not noisy, which can interrupt communications.
- Check the batteries in your modem and replace them if necessary.

I can't perform an IR HotSync operation.

- On a Windows computer, be sure the HotSync Manager is running and the Serial Port for local operations is set to the simulated port for infrared communication. See [“Conducting IR HotSync operations”](#) in [Chapter 20](#) for details.
- On a Mac, open the HotSync Software Setup window and be sure that HotSync Manager is enabled and that the IR Port Connection Setting is set to On. See [“Conducting IR HotSync operations”](#) in [Chapter 20](#) for more information.
- On your handheld, be sure the HotSync application is set to Local, with the option IR to PC/Handheld.
- Be sure the IR port of your handheld is aligned directly opposite to, and within a few inches of, the infrared device of your computer.
- IR HotSync operations do not work after you receive a low battery warning. Check the battery power of your handheld. Recharge the internal battery.

When I press the HotSync button on the cradle, nothing happens on Palm Desktop software and my handheld times out.

- Make a copy of your Palm folder. Uninstall, and then reinstall, Palm Desktop software.
- Turn on your handheld and press the Home . Tap the HotSync icon, and then tap Local.

When I perform a HotSync operation, my information does not transfer to Palm Desktop software.

- If you perform a HotSync operation for more than one device, make sure the correct user is active on the Palm Desktop software.
- If you have performed a HotSync operation successfully but you cannot find the data from your handheld on Palm Desktop software, check to see that you have the correct user name selected for viewing data.
- On a Windows computer, click the HotSync Manager and choose Custom. Check that all conduits are set to synchronize files.
- On a Mac computer, double-click the HotSync Manager icon. From the HotSync menu, choose Conduit Settings. Select your username from the User pop-up menu, and check that the correct conduit is active.

My handheld displays the message “Waiting for sender” when it’s near my computer’s infrared port.

- Your computer’s infrared port may be set to search automatically for the presence of other infrared devices. Consult the documentation for your operating system for information about turning off this option.
- In some cases, simply moving your handheld away from the computer’s infrared port solves the problem.

I want to synchronize my computer with more than one handheld.

- If the computer running Palm Desktop software synchronizes with more than one handheld, each handheld must have a unique name. Assign a username to your handheld the first time you perform a HotSync operation.
- Please be aware that synchronizing more than one handheld with the same username causes unpredictable results and, potentially, loss of your personal information.

Beaming problems

Problem

I cannot beam data to another device with an IR port.

Solution

- If you are beaming to another Palm handheld, confirm that your handheld and the other handheld are between ten centimeters (approximately 4") and one meter (approximately 39") apart, and that the path between the two handhelds is clear of obstacles. Beaming distance to other devices with an IR port may be different.
- Move your handheld closer to the receiving device.

When someone beams data to my handheld, I get a message telling me it is out of memory.

- Your handheld requires at least twice the amount of memory available as the data you are receiving. For example, if you are receiving a 30KB application, you must have at least 60KB free.
- Perform a soft reset. See [“Performing a soft reset”](#) in [Appendix A](#) for more information.

Recharging problems

Problem

When I place my handheld in the cradle, the indicator light does not go on.

Solution

- Confirm that your handheld is well seated in the cradle.
- Confirm that your recharger cable is properly connected to the back of the cradle’s USB or serial port connector that plugs into your computer.
- Confirm that your recharger is plugged into an AC outlet that has power.
- If you have not used your handheld for a long period, such as an extended vacation, the battery may not contain enough charge to power the indicator light. After your handheld has recharged, the indicator light will function normally.

Password problems

Problem	Solution
I forgot the password, and my handheld is not locked.	<p>First, use the password hint to try and remember the password. If this does not help, or if you do not have a password hint, you can use Security to delete the password, but your handheld deletes all entries marked as private. However, if you perform a HotSync operation <i>before</i> you delete the password, the HotSync process backs up all entries, whether or not they are marked private. Then you can follow these steps to restore your private entries:</p> <ul style="list-style-type: none">■ Use the Palm Desktop software and the cradle or infrared communication to synchronize your data.■ Tap Forgotten Password in Security to remove the password and delete all private records.■ Perform a HotSync operation to synchronize your data and restore the private records by transferring them from your computer to your handheld.
I forgot the password and my handheld is locked.	<p>First, use the password hint to try and remember the password. If this does not help, or if you do not have a password hint, you must perform a hard reset to continue using your handheld. See “Performing a hard reset” in Appendix A for more information.</p>

Technical support



If, after reviewing the sources listed at the beginning of this appendix, you cannot solve your problem, contact your regional technical support office by e-mail, phone, or fax.

Before requesting support, please experiment a bit to reproduce and isolate the problem. When you do contact support, please be ready to provide the following information:

- The name and version of the operating system you are using
- The actual error message or state you are experiencing
- The steps you take to reproduce the problem
- The version of handheld software you are using and available memory
- The wireless service provider’s name
- The software version of your mobile radio

To find your handheld version and memory information:



1. Press the Home .
2. Press Command Stroke  + L.

Alternately, press Function  + Menu , and then select Info on the App Menu.

NOTE Thousands of third-party add-on applications have been written for Palm OS handhelds. Unfortunately, we are not able to support such a large number of third-party applications. *If you are having a problem with a third-party application, please contact the developer or publisher of that software.*

3. Tap Version to see version numbers, and tap Size to see the amount of free memory in kilobytes.

To find your wireless service provider's name and mobile radio software version:

1. Press the Home .
2. Tap the Preferences icon .
3. Tap the pick list in the upper-right corner of the screen.
4. Select Mobile.
5. Select Current status.
6. Scroll down to SV number to view the software version of your mobile radio.

Product Regulatory and Safety Information

FCC Statement

This device complies with part 15 of the FCC rules. Operation is subject to the following two conditions: (1) This device may not cause harmful interference, and (2) this device must accept any interference received, including interference that may cause undesired operation.

NOTE This equipment has been tested and found to comply with the limits for a Class B digital device, pursuant to Part 15 of the FCC rules. These limits are designed to provide reasonable protection against harmful interference in a residential installation. This equipment generates, uses, and can radiate radio frequency energy and, if not installed and used in accordance with the instructions, may cause harmful interference to radio communications. However, there is no guarantee that interference will not occur in a particular installation. If this equipment does cause harmful interference to radio or television reception, which can be determined by turning the equipment off and on, the user is encouraged to try to correct the interference by one or more of the following measures:

- Reorient or relocate the receiving antenna.
- Increase the separation between the equipment and receiver.
- Connect the equipment into an outlet on a circuit different from that to which the receiver is connected.
- Consult the dealer or an experienced radio/TV technician for help.

The use of shielded I/O cables is required when connecting this equipment to any and all optional peripheral or host devices. Failure to do so may violate FCC rules.

CAUTION Changes or modifications not covered in this manual must be approved in writing by the manufacturer's Regulatory Engineering Department. Changes or modifications made without written approval may void the user's authority to operate this equipment.

In August 1996, the Federal Communications Commission (FCC) of the United States with its action in Report and Order FCC 96-326 adopted an updated safety standard for human exposure to radio frequency electromagnetic energy emitted by FCC regulated transmitters. Those guidelines are consistent with the safety standard previously set by both U.S. and international standards bodies. The design of this product complies with the FCC guidelines and these international standards.

Exposure To Radio Frequency Energy (SAR)

In order to comply with FCC RF exposure safety guidelines, users **MUST** use a Palm brand body-worn accessory during body-worn operation. Use of accessories not provided by Palm or that have not been tested for RF exposure compliance with this product may not comply with the FCC RF exposure safety guidelines and should not be used.

Responsible Party:

Palm, Inc.
400 N. McCarthy Blvd.
Milpitas, California 95052
United States of America
(408) 878-9000

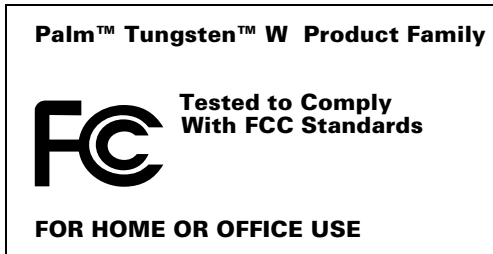

Industry Canada

The term "IC:" before the certification/registration number only signifies that the Industry Canada technical specifications were met.

Battery Warning

Do not mutilate, puncture, or dispose of batteries in fire. The batteries can burst or explode, releasing hazardous chemicals.

Varning

Eksplotionsfara vid felaktigt batteribyte. Använd samma batterityp eller en ekvivalent typ som rekommenderas av apparattillverkaren. Kassera använt batteri enligt fabrikantens instruktion.

Advarsel!

Lithiumbatteri—Eksplotionsfare ved fejlagtig håndtering. Udskiftning må kun ske med batteri af samme fabrikat og type. Levér det brugte batteri tilbage tilleverandøren.

Varoitus

Paristo voi räjähtää, jos se on virheellisesti asennettu. Vaihda paristo ainoastaan valmistajan suosittelemaan tyyppiin. Hävitä käytetty paristo valmistajan ohjeiden mukaisesti.

Advarsel

Ekspløsjonsfare ved feilaktig skifte av batteri. Benytt samme batteritype eller en tilsvarende type anbefalt av apparatfabrikanten. Brukte batterier kasseres i henhold til fabrikantens instruksjoner.

Waarschuwing!

Bij dit produkt zijn batterijen geleverd. Wanneer deze leeg zijn, moet u ze niet weggooien maar inleveren als KCA.

Uwaga

Nie kroić lub przekłuwać baterii, ani nie wrzucać ich do ognia. Mogą się rozzerwać lub wybuchnąć wydzielając trujące środki chemiczne. Zużytych baterii należy pozbywać się w sposób opisany przez producenta i zgodnie z miejscowymi przepisami.

אזהרה

יש סכנת התפוצצות אם מחליפים את הסוללה בצורה לא נכונה.
יש להחליף את הסוללה בסוללה זהה או דומה, בהתאם להמלצת היצרן.
יש להשליך סוללות משומשות בהתאם להוראות היצרן

Declaration of Conformity

Declaration of Conformity

Application of Council Directive(s): 89/336/EEC, 99/5/EC, 95/54/EC, EN60950

Standards to which Conformity is Declared:

89/336/EEC EMC directive
99/5/EC RTTE directive
95/54/EC Vehicular directive
EN60950 Safety directive
ICNIRP SAR exposure directive 1998
NAPRD 2.3.0 PTCRB compliance
GCF Field trial compliance

Manufacturers Name: Palm Inc.

Manufacturers Location: 5470 Great America Pkwy
Santa Clara, CA 95052
USA

Importers Name: Palm Germany GmbH

Importers Location: Landsberger Strasse 155
D-80687 Munchen
Germany

Type of Equipment: Handheld Computer

Model Number: Palm i710

Year of Manufacture: 2002

I, the undersigned hereby declare that the equipment specified above conforms to the above Directive(s) and Standard(s)

Place: Santa Clara, CA

Signature: _____

Date: April 20, 2002

Typed Name: David Woo

Title: Global Compliance Manager

A

ABA (Address Book archive file) 29
 Access Point Name, changing 264
 Account. *See* E-mail account
 Add-on applications
 compatibility 6
 installing using a Mac 59
 installing using Windows 57
 removing 61
 Address Book
 If Found Call entry 65
 adding custom fields 70
 adding e-mail address from 196
 adding entry from e-mail 218–219
 archive files (.aba) 29
 business card for beaming 27
 categorizing records 45
 conduit for synchronizing 285
 creating records 41
 deleting records 43
 displaying category 70
 displaying data in the Address list 66
 finding records 18, 49
 fonts 55
 menus 69
 notes for records 54
 opening 63
 overview 63
 private records 367
 sorting records 53
 using to address e-mail 196
 Addressing e-mail
 displaying another address 170, 176,
 182, 239
 message 196–198
 using Smart Addressing 197
 Addressing messages 144
 Advanced options 263
 Advanced preferences 215
 Agenda (Date Book view) 89

Alarm
 LED setting 321
 lists 56
 preset 92
 setting in Clock 281
 setting in Date Book 83
 setting in Note Pad 134
 sound 92, 282, 321, 380
 vibrate setting 321
 APN, changing 264
 APOP
 adding to an account 238, 241, 242
 and synchronization 222
 requirement 166, 238
 Application buttons 11, 33, 63, 79, 310
 Applications
 Address Book 63
 beaming 26–28
 Calculator 71
 Card Info 75
 categories 35–36
 Clock 275
 Date Book 79
 Expense 93
 font style 55
 installing 57–60
 Launcher 33–37
 Memo Pad 101
 Note Pad 131
 opening 33
 plug-in 357
 preferences for 41
 removing 61
 security 359
 sending data from 151
 To Do List 155
 viewing as icons 36
 viewing as list 36
See also Add-on applications

Archive files
 importing data from 29
 for main applications 29
 saving deleted records 44
 saving purged records 45
Archive messages 148
Attaching a signature to messages 171, 177,
183
Attachments 148
 downloading 218
 icon for 189
 selecting plug-ins 227
 sending 198
 using Documents To Go 226–227
Automatic fill, in Expense 100
Auto-off delay 320
Autotext 19

B

Back icon 256
Backing up e-mail databases 246
Backlight 11
 adjusting 15
Battery
 conserving power 320
 doesn't charge 379
 gauge 33
 life and use 370
 recycling 370
 warning 396–397
Bcc field 196
 See also Blind copies
Beaming
 location of IR port 11
 problems with 391
 ring tones 127
 See also Infrared
Blind copies 170, 171, 176, 177, 182, 183, 196,
239
Bluetooth Card. *See* Palm Bluetooth Card
Bold font for text 55
Bookmark
 adding 258
 deleting 260
 editing 259
 opening a web site 259
 overview 257

Brightness
 adjusting 15
 key location 19
 using backlight 15
Business card for beaming 27
Buttons
 mapping 310
 preferences 310

C

CA certificate
 description 266
 storing 271
Cache memory
 clear 264
 enable or disable 263
 overview 263
 reload icon 256
Calculator
 buttons explained 71–72
 memory 72
 overview 71
 recent calculations 71, 72
Calibration 17, 318
Call barring 340
 password 341
Call history, dialing from 122
Call waiting
 answering 112
 disabling 350
 setting 324
Call Waiting, disabling 299, 350
Calling card, using in phone settings 299,
351
Capitalizing, CAPS key location 20
CAPS key
 function 20
 location 20
Card Info 75
Caring for the handheld 369
Carrier. *See* Wireless carrier
Categories 147
 application 35–36
 assigning records to 45–46
 beaming 26–28
 creating 47
 default 35, 45
 displaying 46, 70, 384

- merging 48
 - renaming 48
 - using in Applications Launcher 35, 36
- Cc field 196
- Certificate
- download 271
 - friendly name 273
 - storing 271
 - supported types 271
 - view information about 257
 - viewing 273
 - WAP gateway server 257
- Certificate Authority
- description 266
 - sending information 270
- Chain calculations 72
- Check boxes 25
- Clearing Calculator entries 71
- Combining categories 48
- Comma delimited files, importing data from 29
- Command
- buttons 25
 - toolbar 23
- Command bar in VersaMail 244
- Command stroke key 23, 41
- Compressing Day view 91
- Conduits
- for modem HotSync operations 300
 - for synchronizing applications 386, 285–286, 372, 373
 - for synchronizing applications, Macintosh 286–287
- Conference call
- creating 113
 - managing 114
- Conflicting events 90
- Connecting
- service templates 352
 - to server or ISP 351
- Connection
- GPRS 312
 - GSM 315
 - IR to PC 316
 - selecting for network 349
- Connection Oriented mode 265
- Connection types
- changing in account 235
 - GPRS, prerequisite for 165
 - GPRS, using 165
 - GSM, prerequisite for 165
 - GSM, using 165
 - modem sled, prerequisite for 165
 - network connection 163
 - Palm Bluetooth Card, prerequisite for 165
 - Palm Modem accessory, prerequisite for 165
 - synchronize-only connection 163
- Connectionless mode 265
- Continuous events
- deleting from Date Book 44
 - scheduling 85
- Contrast control 15
- Contrast. *See* Brightness
- Copying
- notes into other applications 131
 - text 43
- Cradle
- connecting to computer 13
 - for local HotSync operations 288, 295
 - viewing data from 320
- Creating
- Address Book entries 64–65
 - categories 35–36, 47
 - currency symbols 97
 - custom fields in Address Book 70
 - Date Book events 79
 - Expense items 94
 - expense reports 99
 - messages 144
 - notes for records 54
 - records 41
 - signature 150
- Currency
- default 97
 - defining 97
 - for Expense items 96
- Current date 384
- Current time 33
- Custom
- currencies and symbols 97
 - fields in Address Book 70
- Cutting text 43
- Cycling through views 63, 79

D

- Data compression 313
- Data entry. *See* Entering data
- Database, upgrading a MultiMail database 162
- Databases, backing up 246
- Date
 - displaying in Clock 282
 - Expense item 95
 - setting 317
 - setting current 276, 384
 - setting preference 317
 - To Do List record due 158–159
- Date Book
 - adding Address Book data to records 51
 - Agenda view 89
 - alarm 83
 - archive files (.dba) 29
 - changing event time 83
 - changing event to untimed 83
 - conduit for synchronizing 285
 - conflicting events 90
 - continuous events 85–86
 - creating records 41, 80–83
 - Day view 87
 - deleting records 43
 - display options 91
 - end time for Day view 92
 - fonts 55
 - menus 90
 - Month view 88
 - notes for records 54
 - opening 79
 - overview 79
 - private records 367
 - purging records 44–45
 - repeating events 44, 85–86
 - scheduling events 79–81
 - selecting dates 81
 - start time for Day view 92
 - Sunday or Monday to start week 319
 - switching views 87
 - untimed events 80, 82
 - Week view 87, 319, 385
- Day (Date Book view) 80, 91
- Day, displaying in Clock 282
- DBA (Date Book archive file) 29
- Decimal point 319
- Default
 - categories 35, 45
 - currency in Expense 97
- Delete key 20
- Deleted data, saving in archive files 44
- Deleting
 - applications 61
 - Desktop software 61
 - e-mail 211–213, 239
 - filters 233
 - mail in the trash 214
 - old messages 212
 - passwords 360
 - records 43
 - service templates 357
 - text 43
 - See also* Purging records
- Desktop software
 - displaying euro 99
 - linking to external files 30, 304
 - removing 61, 62
 - saving deleted data to an archive file 44
 - upgrade 6
- Dialing phone number 110
- Digitizer 17, 318
- Disconnecting a modem 178
- Divert calls 326
- DNS (Domain Naming System) 353
- DNS number 383
- Documents To Go
 - converting attachments 226–227
 - installing new version 162
- Double-booked events 90
- Download message size 169, 175, 182, 224
- Downloading
 - messages from phone 146
 - WAP page 255
- Downloading attachments 189
- Draft messages 149
- Drafts
 - creating 194
 - saving 198, 199
- Dragging
 - memos into other applications 101
 - using the stylus 18

E

Editing records 42

E-mail

- accessing corporate e-mail 248
- adding Address Book entry from e-mail 218–219
- adding attachments 208–210
- addresses in Address Book 65
- addressing 196
- attaching files 187
- attachments 204–210
- backing up databases 246
- composing 198
- copying and pasting text 244
- creating new messages 195–198
- days to synchronize 224
- deleting messages on handheld 211–213
- deleting messages on server 239
- downloading large attachments 206–208
- drafts 199
- emptying trash 214–215
- filters for 230–231
- folder on server 239
- forwarding 201, 202
- forwarding attachments 210
- getting entire message 187
- getting on desktop 220–223
- getting subject only 187
- header details 245
- icons 189
- leaving mail on server 169, 175, 181, 238
- managing mail settings 234
- marking read and unread 215–217
- maximum message size 169, 175, 182, 224
- personal signature 200, 218
- preferences 217–218
- reading 186
- replying to 202–203
- sending 198
- signature, adding 171, 177, 183
- storing in Outbox 198
- trash 214
- viewing attachments 204–206

E-mail account

- APOP setting 238
- before setting up 165
- changing e-mail address 237

- changing mail server settings 238
- changing protocol type 235
- changing username and password 235
- checking for new messages 186, 187
- creating a synchronize-only account 171–177
- creating new 166–170, 175
- default account preconfigured by carrier 163–164
- default mail service 184–186, 236
- deleting accounts 183–184
- displaying Inbox 186
- editing 183
- editing accounts 178–240
- incoming and outgoing server 168, 174, 180
- managing mail settings 234
- outgoing mail server 239
- password 167, 173, 180
- selecting for synchronization 221
- synchronization options 220–223
- synchronizing 220, 228
- username 167, 173, 180

E-mail provider. *See* ISP, Network provider, Wireless carrier

Emergency call 6

Entering data

- importing from other applications 29–32
- using the computer keyboard 29
- using the onscreen keyboard 21

Entries. *See* Address Book

Envelope icon 189

Error log 221

ESMTP 166, 240

- adding to an account 242

Eudora, configuring for e-mail 226

Euro

- displaying on desktop computer 99
- in Expense 96, 97
- in onscreen keyboard 21
- printing 99

Events. *See* Date Book

Exclamation marks in To Do List 159

Expansion Card

- adding hardware 13
- applications 34
- copying applications 37
- described 14
- formatting 76

- renaming 76
- using cards 75

Expense

- adding Address Book data to records 52
- categorizing records 45
- creating records 94
- currency 96
- date of item 95
- defining new currency 97
- menus 100
- overview 93
- receipt details 95
- reports 99
- type 95, 100
- vendor 96

Extended MAPI 222

F

FAQs 383

FCC Statement 395

Filed messages 148

Files

- converting attachments 226–227
- error log 221

Files, linking to external 30, 304

Filters

- creating 230–232
- deleting 233
- editing 233
- examples of 233
- turning on and off 232–233

Find key 20

Finding

- Find key location 20
- information in applications 48–52
- phone numbers 51
- using the Find application 50

Fixed number dialing

- PIN2 345
- setting 342

FND

- PIN2 setting 345
- setting 342

Folders

- creating new 194
- viewing other 190

Fonts 55, 99

Formats preferences 319

Forwarding 201

Forwarding e-mail 201

Frequently asked questions (FAQs)

- application problems 384
- beaming problems 391
- HotSync problems 386
- Mobile 384
- operating problems 379
- password problems 392
- recharging problems 391
- SMS 384
- software installation problems 378
- tapping and writing problems 380
- WAP browser 383
- wireless problems 381

Frozen handheld 380

Function key

- location 20
- using 22

G

Games 321

Gateway

- changing 262
- changing stack configuration 265
- changing to secure site 256
- description 262
- secure 256
- WAP gateway address 257

General preferences 309

- alarm LED setting 321
- alarm sounds 321
- alarm vibrate setting 321
- auto-off delay 320
- system sounds 321

Generate key pairs 267

Getting e-mail

- checking for new messages 187

Go menu, Push Inbox 261

GPRS

- connection settings 313
- creating connections 312
- indicator 6
- prerequisite for connection 165
- quality of service settings 314
- setting compression 313
- using 165

Green indicator light 12

GSM

- creating connections 315
- new connection 315
- prerequisite for connection 165
- using 165

H

- Handheld, increasing space on 14
- Hard reset 371, 379
- Hardware add-ons 13
- Header compression 313
- Headset 106
- Help, online tips 26
- Hiding records 365
- HotSync
 - conduits for synchronizing
 - applications 285–286, 372, 373
 - conduits for synchronizing applications, Mac 286
 - customizing 286
 - first-time operation 287–292, 305–307
 - IR operation 292–295
 - linking to external files 30, 304
 - local operation 284, 288, 387
 - local operation on Mac 291
 - modem operation 284, 296–300, 388–389
 - modem settings 297
 - network operation 301–304
 - operations using cradle 295, 311
 - operations using IR port 292–294, 316–317
 - problems launching application 386
 - problems with 386–390
 - problems with IR 389
 - restoring data 372–373
 - setting options 283–284
 - starting Manager 219
 - synchronize active accounts 220
 - synchronizing e-mail 228
 - using with another PIM 62

I**Icon**

- alarm 83
- application 36
- back 256
- note 54

- online Tips 26
- padlock 257
- reload 256, 264
- repeating event 85
- stop 255

Icons

- for e-mail messages 189
- HotSync Manager 219
- paperclip 189
- VersaMail e-mail 189

Idle timeout of ISP or server connection 353**IMAP**

- adding an account 167, 172, 179
- ESMTP synchronization in 223
- mail retrieval options 229
- root mailbox 239
- server options 169, 175, 181
- synchronize an account 223
- wireless folder synchronization 247

IMEI number 331**Importing data 29–32****IMSI number 331****Inbox 147**

- synchronizing 224
- viewing mail 186

Incoming mail server 167, 168, 173, 174, 180

- changing 238

Indicator light

- alarm notification 12
- described 12
- problems 380
- setting 321
- showing radio status 12

Infrared

- connections 311
- HotSync operations 292–294, 316–317
- PC connection 316
- port 11, 292
- problems with IR HotSync
 - operations 389
- requirements for computer 292

Initialization string 317**Installing**

- applications 57–60
- conduit to install applications 285
- Documents To Go 162

International characters

- keyboard 20
- typing 20

Internet
 access problems 381
 password 348
 selecting connection 349
 username 347
IP address 352, 354
IR port.
 See also Beaming and Infrared
IR. *See* Infrared
IrCOMM 292, 311
IrDA (Infrared Data Association) 292
ISP
 login script 166
 requirements for 165
 requiring APOP 238, 241, 242
 requiring ESMTTP 242
 using 165
Items. *See* To Do List or Expense

K

Key pair
 changing password 268
 changing signature 268
 creating 266
 description 266
 time to generate 268
Keyboard
 computer 29
 description 19
 key clicking 322
 key repeat rate 322
 keyboard type 19
 onscreen 21
 press-and-hold 322
 remapping keys 323
 setting preferences 322
Keyboard shortcuts in VersaMail 250

L

LED alarm 321
Letters
 font style 55
 onscreen keyboard 21
List, in Applications Launcher 36
Location
 setting primary 276, 277
 setting secondary 278

Locking the handheld with a password 358, 361–364
Logging informational errors 221
Login script 166, 355–357
Looking up Address Book data
 to add to other records 51
 scrolling in Address list 49
Lost
 handheld, contact for 65
 records 384
Lotus Notes, selecting as mail client 222
Lotus Organizer, importing data from 29

M

Mac computer, system requirements 4
Mail server settings, changing 238
Mail service, default service for e-mail account 184–186, 236
Mail settings
 changing e-mail address 237
 changing mail server settings 238
 changing protocol type 235
 changing username and password 235
 managing 234
Mailbox, adding new 166
Maintenance information 369
Marking messages unread/read 215
Maximum message size
 for HotSync operation 224
 incoming e-mail 169, 175, 182
 POP and IMAP server 238
Medical emergency call 6
Memo Pad
 adding Address Book data to records 51
 archive files (.mpa) 29
 conduit for synchronizing 285
 creating records 41
 deleting records 43, 86
 dragging memos into other applications 101
 fonts 55
 menus 73, 102
 opening 101
 private records 367
 reviewing memos 102
 sorting records 53, 385

- Memory
 - for beaming 391
 - cache 263
 - Calculator 72
 - regaining 44, 379
- Memos. *See* Memo Pad
- Menu commands 23, 41
 - accessing 24
 - key location 20
 - using 23
- Menus 23, 39–41, 154
 - Address Book 69
 - choosing 40
 - command equivalents (Graffiti writing) 23, 41
 - command toolbar 23
 - commands 23
 - Date Book 90, 282
 - Edit menu 42–43
 - Expense 100
 - key location 20
 - Memo Pad 73, 102, 135
 - menu bar 24, 40
 - menu commands 24
 - mobile 128
 - Network Preferences 358
 - problems 380
 - SIM Manager 139
 - SIM Services 142
 - To Do List 160
 - WAP Browser 274
- Messages
 - archive 148
 - creating 144
 - deleted 149
 - draft 149
 - filed 148
 - folders 147
 - icons 147–148
 - multi-part 144
 - outgoing 148
 - receiving 146
 - restoring deleted 149
 - sending 146
 - signature 150
 - viewing 147
- Microsoft Exchange 5.0 222
- Microsoft Outlook
 - connecting to 386
 - synchronizing with 222
- Microsoft Outlook Express
 - configuring for e-mail 225
 - selecting as mail client 222
- Mobile
 - adjusting volume 107
 - answering call 109
 - answering call waiting 112
 - call history dialing 122
 - cell location 331
 - conference call 113
 - dialing 110
 - IMEI number 331
 - IMSI number 331
 - managing phone calls 111
 - managing profiles 124
 - managing ring tunes 126
 - menus 128
 - opening 108
 - phone number 331
 - problems connecting 384
 - redial 110
 - redial reminder 112
 - retrieving voicemail 117
 - setting network search mode 333
 - software version number 331
 - speed dialing 118
 - tower location 331
 - using headset 106
 - using redial reminders 123
- Mobile carrier 331
- Mobile preferences 324
 - call barring 340
 - call waiting 324
 - conceal number 325
 - current status 331
 - divert calls 326
 - fixed number dialing 342
 - GPRS usage 332
 - network selection 333
 - preferred network 334
 - setting PIN 337
 - track phone time 330
 - unlocking SIM card 339
- Mobile radio
 - changing PIN 338
 - current status 331

- description 5
 - PUK 339
 - setting PIN 337
 - statistics 331
 - turning on and off 324
- Mode 265
- Modem
- auto-disconnect 178
 - HotSync operations via 296–300, 388–389
 - initialization string 317
 - initializing 178
 - preferences 177
 - timeout 178
- Modem sled, prerequisite for connection 165
- Monday, to start week 319
- Month (Date Book view) 88, 91
- MPA (Memo Pad archive file) 29
- MultiMediaCard 10
- See also* Expansion Card
- Multi-part messages 144
- Multiple addressees 196
- ## N
- Navigator 18
- accessing international characters 21
 - description 11
 - in VersaMail 248
 - location 10, 11
 - look up Address Book record 49
 - scroll 26
 - scroll in Address Book 65
- Netscape 222
- Network
- connecting 351
 - HotSync operation 301–304
 - idle timeout 353
 - login scripts 355–357
 - password 348
 - phone settings 349
 - preferences 383
 - primary DNS 353
 - secondary DNS 353
 - selecting connection 349
 - selecting service 347
 - user name 347
- Network connection 163
- adding preferred network 335
 - connection methods 163
 - GPRS, prerequisite for 165
 - GPRS, using 165
 - GSM, prerequisite for 165
 - GSM, using 165
 - modem sled, prerequisite for 165
 - Palm Bluetooth Card, prerequisite for 165
 - Palm Modem accessory, prerequisite for 165
 - preferred network settings 334
 - problems establishing 382
 - search mode 333
 - use statistics 332
- Nokia ring tunes 127
- Note Pad
- alarm 134
 - copying notes into other applications 131
 - menus 135
 - opening 131
 - overview 131
 - reviewing notes 132
- Notes, attaching to records 54
- Numbers
- decimal point and thousands separator 319
 - onscreen keyboard 21
- ## O
- Old messages, deleting 211
- Onscreen keyboard 21, 43
- Opening
- Address Book 63
 - applications 33
 - Calculator 71
 - Clock 275
 - Date Book 79
 - Memo Pad 101
 - Note Pad 131
 - To Do List 155
- Organizer (Lotus PIM) 29
- Outbox 148, 194
- storing e-mail 198
 - synchronizing 224
- Outgoing server, settings 168, 174, 180, 239
- Outlook, connecting to 386

Overlapping events 90
Owner preferences 358

P

Padlock icon 257
Palm Bluetooth Card, prerequisite for connection 165
Palm Modem accessory, prerequisite for connection 165
Palm OS upgrade 3
Paperclip icon 189
Password 167, 173, 180

- call barring 341
- changing 235, 269, 360
- characters used 268
- creating key pair 266
- deleting 360
- description 266
- editing in account 178
- for network 348
- forgotten 364, 392

Pasting

- notes into other applications 131

Pasting text 43
Payment, Expense item 96
Peripheral hardware 13
Phone

- downloading messages from 146
- Lookup 51
- settings for ISP or dial-in server 349

Phone call

- adding note 112
- answering 109
- answering call waiting 112
- call history dialing 122
- conference calling 113
- managing 111
- save to Address Book 112
- speed dialing 118
- voicemail 117

Phone headset

- using 106
- using button 106

Phone number

- barring 340
- conceal 325
- dialing 110
- redial 110
- your mobile 331

Phone numbers

- selecting for Address list 66
- selecting types 65

Phone profiles, managing 124
Pick lists 25
PIM (personal information manager), using HotSync Manager with 62
PIN 337
PIN2 345
PKI 266
Plug-ins 227, 357
POP accounts, APOP synchronization in 222
POP3 accounts 169, 175, 181

- adding an account 167, 172, 179

Port number 238, 240, 265
Ports

- IR on handheld 292
- serial 4, 5
- USB 4, 5

Power button 11
PPP 352
PRC (application file extension) 58, 357
Preferences

- Advanced 215
- Buttons 310
- choosing 41
- Connection 311–317
- cradle setting 320
- Date and Time 317–318
- deleting e-mail 217
- Digitizer 318
- Formats 319
- General 309, 320
- getting mail 217
- Keyboard 322–323
- mail databases 246
- Mobile 324–346
- modem 177
- Network 346–358
- Owner 358
- Security 359–367
- ShortCuts 367
- SMS 152–154
- Trash 215
- viewing 310

Preferred network
 sort priority 335
 viewing 334
Primary DNS 353
Prioritizing To Do List records 156, 159
Private records
 displaying and creating 365–367, 384
 lost with forgotten password 364
Profile 223
Profile, Mobile user 305
Protocol, changing type 235
Public Key
 infrastructure 266
 viewing 270
PUK 339
Purging
 records 44–45
 See also Deleting
Push Inbox
 description 261
 opening 261
Push message 262

R

Radio status 12
Range of times in Day view 92
Read messages, marking 215
Reading e-mail 186–189
Receipts, recording in Expense 95
Receiving messages 146
Recharging the battery 320
Records
 beaming 26–28
 choosing categories 45
 creating 41
 Date Book 80
 defined 41
 deleting 43, 86
 displaying a category of 46
 editing 42
 Expense 94
 fonts 55
 hiding private 359, 365
 lost 384
 masking private 359
 Memo Pad 101
 notes for 54
 private 365–367

 purging 44–45
 sorting 53
 To Do List 156
 unmasking individual 366
Red indicator light 12
Redial reminder
 creating 123
 managing 124
 setting 112
 using 123
Registering Documents To Go 162
Reload icon 256, 264
Reminder lists 56
Removing
 applications 61
 Desktop software 61
Renaming categories 48
Repeating events
 deleting from Date Book 44
 scheduling 85
Replying to e-mail 202
Rescheduling events 83
Resetting handheld
 hard reset 371, 379
 location of reset button 13, 371
 soft reset 370
Restoring data
 Mac 373
 Windows 372
Ring tones
 beaming 127
 deleting 127
 managing 126
 Nokia 127
Root certificate 271

S

Safety emergency call 6
Saving
 data 34, 41, 44
 e-mail databases 246
 e-mail messages 212
Scheduling events 79–83
Screen
 backlight 11
 blank 379
 calibrating 17, 318

- caring for 369
- touching with your finger 12
- Scroll bar 26
- SD card 10
- Searching. *See* Finding
- Secondary DNS 353
- Secure gateway, transfer permission 256
- Secure mode 265
- Secure WAP site 256
- Security 359–365
 - changing password 360
 - creating password or signature 266
 - deleting password 360
 - forgotten password 364
 - private records 365–367
 - setting a password hint 360
 - unmasking individual records 366
 - using 266
- Selecting
 - date for event 81
 - phone numbers in Address Book 65
 - text 42, 43
- Sending
 - data from applications 151
 - e-mail 198
 - messages 146
- Serial port 4, 5, 284, 296, 297
- Server
 - deleting messages on 214, 217
 - sent mail folder 239
- Server certificate 271
- Service
 - selecting for network 347
 - templates 352, 357
- Settings. *See* Preferences
- ShortCuts
 - backing up 285
 - for entering data 24, 368
 - key location 20
 - managing 367–368
 - menu commands 23, 41
 - preferences 367
 - using 24
- Signal strength
 - indicator 256
 - location 6
 - weak 381
- Signature 171, 177, 183
 - adding to a message 150
 - attaching personal 200, 218
 - changing 268–271
 - characters used 268
 - creating key pair 266
- Signed public key 270
- SIM card
 - installing 374
 - removing 375
 - unlocking 339
 - verifying installation 374
- SIM Manager
 - adding records 138
 - menus 139
- SIM Services
 - accessing a service 142
 - menus 142
- SMAPI (Simple MAPI) 222
- Smart Addressing
 - turning on 198
 - using 197
- SMS
 - menus 154
 - overview 143
 - preferences 152–154
 - problems connecting 384
- SMTP settings 239
- Soft reset 371
- Sorting
 - applications 35
 - records 53, 385
- Sounds. *See* Alarm *and* System sounds
- Special characters, typing 20
- Speed dial
 - creating entry 118
 - dialing 119
 - editing 120
 - using 118
- Spelling correction, automatic 19
- Stack configuration 257
- Starting applications 33
- Stop icon 255
- Stylus
 - dragging with 18
 - tapping with 17
- Sunday, to start week 319
- Symbol key 20
- Symbol, for currency 96
- Synchronize-only account, creating 171–177
- Synchronize-only connection 163

Synchronizing an existing username 162

Synchronizing e-mail 228

active accounts 228

e-mail applications for 222

HotSync operation 220

logging errors 221

setting how many days 224

turn off synchronization 228

Synchronizing IMAP folders 247

System

conduit 285

sounds 321

System requirements 4

T

Tab delimited files, importing data from 29

Tab key 19

Tapping 17

TCP/IP 346

TDA (To Do List archive file) 29

Technical support 377, 392

Text

copying 43

copying and pasting in e-mail 244

cutting 43

entry. *See* Entering data

files, importing data from 29, 31

fonts for 55

selecting all 43

Thousands separator 319

Time

alarm setting 83

format 319

setting current 277, 318

setting event 80

setting preference 317

start and end for Date Book Day view 92

Time Zone 279

setting 318

Tips, online 26

To 237

To Do List

adding Address Book data to records 51

archive files (.tda) 29

categorizing records 45, 159

checking off items 157

completed items 159

completion date 159

conduit for synchronizing 285

creating records 41

deleting records 43, 86

due date 158–159

fonts 55

menus 160

notes for records 54

opening 155

overview 155

prioritizing records 156, 159

private records 367

purging records 44–45, 159

sorting records 54

To field 196

Today. *See* Current date

Track phone time 330

Trash 149

automatically emptying 215

creating other folders 194

emptying deleted e-mail 214–215

setting frequency in preferences 215

Troubleshooting 384, 389

Turning off handheld

automatically 320

problems with 380

Turning on handheld

displaying owner's name 358

power button 11

problems with 379

U

Undoing actions 43

Uninstalling Desktop software 61

Universal connector 13, 311

Unread mail 169, 175, 181, 238

Unread messages, marking 215

Unresponsive handheld 380

Untimed events 80, 82, 83, 84

Upgrading 3

Upgrading a MultiMail database 162

USB

infrared communication 295

Local tab settings 284

port 4, 5

User certificate 271

User profiles, HotSync operation with 306–307

Username 167, 173, 180
 changing 235
 editing in account 178
 entering 235
 for ISP 347
 identifying handheld 358
 synchronizing existing 162

V

vCal 29
vCard 29
Vendor for Expense item 96
VersaMail
 icons 189
 setting preferences for 217
VersaMail application 161–251
Vibrate alarm 321
Viewing
 archive messages 148
 deleted messages 149
 draft messages 149
 incoming messages 147
 messages with attachments 148
 messages, overview 147
 outgoing messages 148
Voice jack 13
Voicemail, retrieving 117
Volume dialog box 107
Volume, adjusting headset 107

W

WAP Browser
 menus 274
 problems 383
WAP Identity Module
 description 266
 protect with password 266
 viewing certificate 273
WAP page
 bookmark 258
 download new 264
 downloading 255
WAP site
 browsing 255
 opening 254
 secure sites 256
 title bar 255

WAP stack configuration, changing 265
Web
 Documents To Go 162
 sites 383
Week (Date Book view) 87–88, 319, 385
WIM
 description 266
 protect with password 266
 viewing certificate 273
Windows, system requirements 4
Wireless carrier
 default e-mail account 163–164
Wireless features 5
Wireless modem 178
Wireless service provider
 access services 142
 password 348
 username 347
World Clock
 alarm 281
 alarm preferences 282
 display options 282
 menus 282
 opening 275
 Time Zone 279
Writing area 11
Writing. *See* Entering data
WTLS Conn. Oriented mode 265
WTLS Connectionless mode 265

