

OLYMPUS®

DIGITAL CAMERA

E-M1

Instruction Manual

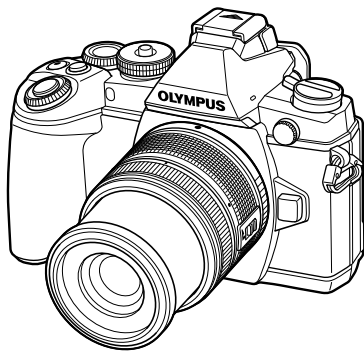

Table of Contents

Quick task index

1. Preparing the camera and flow of operations
2. Shooting using the viewfinder
3. Shooting using live view
4. Viewing photographs and movies
5. Basic operations
6. Using shooting options
7. Menu functions
8. Printing pictures
9. Connecting the camera to a computer and a smartphone
10. Battery, battery charger, and card
11. Interchangeable lenses
12. Using separately sold accessories
13. Information
14. SAFETY PRECAUTIONS

■ Thank you for purchasing an Olympus digital camera. Before you start to use your new camera, please read these instructions carefully to enjoy optimum performance and a longer service life. Keep this manual in a safe place for future reference.

■ We recommend that you take test shots to get accustomed to your camera before taking important photographs.

■ The screen and camera illustrations shown in this manual were produced during the development stages and may differ from the actual product.

■ The contents in this manual are based on firmware version 1.0 for this camera. If there are additions and/or modifications of functions due to firmware update for the camera, the contents will differ. For the latest information, please visit the Olympus website.

- This notice concerns the supplied flash unit and is chiefly directed to users in North America.

Information for Your Safety

IMPORTANT SAFETY INSTRUCTIONS

When using your photographic equipment, basic safety precautions should always be followed, including the following:

- Read and understand all instructions before using.
- Close supervision is necessary when any flash is used by or near children. Do not leave flash unattended while in use.
- Care must be taken as burns can occur from touching hot parts.
- Do not operate if the flash has been dropped or damaged - until it has been examined by qualified service personnel.
- Let flash cool completely before putting away.
- To reduce the risk of electric shock, do not immerse this flash in water or other liquids.
- To reduce the risk of electric shock, do not disassemble this flash, but take it to qualified service personnel when service or repair work is required. Incorrect reassembly can cause electric shock when the flash is used subsequently.
- The use of an accessory attachment not recommended by the manufacturer may cause a risk of fire, electric shock, or injury to persons.

SAVE THESE INSTRUCTIONS

Indications used in this manual

The following symbols are used throughout this manual.





 Cautions	Important information on factors which may lead to a malfunction or operational problems. Also warns of operations that should be absolutely avoided.
 Notes	Points to note when using the camera.
 Tips	Useful information and hints that will help you get the most out of your camera.
	Reference pages describing details or related information.

Table of Contents

Quick task index	7	Setting shooting functions 28	
Unpack the box contents	9	Using live guides28	
Preparing the camera and flow of operations	10	Using live control 30	
Names of parts	10	Viewing photographs and movies	31
Charging and inserting the battery	12	Viewing photographs and movies 31	
Inserting and removing cards ...	13	Index display/Calendar display	31
Attaching a lens to the camera	14	Viewing still images	32
Attaching the flash unit	15	Watching movies	32
Power on	16	Volume.....	32
Setting the date/time	17	Protecting images.....	32
Setting the shooting mode	18	Erasing images.....	33
Selecting a shooting method	19	Selecting images	33
Shooting using the viewfinder	20	Using the touch screen 34	
Shooting	20	Selecting and protecting images.....	34
Shooting still pictures.....	20	Basic operations	35
Recording movies.....	22	Information displays while shooting	35
Setting shooting functions	23	Viewfinder display when shooting using the viewfinder.....	35
Using the Multi-function button.....	23	Monitor display when shooting using live view	36
Using the super control panel...24		Switching the information display	37
Shooting using live view	25	Using the shooting modes	38
Shooting	25	“Point-and-shoot” photography (P program mode).....	38
Shooting still pictures.....	25	Choosing aperture (A aperture-priority mode)	39
Recording movies.....	26	Choosing shutter speed (S shutter-priority mode)	40
Using the touch screen	27	Choosing aperture and shutter speed (M manual mode).....	41
Selecting a focusing method27			
Using the wireless LAN function.....	27		

Using movie mode (Ⓜ).....	42
Adding effects to a movie [Movie Effect].....	42
Using art filters.....	44
Shooting in scene mode.....	45
Using PHOTO STORY.....	47
Commonly used shooting options.....	49
Controlling exposure (exposure compensation).....	49
Changing the brightness of highlights and shadows.....	49
Locking the exposure (AE Lock).....	49
Using a flash (flash photography).....	50
Choosing a focus target (AF Area).....	52
Setting the AF target.....	52
Face priority AF/pupil detection AF.....	53
Zoom frame AF/zoom AF.....	54
Sequential shooting/using the self timer.....	55
Adjusting color (white balance).....	56
ISO sensitivity.....	57
Controlling color (Color Creator).....	58
HDR photography.....	59
Information display during playback.....	60
Playback image information.....	60
Switching the information display.....	60
Changing the playback information display method.....	61
Sharing images over Wi-Fi connection (Share Order).....	62
Manipulating playback images.....	63
Using shooting options.....	66
Reducing camera shake (image stabilizer).....	66
Processing options (picture mode).....	68
Adding effects to a movie.....	69
Setting the image aspect.....	69
Image quality (record mode).....	70
Adjusting flash output (flash intensity control).....	71
Choosing how the camera measures brightness (metering).....	72
Choosing a focus mode (AF mode).....	73
Movie sound options (recording sound with movies).....	74
Menu functions.....	75
Basic menu operations.....	75
Using Shooting Menu 1/ Shooting Menu 2.....	76
Formatting the card (Card Setup).....	76
Restoring default settings (Reset/Myset).....	77
Processing options (Picture Mode).....	78
Image quality (⏪).....	79
Setting the self timer (⏱/⏲).....	79
Varying settings over a series of photographs (bracketing).....	80
Recording multiple exposures in a single image (multiple exposure).....	82
Shooting automatically with a fixed interval (time lapse shooting).....	83
Wireless remote control flash photography.....	84
Digital Zoom (Digital Tele-converter).....	84
HDR photography.....	84

Using the playback menu85	Adding information displays (Info Settings).....105
Displaying images rotated (Info).....85	Shutter speeds when the flash fires automatically [X-Sync.] [Slow Limit].....106
Editing still images.....85	AF focus adjustments.....107
Canceling all protections.....87	
Using the Smartphone connection option (Connection to Smartphone).....87	
Using the setup menu88	Using the accessory port menus108
Date/time setting.....88	Before using the accessory port menus.....108
(Changing the display language).....88	Using OLYMPUS PENPAL.....109
(Monitor brightness adjustment).....88	OLYMPUS PENPAL Share.....110
Rec View.....88	OLYMPUS PENPAL Album.....111
Wi-Fi Settings.....88	Electronic Viewfinder.....111
Menu Display.....88	
Firmware.....88	
Setting up a wireless LAN connection (Wi-Fi Settings).....89	
Using the custom menus90	
AF/MF.....90	Printing pictures112
Button/Dial/Lever.....91	Print reservation (DPOF)112
Release/.....91	Creating a print order.....112
Disp/)/PC.....92	Removing all or selected pictures from the print order ... 112
Exp/ISO.....93	Direct printing (PictBridge)113
Custom.....94	Easy printing.....114
Color/WB.....95	Custom printing.....114
Record/Erase.....96	
Movie.....97	Connecting the camera to a computer and a smartphone 116
Built-In EVF.....97	Installing the PC software116
Utility.....98	Copying pictures to a computer without OLYMPUS Viewer 3118
AEL/AFL.....98	Using the camera wireless LAN function119
MF Assist.....99	Things you can do with OI.Share121
Button Function.....99	
Lever Function.....101	
Viewing camera images on TV.....101	
Choosing the control panel displays (Control Settings).....103	

Battery, battery charger, and card 122

- **Battery and charger** 122
- **Using an optional AC adapter**.... 122
- **Using your charger abroad** 122
- **Usable cards** 123
- **Record mode and file size/
number of storable still
pictures** 124

Interchangeable lenses 125

- M.ZUIKO DIGITAL lens
specifications 125

Using separately sold accessories 129

- **Power Battery Holder
(HLD-7)** 129
- **External flash units designated
for use with this camera** 130
 - Wireless remote control flash
photography..... 131
- **Other external flash units** 132
- **Principal Accessories** 133
- **System chart**..... 134

Information 136

- **Shooting tips and
information**..... 136
- **Error codes** 138
- **Cleaning and storing the
camera**..... 140
 - Cleaning the camera 140
 - Storage 140
 - Cleaning and checking the
image pickup device 140
 - Pixel Mapping - Checking the
image processing functions 141
- **Menu directory**..... 142
- **Specifications** 148

SAFETY PRECAUTIONS 151

- **SAFETY PRECAUTIONS** 151

Index 161

Quick task index

Shooting



Taking pictures with automatic settings	▶ iAUTO (iAUTO)	18
Easy photography with special effects	▶ Art filter (ART)	44
Choosing an aspect ratio	▶ Aspect ratio	69
Quickly matching settings to the scene	▶ Scene mode (SCN)	45
Pro-level photography made simple	▶ Live Guide	28
Adjusting the brightness of a photograph	▶ Exposure compensation	49
Taking pictures with a blurred background	▶ Live Guide	28
	▶ Aperture priority shooting	39
Taking pictures that stop the subject in motion or convey a sense of motion	▶ Live Guide	28
	▶ Shutter priority shooting	40
Taking pictures with the correct color	▶ White balance	56
	▶ One-touch white balance	57
Processing pictures to match the subject/ Taking monotone pictures	▶ Picture Mode	68
	▶ Art filter (ART)	44
When the camera will not focus on your subject/ Focusing on one area	▶ Using the touch screen	27
	▶ AF Area	52
	▶ Zoom frame AF/zoom AF	54
Focusing on a small spot in the frame/ confirming focus before shooting	▶ Zoom frame AF/zoom AF	54
Recomposing photographs after focusing	▶ C-AF+TR (AF tracking)	73
Turning off the beep speaker	▶ ■)) (Beep sound)	93
Taking photos without the flash	▶ ISO/DIS Mode	57/45
Reducing camera shake	▶ Image Stabilizer	66
	▶ Anti-Shock [▲]	94
	▶ Self-timer	55
	▶ Remote cable	133
Taking pictures of a subject against backlight	▶ Flash shooting	50
	▶ Gradation (Picture Mode)	78
Photographing fireworks	▶ Bulb/time photography	41
	▶ Scene mode (SCN)	45
Reducing image noise (mottling)	▶ Noise Reduct.	93
Taking pictures without white subjects appearing too white or black subjects appearing too dark	▶ Gradation (Picture Mode)	78
	▶ Histogram/ Exposure compensation	37/49
	▶ Highlight&Shadow Control	49
Optimizing the monitor/ adjusting monitor hue	▶ Monitor brightness adjustment	88
	▶ Live View Boost	92

Checking set effect before taking a picture	▶ Preview function	100
	▶ Test Picture	100
Checking horizontal or vertical orientation before shooting	▶ Level gauge	37
Shooting with deliberate composition	▶ Displayed Grid	92
Zooming in on photos to check focus	▶ Auto [] (Rec View)	88
Self-portraits	▶ Self-timer	55
Sequential shooting	▶ Sequential shooting	55
Extending the useful life of the battery	▶ Sleep	93
Increasing the number of pictures that can be taken	▶ Record mode	70

Playback/Retouch

Viewing images on a TV	▶ HDMI/Video Out	92
	▶ Playback on TV	101
Viewing slideshows with background music	▶ Slideshow	65
Brightening shadows	▶ Shadow Adj (JPEG Edit)	86
Dealing with red-eye	▶ Redeye Fix (JPEG Edit)	86
Printing made easy	▶ Direct printing	113
Commercial prints	▶ Creating a print order	112
	▶ Share Order	62
Simple photo sharing	▶ Using the camera wireless LAN function	119
	▶ OLYMPUS PENPAL	109
	▶ Connection to Smartphone	87

Camera Settings

Restoring default settings	▶ Reset	77
Saving the settings	▶ Myset	77
Changing the menu display language	▶ 	88

Unpack the box contents

The following items are included with the camera.

If anything is missing or damaged, contact the dealer from whom you purchased the camera.



Camera



Body cap



Strap

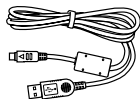

USB cable
CB-USB6

- Flash case
- Computer software CD-ROM
- Instruction manual
- Warranty card



Flash
FL-LM2



Lithium ion battery
BLN-1



Lithium ion charger
BCN-1

Attaching the strap

- 1 Thread the strap in the direction of the arrows.

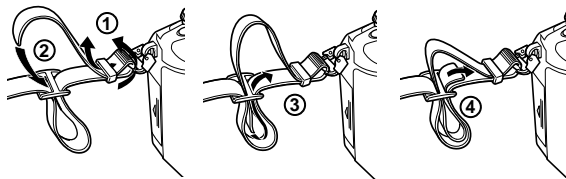



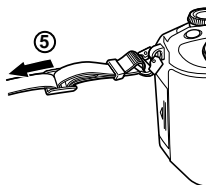



- 2 Lastly, pull the strap tight making sure that it is fastened securely.

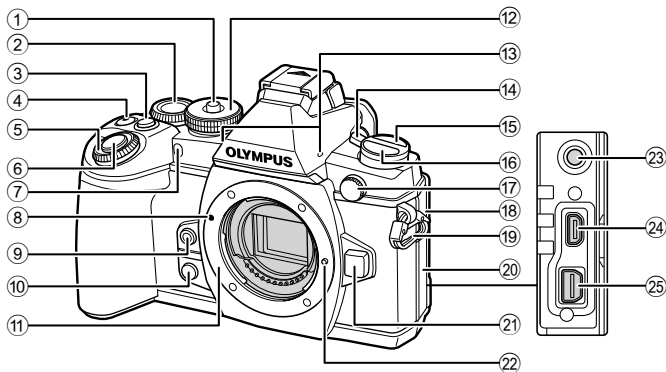

- Attach the other end of the strap to the other eyelet in the same way.

Names of parts



- | | |
|--|---|
| ① Mode dial lock.....P. 18 | ⑭ ON/OFF lever.....P. 16 |
| ② Rear dial* ¹ (☺)
.....P. 23, 38–41, 56, 58, 105 | ⑮ AF  (AF/Metering mode) button
( /⑮ settings* ²).....P. 50, 71, 72, 73 |
| ③ Fn2 buttonP. 23, 49 | ⑯  HDR (Sequential shooting/Self-timer/HDR) button
(Bracket settings* ²)P. 55, 37, 80 |
| ④  /☺ (Movie) buttonP. 33/P. 22, 99 | ⑰ External flash connectorP. 132 |
| ⑤ Front dial* ¹ (☺)P. 31, 38–41 | ⑱ Microphone connector cover |
| ⑥ Shutter buttonP. 21 | ⑲ Strap eyelet.....P. 9 |
| ⑦ Self-timer lamp/AF illuminator
.....P. 55/P. 91 | ⑳ Connector cover |
| ⑧ Lens attachment markP. 14 | ㉑ Lens release buttonP. 14 |
| ⑨  (One-touch white balance) button
.....P. 57 | ㉒ Lens lock pin |
| ⑩  (Preview) buttonP. 39 | ㉓ Microphone connector (Third-party commercial microphones can be used.
ø3.5 stereo mini-plug) |
| ⑪ Mount (Remove the body cap before attaching the lens.) | ㉔ HDMI connector (Type D).....P. 101 |
| ⑫ Mode dialP. 18 | ㉕ Multi-connectorP. 101, 113, 116 |
| ⑬ Stereo microphoneP. 64, 74, 87 | |

*¹ In this manual, the ☺ and ☺ icons represent operations performed using the front dial and rear dial.

*² When the lever is set to 2

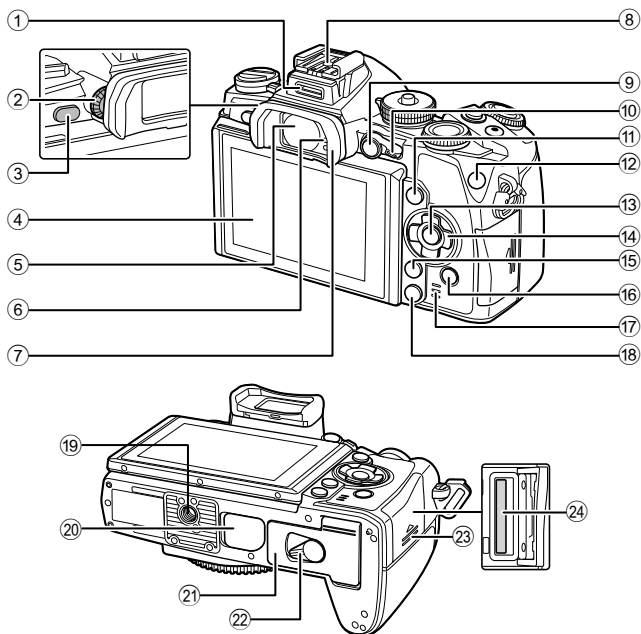

- | | |
|--|---------------------------------------|
| ① Accessory port.....P. 108 | ⑬ buttonP. 30, 75 |
| ② Diopter adjustment dial.....P. 20 | ⑭ Arrow pad*P. 31 |
| ③ (LV) buttonP. 19 | ⑮ MENU button.....P. 75 |
| ④ Monitor (Touch screen)
.....P. 16, 27, 34, 36, 60 | ⑯ (Playback) button.....P. 31, 61 |
| ⑤ ViewfinderP. 19, 20, 39 | ⑰ Speaker |
| ⑥ Eye sensor | ⑱ (Erase) buttonP. 33 |
| ⑦ Eyecup.....P. 133 | ⑲ Tripod socket |
| ⑧ Hot shoeP. 130 | ⑳ PBH cover.....P. 129 |
| ⑨ AEL/AFL button.....P. 32, 49, 98 | ㉑ Battery compartment cover.....P. 12 |
| ⑩ Lever.....P. 38–41, 91 | ㉒ Battery compartment lock.....P. 12 |
| ⑪ INFO buttonP. 37, 60 | ㉓ Card slot cover.....P. 13 |
| ⑫ Fn1 buttonP. 52 | ㉔ Card slotP. 13 |

* In this manual, the icons represent operations performed using the arrow pad.

Charging and inserting the battery

1 Charging the battery.

Charging indicator

	BCN-1
Charging in progress	Lights orange
Charging complete	Off
Charging error	Blinks orange

(Charging time: Up to approximately 4 hours)

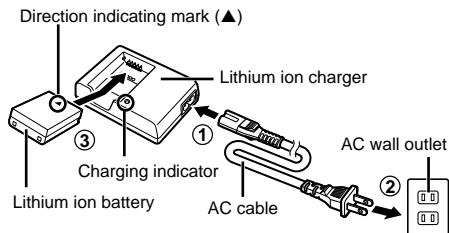

⚠ Cautions

- Unplug the charger when charging is complete.

2 Loading the battery.

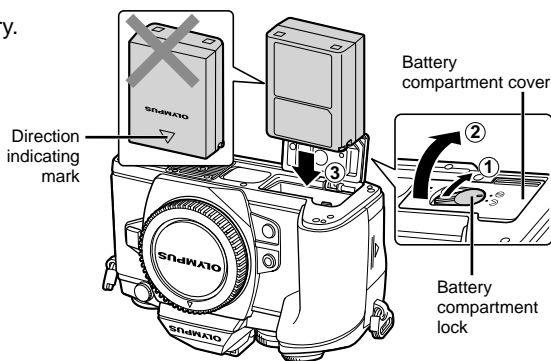

3 Closing the battery cover.

Removing the battery

Turn off the camera before opening or closing the battery compartment cover. To remove the battery, first push the battery lock knob in the direction of the arrow and then remove.



⚠ Cautions

- Contact an authorized distributor or service center if you are unable to remove the battery. Do not use force.

📝 Notes

- It is recommended to set aside a backup battery for prolonged shooting in case the battery in use drains.
- Also read "Battery, battery charger, and card" (P. 122).

Inserting and removing cards

1 Loading the card.

- Open the card slot cover.
- Slide the card in until it is locked into place.
☞ "Usable cards" (P. 123)

⚠ Cautions

- Turn off the camera before loading or removing the card.

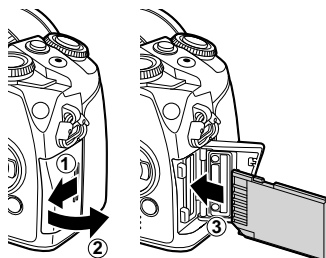

2 Closing the card slot cover.

- Close firmly until you hear a click.

⚠ Cautions

- Be sure the card slot cover is closed before using the camera.

Removing the card

Press the inserted card lightly and it will be ejected.
Pull out the card.

⚠ Cautions

- Do not remove the battery or card while the card write indicator (P. 36) is displayed.

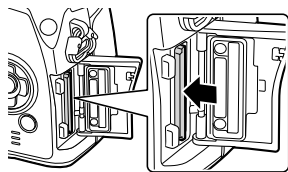

Eye-Fi Cards

Read "Usable cards" (P. 123) before use.

Attaching a lens to the camera

1 Attach a lens to the camera.

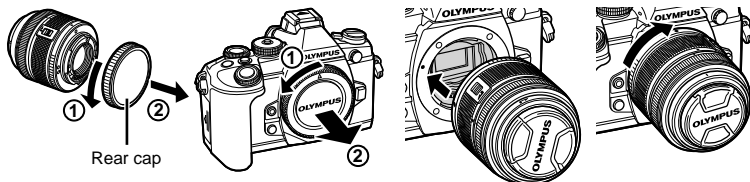

- Align the lens attachment mark (red) on the camera with the alignment mark (red) on the lens, then insert the lens into the camera's body.
- Rotate the lens in the direction indicated by the arrow until you hear it clicks.

! Cautions

- Make sure the camera is turned off.
- Do not press the lens release button.
- Do not touch internal portions of the camera.

2 Remove the lens cap.

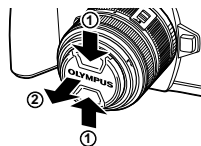

Using lenses with an UNLOCK switch

Retractable lenses with an UNLOCK switch cannot be used while retracted. Turn the zoom ring in the direction of arrow (1) to extend the lens (2).

To store, turn the zoom ring in the direction of arrow (4) while sliding the UNLOCK switch (3).

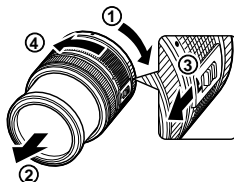

Removing the lens from the camera

While pressing the lens release button, rotate the lens in the direction of the arrow.

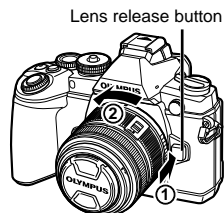

Interchangeable lenses

Read "Interchangeable lenses" (P. 125).

Attaching the flash unit

1 Remove the terminal cover from the flash unit and attach the flash to the camera.

- Slide the flash unit all the way in, stopping when it contacts the back of the shoe and is securely in place.

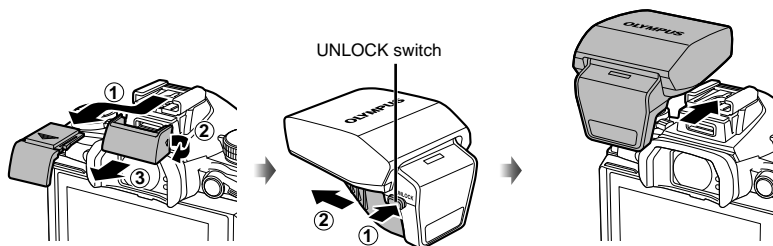

2 To use the flash, raise the flash head.

- Lower the flash head when the flash is not in use.

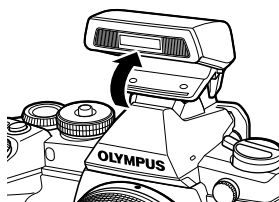

! Cautions

- When not using the accessory port, be sure to attach the cover.

Removing the Flash Unit

Press the UNLOCK switch while removing the flash unit.

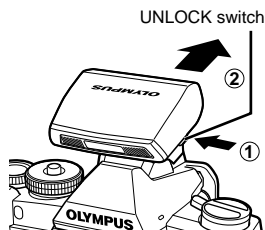

Power on

- 1 Move the ON/OFF lever to the ON position to turn on the camera.
 - When the camera is turned on, the monitor will turn on.
 - To turn off the camera, return the lever to the OFF position.

■ ON/OFF lever

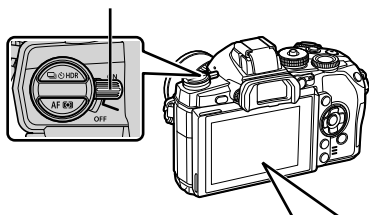

■ Monitor



Battery level

- (green): Camera ready to shoot.
- (green): Low battery
- (blinks red): Charge the battery.

Using the monitor

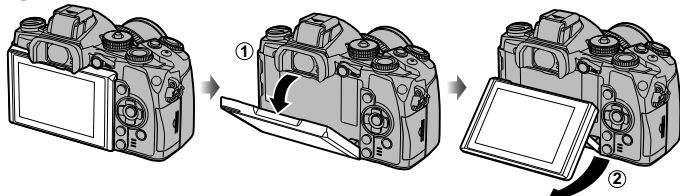

You can adjust the angle of the monitor.

Camera sleep operation

If no operations are performed for a minute, the camera enters “sleep” (stand-by) mode to turn off the monitor and to cancel all actions. The camera activates again when you touch any button (the shutter button, button, etc.). The camera will turn off automatically if left in sleep mode for 4 hours. Turn the camera on again before use.

Setting the date/time

Date and time information is recorded on the card together with the images. The file name is also included with the date and time information. Be sure to set the correct date and time before using the camera.

1 Display the menus.

- Press the MENU button to display the menus.

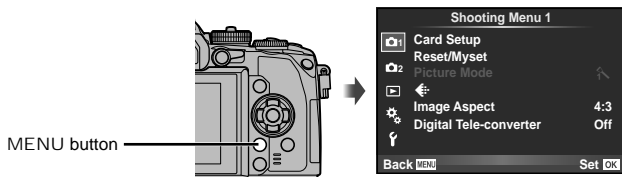

2 Select [0] in the [f] (setup) tab.

- Use Δ ∇ on the arrow pad to select [f] and press \triangleright .
- Select [0] and press \triangleright .



3 Set the date and time.

- Use \triangleleft \triangleright to select items.
- Use Δ ∇ to change the selected item.
- Use Δ ∇ to select the date format.

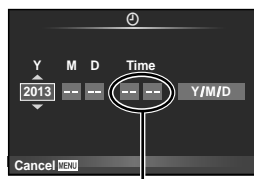

The time is displayed using a 24-hour clock.

4 Save settings and exit.

- Press OK to set the camera clock and exit to the main menu.
- Press the MENU button to exit the menus.

Setting the shooting mode

Use the mode dial to select the shooting mode.

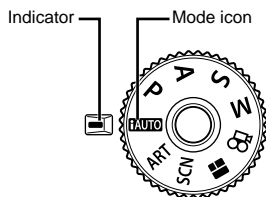

iAUTO	A full auto mode in which the camera automatically optimizes settings for the current scene. The camera does all the work, which is convenient for beginners.
P	Aperture and shutter speed are automatically adjusted for optimal results.
A	You control aperture. You can sharpen or soften background details.
S	You control shutter speed. You can express the motion of moving subjects, or freeze motion without any blur.
M	You control aperture and shutter speed. You can shoot with long exposures for fireworks or other dark scenes.
ART	Select an art filter.
SCN	Select a scene according to the subject.
	You can shoot a PHOTO STORY. Shoot with selected PHOTO STORY type.
	Shoot movies using shutter speed and aperture effects and movie special effects.

First, try taking photographs in full auto mode.

- 1 Press the mode dial lock to release the lock and set the mode dial to **iAUTO**.
 - When the mode dial lock has been pressed down, the mode dial is locked. Each time you press the mode dial lock, it switches between locked/released.

Mode dial lock

The diagram shows the mode dial lock being pressed down, which locks the dial. A double-headed arrow indicates the dial can be rotated in either direction.

Monitor

The LCD monitor displays the following information:

- ISO sensitivity:** AUTO
- WB:** AUTO
- A ± 0**
- G ± 0**
- S-AF**
- ± 0.0**
- SAS AUTO**
- N**
- 23**
- 250 F5.6**
- 01:02:03**
- 1023**

Labels on the monitor display:

- Available recording time:** 01:02:03
- Number of storable still pictures:** 1023
- Shutter speed:** 250
- Aperture value:** F5.6

Selecting a shooting method

With this camera, you can select between two shooting methods: Shooting using the viewfinder and shooting using live view with the monitor. Press the  button to switch between shooting methods.

In addition, you can set various shooting functions using the super control panel, live control, and LV super control panel, depending on the shooting method.

Shooting using the viewfinder

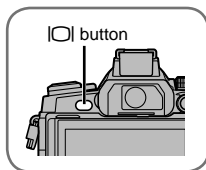

Shooting using live view



■ Monitor

Lights up when you move your eye away from the viewfinder.

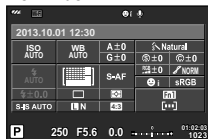

Super control panel



Cursor



When setting shooting functions, if you press the  button, a cursor will appear on the super control panel. Touch the function you want to set.

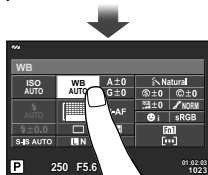

■ Viewfinder

Automatically lights up when your eye moves close. When the viewfinder is lit up, the monitor turns off.



If you press the  button while the viewfinder is lit up, Live Control will be displayed in the viewfinder. (During **FAUTO** mode, a live guide is displayed.)

■ Monitor



Live view display



When setting shooting functions, if you press the  button, live control will be displayed and you can select a function by turning the rear dial.

2 Shooting using the viewfinder

Shooting

Each time you press the  button, you can switch between shooting with the viewfinder and shooting with live view. When shooting with the viewfinder, the super control panel will be displayed on the monitor.

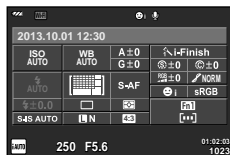
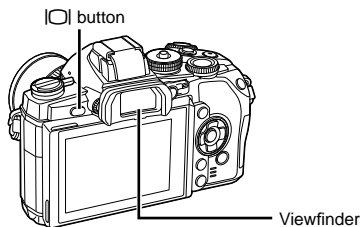

Super control panel

If the display in the viewfinder looks blurry

Look through the viewfinder and rotate the diopter adjustment dial until the display is in sharp focus.

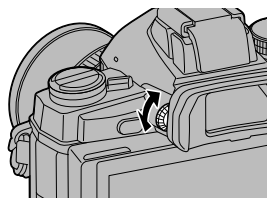

Shooting still pictures

1 Set up the camera and decide on the composition.

- The viewfinder turns on and the monitor turns off automatically when you put your eye to the viewfinder.
- Be careful that your fingers or the camera strap do not obstruct the lens.

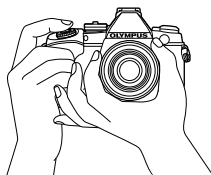

Horizontal grip

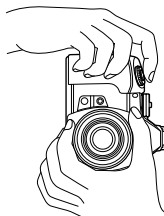

Vertical grip

2 Lightly press the shutter button down to the first position. (Press halfway.)

- The AF confirmation mark (●) will be displayed, and a green frame (AF target) will be displayed in the focus location.

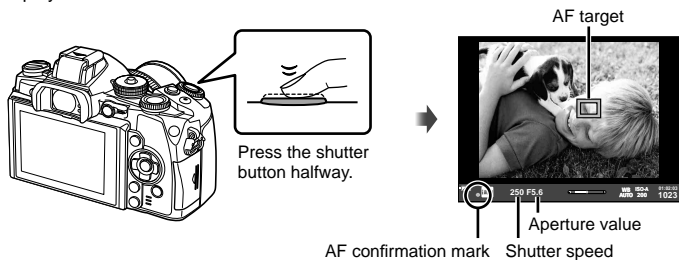

- The ISO sensitivity, shutter speed and aperture value that have been set automatically by the camera are displayed.
- If the AF confirmation mark blinks, the subject is not in focus. (P. 136)

3 Press the shutter button again to take a picture. (Press all the way down.)

- The shutter sounds and the picture is taken.
- The shot image will be displayed on the monitor.

Pressing the shutter button halfway and all the way down

The shutter button has two positions. The act of lightly pressing the shutter button to the first position and holding it there is called “pressing the shutter button halfway,” that of pressing it all the way down to the second position “pressing the shutter button all (or the rest of) the way down.”



⚠ Cautions

- You can change the viewfinder display style. In this manual, [Style 1] is used.
- If the angle of the monitor has been changed, the viewfinder will not light up automatically.
- If you press and hold down the  button, a menu is displayed that allows you to change the settings for automatically lighting up the viewfinder.

Recording movies

You can record movies in all shooting modes except **[]** (PHOTO STORY). First, try recording in full auto mode.

- 1 Set the mode dial to **[i]** **AUTO**.
- 2 Press the **[]** button to begin recording.
 - The image being shot is displayed on the monitor.
 - If you look through the viewfinder, the image being recorded will be displayed.
 - You can change the focus location by touching the screen while recording (P. 27).
- 3 Press the **[]** button again to end recording.
 - When shooting is complete, the super control panel will be displayed on the monitor.

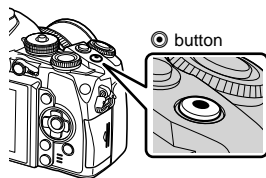

Displayed during recording Recording time

[!] Cautions

- When using a camera with a CMOS image sensor, moving objects may appear distorted due to the rolling shutter phenomenon. This is a physical phenomenon whereby distortion occurs in the filmed image when shooting a fast-moving subject or due to camera shaking. In particular, this phenomenon becomes more noticeable when using a long focal length.
- If the camera is used for extended periods, the temperature of the image pickup device will rise and noise and colored fog may appear in images. Turn off the camera for a short time. Noise and colored fog may also appear in images recorded at high ISO sensitivity settings. If the temperature rises further, the camera will turn off automatically.
- When using a Four Thirds system lens, the AF will not operate while recording movies.

[■] Taking photographs during movie recording

- Press the shutter button during movie recording to pause movie recording and take a photograph. Movie recording restarts after the photograph is taken. Press the **[]** button to end recording. Three files will be recorded to the memory card: the movie footage preceding the photograph, the photograph itself, and the movie footage following the photograph.
- Only one photograph can be taken at a time during movie recording; the self-timer and flash cannot be used.

[!] Cautions

- Image size and quality for photographs are independent of movie frame size.
- The autofocus and metering used in movie mode may differ from that used to take photographs.
- The **[]** button cannot be used to record movies in the following instances:
Multiple exposure (still photography also ends.)/shutter button pressed halfway/during bulb or time photography/sequential shooting/Panorama/SCN mode (e-Portrait, Hand-Held Starlight, 3D)/time lapse shooting

Setting shooting functions

Using the Multi-function button

When framing pictures in the viewfinder, you can adjust settings quickly using the multi-function button. At default settings, the **Fn2** button is assigned the role of the multi-function button.

■ Choosing a function

- 1 Press and hold the **Fn2** button and rotate the dial.
 - The menus are displayed.
- 2 Keep rotating the dial to select the desired function.
 - Release the button when the desired function is selected.

■ Using multifunction options

Press the **Fn2** button. An option selection dialog will be displayed.

[Q] assigned to Fn2 button

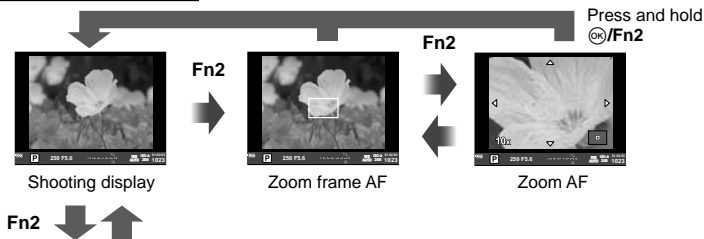

Other option assigned to Fn2 button



Function	Front dial (☺)	Rear dial (☹)
(Highlight and shadow control) (P.49)	Highlight control	Shadow control
(Color Creator) (P.58)	Hue	Saturation
(Zoom frame AF/zoom AF) (P.54)	Zoom frame AF: Exposure compensation Zoom AF: Zoom in or out	
(Image Aspect) (P.69)	Select an option	

Using the super control panel

When shooting using the viewfinder, the super control panel will be displayed on the monitor. Set your main shooting functions using the super control panel.

Super control panel display

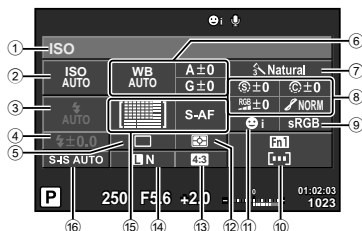

Settings that can be modified using the super control panel

① Currently selected option	⑨ Color space.....P. 95
② ISO sensitivity.....P. 57	⑩ Button function assignmentP. 91, 99
③ Flash mode.....P. 50	⑪ Face priority.....P. 53
④ Flash intensity control.....P. 71	⑫ Metering mode.....P. 72
⑤ Sequential shooting/self-timerP. 55	⑬ Aspect ratio.....P. 69
⑥ White balance.....P. 56	⑭ Record mode.....P. 70
White balance compensation	⑮ AF mode.....P. 73
⑦ Picture mode.....P. 68	⑯ AF target.....P. 52
⑧ SharpnessP. 78	⑰ Image stabilizer.....P. 66
ContrastP. 78	
SaturationP. 78	
GradationP. 78	
B&W FilterP. 78	
Picture toneP. 79	

⚠ Cautions

- Not displayed in SCN, , or modes.

- 1 Press the button.
 - The cursor appears.
- 2 Touch the function you wish to set.
 - The cursor appears over the function you touched.
- 3 Turn the front dial and select a setting value.

Cursor



Notes

- You can display menus for each function by selecting a function and pressing .

3 Shooting using live view

Shooting

You can switch between shooting using the viewfinder and shooting using live view by pressing the  button. When shooting using live view, the subject is displayed on the monitor.

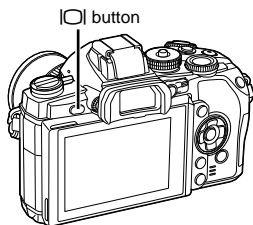

Monitor

Shooting still pictures

- 1 Set up the camera and decide on the composition.
 - Be careful not to cover the lens with a finger or the camera strap.
- 2 Touch the area of the subject you want to focus on.
 - The camera focuses on the area you touched and automatically takes a photograph.
 - The recorded image is displayed on the monitor.



Notes

- You can also use the shutter button to take a photograph, just as you would when shooting using the viewfinder.
- You can also press the shutter button after the camera focuses on the area you touched to take a photograph.  “Using the touch screen” (P. 27)

Recording movies

You can record movies in all shooting modes except **■** (PHOTO STORY). First, try recording in full auto mode.

- 1 Set the mode dial to **FAUTO**.
- 2 Press the **⊙** button to begin recording.
 - You can change the focus location by touching the screen while recording (P. 27).

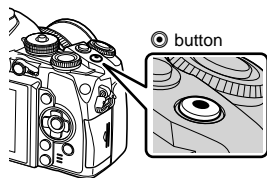

- 3 Press the **⊙** button again to end recording.



Displayed during recording Recording time

⚠ Cautions

- When using a camera with a CMOS image sensor, moving objects may appear distorted due to the rolling shutter phenomenon. This is a physical phenomenon whereby distortion occurs in the filmed image when shooting a fast-moving subject or due to camera shaking. In particular, this phenomenon becomes more noticeable when using a long focal length.
- If the camera is used for extended periods, the temperature of the image pickup device will rise and noise and colored fog may appear in images. Turn off the camera for a short time. Noise and colored fog may also appear in images recorded at high ISO sensitivity settings. If the temperature rises further, the camera will turn off automatically.
- When using a Four Thirds system lens, the AF will not operate while recording movies.

■ Taking photographs during movie recording

- Press the shutter button during movie recording to pause movie recording and take a photograph. Movie recording restarts after the photograph is taken. Press the **⊙** button to end recording. Three files will be recorded to the memory card: the movie footage preceding the photograph, the photograph itself, and the movie footage following the photograph.
- Only one photograph can be taken at a time during movie recording; the self-timer and flash cannot be used.

⚠ Cautions

- Image size and quality for photographs are independent of movie frame size.
- The autofocus and metering used in movie mode may differ from that used to take photographs.
- The **⊙** button cannot be used to record movies in the following instances:
Multiple exposure (still photography also ends.)/shutter button pressed halfway/during bulb or time photography/sequential shooting/Panorama/SCN mode (e-Portrait, Hand-Held Starlight, 3D)/time lapse shooting





Using the touch screen

When shooting using live view, touch panel functions can be used.

Selecting a focusing method

You can focus and shoot by tapping the monitor.

Tap  to cycle through touch screen settings.

-  Touch screen operations disabled.
-  Tap a subject to focus and automatically release the shutter. This function is not available in  mode.
-  Tap to display an AF target and focus on the subject in the selected area. You can use the touch screen to choose the position and size of the focus frame. Photographs can be taken by pressing the shutter button.

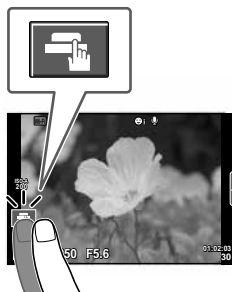

■ Previewing Your Subject ()

1 Tap the subject in the display.

- An AF target will be displayed.
- Use the slider to choose the size of the frame.



2 Use the slider to choose the size of the target frame, and then tap to zoom in on the subject of the target frame.

- Use your finger to scroll the display when the picture is zoomed in.
- Tap  to cancel the zoom display.

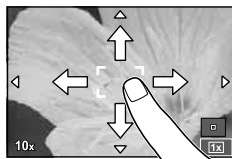

Cautions

- When using a Four Thirds system lens, the range within which auto focus is possible decreases. If you touch the screen outside of the possible range, the camera shoots without using AF.

Using the wireless LAN function

You can connect the camera to a smartphone and control the camera over Wi-Fi. To use this function, you must have the relevant app installed on the smartphone.

 "Using the camera wireless LAN function" (P. 119),
"Things you can do with OI.Share" (P. 121)



Setting shooting functions

Using live guides

Live guides are available in iAUTO (iAUTO) mode. While iAUTO is a full auto mode, live guides make it easy to access a variety of advanced photographic techniques.

- 1 Set the mode dial to **iAUTO**.
- 2 Touch the tab to display live guides.
 - Select a guide item and touch it to set that item.

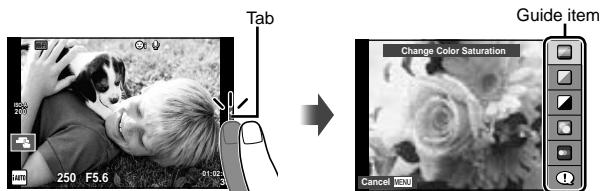

- 3 Use your finger to position the sliders.

- Tap **OK** to enter the setting.
- To cancel the live guide setting, tap **MENU** on the screen.
- If [Shooting Tips] is selected, highlight an item and press **OK** to view a description.
- The effect of the selected level is visible in the display. If [Blur Background] or [Express Motions] is selected, the display will return to normal, but the selected effect will be visible in the final photograph.

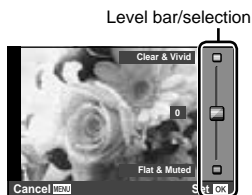

- 4 Shoot.
 - To clear the live guide from the display, press the MENU button.

Notes

- Live guides can also be used when shooting using the viewfinder. When shooting using the viewfinder, settings are made using the dial and buttons. If you press the **OK** button, the live guide is displayed, and the rear dial is used to select items and operate the sliders.

Cautions

- If [RAW] is currently selected for image quality, image quality will automatically be set to [L+N+RAW].
- Live guide settings are not applied to the RAW copy.
- Pictures may appear grainy at some live guide setting levels.
- Changes to live guide setting levels may not be visible in the monitor.
- Frame rates drop when [Blurred Motion] is selected.
- The flash cannot be used with the live guide.
- Changes to live guide options cancel previous changes.
- Choosing live guide settings that exceed the limits of the camera exposure meters may result in pictures that are over or underexposed.

Using live control

When shooting using live view, live control can be used to set functions in **P**, **A**, **S**, **M**, **☺**, and **■** modes. Using live control allows you to preview the effects of different settings in the monitor.



■ Available settings

Image stabilizer	P. 66	Record mode	P. 70
Picture mode	P. 68	Flash mode	P. 50
Scene mode	P. 45	Flash intensity control.....	P. 71
Art filter mode	P. 44	Metering mode.....	P. 72
☺ mode	P. 69	AF mode	P. 73
White balance.....	P. 56	ISO sensitivity.....	P. 57
Sequential shooting/self-timer	P. 55	Face priority.....	P. 53
Aspect ratio.....	P. 69	Movie sound record.....	P. 74

1 Press **OK** to display the live control.

- To hide the live control, press **OK** again.

2 Use the rear dial to select the settings, use the front dial to change the selected setting, and press **OK**.

- The selected settings take effect automatically if no operations are performed for about 8 seconds.

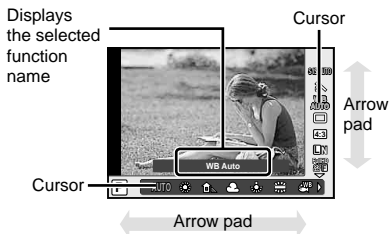

⚠ Cautions

- Some items are not available in some shooting modes.

📖 Notes

- Live control can also be used when shooting using the viewfinder. If you press the **OK** button during viewfinder display, live control will be displayed in the viewfinder. If the viewfinder is switched off while shooting is in progress, live control will also be canceled.

4 Viewing photographs and movies



Viewing photographs and movies

1 Press the  button.

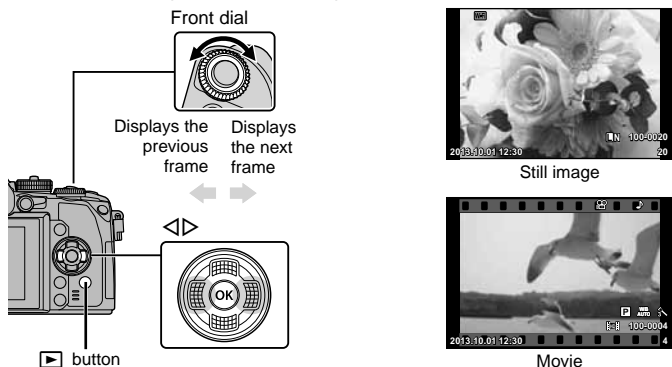
- Your most recent photograph or movie will be displayed.
- Select the desired photograph or movie using the front dial or arrow pad.





Index display/Calendar display

- To start index playback, turn the rear dial to  during single-frame playback. To start calendar playback, turn the dial a little further.
- Turn the rear dial to  to return to single-frame playback.



Viewing still images

Close-up playback

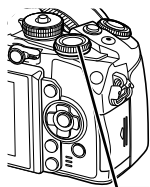

In single-frame playback, turn the rear dial to  to zoom in. Turn to  to return to single-frame playback.



Rear dial





Watching movies

Select a movie and press the  button to display the playback menu. Select [Movie Play] and press the  button to begin playback. To interrupt movie playback, press MENU.



Volume

Volume can be adjusted by pressing  or  during single-frame and movie playback.



Protecting images

Protect images from accidental deletion. Display an image you wish to protect and press the **AEL/AFL** button; a  (protect) icon will appear on the image. Press the **AEL/AFL** button again to remove protection.

You can also protect multiple selected images.



 (protect) icon



Cautions



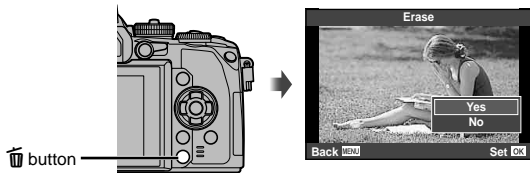

- Formatting the card erases all images even if they have been protected.

Erasing images

Display an image you want to delete and press the  button. Select [Yes] and press the  button.



Selecting images

Select the image. You can also select multiple images for protection or deletion. Press the  button to select an image; a  icon will appear on the image. Press the  button again to cancel the selection. Press  to display the delete or protect selection menu.



Using the touch screen

You can use the touch panel to manipulate images.



■ Full-frame playback

Viewing additional images

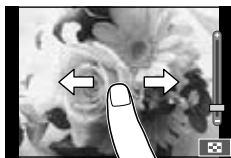
- Slide your finger to the left to view later frames, right to scroll view earlier frames.





Playback zoom

- Slide the bar up or down to zoom in or out.
- Use your finger to scroll the display when the picture is zoomed in.
- Tap  to display index playback. Tap  again for calendar playback.



■ Index/Calendar Playback

Page ahead/Page back

- Slide your finger up to view the next page, down to view the previous page.
- Use  or  to choose the number of images displayed.
- Tap  several times to return to single-frame playback.

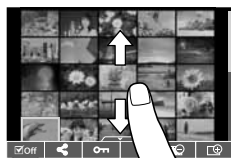





Viewing images

- Tap an image to view it full frame.

Selecting and protecting images

In single-frame playback, lightly touch the screen to display the touch menu. You can then perform the desired operation by touching the icons in the touch menu.

	Select an image. You can select multiple images for protection.
	You can set the images you wish to share over Wi-Fi connection.  [Share Order] (P. 62)
	Protects an image.

⚠ Cautions

- The situations in which touch screen operations are not available include the following.
 - Panorama/3D/e-portrait/multiple exposure/during bulb or time photography/one-touch white balance dialog/when buttons or dials are in use
- Do not touch the display with your fingernails or other sharp objects.
- Gloves or monitor covers may interfere with touch screen operation.
- You can also use the touch screen with the ART, SCN and  menus. Tap an icon to select it.

5 Basic operations

Information displays while shooting

Viewfinder display when shooting using the viewfinder

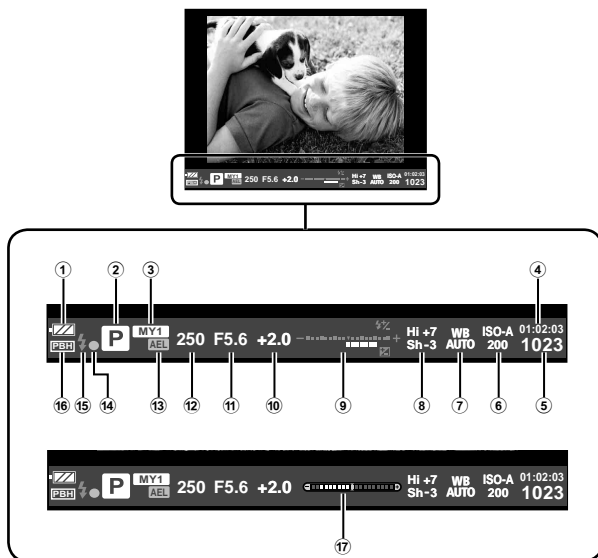

- ① Battery check
 - Lit up: Ready for use.
 - Lit up: Battery is running low.
 - Blinks (red) : Charging required.
- ② Shooting mode.....P. 18, 38–47
- ③ MysetP. 77
- ④ Available recording time
- ⑤ Number of storable still pictures ...P. 124
- ⑥ ISO sensitivityP. 57
- ⑦ White balanceP. 56
- ⑧ Highlight and shadow control.....P. 49
- ⑨ Top: Flash intensity controlP. 71
Bottom: Exposure compensation indicatorP. 49
- ⑩ Exposure compensation value.....P. 49
- ⑪ Aperture valueP. 38–41
- ⑫ Shutter speedP. 38–41
- ⑬ AE Lock (AEL)P. 49
- ⑭ AF confirmation mark.....P. 21
- ⑮ FlashP. 50
(blinks: charging in progress)
- ⑯ PBH (displayed when camera is receiving power from power battery holder).....P. 129
- ⑰ Level gauge (displayed by pressing the shutter button down halfway).....P. 37

You can change the viewfinder display style. In this manual, [Style 1] is used.

[Built-in EVF Style] (P. 97)

Monitor display when shooting using live view

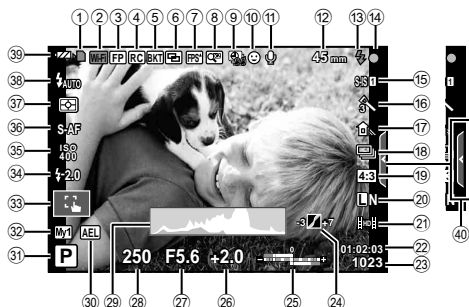

- | | | |
|--|--|---|
| ① Card write indicator.....P. 13 | ②③ Wi-Fi connection.....P. 27, 119 | ②③ Number of storable still pictures ...P. 124 |
| ② Super FP flash.....P. 130 | ④ RC mode.....P. 131 | ②④ Highlight&Shadow Control.....P. 49 |
| ③ Auto bracket/HDR(HDR).....P. 80/P. 59 | ⑤ Multiple exposure.....P. 82 | ②⑤ Top: Flash intensity controlP. 71 |
| ④ Multiple exposure.....P. 82 | ⑥ High frame rate.....P. 93 | Bottom: Exposure compensation indicator.....P. 49 |
| ⑤ Digital Tele-converter.....P. 84 | ⑦ Digital Tele-converter.....P. 84 | ②⑥ Exposure compensation value.....P. 49 |
| ⑥ Time lapse shooting.....P. 83 | ⑧ Face priority.....P. 53 | ②⑦ Aperture value.....P. 38–41 |
| ⑦ Face priority.....P. 53 | ⑨ Movie sound.....P. 74 | ②⑧ Shutter speed.....P. 38–41 |
| ⑧ Focal length/Internal temperature warning °C/°F.....P. 128/P. 139 | ⑩ Myset.....P. 77 | ②⑨ Histogram.....P. 37 |
| ⑨ Flash.....P. 50 | ⑪ Shooting mode.....P. 18, 38–47 | ③① AE Lock.....P. 49 |
| (blinks: charging in progress, lights up: charging completed) | ⑫ Shooting using touch screen operations.....P. 27 | ③② Shooting mode.....P. 18, 38–47 |
| ⑩ AF confirmation mark.....P. 21 | ⑬ Flash intensity control.....P. 71 | ③③ Myset.....P. 77 |
| ⑪ Image stabilizer.....P. 66 | ⑭ ISO sensitivity.....P. 57 | ③④ Shooting using touch screen operations.....P. 27 |
| ⑫ Art filter.....P. 44 | ⑮ AF mode.....P. 73 | ③⑤ Flash intensity control.....P. 71 |
| Scene mode.....P. 45 | ⑯ Metering mode.....P. 72 | ③⑥ ISO sensitivity.....P. 57 |
| Picture mode.....P. 68 | ⑰ Flash mode.....P. 50 | ③⑦ AF mode.....P. 73 |
| ⑬ White balance.....P. 56 | ⑱ Battery check | ③⑧ Metering mode.....P. 72 |
| ⑭ Sequential shooting/self-timer.....P. 55 | Lit up (green): Ready for use (displayed for about ten seconds after the camera is turned on.) | ③⑨ Flash mode.....P. 50 |
| ⑮ Aspect ratio.....P. 69 | Lit up (green): Battery is running low. | ③⑩ Battery check |
| ⑯ Record mode (still images).....P. 70 | Blinks (red): Charging required | ③⑪ Ready for use (displayed for about ten seconds after the camera is turned on.) |
| ⑰ Record mode (movies).....P. 71 | ④① Live guide recall.....P. 28 | ③⑫ Battery is running low. |
| ⑱ Available recording time | | ③⑬ Charging required |

Switching the information display

You can switch the information displayed in the monitor during shooting using the INFO button.

- When shooting using the viewfinder

Monitor display

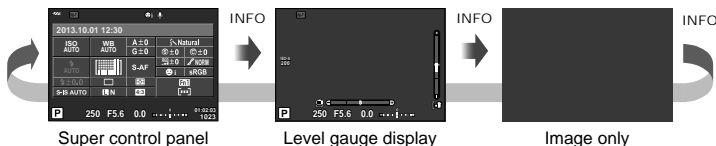

Viewfinder display

Can be switched while looking through the viewfinder.

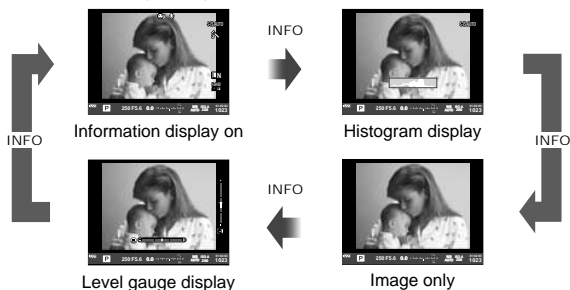

- When shooting using Live View

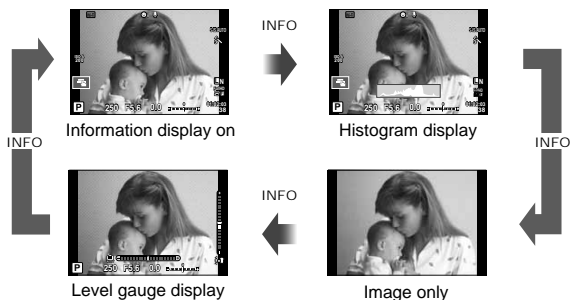

Histogram display

Display a histogram showing the distribution of brightness in the image. The horizontal axis gives the brightness, the vertical axis the number of pixels of each brightness in the image. Areas above the upper limit at shooting are displayed in red, those below the lower limit in blue, and the area metered using spot metering in green.

Level gauge display

Indicate the orientation of the camera. The "tilt" direction is indicated on the vertical bar and the "horizon" direction on the horizontal bar. Use the indicators on the level gauge as a guide.

Using the shooting modes

“Point-and-shoot” photography (P program mode)

In mode **P**, the camera automatically adjusts shutter speed and aperture in response to subject brightness. Set the mode dial to **P**.



When shooting using the viewfinder



Shooting mode

When shooting using live view

Shutter speed

Aperture value

- The functions you can set with the dials depend on the position of the lever.

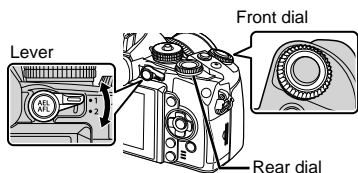

Dial	Position of the lever	
	1	2
	Exposure compensation	ISO
	Program shift	White balance

- The shutter speed and aperture selected by the camera are displayed.
- The shutter speed and aperture displays will blink if the camera is unable to achieve optimal exposure.

Warning display example (blinking)	Status	Action
	The subject is too dark.	<ul style="list-style-type: none"> Use the flash.
	The subject is too bright.	<ul style="list-style-type: none"> The metered range of the camera is exceeded. A commercially available ND filter (for adjusting the amount of light) is required.

- The aperture value at the moment when its indication blinks varies with the lens type and focal length of the lens.
- When using a fixed [ISO] setting, change the setting. [ISO] (P. 57)

Program shift (Ps)

In **P** and ART modes, you can choose different combinations of aperture value and shutter speed without altering exposure. “s” appears next to the shooting mode during program shift. To cancel program shift, turn the rear dial until “s” is no longer displayed.

⚠ Cautions

- Program shift is not available when you are using a flash.



Program shift

Choosing aperture (A aperture-priority mode)

In mode **A**, you choose the aperture and let the camera automatically adjust shutter speed for optimal exposure. Rotate the mode dial to **A**.

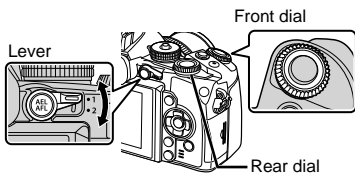

Dial	Position of the lever	
	1	2
	Exposure compensation	ISO
	Aperture value	White balance

- Larger apertures (lower F-numbers) decrease depth of field (the area in front of or behind the focus point that appears to be in focus), softening background details. Smaller apertures (higher F-numbers) increase depth of field.



Aperture value

When shooting using live view

Setting the aperture value

Reducing aperture value ←

→ Increasing aperture value

F2 ← F3.5 ← **F5.6** → F8.0 → F16

- The shutter speed display will blink if the camera is unable to achieve optimal exposure.

Warning display example (blinking)	Status	Action
F5.6	The subject is underexposed.	<ul style="list-style-type: none"> • Decrease the aperture value.
F5.6	The subject is overexposed.	<ul style="list-style-type: none"> • Increase the aperture value. • If the warning display does not disappear, the metered range of the camera is exceeded. A commercially available ND filter (for adjusting the amount of light) is required.

- The aperture value at the moment when its indication blinks varies with the lens type and focal length of the lens.
- When using a fixed [ISO] setting, change the setting. [ISO] (P. 57)

Preview function

You can preview the focus range (depth of field). While pressing the preview button, the aperture is stopped down to the set aperture value.

Choosing shutter speed (S shutter-priority mode)

In mode **S**, you choose the shutter speed and let the camera automatically adjust aperture for optimal exposure. Rotate the mode dial to **S**.

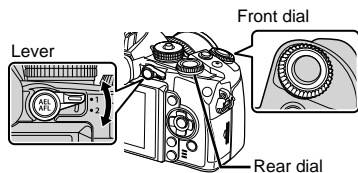

Dial	Position of the lever	
	1	2
	Exposure compensation	ISO
	Shutter speed	White balance

- A fast shutter speed can freeze a fast action scene without any blur. A slow shutter speed will blur a fast action scene. This blurring will give the impression of dynamic motion.



Shutter speed

When shooting using live view

Setting the shutter speed

Slower shutter speed ←

→ Faster shutter speed

2" ← 1" ← 15 ← **60** → 100 → 400 → 1000

- The aperture value display will blink if the camera is unable to achieve optimal exposure.

Warning display example (blinking)	Status	Action
2000 F2.8	The subject is underexposed.	<ul style="list-style-type: none"> Set the shutter speed slower.
125 F22	The subject is overexposed.	<ul style="list-style-type: none"> Set the shutter speed faster. If the warning display does not disappear, the metered range of the camera is exceeded. A commercially available ND filter (for adjusting the amount of light) is required.

- The aperture value at the moment when its indication blinks varies with the lens type and focal length of the lens.
- When using a fixed [ISO] setting, change the setting. [ISO] (P. 57)

Choosing aperture and shutter speed (M manual mode)

In mode **M**, you choose both the aperture and the shutter speed. At a speed of BULB, the shutter remains open while the shutter button is pressed. Set the mode dial to **M**.

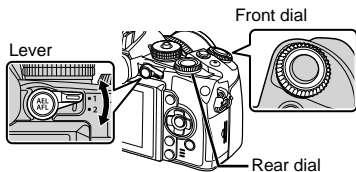

Dial	Position of the lever	
	1	2
	Aperture value	ISO
	Shutter speed	White balance

- Shutter speed can be set to values between 1/8000 and 60 seconds or to [BULB] or [LIVE TIME].

! Cautions

- Exposure compensation is not available in **M** mode.

Choosing when the exposure ends (bulb/time photography)

Use for night landscapes and fireworks. Shutter speeds of [BULB] and [LIVE TIME] are available in mode **M**.

Bulb photography (BULB): The shutter remains open while the shutter button is pressed. The exposure ends when the shutter button is released.

Time photography (TIME): The exposure begins when the shutter button is pressed all the way down. To end the exposure, press the shutter button all the way down again.

- When using BULB or TIME, screen brightness is varied automatically.
- When using [LIVE TIME], the progress of the exposure will be displayed in the monitor during shooting. The display can also be refreshed by pressing the shutter button halfway.
- [Live BULB] (P. 94) can be used to display the image exposure during bulb photography.

! Cautions

- ISO sensitivity can be set to a value up to ISO 1600 for live bulb and live time photography.
- To reduce camera blur during long exposures, mount the camera on a tripod and use a remote cable (P. 133).
- The following features are not available during long exposures:
Sequential shooting/self-timer shooting/AE bracket shooting/image stabilizer/
flash bracketing/multiple exposure*
* An option other than [Off] is selected for [Live BULB] or [Live TIME] (P. 94).
- Even when [Noise Reduct.] is in use, noise may be noticeable in the image displayed on the monitor during shooting.

Noise in images

While shooting at slow shutter speeds, noise may appear on screen. These phenomena occur when the temperature rises in the image pickup device or image pickup device internal drive circuit, causing current to be generated in those sections of the image pickup device that are not normally exposed to light. This can also occur when shooting with a high ISO setting in a high-temperature environment. To reduce this noise, the camera activates the noise reduction function. [Noise Reduct.] (P. 93)

Using movie mode (🎥)

Movie mode (🎥) can be used to film movies with special effects.

You can create movies that take advantage of the effects available in still photography mode. Use live control to select the settings. 🖱️ "Adding effects to a movie" (P. 69)
You can also apply an after-image effect or zoom in on an area of the image during movie recording.

Adding effects to a movie [Movie Effect]

- 1 Rotate the mode dial to 🎥.
- 2 Press the ⏻ button to begin recording.
 - Press the ⏻ button again to end recording.
- 3 Touch the on-screen icon of the effect you wish to use.
 - You can also use the buttons displayed on icons.

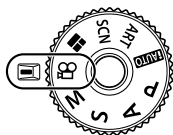

	Multi Echo	Apply an after-image effect. After-images will appear behind moving objects.
	One Shot Echo	An after-image will appear for a short time after you press the button. The after-image will disappear automatically after a while.
	Art Fade	Film with the selected picture mode effect. The fade effect is applied to the transition between scenes.
	Movie Tele-converter	Zoom in on an area of the image without using the lens zoom. Zoom in on the selected position of the image even while the camera is kept fixed.

Multi Echo

Touch the icon to apply the effect. Touch again to cancel the effect.

One Shot Echo

Each touch of the icon adds to the effect.

Art Fade

Touch the icon. Touch the picture mode you wish to use. The effect will be applied when you release your finger.

Movie Tele-converter

- 1 Touch the icon to display the zoom frame.
 - You can change the position of the zoom frame by touching the screen or using $\Delta \nabla \langle \rangle$.
 - Press and hold \odot to return the zoom frame to a central position.
- 2 Touch Fn2 or press the Fn2 button to zoom in on the area in the zoom frame.
 - Touch Fn0 or press the Fn2 button to return to the zoom frame.
- 3 Touch XOK or press \odot to cancel the zoom frame and exit Movie tele-converter mode.

Cautions

- The frame rate will drop slightly during recording.
- The 2 effects cannot be applied simultaneously.
- Use a memory card with an SD speed class of 6 or better. Movie recording may end unexpectedly if a slower card is used.
- Taking a photograph during movie recording cancels the effect; the effect does not appear in the photograph.
- [e-Portrait], [Diorama] and [Color Creator] cannot be used at the same time as Art Fade.
- Movie Tele-converter cannot be used when [Picture Mode] is set to [ART].
- The sound of touch operations and button operations may be recorded.
- Besides using touch operations, you can apply effects using the buttons corresponding to the displayed icons.

Using art filters

1 Rotate the mode dial to ART.

- A menu of art filters will be displayed. Select a filter using Δ / ∇ .
- Press \odot or press the shutter button halfway to select the highlighted item and exit the art filter menu.

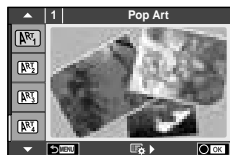

■ Types of art filters

- | | |
|------------------|--------------------------|
| Pop Art | Cross Process |
| Soft Focus | Gentle Sepia |
| Pale&Light Color | Dramatic Tone |
| Light Tone | Key Line |
| Grainy Film | Watercolor |
| Pin Hole | ART BKT (ART bracketing) |
| Diorama | |

2 Shoot.

- To choose a different setting, press \odot to display the art filter menu.

ART bracketing

When one shot is taken, images are recorded for each selected art filter. Press \triangleright to choose filters.

Art effects

Art filters can be modified and effects can be added. Pressing \triangleright in the art filter menu displays additional options.

Modifying filters

Option I is the original filter, while options II and on add effects that modify the original filter.

Adding effects*

Soft focus, pin-hole, frames, white edges, starlight, filter, tone, blur

* The effects available vary with the selected filter.

! Cautions

- If [RAW] is currently selected for image quality, image quality will automatically be set to [LN+RAW]. The art filter will be applied to the JPEG copy only.
- Depending on the subject, tone transitions may be ragged, the effect may be less noticeable, or the image may become more "grainy."
- Some effects may not be visible in live view or during movie recording.
- Playback may differ according to the filters, effects, or movie quality settings applied.

Shooting in scene mode

1 Rotate the mode dial to SCN.

- A menu of scene menu will be displayed. Select a scene using Δ / ∇ .
- Press \odot or press the shutter button halfway to select the highlighted item and exit the scene menu.



■ Types of scene modes

- | | |
|---------------------|------------------|
| Portrait | Macro |
| e-Portrait | Nature Macro |
| Landscape | Candle |
| Landscape+Portrait | Sunset |
| Sport | Documents |
| Hand-Held Starlight | Panorama (P. 46) |
| Night Scene | Fireworks |
| Night+Portrait | Beach & Snow |
| Children | Fisheye Effect |
| High Key | Wide-Angle |
| Low Key | Macro |
| DIS Mode | 3D Photo |

2 Shoot.

- To choose a different setting, press \odot to display the scene menu.

! Cautions





- In [e-Portrait] mode, two images are recorded: an unmodified image and a second image to which [e-Portrait] effects have been applied. Recording may take some time. In addition, when the image quality mode is [RAW], the image is recorded in RAW+JPEG.
- [Fisheye Effect], [Wide-Angle], and [Macro] are for use with optional converter lenses.
- Movies cannot be recorded in [e-Portrait], [Hand-Held Starlight], [Panorama], or [3D Photo] mode.
- In [Hand-Held Starlight], 8 frames are shot at one time and then combined. When the image quality mode is [RAW], a JPEG image is combined with the first RAW image and recorded in RAW+JPEG.
- [3D Photo] is subject to the following limitations.
 - [3D Photo] can be used only with a 3D lens.
 - The camera monitor cannot be used to playback images in 3D. Use a device that supports 3D display.
 - Focus is locked. In addition, flash and self-timer also cannot be used.
 - Image size is fixed at 1920 × 1080.
 - RAW photography is not available.
 - Frame coverage is not 100%.

Taking panoramas

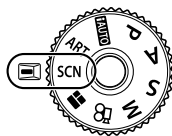
If you have installed the supplied computer software, you can use it to join pictures together to form a panorama.  "Connecting the camera to a computer and a smartphone" (P. 116)

- 1 Rotate the mode dial to SCN.





- 2 Select [Panorama] and press .
- 3 Use     to choose a pan direction.
- 4 Take a picture, using the guides to frame the shot.
 - Focus, exposure, and other settings are fixed at the values for the first shot.

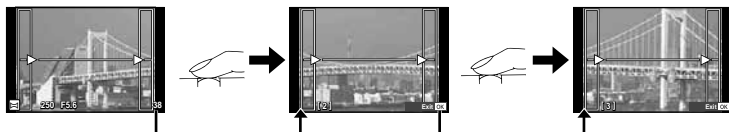

- 5 Take the remaining images, framing each shot so that the guides overlap with the previous picture.





- A panorama may include up to 10 images. A warning indicator () is displayed after the tenth shot.

- 6 After taking the last shot, press  to end the series.

Cautions

- During panorama shooting, the image previously taken for position alignment will not be displayed. With the frames or other markers for display in the images as a guide, set the composition such that the edges of the overlapping images overlap within the frames.



Notes

- Pressing  before shooting the first frame returns to the scene mode selection menu. Pressing  in the midst of shooting ends the sequence of panorama shooting, and allows you to continue with the next one.

Using PHOTO STORY

1 Rotate the mode dial to .

- A PHOTO STORY menu will be displayed.





	Standard
	Speed
	Fun Frames



2 Use Δ ∇ to choose the theme of the PHOTO STORY.

- You can choose different effects, number of frames and aspect ratios for each theme. You can also change the aspect ratio, the division pattern and the frame effect of individual images.

Changing between variations

	Original PHOTO STORY
  	PHOTO STORY with effects and aspect ratios changed from the original PHOTO STORY. The number of images and arrangement of image regions can be altered for each theme of the PHOTO STORY.

- You can change the frame color and frame surrounding effect in each variation.
- Every theme and variation provides a different PHOTO STORY.

3 After finishing the settings, press .



- The monitor switches to PHOTO STORY display.
- The subject of current frame is displayed in live view.
- Touch any of the masked frames to switch the masked frame to the current frame.
- Press the MENU button to change the theme.

4 Shoot an image for the first frame.

- The image you have shot is displayed in the first frame.



5 Shoot an image for the next frame.

- View and shoot the subject for the next frame.
- Press  to cancel the image in the directly preceding frame and retake the shot.
- Touch any frame to cancel the image in it and retake the shot. Touch the frame, and then touch .



Shot image

Next frame (Live view display)

- 6** Once you have shot all the frames, press  to save the image.
- Press the MENU button, and you can select other themes.

Notes

- During the shooting of a PHOTO STORY, the following operations are available.
Exposure compensation/Program shift/Flash shooting (except when the theme is [Speed].)/Live control settings

Cautions

- If the camera is turned off during shooting, all the data for images up to that point is cancelled and nothing is recorded on the memory card.
- If [RAW] is currently selected for image quality, image quality will automatically be set to [L+N+RAW]. The PHOTO STORY image is saved as JPEG and the images in the frames as RAW. RAW images are saved in [4:3].
- From among the [AF Mode], [S-AF], [MF] and [S-AF+MF] can be set. Also, the AF target is fixed to a single central point.
- The metering mode is fixed to digital ESP metering.
- The following operations are not available in PHOTO STORY mode.
MENU display/Movie/Sequential shooting/Self timer/INFO display/Face priority AF/Digital Tele-converter/Picture mode
- The following button operations are disabled.
Fn1/Fn2/INFO etc.
- During the shooting of a PHOTO STORY, the camera will not go into sleep mode.

Commonly used shooting options

Controlling exposure (exposure compensation)

Rotate the front dial to choose exposure compensation. Choose positive (“+”) values to make pictures brighter, negative (“-”) values to make pictures darker. Exposure can be adjusted by ± 5.0 EV.



! Cautions

- Exposure compensation is not available in **FAUTO**, **M**, or SCN mode.
- The viewfinder and live view display can only be changed up to ± 3.0 EV. If the exposure exceeds ± 3.0 EV, the exposure bar will begin flashing.
- Movies can be corrected in a range up to ± 3.0 EV.

Changing the brightness of highlights and shadows

When the multi-function button is set to [Highlight&Shadow Control], a setting screen will be displayed when you press the Fn2 button. Adjust the shadow using the rear dial and the highlight using the front dial.

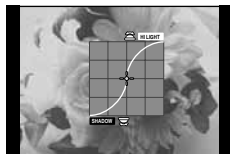

Locking the exposure (AE Lock)

You can lock just the exposure by pressing the AEL/AFL button. Use this when you want to adjust the focus and exposure separately or when you want to shoot several images at the same exposure.

- If you press the AEL/AFL button once, the exposure is locked and **AEL** is displayed.
🔊 “AEL/AFL” (P. 98)
- Press the AEL/AFL button once again to release the AE Lock.

! Cautions

- The lock will be released if you operate the mode dial, MENU button, or **OK** button.

Using a flash (flash photography)

The flash can be set manually as required. The flash can be used for flash photography in a variety of shooting conditions.

- 1 Attach the flash to the camera and raise the light-emitting unit.
 -  "Attaching the flash unit" (P. 15)

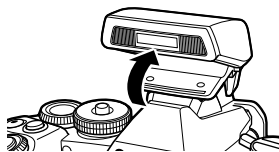

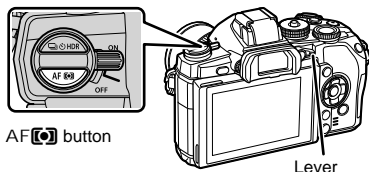

- 2 Set the lever to position 2 and press the AF  button.









AF  button

Lever

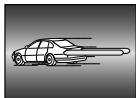

When shooting using live view

- 3 Select a setting using the rear dial and press the  button.
 - The options available and the order in which they are displayed vary depending on the shooting mode.  "Flash modes that can be set by shooting mode" (P. 51)

 AUTO	Auto flash	The flash fires automatically in low light or backlight conditions.
	Fill-in flash	The flash fires regardless of the light conditions.
	Flash off	The flash does not fire.
	Red-eye reduction flash	This function allows you to reduce the red-eye phenomenon. In S and M modes, the flash always fires.
	Slow synchronization (1st curtain)	Slow shutter speeds are used to brighten dimly-lit backgrounds.
	Slow synchronization (1st curtain)/Red-eye reduction flash	Combines slow synchronization with red-eye reduction.
 2nd Curtain	Slow synchronization (2nd curtain)	The flash fires just before the shutter closes to create trails of light behind moving light sources. 
  etc.	Manual	For users who prefer manual operation. If you press the INFO button, you can use the dial to adjust the flash level.

- 4 Press the shutter button all the way.

⚠ Cautions

- In [] (Red-eye reduction flash), after the pre-flashes, it takes about 1 second before the shutter is released. Do not move the camera until shooting is complete.
- [] (Red-eye reduction flash) may not work effectively under some shooting conditions.
- When the flash fires, the shutter speed is set to 1/320 sec. or slower. When shooting a subject against a bright background with the fill-in flash, the background may be overexposed.

Flash modes that can be set by shooting mode

Shooting mode	LV super control panel	Flash mode	Flash timing	Conditions for firing the flash	Shutter speed limit
P/A		Auto flash	1st curtain	Fires automatically in dark/backlit conditions	1/30 sec. – 1/320 sec.*
		Auto flash (red-eye reduction)			
		Fill-in flash			
		Flash off	—	—	—
	SLOW	Slow synchronization (red-eye reduction)	1st curtain	Fires automatically in dark/backlit conditions	60 sec. – 1/320 sec.*
	SLOW	Slow synchronization (1st curtain)			
SLOW2	Slow synchronization (2nd curtain)	2nd curtain			
S/M		Fill-in flash	1st curtain		
		Fill-in flash (red-eye reduction)			
		Flash off	—	—	—
	2nd-C	Fill-in flash/Slow synchronization (2nd curtain)	2nd curtain	Always fires	60 sec. – 1/320 sec.*

- AUTO, can be set in **FAUTO** mode.

* 1/250 sec. when using an separately sold external flash unit

Minimum range

The lens may cast shadows over objects close to the camera, causing vignetting, or be too bright even at minimum output.

Lens	Approximate distance at which vignetting occurs
14–42 mm	0.25 m
17 mm	0.25 m
40–150 mm	0.9 m
14–150 mm	0.5 m
12–50 mm	0.45 m
12–40 mm	3.2 m (when focal length is 12 mm)
	0.7 m (when focal length is 14 mm or above)

- External flash units can be used to prevent vignetting. To prevent photographs from being overexposed, select mode **A** or **M** and choose a high f-number, or reduce ISO sensitivity.

Choosing a focus target (AF Area)

Choose which of the 81 autofocus targets will be used for autofocus.

- 1 Press the arrow pad or Fn1 button to display the AF targets.
- 2 Rotate the dial to choose the AF position.
 - "All targets" mode is restored if you move the cursor off the screen.

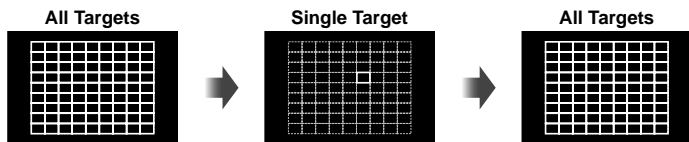

The camera automatically chooses from the full set of focus targets.

Select the focus target manually.

Differences in target display depending on lens

The target display will differ depending on the lens you are using.

When using a Micro Four Thirds system lens, 81 AF targets will be displayed.

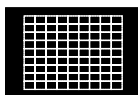

When using a Four Thirds system lens, 37 AF targets will be displayed.



Setting the AF target

You can change the target selection method and target size. You can also select Face priority AF (P. 53).

- 1 Press the INFO button during AF target selection and choose a selection method using Δ / ∇ .

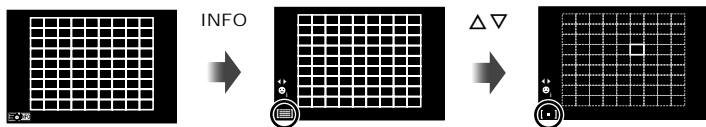

(All Targets)	The camera automatically selects all AF targets.
(Single Target)	You select a single AF target.
(Small Target)	The AF target can be reduced in size.
(Group Target)	The camera automatically chooses from the targets in the selected group.

ⓘ Cautions

- Reverts to "Single Target" when shooting movies.

Face priority AF/pupil detection AF

The camera detects faces and adjusts focus and digital ESP.

- 1 Press the Fn1 button to display the AF target.
- 2 Press the INFO button.
 - You can change the AF target selection method.
- 3 Use \triangleleft / \triangleright to select an option and press \odot .

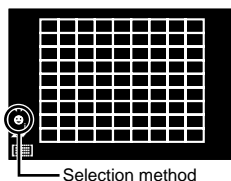

OFF Face Priority Off	Face priority off.
Face Priority On	Face priority on.
Face & Eye Priority On	The autofocus system selects the pupil of the eye closest to the camera for face-priority AF.
Face & R. Eye Priority On	The autofocus system selects the pupil of the eye on the right for face-priority AF.
Face & L. Eye Priority On	The autofocus system selects the pupil of the eye on the left for face-priority AF.

- 4 Point the camera at your subject.
 - When shooting using the viewfinder, look through the viewfinder.
 - If a face is detected, it will be indicated by a white border.
- 5 Press the shutter button halfway to focus.
 - When the camera focuses on the face in the white border, the border will turn green.
 - If the camera is able to detect the subject's eyes, it will display a green frame over the selected eye. (pupil detection AF)
- 6 Press the shutter button the rest of the way down to shoot.



Cautions

- Face priority applies only to the first shot in each sequence taken during sequential shooting.
- Depending on the subject and the art filter setting, the camera may not be able to correctly detect the face.
- When set to \square (Digital ESP metering)), metering is performed with priority given to faces.
- When using a Four Thirds system lens, even if a face is detected, if it is outside the AF area, the face priority AF will not operate.

Notes

- Face priority is also available in [MF]. Faces detected by the camera are indicated by white frames.

Zoom frame AF/zoom AF

You can zoom in on a portion of the frame when adjusting focus. Choosing a high zoom ratio allows you to use autofocus to focus on a smaller area than is normally covered by the AF target. You can also position the focus target more precisely.

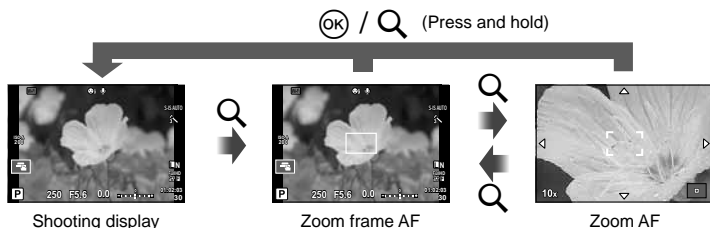

- 1 Assign [Q] to one of the buttons in advance using [Button Function] (P. 99).
 - Q can also be set as a multi-function button.
- 2 Press the Q button to display the zoom frame.
 - If the camera was focused using autofocus just before the button was pressed, the zoom frame will be displayed at the current focus position.
 - Use Δ ∇ \langle \rangle to position the zoom frame.
 - Press the INFO button and use Δ ∇ to choose the zoom ratio.

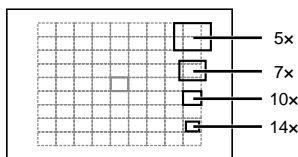

Comparison of AF and zoom frames

- 3 Press the Q button again to zoom in on the zoom frame.
 - Use Δ ∇ \langle \rangle to position the zoom frame.
 - Rotate the dial to choose the zoom ratio.
- 4 Press the shutter button halfway to initiate autofocus.
 - The camera will focus using the subject in the frame at the center of the screen. To change the focus position, move it by touching the screen.

Notes

- You can also display and move the zoom frame using touch screen operations.







Cautions

- Zoom is visible only in the monitor and has no effect on the resulting photographs.
- When you are using a Four Thirds system lens, the AF will not operate with during zoom display.

Sequential shooting/using the self timer

Keep the shutter button pressed all the way down to take a series of photos. Alternatively, you can take pictures using the self timer.



- 1 Set the lever to position 1 and press the HDR button to display the selection items.
- 2 Turn the rear dial and select an item.

 Single-frame shooting	Shoots 1 frame at a time when the shutter button is pressed (normal shooting mode).
 Sequential H	Photographs are taken at about 10 frames per second (fps) while the shutter button is pressed all the way down. Focus, exposure, and white balance are fixed at the values for the first shot in each series ([S-AF], [MF]).
 Sequential L	Photographs are taken at about 6.5 frames per second (fps) while the shutter button is pressed all the way down. Focus and exposure are fixed according to the options selected for [AF Mode] (P. 73) and [AEL/AFL] (P. 98).
 Self-timer 12 SEC	Press the shutter button halfway to focus, the rest of the way down to start the timer. First, the self-timer lamp lights up for approximately 10 seconds, then it blinks for approximately 2 seconds and the picture is taken.
 Self-timer 2 SEC	Press the shutter button halfway to focus, the rest of the way down to start the timer. The self-timer lamp blinks for approximately 2 seconds, and then the picture is taken.
 Self-timer Custom	Set the number of frames to be shot. Select  , press the INFO button, and rotate the dial.

Notes

- To cancel the activated self-timer, press the HDR button.
- In [S-AF] and [MF] focus modes, focus and exposure will be fixed at the values for the first frame in each sequence.

Cautions

- When you are using , no confirmation image is displayed during shooting. The image is displayed again after shooting ends. When you are using , the image shot immediately before is displayed.
- The speed of sequential shooting varies depending on the lens you are using and the focus of the zoom lens.
- During sequential shooting, if the battery check blinks due to low battery, the camera stops shooting and starts saving the pictures you have taken on the card. The camera may not save all of the pictures depending on how much battery power remains.
- Fix the camera securely on a tripod for self-timer shooting.
- If you stand in front of the camera to press the shutter button halfway when using the self-timer, the photograph may be out of focus.

Adjusting color (white balance)

White balance (WB) ensures that white objects in images recorded by the camera appear white. [AUTO] is suitable in most circumstances, but other values can be selected according to the light source when [AUTO] fails to produce the desired results or you wish to introduce a deliberate color cast into your images.

- 1 Set the lever to position 2, and turn the rear dial to select items.

Lever

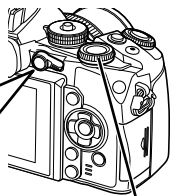
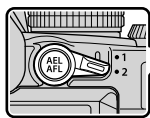











Rear dial



WB mode		Color temperature	Light conditions
Auto white balance	AUTO	—	Used for most light conditions (when there is a white portion framed on the monitor). Use this mode for general use.
Preset white balance		5300K	For shooting outdoors on a clear day, or to capture the reds in a sunset or the colors in a fireworks display
		7500K	For shooting outdoors in the shadows on a clear day
		6000K	For shooting outdoors on a cloudy day
		3000K	For shooting under a tungsten light
		4000K	For subjects lit by fluorescent lights
		—	For underwater photography
		5500K	For flash shooting
One-touch white balance (P. 57)		Color temperature set by one-touch WB.	Choose when a white or gray subject can be used to measure white balance and the subject is under mixed lighting or lit by an unknown type of flash or other light source.
Custom white balance	CWB	2000K – 14000K	After pressing the INFO button, use $\triangleleft \triangleright$ buttons to select a color temperature and then press .

One-touch white balance

Measure white balance by framing a piece of paper or other white object under the lighting that will be used in the final photograph. This is useful when shooting a subject under natural light, as well as under various light sources with different color temperatures.

- 1 Prepare a neutral-colored paper, such as white or gray.
 - Frame the object so that it fills the display and no shadows fall it.
- 2 Shoot while pressing the  (one-touch white balance) button.
 - You can also shoot after selecting , , , or  from the white balance options screen and then pressing INFO.
- 3 Select from , , , or  and register.
 - If it is already selected in the white balance menu, select [Yes] and press the  button.
 - The new value is saved as a preset white balance option.
 - The new value is stored until one-touch white balance is measured again. Turning the power off does not erase the data.



Tips

- If the subject is too bright or too dark or visibly tinted, the message [WB NG Retry] will be displayed and no value will be recorded. Correct the problem and repeat the process from Step 1.

ISO sensitivity

Increasing ISO sensitivity increases noise (graininess) but allows photographs to be taken when lighting is poor. The setting recommended in most situations is [AUTO], which starts at ISO 200 — a value that balances noise and dynamic range — and then adjusts ISO sensitivity according to shooting conditions.

- 1 Set the lever to position 2, and turn the front dial to select items.

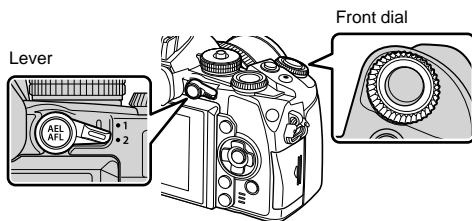

AUTO	The sensitivity is set automatically according to the shooting conditions.
LOW, 200–25600	Sensitivity is set to the selected value.

Controlling color (Color Creator)

You can adjust the color of the subject while looking through the viewfinder. Select this function with the multi-function button to use it.

Set the multi-function button to  (Color Creator) in advance (P. 23).

- 1 While looking through the viewfinder, press the Fn2 button.
 - An options screen will be displayed in the viewfinder.

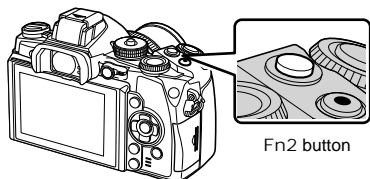

- 2 Set hue using the front dial and saturation using the rear dial.
 - The settings are stored under picture mode.

Cautions

- The white balance is fixed to AUTO.
- When the image quality mode is set to [RAW], the image is recorded in RAW+JPEG.

HDR photography

The camera shoots several images and automatically combines them into an HDR image. You can also shoot several images and perform HDR imaging on a computer (HDR bracketing photography).

- 1 Set the lever to position 1 and press the  HDR button to display the selection items.

- A menu will be displayed on the screen.

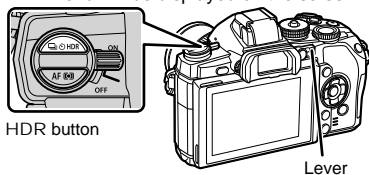

When shooting using live view

- 2 Turn the front dial to select a setting.

HDR1	Four shots are taken, each with a different exposure, and the shots are combined into one HDR image inside the camera. HDR2 provides a more impressive image than HDR1. ISO sensitivity is fixed to 200. Also, the slowest available shutter speed is 1 second and the longest available exposure is 4 seconds.
HDR2	
3F 2.0EV	HDR bracketing is performed. Select the number of images and the exposure difference. HDR imaging processing is not performed.
5F 2.0EV	
7F 2.0EV	
3F 3.0EV	
5F 3.0EV	

- 3 Shoot.

- When you press the shutter button, the camera automatically shoots the set number of images.
- While shooting, a simply composed image will be displayed on the monitor or in the viewfinder.

⚠ Cautions

- In the case of HDR1 and HDR2, exposure compensation is not available.
- If you shoot with a slower shutter speed, there may be more noticeable noise.
- Attach the camera to a tripod or other stabilizing item and then shoot.
- The image displayed on the monitor or in the viewfinder while shooting will differ from the HDR-processed image.
- In the case of HDR1 and HDR2, the HDR-processed image will be saved as a JPEG file. When the image quality mode is set to [RAW], the image is recorded in RAW+JPEG. The only image recorded in RAW is the image with suitable exposure.
- If set to HDR1/HDR2, the picture mode is fixed to [Natural] and the color setting is fixed to [sRGB]. [Full-time AF] does not operate.
- Flash photography, bracketing, multiple exposure and time lapse shooting cannot be used at the same time as HDR photography.

Information display during playback

Playback image information

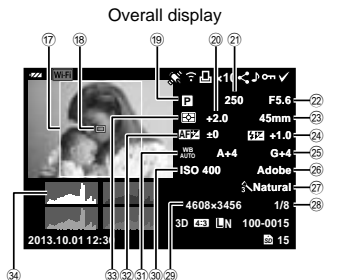
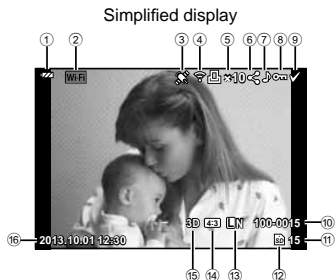

- ① Battery check.....P. 16
- ② Wi-Fi connection.....P. 27, 119
- ③ Including GPS information.....P. 121
- ④ Eye-Fi upload complete.....P. 98
- ⑤ Print reservation
Number of prints.....P. 112
- ⑥ Share order.....P. 62
- ⑦ Sound record.....P. 64
- ⑧ Protect.....P. 64
- ⑨ Image selected.....P. 33
- ⑩ File number.....P. 96
- ⑪ Frame number
- ⑫ Storage device.....P. 123
- ⑬ Record mode.....P. 70
- ⑭ Aspect ratio.....P. 69
- ⑮ 3D image.....P. 45
- ⑯ Date and time.....P. 17
- ⑰ Aspect border.....P. 69

- ⑱ AF target.....P. 52
- ⑲ Shooting mode.....P. 18, 38–46
- ⑳ Exposure compensation.....P. 49
- ㉑ Shutter speed.....P. 38–41
- ㉒ Aperture value.....P. 38–41
- ㉓ Focal length.....P. 128
- ㉔ Flash intensity control.....P. 71
- ㉕ White balance compensation
- ㉖ Color space.....P. 95
- ㉗ Picture mode.....P. 68
- ㉘ Compression rate.....P. 70
- ㉙ Pixel count.....P. 70
- ㉚ ISO sensitivity.....P. 57
- ㉛ White balance.....P. 56
- ㉜ AF Focus adjustments.....P. 107
- ㉝ Metering mode.....P. 72
- ㉞ Histogram.....P. 37

Switching the information display

You can switch the information displayed in the monitor during playback using the INFO button.

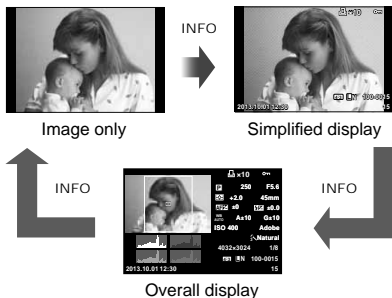

Changing the playback information display method

Press the  button to view pictures full frame. Press the shutter button halfway to return to shooting mode.

Index display/calendar display

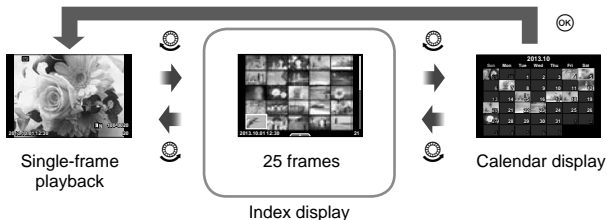

Playback zoom (close-up playback)

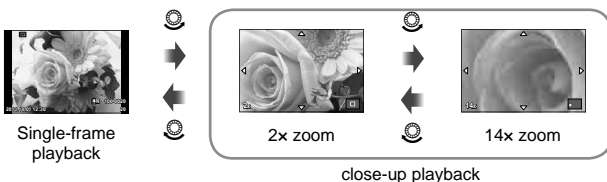





Rear dial (📷)	Zoom in (📷)/Index (📷)
Front dial (📷)	Previous (📷)/Next (📷) Operation also available during close-up playback.
Arrow pad (⬆️ ⬇️ ⬅️)	Single-frame playback: Next (➡️)/previous (⬅️)/playback volume (⬆️ ⬇️) Close-up playback: Scroll image You can display the next frame (➡️) or the previous frame (⬅️) during close-up playback by pressing the INFO button. Index/calendar playback: Highlight image
Fn1	Displays a zoom frame. Use touch operations to set the position of the frame and press Fn1 to zoom in. To cancel, press Fn1.
INFO	View image info
☑️	Select picture (P. 33)
AEL/AFL	Protect picture (P. 32)
🗑️	Delete picture (P. 33)
OK	View menus (in calendar playback, press this button to exit to single-frame playback)

Sharing images over Wi-Fi connection (Share Order)

You can connect the camera to a smartphone over wireless LAN (P. 119). Once the smartphone is connected, you can use it view images stored on the card, and transfer images between the camera and smartphone.

With [Share Order], you can select the images to share in advance.

- 1 On the playback screen, touch the screen.
 - A touch menu will be displayed.
- 2 Select an image using a touch operation or  and then touch  on the touch menu.
 -  is displayed on the images selected for sharing.
 - To cancel the selection, touch  again.
- 3 Touch the screen to exit [Share Order].
 - After an image has been selected for sharing, the selected image will be shared when a Wi-Fi connection is established using [One-Time].

Cautions

- You can set a share order on a maximum around 200 frames.
- Not available for [SD] or [HD] movies.

Manipulating playback images

Press **OK** during playback to display a menu of simple options that can be used in playback mode.



	Still image frame	Movie frame
JPEG Edit, RAW Data Edit P. 85, 86	✓	—
Image Overlay P. 87	✓	—
Movie Play	—	✓
Share Order P. 62	✓	✓ *
(Protect)	✓	✓
(Audio recording)	✓	—
Rotate	✓	—
(Slideshow)	✓	✓
Erase	✓	✓

* Not available for [SD] or [HD] movies.

Performing operations on a movie frame (Movie Play)

OK	Pause or resume playback.	
	• You can perform the following operations while playback is paused.	
	◀▶ or dial	Previous/Next Press and hold ◀▶ to continue the operation.
	▲	Display the first frame.
	▼	Display the last frame.
◀▶	Advance or rewind a movie.	
▲/▼	Adjust volume.	

Cautions

- We recommend using the supplied PC software to play movies on a computer. Before launching the software for the first time, connect the camera to the computer.

Protecting images

Protect images from accidental deletion. Display an image you wish to protect and press **OK** to display the playback menu.

Select [**Protect**] and press **OK**, and then press **Δ** to protect the image. Protected images are shown by a **Protect** icon. Press **▽** to remove protection. Press **OK** to save settings and exit.

You can also protect multiple selected images. **Selecting images**



⚠ Cautions

- Formatting the card erases all images even if they have been protected.

Audio recording

Add an audio recording (up to 30sec. long) to the current photograph.

- 1 Display the image to which you want to add an audio recording and press **OK**.
 - Audio recording is not available with protected images.
 - Audio recording is also available in the playback menu.
- 2 Select [**Audio**] and press **OK**.
 - To exit without adding a recording, select [No].
- 3 Select [**Start**] and press **OK** to begin recording.
 - To stop recording part-way through, press **OK**.
- 4 Press **OK** to end recording.
 - Images with audio recordings are indicated by a **Audio** icon.
 - To delete a recording, select [Erase] in Step 2.

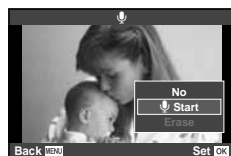

Rotate

Choose whether to rotate photographs.

- 1 Play the photograph back and press **OK**.
- 2 Select [Rotate] and press **OK**.
- 3 Press **Δ** to rotate the image counterclockwise, **▽** to rotate it clockwise; the image rotates each time the button is pressed.
 - Press **OK** to save settings and exit.
 - The rotated image is saved in its current orientation.
 - Movies, 3D photos, and protected images cannot be rotated.

Slideshow

This function displays images stored on the card one after another.

- 1 Press **OK** during playback and select **[Slide]**.



- 2 Adjust settings.

Start	Start the slideshow. Images are displayed in order, starting with the current picture.
BGM	Set BGM or turn BGM [Off].
Slide	Set type of slideshow to execute.
Slide Interval	Choose the length of time each slide is displayed from 2 to 10 seconds.
Movie Interval	Select [Full] to include full-length movie clips in the slideshow, [Short] to include only the opening portion of each clip.

- 3 Select [Start] and press **OK**.
 - The slideshow will start.
 - Press **OK** to stop the slideshow.

Volume

Press **Δ**/**▽** during the slideshow to adjust the overall volume of the camera speaker.

Press **◀**/**▶** to adjust the balance between the background music and the sound recorded with photographs or movies.

Notes

- You can change [Joy] to different BGM. Record the data downloaded from the Olympus website onto the card, select [Joy] from [BGM] in step 2, and press **▷**. Visit the following website for the download.
<http://support.olympus-imaging.com/bgmdownload/>

6 Using shooting options

Reducing camera shake (image stabilizer)

You can reduce the amount of camera shake that can occur when shooting in low light situations or shooting with high magnification. The image stabilizer starts when you press the shutter button halfway.

- 1 Press the **OK** button and select the image stabilizer.



When shooting using the viewfinder



When shooting using live view

- 2 Select an item using the front dial and press the **OK** button.

Still picture	OFF	S-I.S. Off	Image stabilizer is off.
	S-IS1	Auto	Image stabilizer is on.
	S-IS2	Vertical IS	Image stabilization applies only to vertical (Ⓜ) camera shake. Use when panning the camera horizontally.
	S-IS3	Horizontal IS	Image stabilization applies only to horizontal (Ⓜ) camera shake. Use when panning the camera horizontally with the camera held in portrait orientation.
	S-IS AUTO	Landscape Panning I.S.	The camera detects the panning direction and applies the appropriate image stabilization.
Movie	OFF	M-I.S. Off	Image stabilizer is off.
	ON	Movie-I.S.	In addition to Auto image stabilization, camera shake that occurs when shooting while walking is also reduced.

Choosing a focal length (Micro Four Thirds/Four Thirds System lenses excluded)

Use focal length information to reduce camera shake when shooting with lenses that are not Micro Four Thirds or Four Thirds system lenses.

- Select [Image Stabilizer], press the INFO button, use **◀▶** to select a focal length, and press **OK**.
- Choose a focal length between 8 mm and 1000 mm.
- Choose the value that most closely matches to the one that is printed on the lens.

Cautions

- The image stabilizer cannot correct excessive camera shake or camera shake that occurs when the shutter speed is set to the slowest speed. In these cases, it is recommended that you use a tripod.
- When using a tripod, set [Image Stabilizer] to [OFF].
- When using a lens with an image stabilization function switch, priority is given to the lens side setting.
- When priority is being given to the lens side image stabilization and the camera side is set to [S-IS-AUTO], [S-IS1] is used instead of [S-IS-AUTO].
- You may notice an operating sound or vibration when the image stabilizer is activated.

Processing options (picture mode)

Select a picture mode and make individual adjustments to contrast, sharpness, and other parameters (P. 78). Changes to each picture mode are stored separately.

- 1 Press the **OK** button and select [Picture Mode].

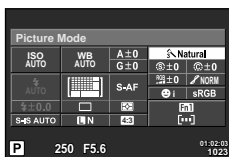

When shooting using the viewfinder





When shooting using live view

- 2 Select an item using the front dial and press the **OK** button.

	i-Enhance	Produces more impressive-looking results suited to the scene.
	Vivid	Produces vivid colors.
	Natural	Produces natural colors.
	Muted	Produces flat tones.
	Portrait	Produces beautiful skin tones.
	Monotone	Produces black and white tone.
	Custom	Select one picture mode, set the parameters, and register the setting.
	e-Portrait	Produces smooth skin textures. Cannot be used with bracket photography or when shooting movies.
	Color Creator	Produces colors set using color creator (P. 58).
	Pop Art	Choose an art filter and select the desired effect.
	Soft Focus	
	Pale&Light Color	
	Light Tone	
	Grainy Film	
	Pin Hole	
	Diorama	
	Cross Process	
	Gentle Sepia	
	Dramatic Tone	
	Key Line	
	Watercolor	

Adding effects to a movie

You can create movies that take advantage of the effects available in still photography mode. Set the dial to  to enable the settings.

- 1 Set the shooting mode to , press the  button, and use the rear dial to select a shooting mode item.



- 2 Switch the shooting mode using the front dial and press the  button.



P	Optimal aperture is set automatically according to the brightness of the subject.
A	Depiction of background is changed by setting the aperture. Use the rear dial to adjust the aperture.
S	Shutter speed affects how the subject appears. Use the rear dial to adjust the shutter speed. Shutter speed can be set to values between 1/30 s and 1/4000 s.
M	You control both aperture and shutter speed. Use the front dial to choose the aperture, the rear dial to select the shutter speed from values between 1/30 s and 1/4000 s. Sensitivity can be set manually to values between ISO 200 and 3200; auto ISO sensitivity control is not available.

Cautions

- When recording a movie, you cannot change the settings for exposure compensation, aperture value, and shutter speed.
- If [Image Stabilizer] is activated while recording a movie, the recorded image is enlarged slightly.
- Stabilization is not possible when the camera shake is excessive.
- When the inside of the camera becomes hot, shooting is automatically stopped to protect the camera.
- With some art filters, [C-AF] operation is limited.
- Cards with an SD speed class of 6 or above are recommended for movie recording.

Setting the image aspect

You can change the aspect ratio (horizontal-to-vertical ratio) when taking pictures. Depending on your preference, you can set the aspect ratio to [4:3] (standard), [16:9], [3:2], [1:1], or [3:4].

- 1 Press the  button and select an aspect ratio.
- 2 Select a setting using the front dial and press the  button.

Cautions

- JPEG images are cropped to the selected aspect ratio; RAW images, however, are not cropped but are instead saved with information on the selected aspect ratio.
- When RAW images are played back, the selected aspect ratio is shown by a frame.

Image quality (record mode)

Select an image quality for photographs and movies according to their intended use, for example retouching on a computer or display on the web.

- 1 Press the **OK** button and select an image quality for photographs or movies.



When shooting using the viewfinder



Record mode

When shooting using live view

- 2 Select an item using the front dial and press the **OK** button.

Record modes (still images)

Choose from RAW and JPEG (**L**F, **L**N, **M**N, and **S**N) modes. Choose a RAW+JPEG option to record both a RAW and a JPEG image with each shot. JPEG modes combine image size (**L**, **M**, and **S**) and compression ratio (SF, F, N, and B).

Image size		Compression rate				Application
Name	Pixel count	SF (Super Fine)	F (Fine)	N (Normal)	B (Basic)	
L (Large)	4608x3456*	L SF	L F*	L N*	L B	Select for the print size
M (Middle)	3200x2400	M SF	M F	M N*	M B	
	2560x1920*					
	1920x1440					
S (Small)	1600x1200	S SF	S F	S N*	S B	For small prints and use on a website
	1280x960*					
	1024x768					
	640x480					

* Default

RAW image data

This format (extension “.ORF”) stores unprocessed image data for later processing. RAW image data cannot be viewed using other cameras or software, and RAW images cannot be selected for printing. JPEG copies of RAW images can be created using this camera.

“Editing still images” (P. 85)

■ Record modes (movies)

Record mode	Pixel count	File format	Application
Full HD Fine	1920×1080	MPEG-4 AVC/ H.264*1	Display on TVs and other devices
Full HD Normal	1920×1080		
HD Fine	1280×720		
HD Normal	1280×720		
HD	1280×720	Motion JPEG*2	For computer playback or editing
SD	640×480		

- Depending on the type of card used, recording may end before the maximum length is reached.

*1 Individual movies can be up to 29 minutes long.

*2 Files may be up to 2GB in size.

Adjusting flash output (flash intensity control)

Flash output can be adjusted if you find that your subject appears overexposed, or is underexposed even though the exposure in the rest of the frame is just right.

- 1 Set the lever to position 2 and press the AF  button.

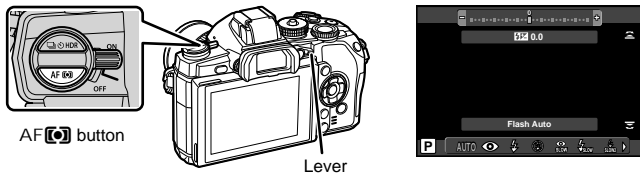

- 2 Select an item using the front dial and press the  button.

Cautions

- This setting has no effect when the flash control mode for the external flash unit is set to MANUAL.
- Changes to flash intensity made with the external flash unit are added to those made with the camera.

Choosing how the camera measures brightness (metering)





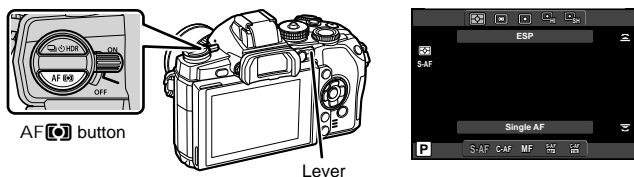

Choose how the camera meters subject brightness.

1 Set the lever to position 1 and press the AF button.

- You can also press the **OK** button to select metering.

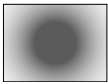

2 Turn the front dial to select an item.

	Digital ESP metering	The camera meters exposure in 324 areas of the frame and optimizes exposure for the current scene or (if an option other than [OFF] is selected for [Face Priority]) portrait subject. This mode is recommended for general use.
	Center weighted averaging metering	This metering mode provides the average metering between the subject and the background lighting, placing more weight on the subject at the center. 
	Spot metering	Choose this option to meter a small area (about 2% of the frame) with the camera pointed at the object you wish to meter. Exposure will be adjusted according to the brightness at the metered point. 
	Spot metering - highlight	Increases spot metering exposure. Ensures bright subjects appear bright.
	Spot metering - shadow	Lowers spot metering exposure. Ensures dark subjects appear dark.

3 Press the shutter button halfway.

- Normally, the camera will start metering when the shutter button is pressed halfway and lock exposure while the shutter button is held in this position.

Choosing a focus mode (AF mode)

Select a focusing method (focus mode).

You can choose separate focusing methods for still photography mode and  mode.

1 Set the lever to position 1 and press the AF  button.

- You can also press the  button to select AF mode.

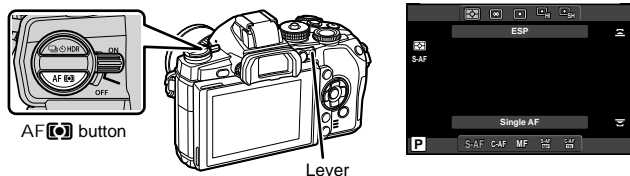

2 Turn the rear dial to select an item.

- The selected AF mode is displayed on the monitor.

S-AF (single AF)	The camera focuses once when the shutter button is pressed halfway. When the focus is locked, a beep sounds, and the AF confirmation mark and the AF target mark light up. This mode is suitable for taking pictures of still subjects or subjects with limited movement.
C-AF (continuous AF)	The camera repeats focusing while the shutter button remains pressed halfway. When the subject is in focus, the AF confirmation mark lights up on the monitor and the beep sounds when the focus is locked at the first and second time. Even if the subject moves or you change the composition of the picture, the camera continues trying to focus.
MF (manual focus)	This function allows you to manually focus on any subject.  Focus ring
S-AF+MF (simultaneous use of S-AF mode and MF mode)	After pressing the shutter button halfway to focus in [S-AF] mode, you can turn the focus ring to fine-adjust focus manually.
C-AF+TR (AF tracking)	Press the shutter button halfway to focus; the camera then tracks and maintains focus on the current subject while the shutter button is held in this position. <ul style="list-style-type: none"> The AF target is displayed in red if the camera can no longer track the subject. Release the shutter button and then frame the subject again and press the shutter button halfway. With a Four Thirds system lens, the tracking range narrows. If the AF target is displayed in red, AF does not operate even if the subject is tracked.

Cautions

- The camera may be unable to focus if the subject is poorly lit, obscured by mist or smoke, or lacks contrast.
- When using a Four Thirds system lens, the AF will not operate while recording movies.

Movie sound options (recording sound with movies)

- 1 Press the **OK** button when shooting with live view and select a movie sound.

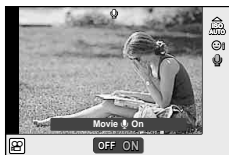

When shooting using live view

- 2 Switch ON/OFF using the front dial and press the **OK** button.

! Cautions

- When recording sound in a movie, the sound made by the lens and camera operating may be recorded. If desired, you can reduce these sounds by shooting with [AF Mode] set to [S-AF], or by limiting the amount of times you press the buttons. You can use an external microphone.
- No sound is recorded in **ARV** (Diorama) mode.

7 Menu functions

Basic menu operations

The menus contain shooting and playback options that are not displayed by the live control, and let you customize the camera settings for easier use.

	Preliminary and basic shooting options
	Advanced shooting options
	Playback and retouch options
	Customizing camera settings (P. 90)
	Accessory port menu options for accessory port devices such as EVF and OLYMPUS PENPAL (P. 108)*
	Camera setup (e.g., date and language)

* Not displayed at default settings.

1 Press the MENU button to display the menus.



2 Use Δ / ∇ to select a tab and press OK .

3 Select an item using Δ / ∇ and press OK to display options for the selected item.

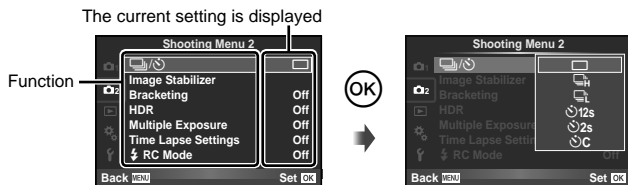

4 Use Δ / ∇ to highlight an option and press OK to select.

- Press the MENU button repeatedly to exit the menu.

Notes

- For the default settings of each option, refer to "Menu directory" (P. 142).
- A guide is displayed for about 2 seconds after you select an option. Press the INFO button to view or hide guides.

Using Shooting Menu 1/Shooting Menu 2

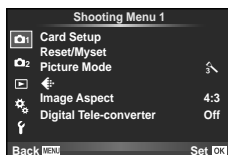

- ❏ Card Setup (P. 76)
- ❏ Reset/Myset (P. 77)
- ❏ Picture Mode (P. 78)
- ❏ Image Aspect (P. 69)
- ❏ Digital Tele-converter (P. 84)
- ❏ (Sequential shooting/Self-timer) (P. 55, 79)
- ❏ Image Stabilizer (P. 66)
- ❏ Bracketing (P. 80)
- ❏ HDR (P. 84)
- ❏ Multiple Exposure (P. 82)
- ❏ Time Lapse Settings (P. 83)
- ❏ RC Mode (P. 84)

7

Formatting the card (Card Setup)

Cards must be formatted with this camera before first use or after being used with other cameras or computers.

All data stored on the card, including protected images, is erased when the card is formatted.

When formatting a used card, confirm there are no images that you still want to keep on the card. "Usable cards" (P. 123)

1 Select [Card Setup] in Shooting Menu 1.

2 Select [Format].

3 Select [Yes] and press .

- Formatting is performed.

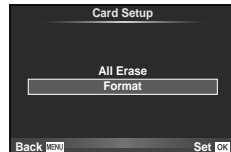

Restoring default settings (Reset/Myset)

Camera settings can be easily restored to registered settings.

Using reset settings

Restore default settings.

- 1 Select [Reset/Myset] in Shooting Menu 1.
- 2 Select [Reset] and press .
 - Highlight [Reset] and press to choose the reset type. To reset all settings except the time, date, and a few others, highlight [Full] and press .
 "Menu directory" (P. 142)



- 3 Select [Yes] and press .

Saving Myset

You can save the current camera settings for modes other than shooting mode. Saved settings can be called up in **P**, **A**, **S**, and **M** modes.

- 1 Adjust settings in order to save.
- 2 Select [Reset/Myset] in Shooting Menu 1.
- 3 Select the desired destination ([Myset1]–[Myset4]) and press .
 - [Set] appears next to destinations ([Myset1]–[Myset4]) to which settings have already been saved. Selecting [Set] again overwrites the registered setting.
 - To cancel the registration, select [Reset].
- 4 Select [Set] and press .
 - Settings that can be saved to Myset "Menu directory" (P. 142)

Using Myset

Sets the camera to the settings selected for Myset.

- 1 Select [Reset/Myset] in Shooting Menu 1.
- 2 Select the desired settings ([Myset1]–[Myset4]) and press .
- 3 Select [Set] and press .







Processing options (Picture Mode)

You can make individual adjustments to contrast, sharpness and other parameters in [Picture Mode] (P. 68) settings. Changes to each picture mode are stored separately.

- 1 Select [Picture Mode] in  Shooting Menu 1.



- 2 Select an option with Δ ∇ and press \odot .
- 3 Press \triangleright to display settings for the selected option.

					
Contrast	Distinction between light and dark	✓	✓	✓	✓
Sharpness	Sharpness of the image	✓	✓	✓	✓
Saturation	Vividness of the color	✓	✓	—	✓
Gradation	Adjust tone (gradation).				
Auto	Divides the image into detailed regions and adjusts the brightness separately for each region. This is effective for images with areas of large contrast in which the whites appear too bright or the blacks appear too dark.	✓	✓	✓	✓
Normal	Use [Normal] mode for general uses.				
High Key	Gradation for a bright subject.				
Low Key	Gradation for a dark subject.				
Effect (i-Enhance)	Sets the extent that the effect will be applied.	✓	—	—	✓
B&W Filter (Monotone)	Creates a black and white image. The filter color is brightened and the complementary color is darkened.				
N:Neutral	Creates a normal black and white image.				
Ye:Yellow	Reproduces clearly defined white cloud with natural blue sky.				
Or:Orange	Slightly emphasizes colors in blue skies and sunsets.	—	—	✓	✓
R:Red	Strongly emphasizes colors in blue skies and brightness of crimson foliage.				
G:Green	Strongly emphasizes colors in red lips and green leaves.				

Pict. Tone (Monotone)	Colors the black and white image.				
N:Neutral	Creates a normal black and white image.				
S:Sepia	Sepia	—	—	✓	✓
B:Blue	Bluish				
P:Purple	Purplish				
G:Green	Greenish				

Cautions

- Changes to contrast have no effect at settings other than [Normal].

Image quality ()

Select an image quality. You can select a separate image quality for photographs and movies. This is the same as the [] item in [Live Control].

- You can change the JPEG image size and compression ratio combination, and [] and [] pixel counts. [Set], [Pixel Count] "Using the custom menus" (P. 90)

Setting the self timer ()

You can customize the self timer operation.

- 1 Select [] in Shooting Menu 2.





- 2 Select [] (custom) and press .
- 3 Use to select the item and press .
 - Use to select the setting and press .



Frame	Sets the number of frames to be shot.
Timer	Sets the time after the shutter button is pressed until the picture is taken.
Interval Time	Sets the shooting interval for the second and subsequent frames.

Varying settings over a series of photographs (bracketing)



"Bracketing" refers to the act of varying settings automatically over a series of shots or a series of images to "bracket" the current value. You can store bracket shooting settings and turn bracket shooting off.

- 1 Select [Bracketing] in  Shooting Menu 2 and press .



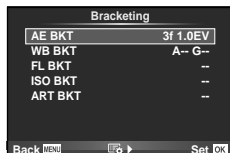

- 2 After selecting [On], press  and select a bracket shooting type.
 - When you select bracket shooting,  appears on the screen.



- 3 Press , select settings for parameters such as the number of shots, and then press the  button.
 - Continue to press the  button until you return to the screen in step 1.
 - If you select [Off] in step 2, bracket shooting settings will be saved and you can shoot normally.

Tips



- You can also use button operations for bracket settings. Set the lever to position 2 and turn the dial while pressing the  button. Select the bracket shooting type using the front dial and the number of shots and other parameters using the rear dial. After performing the settings, you can switch between bracket photography and normal photography each time you press the  button.

Cautions

- Cannot be used during HDR photography.
- Cannot be used at the same time as multiple exposure and time lapse shooting.

AE BKT (AE bracketing)

The camera varies the exposure of each shot. The modification amount can be selected from 0.3 EV, 0.7 EV, or 1.0 EV. In single-frame shooting mode, one photograph is taken each time the shutter button is pressed all the way down, while in sequential shooting mode the camera continues to take shots in the following order while the shutter button is pressed all the way down: no modification, negative, positive. Number of shots: 2, 3, 5, or 7

- The  indicator turns green during bracketing.
- The camera modifies exposure by varying aperture and shutter speed (mode **P**), shutter speed (modes **A** and **M**), or aperture (mode **S**).
- The camera brackets the value currently selected for exposure compensation.
- The size of the bracketing increment changes with the value selected for [EV Step].  "Using the custom menus" (P. 90)

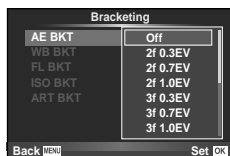

WB BKT (WB bracketing)

Three images with different white balances (adjusted in specified color directions) are automatically created from one shot, starting with the value currently selected for white balance. WB bracketing is available in **P**, **A**, **S** and **M** modes.

- White balance can be varied by 2, 4, or 6 steps on each of the A–B (Amber–Blue) and G–M (Green–Magenta) axes.
- The camera brackets the value currently selected for white balance compensation.
- No pictures will be taken during WB bracketing if there is not enough memory on the card for the selected number of frames.



FL BKT (FL bracketing)

The camera varies flash level over three shots (no modification on the first shot, negative on the second, and positive on the third). In single-frame shooting, one shot is taken each time the shutter button is pressed; in sequential shooting, all shots are taken while the shutter button is pressed.

- The **[BKT]** indicator turns green during bracketing.
- The size of the bracketing increment changes with the value selected for [EV Step]. "Using the custom menus" (P. 90)

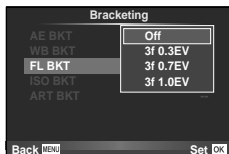

ISO BKT (ISO bracketing)

The camera varies the sensitivity over three shots while keeping the shutter speed and aperture fixed. The modification amount can be selected from 0.3 EV, 0.7 EV, or 1.0 EV. Each time the shutter button is pressed, the camera shoots three frames with the set sensitivity (or if auto sensitivity is selected, the optimal sensitivity setting) on the first shot, negative modification on the second shot, and positive modification on the third shot.

- The size of the bracketing increment does not change with the value selected for [ISO Step]. "Using the custom menus" (P. 90)
- Bracketing is performed regardless of the upper limit set with [ISO-Auto Set]. "Using the custom menus" (P. 90)

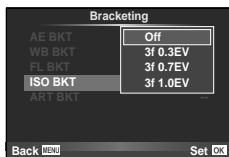

ART BKT (ART bracketing)

Each time the shutter is released, the camera records multiple images, each with a different art filter setting. You can turn art filter bracketing on or off separately for each picture mode.

- Recording may take some time.
- ART BKT cannot be combined with WB BKT or ISO BKT.

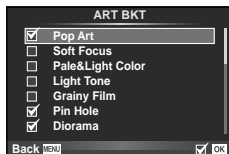

Recording multiple exposures in a single image (multiple exposure)

Record multiple exposures in a single image, using the option currently selected for image quality.

1 Select [Multiple Exposure] in  Shooting Menu 2.



2 Adjust settings.

Frame	Select [2f].
Auto Gain	When set to [On], the brightness of each frame is set to 1/2 and the images are overlaid. When set to [Off], the images are overlaid with the original brightness of each frame.
Overlay	When set to [On], a RAW image recorded on a card can be overlaid with multiple exposures and stored as a separate image. The number of pictures taken is one.

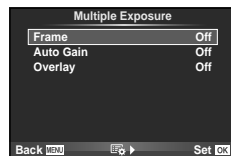

-  is displayed in the monitor while multiple exposure is in effect.



3 Shoot.

-  is displayed in green when shooting starts.
- Press  to delete the last shot.
- The previous shot is superimposed on the view through the lens as a guide to framing the next shot.

Tips

- To overlay 3 or more frames: Select RAW for [] and use the [Overlay] option to make repeated multiple exposures.
- For more information on overlaying RAW images:  [Edit] (P. 85)

Cautions

- The camera will not go to sleep while multiple exposure is in effect.
- Photographs taken with other cameras cannot be included in a multiple exposure.
- When [Overlay] is set to [On], the images displayed when a RAW image is selected are developed with the settings at the time of shooting.
- To set the shooting functions, cancel multiple exposure shooting first. Some functions cannot be set.
- Multiple exposure is cancelled automatically from the first picture in the following situations.
 - The camera is turned off/The  button is pressed/The MENU button is pressed/The shooting mode is set to a mode other than **P**, **A**, **S**, **M**/The battery power runs out/Any cable is connected to the camera
- When a RAW image is selected using [Overlay], the JPEG image for the image recorded in RAW+JPEG is displayed.
- When shooting multiple exposures using bracketing, priority is given to multiple exposure shooting. While the overlay image is being saved, bracketing is reset to the factory default setting.

Shooting automatically with a fixed interval (time lapse shooting)

You can set the camera to shoot automatically with a set time lapse. The shot frames can also be recorded as into a single movie. This setting is only available in **P/A/S/M** modes.

- 1 Perform the following settings under [Time Lapse Settings] in Shooting Menu 2.

Frame	Sets the number of frames to be shot.
Start Waiting Time	Sets waiting time before starting to shot.
Interval Time	Sets interval between shots after shooting starts.
Time Lapse Movie	Sets recording format of frame sequence. [Off]: Records each frame as a still picture. [On]: Records each frame as a still picture and generates and records a single movie from the frame sequence.

- The image quality of the movie is [M-JPEG HD] and the frame rate 10fps.

2 Shoot.

- Frames are shot even if the image is not in focus after AF. If you wish to fix the focus position, shoot in MF.
- [Rec View] operates for 0.5 seconds.
- If either of the time before shooting, or shooting interval is set to 1 minute 30 seconds or longer, the monitor and camera power will turn off after 1 minute. 10 seconds before shooting, the power will automatically turn on again. When the monitor is off, press the shutter button to turn it on again.

Tips

- Longer shooting times are possible using a power battery holder (sold separately) (P. 129) and an AC adaptor. A maximum of 999 shots are possible.

Cautions

- If the AF mode is set to [C-AF] or [C-AF+TR], it is automatically changed to [S-AF].
- Touch operations are disabled during time lapse shooting.
- Cannot be used with HDR photography.
- Bracketing and multiple exposure cannot be used together.
- The flash will not work if the flash charging time is longer than the interval between shots.
- For [BULB] and [TIME] shooting, the shutter speed is fixed to 60 seconds.
- If the camera automatically turns off in interval between shots, it will turn on in time for the next shot.
- If the any of the still pictures are not recorded correctly, the time lapse movie will not be generated.
- If there is insufficient space on the card, the time lapse movie will not be recorded.
- Time lapse shooting will cancelled if any of the following is operated: Mode dial, MENU button, button, lens release button, or connecting the USB cable.
- If you turn off the camera, time lapse shooting will be cancelled.
- If there is not enough charge left on the battery, the shooting may end partway through. Make sure the battery is suitably charged before starting.

Wireless remote control flash photography

You can use the supplied flash and a flash equipped with the RC mode function to perform wireless flash photography.  "Wireless remote control flash photography" (P. 131)

Digital Zoom (Digital Tele-converter)







Digital Tele-converter is used to zoom in beyond the current zoom ratio. The camera saves the center crop. Zoom is increased by about 2x.

1 Select [On] for [Digital Tele-converter] in  Shooting Menu 1.

2 The view in the monitor will be enlarged by a factor of two.

- The subject will be recorded as it appears in the monitor.

Cautions

- Digital zoom is not available with multiple exposures, in  mode, or when , , , , or  is selected in SCN mode.
- This function is not available when [Movie Effect] is [On] in  mode.
- When a RAW image is displayed, the area visible in the monitor is indicated by a frame.
- AF target drops.

HDR photography

Automatically shoot an HDR combination image, or shoot bracketing images to be used for HDR combining. This is the same as pressing the HDR button to perform settings (P. 59).

Using the playback menu

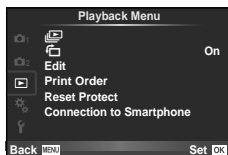

 (P. 65)
 (P. 85)
Edit (P. 85)









Print Order (P. 112)
Reset Protect (P. 87)
Connection to Smartphone (P. 87)

Displaying images rotated ()



When set to [On], photographs taken with the camera rotated in portrait orientation are automatically rotated and displayed in portrait orientation.

Editing still images

Recorded images can be edited and saved as new images.

- 1 Select [Edit] in the  Playback Menu and press .
- 2 Use   to select [Sel. Image] and press .
- 3 Use   to select the image to be edited and press .
 - [RAW Data Edit] is displayed if the picture is a RAW image, [JPEG Edit] if it is a JPEG image. If the image was recorded in RAW+JPEG format, both [RAW Data Edit] and [JPEG Edit] will be displayed. Select the menu for the image to be edited.
- 4 Select [RAW Data Edit] or [JPEG Edit] and press .

RAW Data Edit	Create a JPEG copy of a RAW image edited according to the settings.	
	[Current]	The JPEG copy is processed using the current camera settings. Adjust the camera settings before choosing this option.
	[Custom1]	Editing can be performed while changing the settings on the monitor. You can save the settings used.
	[Custom2]	
	ART BKT	The image is edited using settings for the selected art filter.

JPEG Edit	<p>Choose from the following options:</p> <p>[Shadow Adj]: Brightens a dark backlit subject.</p> <p>[Redeye Fix]: Reduces the red-eye phenomenon during flash shooting.</p> <p>[]: Use the dial to choose the size of the crop and $\Delta \nabla \triangleleft \triangleright$ to position the crop.</p>  <p>[Aspect]: Changes the aspect ratio of images from 4:3 (standard) to [3:2], [16:9], [1:1], or [3:4]. After changing the aspect ratio, use $\Delta \nabla \triangleleft \triangleright$ to specify the trimming position.</p> <p>[Black & White]: Creates black and white images.</p> <p>[Sepia]: Creates sepia-toned images.</p> <p>[Saturation]: Sets the color depth. Adjust the color saturation checking the picture on the screen.</p> <p>[]: Converts the image file size to 1280 x 960, 640 x 480, or 320 x 240. Images with an aspect ratio other than 4:3 (standard) are converted to the closest image file size.</p> <p>[e-Portrait]: Makes skin look smooth and translucent. You may not be able to compensate depending on the image if face detection fails.</p>
------------------	--

5 When the settings are complete, press \odot .

- The settings will be applied to the image.

6 Select [Yes] and press \odot .

- The edited image is stored in the card.

! Cautions







- Movies and 3D photos cannot be edited.
- Red-eye correction may not work depending on the image.
- Editing of a JPEG image is not possible in the following cases:
 - When an image is processed on a PC, when there is not enough space in the card memory, when an image is recorded on another camera
- When resizing () an image, you cannot select a larger number of pixels than was originally recorded.
- [] and [Aspect] can only be used to edit images with an aspect ratio of 4:3 (standard).
- When [Picture Mode] is set to [ART], [Color Space] is locked to [sRGB].

Image overlay

Up to 3 frames of RAW images taken with the camera can be overlaid and saved as a separate image.

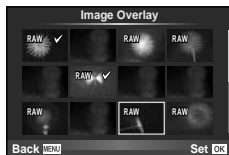

The image is saved with the record mode set at the time the image is saved. (If [RAW] is selected, the copy will be saved in [L+N+RAW] format.)

- 1 Select [Edit] in the  Playback Menu and press .
- 2 Use $\Delta \nabla$ to select [Image Overlay] and press .
- 3 Select the number of images in the overlay and press .
- 4 Use $\Delta \nabla \langle \rangle$ to select the RAW images that will be used in the overlay.
 - When you have selected the number of images specified in Step 3, the overlay will be displayed.



- 5 Adjust gain.
 - Use $\langle \rangle$ to select an image and use $\Delta \nabla$ to adjust gain.
 - Gain can be adjusted in the range 0.1–2.0. Check the results in the monitor.



- 6 Press . A confirmation dialog will be displayed; select [Yes] and press .

Tips

- To overlay 4 or more frames, save the overlay image as a RAW file and use [Image Overlay] repeatedly.



Audio recording

Add an audio recording (up to 30sec. long) to the current photograph.

This is the same function as  during playback. (P. 64)

Canceling all protections

This function lets you cancel the protection of several images at one time.

- 1 Select [Reset Protect] in the  Playback Menu.
- 2 Select [Yes] and press .

Using the Smartphone connection option (Connection to Smartphone)

The camera can connect to a smartphone by using the wireless LAN function. Once connected camera images can be viewed on and transferred to the other device. 
 “Using the camera wireless LAN function” (P. 119)

Using the setup menu

Use the Setup Menu to set the basic camera functions.



Option	Description	
(Date/time setting)	Set the camera clock.	17
(Changing the display language)	You can change the language used for the on-screen display and error messages from English to another language.	—
(Monitor brightness adjustment)	You can adjust the brightness and color temperature of the monitor. Color temperature adjustment will affect only the monitor display during playback. Use to highlight (color temperature) or (brightness) and to adjust the value. Press the INFO button to switch between [Natural] and [Vivid] monitor color display.	—
Rec View	Choose whether pictures are displayed immediately after shooting and for how long. This is useful for making a brief check of the picture you have just taken. Pressing the shutter button halfway while checking the picture lets you resume shooting immediately. [0.3sec]–[20sec]: Selects the number of seconds to display each picture. [Off]: The picture being recorded to the card is not displayed. [Auto▶]: Displays the image being recorded, and then switches to playback mode. This is useful for erasing a picture after checking it.	—
Wi-Fi Settings	Set up the camera to connect to a smartphone with Wi-Fi connectivity using the wireless function on the camera.	89
Menu Display	Choose whether to display the custom or accessory port menu.	108
Firmware	Your product's firmware version will be displayed. When you make inquiries about your camera or accessories or when you want to download software, you will need to state which version of each of the products you are using.	—

Setting up a wireless LAN connection (Wi-Fi Settings)

To use the wireless LAN functions on the camera (P. 119), you need to make setting such as the password to be used when connecting. [Private] and [One-Time] for a one-time connection are available.

Setting password selection method

- 1 Select [Wi-Fi Settings] in the **f** Setup Menu and press **OK**.
- 2 Select [Wi-Fi Connect Settings] and press **▷**.
- 3 Select the wireless LAN connection method and press **OK**.
 - [Private]: Connect using a preset password.
 - [One-Time]: Connect using a different password each time.
 - [Select]: Select which method to use each time.
 - [Off]: The Wi-Fi function is turned off.

Changing private connection password

Change the password used for [Private].

- 1 Select [Wi-Fi Settings] in the **f** Setup Menu and press **OK**.
- 2 Select [Private Password] and press **▷**.
- 3 Follow the operation guide and press the **⊙** button.
 - A new password will be set.

Cancelling image sharing

Deselects images selected for sharing (P. 62) when connected to a wireless LAN network.

- 1 Select [Wi-Fi Settings] in the **f** Setup Menu and press **OK**.
- 2 Select [Reset share Order] and press **▷**.
- 3 Select [Yes] and press **OK**.

Initializing wireless LAN settings

















Initializes content of [Wi-Fi Settings].

- 1 Select [Wi-Fi Settings] in the **f** Setup Menu and press **OK**.
- 2 Select [Reset Wi-Fi Settings] and press **▷**.
- 3 Select [Yes] and press **OK**.

Using the custom menu

Camera settings can be customized using the  Custom Menu.

Custom Menu





-  AF/MF (P. 90)
-  Button/Dial/Lever (P. 91)
-  Release/ (P. 91)
-  Disp//PC (P. 92)
-  Exp//ISO (P. 93)
-   Custom (P. 94)
-  /Color/WB (P. 95)
-  Record/Erase (P. 96)
-  Movie (P. 97)
-  Built-In EVF (P. 97)
-   Utility (P. 98)



7

AF/MF

MENU →  → 

Option	Description	
AF Mode	Choose the AF mode. This is the same as the live control setting. You can set separate focusing methods for still photography mode and  mode.	73
Full-time AF	If [On] is selected, the camera will continue to focus even when the shutter button is not pressed halfway. Cannot be used when using a Four Thirds system lens.	—
AEL/AFL	Customize AF and AE lock.	98
Reset Lens	When set to [On], this resets the focus of the lens (infinity) each time the power is turned off. The focus of power zoom lenses is also reset.	—
BULB/TIME Focusing	Normally focus locks during the exposure when manual focus (MF) is selected. Select [On] to allow focusing using the focus ring.	—
Focus Ring	You can customize how the lens adjusts to the focal point by selecting the rotational direction of the focus ring.	—
MF Assist	When set to [On], you can automatically switch to zoom or peaking in manual focus mode by rotating the focus ring.	99
[] Set Home	Choose the AF target position that will be saved as the home position.  appears in the AF target selection display while you choose a home position.	—

Option	Description	
AF Illuminat.	Select [Off] to disable the AF illuminator.	—
Face Priority	Select the face priority AF mode. This is the same as the live control setting.	53
AF Area Pointer	If you select [Off], the AF target frame will not be displayed during confirmation.	—
C-AF Lock	When [AF Mode] (P. 73) is set to [C-AF], the AF does not adjust to sudden changes in subject distance. Depending on the sensitivity selected, the time it takes for the AF to adjust will change.	—

Option	Description	
Button Function	Choose the function assigned to the selected button. <div style="border: 1px solid black; padding: 5px; margin: 5px 0;"> [Fn1]Function, [Fn2]Function, [⊙]Function, [AEL]Function, [⊖]Function, [Q]Function, [▶]Function, [▽]Function, [⏪]Function, [B.Fn]Function, [B.Fn2]Function, [L.Fn]Function </div>	99
Dial Function	You can change the functions assigned to the rear dial and front dial.	—
Dial Direction	Choose the direction in which the dial is rotated to adjust shutter speed or aperture. Change the program shift direction.	—
Mode Dial Function	Customize the shooting mode set by the mode dial. You can apply saved Myset settings. [Myset1] - [Myset4] (P. 77) can be selected when the settings are registered.	—
Lever Function	You can use the positioning of the lever to change the function of the dials and button.	101
2+	If you select [Off], you cannot switch the button function even if you switch the lever.	—

Option	Description	
RIs Priority S	If [On] is selected, the shutter can be released even when the camera is not in focus. This option can be set separately for S-AF (P. 73) and C-AF (P. 73) modes.	—
RIs Priority C		
L fps	Choose the frame advance rates for and . Figures are the approximate maximums.	55
H fps		
+ IS Off	When set to [Off], the image stabilizer will turn on for sequential shooting.	—
Half Way RIs With IS	If set to [On], image stabilization operates when you press shutter button halfway.	—

Option	Description	
Lens I.S. Priority	If [On] is selected, priority is given to the lens function operation when using a lens with an image stabilization function.	—
Release Lag-Time	If [Short] is selected, the time lag between fully pressing the shutter button and the shot being taken can be shortened.*	—

* This will shorten the battery life. Also make sure that the camera is not subject to sharp impacts while in use. Such impacts may cause the monitor to stop displaying subjects. If this happens, turn the power off and on again.

Option	Description																																			
HDMI	[HDMI Out]: Selecting the digital video signal format for connecting to a TV via an HDMI cable. [HDMI Control]: Select [On] to allow the camera to be operated using remotes for TVs that support HDMI control.	101																																		
Video Out	Choose the video standard ([NTSC] or [PAL]) used in your country or region.	101																																		
Control Settings	Choose the controls displayed in each shooting mode. <table border="1" style="width: 100%; border-collapse: collapse;"> <thead> <tr> <th rowspan="2">Controls</th> <th colspan="4">Shooting mode</th> </tr> <tr> <th>P/A/S/M</th> <th>ⓐUTO</th> <th>ART</th> <th>SCN</th> </tr> </thead> <tbody> <tr> <td>Live Control (P. 30)</td> <td style="text-align: center;">✓</td> <td style="text-align: center;">✓</td> <td style="text-align: center;">✓</td> <td style="text-align: center;">✓</td> </tr> <tr> <td>Live SCP (P. 104)</td> <td style="text-align: center;">✓</td> <td style="text-align: center;">✓</td> <td style="text-align: center;">✓</td> <td style="text-align: center;">✓</td> </tr> <tr> <td>Live Guide (P. 28)</td> <td style="text-align: center;">—</td> <td style="text-align: center;">✓</td> <td style="text-align: center;">—</td> <td style="text-align: center;">—</td> </tr> <tr> <td>Art Menu</td> <td style="text-align: center;">—</td> <td style="text-align: center;">—</td> <td style="text-align: center;">✓</td> <td style="text-align: center;">—</td> </tr> <tr> <td>Scene Menu</td> <td style="text-align: center;">—</td> <td style="text-align: center;">—</td> <td style="text-align: center;">—</td> <td style="text-align: center;">✓</td> </tr> </tbody> </table>	Controls	Shooting mode				P/A/S/M	ⓐUTO	ART	SCN	Live Control (P. 30)	✓	✓	✓	✓	Live SCP (P. 104)	✓	✓	✓	✓	Live Guide (P. 28)	—	✓	—	—	Art Menu	—	—	✓	—	Scene Menu	—	—	—	✓	103
Controls	Shooting mode																																			
	P/A/S/M	ⓐUTO	ART	SCN																																
Live Control (P. 30)	✓	✓	✓	✓																																
Live SCP (P. 104)	✓	✓	✓	✓																																
Live Guide (P. 28)	—	✓	—	—																																
Art Menu	—	—	✓	—																																
Scene Menu	—	—	—	✓																																
Info Settings	Choose the information displayed when the INFO button is pressed. [▶ Info]: Choose the information displayed in full frame playback. [LV-Info]: Choose the information displayed when the camera is in shooting mode. [📷 Settings]: Choose the information displayed in index and calendar playback.	105, 106																																		
Displayed Grid	Select [📐], [📐], [📐], [📐] or [📐] to display a grid on the monitor.	—																																		
Picture Mode Settings	Display only the selected picture mode when a picture mode is selected.	—																																		
Histogram Settings	[Highlight]: Choose the lower bound for the highlight display. [Shadow]: Choose the upper bound for the shadow display.	105																																		
Mode Guide	Choose [Off] to not display help for the selected mode when the mode dial is rotated to a new setting.	18																																		
Live View Boost	If [On] is selected, priority will be given to making images clearly visible; the effects exposure compensation and other settings will not be visible in the monitor.	—																																		





Option	Description	
Frame Rate	Select [High] to reduce frame lag. However, the image quality may drop.	—
Art LV Mode	[mode1]: The filter effect is always displayed. [mode2]: Filter effects are not visible in the monitor while the shutter button is pressed halfway. Choose for a smooth display.	—
Expand LV Dyn. Range	If you select [Off], the viewfinder and monitor will be displayed normally during HDR shooting.	59
Flicker reduction	Reduce the effects of flicker under some kinds of lighting, including fluorescent lamps. When flicker is not reduced by the [Auto] setting, set to [50Hz] or [60Hz] in accordance with the commercial power frequency of the region where the camera is used.	—
LV Close Up Mode	[mode1]: Pressing the shutter button halfway cancels zoom. [mode2]: Zoom is not cancelled when the shutter button is pressed halfway.	54
Peaking Settings	You can switch the edge enhancement color between white and black.	—
Backlit LCD	If no operations are performed for the selected period, the backlight will dim to save battery power. The backlight will not dim if [Hold] is selected.	—
Sleep	The camera will enter sleep (energy saving) mode if no operations are performed for the selected period. The camera can be reactivated by pressing the shutter button halfway.	—
Auto Power Off	Sets camera to turn off after a set period.	—
 (Beep sound)	When set to [Off], you can turn off the beep sound that is emitted when the focus locks by pressing the shutter button.	—
USB Mode	Choose a mode for connecting the camera to a computer or printer. Choose [Auto] to display USB mode options every time the camera is connected.	—

Option	Description	
EV Step	Choose the size of the increments used when selecting shutter speed, aperture, exposure compensation, and other exposure parameters.	—
Noise Reduct.	This function reduces the noise that is generated during long exposures. [Auto]: Noise reduction is performed at slow shutter speeds, or when the internal temperature of the camera has risen. [On]: Noise reduction is performed with every shot. [Off]: Noise reduction off. <ul style="list-style-type: none"> • Noise reduction requires about twice the time needed to record the image. • Noise reduction turns off automatically during sequential shooting. • This function may not work effectively with some shooting conditions or subjects. 	41

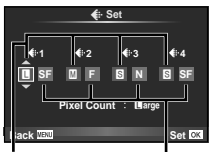
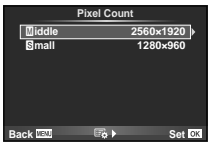
Option	Description	
Noise Filter	Choose the amount of noise reduction performed at high ISO sensitivities.	—
ISO	Set ISO sensitivity.	57
ISO Step	Select the increments available for choosing ISO sensitivity.	—
ISO-Auto Set	Choose the upper limit and default value used for ISO sensitivity when [Auto] is selected for ISO. [High Limit]: Choose the upper limit for auto ISO sensitivity selection. [Default]: Choose the default value for auto ISO sensitivity selection.	—
ISO-Auto	Choose the shooting modes in which [Auto] ISO sensitivity is available. [P/A/S]: Auto ISO sensitivity selection is available in all modes except M . ISO sensitivity is fixed at ISO200 in mode M . [All]: Auto ISO sensitivity selection is available in all modes.	—
Metering	Choose a metering mode according to the scene.	72
AEL Metering	Choose the metering method used for AE lock (P. 98). [Auto]: Use the currently selected metering method.	—
BULB/TIME Timer	Choose the maximum exposure for bulb and time photography.	—
BULB/TIME Monitor	Sets the monitor brightness when [BULB], or [TIME] is used. Also sets the brightness of the external electronic viewfinder.	—
Live BULB	Choose the display interval during shooting. Some restrictions apply. The frequency drops at high ISO sensitivities. Choose [Off] to disable the display. Tap the monitor or press the shutter button halfway to refresh the display.	—
Live TIME		—
Anti-Shock [↑]	Choose the delay between the shutter button being pressed and the shutter being released. This diminishes camera shake caused by vibrations. This feature is useful in situations such as microscope photography and astrophotography. It is also useful for sequential shooting (P. 55) and self timer photography (P. 55).	—

Option	Description	
X-Sync.	Choose the shutter speed used when the flash fires.	106
Slow Limit	Choose the slowest shutter speed available when a flash is used.	106
[Ⓢ]+[Ⓢ]	When set to [On], it will be added to the exposure compensation value and flash intensity control will be performed.	49, 71

Option	Description	
<p>← Set</p>	<p>You can select the JPEG image quality mode from combinations of three image sizes and four compression rates.</p> <ol style="list-style-type: none"> 1) Use <> to select a combination ([←1] – [←4]) and use Δ ▽ to change. 2) Press OK.  <p>Image size Compression rate</p>	70
<p>Pixel Count</p>	<ol style="list-style-type: none"> 1) Select [M]iddle or [S]mall and press ▷. 2) Choose a pixel count and press OK. 	70
<p>Shading Comp.</p>	<p>Choose [On] to correct peripheral illumination according to the type of lens.</p> <ul style="list-style-type: none"> • Compensation is not available for teleconverters or extension tubes. • Noise may be visible at the edges of photographs taken at high ISO sensitivities. 	—
<p>WB</p>	<p>Set the white balance. This is the same as the live control setting. You can also fine-tune the white balance for each mode. You can also make fine adjustments using white balance compensation on the super control panel (P. 24).</p>	56
<p>All [WB?]</p>	<p>[All Set]: Use the same white balance compensation in all modes except [CWB].</p> <p>[All Reset]: Set white balance compensation for all modes except [CWB] to 0.</p>	—
<p>WB AUTO Keep Warm Color</p>	<p>Select [Off] to eliminate “warm” colors from pictures taken under incandescent lighting.</p>	—
<p>⚡ +WB</p>	<p>Adjust white balance for use with a flash.</p>	—
<p>Color Space</p>	<p>You can select how colors are reproduced on the monitor or printer.</p>	—

Option	Description	👉
Quick Erase	If [On] is selected, pressing the  button in the playback display will immediately delete the current image.	—
RAW+JPEG Erase	Choose the action performed when a photograph recorded at a setting of RAW+JPEG is erased in single-frame playback (P. 33). [JPEG]: Only the JPEG copy is erased. [RAW]: Only the RAW copy is erased. [RAW+JPEG]: Both copies are erased. • Both the RAW and JPEG copies are deleted when selected images are deleted or when [All Erase] (P. 76) is selected.	70
File Name	[Auto]: Even when a new card is inserted, the file numbers are retained from the previous card. File numbering continues from the last number used or from the highest number available on the card. [Reset]: When you insert a new card, the folder numbers starts at 100 and the file name starts at 0001. If a card containing images is inserted, the file numbers start at the number following the highest file number on the card.	—
Edit Filename	Choose how image files are named by editing the portion of the filename highlighted below in gray. sRGB: Pmdd0000.jpg _____ Pmdd AdobeRGB: _mdd0000.jpg _____ mdd	—
Priority Set	Choose the default selection ([Yes] or [No]) for confirmation dialogs.	—
dpi Settings	Choose the print resolution.	—
Copyright Settings*	Add the names of the photographer and copyright holder to new photographs. Names can be up to 63 characters long. [Copyright Info.]: Select [On] to include the names of the photographer and copyright holder in the Exif data for new photographs. [Artist Name]: Enter the name of the photographer. [Copyright Name]: Enter the name of the copyright holder. <div style="border: 1px solid gray; padding: 10px;"> <ol style="list-style-type: none"> Highlight a character ① and press  to add the highlighted character to the name ②. Repeat Step 1 to complete the name, then highlight [END] and press . <ul style="list-style-type: none"> To delete a character, press the INFO button to place the cursor in the name area ②, highlight the character, and press . </div> 	—

* OLYMPUS does not accept liability for damages arising from disputes involving the use of [Copyright Settings]. Use at your own risk.

📽 Movie

MENU → ⚙ → 📽

Option	Description	👉
📽 Mode	Choose a movie record mode. This option can also be selected using the live control.	69
Movie 🗣	Choose [Off] to record silent movies. This option can also be selected using the live control.	74
Movie Effect	Choose [On] to enable movie effects in 📽 mode.	42
Wind Noise Reduction	Reduce wind noise during recording.	—
Recording Volume	Adjust microphone sensitivity. [Built-In 🗣]: Set the camera's internal microphone. [External 🗣]: Set when using the SEMA-1 (sold separately). [Line-In 🗣]: Set a microphone connected to the microphone jack.	—

📽 Built-In EVF

MENU → ⚙ → 📽

Option	Description	👉
Built-in EVF Style	Choose the viewfinder display style.	—
📄 Info Settings	Like the monitor, the viewfinder can be used to display histograms and highlights and shadows.	—
📄 Displayed Grid	Display a framing grid in the viewfinder. Choose from [📄], [📄], [📄], [📄], and [📄].	—
EVF Auto Switch	If [Off] is selected, the viewfinder will not turn on when you put your eye to the viewfinder. Use the [📄] button to choose the display.	—
EVF Adjust	Adjust viewfinder brightness and hue. Brightness is automatically adjusted when [EVF Auto Luminance] is set to [On].	—
📄 Half Way Level	If set to [Off], the level gauge will not be displayed when the shutter button is pressed halfway down. This is effective when [Built-in EVF Style] is set to [Style 1] or [Style 2].	—

Option	Description	📄
Pixel Mapping	The pixel mapping feature allows the camera to check and adjust the image pickup device and image processing functions.	141
Exposure Shift	Adjust optimal exposure separately for each metering mode. <ul style="list-style-type: none"> • This reduces the number of exposure compensation options available in the selected direction. • The effects are not visible in the monitor. To make normal adjustments to the exposure, perform exposure compensation (P. 49). 	—
AF Focus Adj.	You can minutely adjust the AF phase contrast focus point in ± 20 steps.	107
Warning Level	Choose the battery level at which the warning is displayed.	16
Battery Priority	Choose the primary power source when using a power battery holder.	129
Level Adjust	You can calibrate the angle of the level gauge. [Reset]: Resets adjusted values to the default settings. [Adjust]: Sets the current camera orientation as the 0 position.	—
Touch Screen Settings	Activate the touch screen. Choose [Off] to disable the touch screen.	—
Eye-Fi*	Enable or disable upload when using an Eye-Fi card. Displayed when an Eye-Fi card is inserted.	—

* Use in accordance with local regulations. Onboard airplanes and in other locations in which the use of wireless devices is prohibited, remove the Eye-Fi card from the camera, or select [Off] for [Eye-Fi]. The camera does not support the “endless” Eye-Fi mode.

AEL/AFL

MENU → ⚙️ → 📷 → [AEL/AFL]

Autofocus and metering can be performed by pressing the button to which AEL/AFL has been assigned. Choose a mode for each focus mode.





AEL/AFL

Mode		Shutter button function				Button function	
		Half-press		Full press		When holding down AEL/AFL	
		Focus	Exposure	Focus	Exposure	Focus	Exposure
S-AF	mode1	S-AF	Locked	—	—	—	Locked
	mode2	S-AF	—	—	Locked	—	Locked
	mode3	—	Locked	—	—	S-AF	—
C-AF	mode1	C-AF start	Locked	Locked	—	—	Locked
	mode2	C-AF start	—	Locked	Locked	—	Locked
	mode3	—	Locked	Locked	—	C-AF start	—
	mode4	—	—	Locked	Locked	C-AF start	—
MF	mode1	—	Locked	—	—	—	Locked
	mode2	—	—	—	Locked	—	Locked
	mode3	—	Locked	—	—	S-AF	—

MF Assist

MENU →  →  → [MF Assist]

This is a focus assist function for MF. When the focus ring is rotated, the edge of the subject is enhanced or a portion of the screen display is magnified. When you stop operating the focus ring, the screen returns to the original display.

Magnify	Magnifies a portion of the screen. The portion to be magnified can be set in advance using AF target.  [AF Area] (P.52)
Peaking	Displays clearly defined outlines with edge enhancement. You can select the enhancement color.  [Peaking Settings] (P.93)



Notes

- [Magnify] and [Peaking] can be displayed using button operations. The display is switched every time the button is pressed. Assign the switching function to one of the buttons in advance using [Button Function] (P. 99).

Cautions

- When Peaking is in use, the edges of small subjects tend to be enhanced more strongly. This is no guarantee of accurate focusing.

Button Function



MENU →  →  → [Button Function]

See the table below for the functions that can be assigned. The options available vary from button to button.

Button function items

[Fn1] Function / [Fn2] Function / [⊙] Function*¹ / [AEL] Function / [⊙] Function / [C] Function / [▷] Function / [▽] Function / [aB] Function / ([Direct Function]^{*2} / [L.Fn]^{*3}) / [B.Fn] Function / [B.Fn2] Function / [L.Fn] Function^{*4}



















*1 Not available in  mode.



*2 Assign the function to each of   .

*3 Choose the AF target.

*4 Choose the function assigned to the button on some lenses.

	Adjust exposure compensation.
ISO	Adjust ISO sensitivity.
WB	Adjust white balance.
AEL/AFL	AE lock or AF lock. The function changes according to the [AEL/AFL] setting. When AEL is selected, press the button once to lock the exposure and display AEL on the monitor. Press the button again to cancel the lock.
⊙ REC	Press the button to record a movie.

 (Preview)	Aperture is stopped down to the selected value while the button is pressed.
 (One-touch white balance)	The camera measures white balance when the button is pressed (P. 57).
 (AF area)	Choose the AF target.
 Home	Pressing the button selects the AF target position saved with  Set Home] (P. 90). The home AF target position is indicated by a  icon. Press the button again to return to AF target mode. If the camera is turned off when the home position is selected, the home position will be reset.
MF	Press the button to select manual focus mode. Press the button again to restore the previously selected AF mode.
RAW 	Press the button to toggle between JPEG and RAW+JPEG record modes.
Test Picture	Pictures taken while the button is pressed are displayed in the monitor but are not recorded to the memory card.
Myset1 – Myset4	Switches among the registered Myset settings when the button is pressed. Press the button again to return.
 / 	The button can be used to choose between  and  while the underwater case is attached. Press and hold the button to return to the previous mode. If this option is selected, the FL-LM2 will fire even when not raised. When using an ED12-50mmEZ lens with power zoom (E-ZOOM), the lens is automatically zoomed to the WIDE end or TELE end in accordance with  and  switching.
Live Guide	Press the button to display live guides.
 (Digital Tele-converter)	Press the button to turn digital zoom on or off.
Q (Magnify)	Press the button to display the zoom frame. Press again to magnify the image. Press and hold the button to turn off the zoom frame.
Peaking	Each press of the button switches the monitor between display/non-display. When Peaking is displayed, histogram and highlight/shadow display are not available.
AF Stop	Stop autofocus.
 / 	Choose a sequential shooting or self timer option.
	Choose a flash mode.
HDR	Switch to HDR with the saved settings.
BKT	Turns on BKT shooting using stored settings.
Multi Function	Press the button to recall the selected multi function*. When switching recalled functions, press the button while turning the dial.
 (Touch panel lock)	Each time the button is pressed, touch panel operation switches between enabled and disabled.
Electric Zoom	When using a lens with a power zoom function, after pressing the button, use the arrow pad for zooming operations.

* Multi function:  (Highlight&Shadow Control),  (Color Creator), Q (Magnify),  (Image Aspect)

☑ Lever Function

MENU → → → [Lever Function]

You can use the positioning of the lever to change the function of the dials and buttons.

Table of lever position and functions assigned to dial/buttons

Mode	When the lever position is set to 1	When the lever position is set to 2
Off	The lever function is not used.	The lever function is not used.
mode1	Dial functions are based on [Dial Function] settings.	Front dial: ISO Rear dial: White balance
mode2	Dial functions are based on [Dial Function] settings.	Front dial: White balance Rear dial: ISO
mode3	The button and Fn2 button functions are based on [Function] and [Fn2 Function] settings.	button: ISO Fn2 button: White balance
mode4	The button and Fn2 button functions are based on [Function] and [Fn2 Function] settings.	button: White balance Fn2 button: ISO
mode5	The AF modes assigned to the lever positions apply. When the lever position is set to 2, the default setting is [MF].	

Viewing camera images on TV

Use the separately sold cable with the camera to playback recorded images on your TV. Connect the camera to an HD TV using an HDMI cable to view high-quality images on a TV screen. When connecting devices using an AV cable, first set the camera's [Video Out] settings (P. 92).

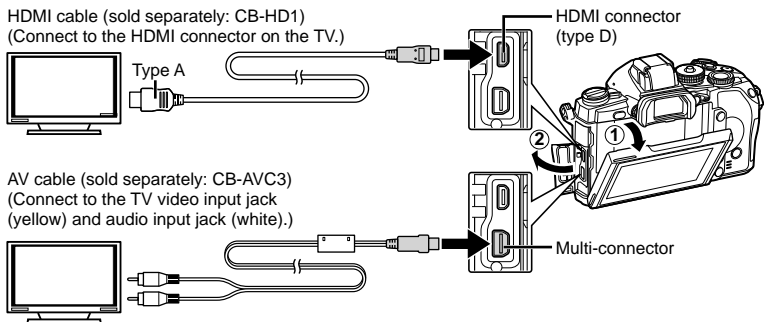

1 Connect the TV and camera and switch to TV input.

- The camera monitor turns off when the cable is connected.
- Press the  button when connecting via an AV cable.

Cautions

- For details on changing the input source of the TV, refer to the TV's instruction manual.
- Depending on the TV's settings, the displayed images and information may become cropped.
- If the camera is connected using both an AV and HDMI cables, it will assign priority to HDMI.
- If the camera is connected via an HDMI cable, you will be able to choose the digital video signal type. Choose a format that matches the input format selected with the TV.

1080i	Priority is given to 1080i HDMI output.
720p	Priority is given to 720p HDMI output.
480p/576p	480p/576p HDMI output. 576p is used when [PAL] is selected for [Video Out] (P. 92).

- You cannot shoot pictures or movies when the HDMI cable is connected.
- Do not connect the camera to other HDMI output devices. Doing so may damage the camera.
- HDMI output is not performed while connected via USB to a computer or printer.

Using the TV remote control

The camera can be operated by a TV remote control when connected to a TV that supports HDMI control.  [HDMI] (P. 92)



Notes

- You can operate the camera by following the operation guide displayed on the TV.
- During single-frame playback, you can display or hide the information display by pressing the "Red" button, and display or hide the index display by pressing the "Green" button.
- Some televisions may not support all features.

Choosing the control panel displays (📷 Control Settings)

Sets whether or not to display control panels for option selection when shooting using live view. When each screen is displayed, the displays can be switched as shown below.

How to display control panels

- 1 Press the  button and select live view shooting mode.

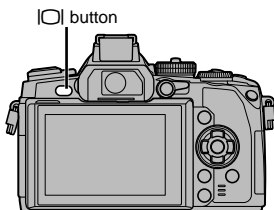

- 2 Press the  button while the control panel is displayed, then press the INFO button to switch the display.

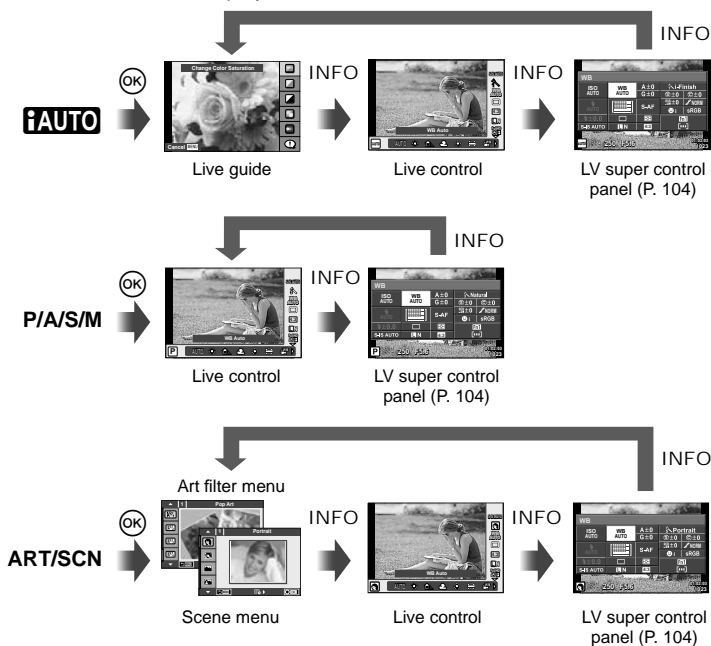

LV super control panel

This is the super control panel that is used for option setting when shooting using live view. Shooting setting statuses are displayed in a list. Select options using the arrow pad or touch operations to change the settings.

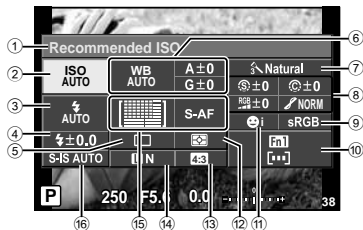

Settings that can be modified using super control panel

- | | | | |
|---|---|--------------|---------------------------------------|
| ① | Currently selected option | Gradation | P. 78 |
| ② | ISO sensitivity..... P. 57 | B&W Filter | P. 78 |
| ③ | Flash mode..... P. 50 | Picture tone | P. 79 |
| ④ | Flash intensity control..... P. 71 | ⑨ | Color space..... P. 95 |
| ⑤ | Sequential shooting/self-timer..... P. 55 | ⑩ | Button function assignment..... P. 99 |
| ⑥ | White balance..... P. 56 | ⑪ | Face priority..... P. 53 |
| | White balance compensation | ⑫ | Metering mode..... P. 72 |
| ⑦ | Picture mode..... P. 68 | ⑬ | Aspect ratio..... P. 69 |
| ⑧ | Sharpness | ⑭ | Record mode..... P. 70 |
| | Contrast | ⑮ | AF mode..... P. 73 |
| | Saturation | ⑯ | AF target..... P. 52 |
| | | ⑰ | Image stabilizer..... P. 66 |

ⓘ Cautions

- Not displayed in movie record mode.

1 Press the button when shooting using live view.

- Live control is displayed.

2 Press the INFO button to display the LV super control panel.

- Each time you press the INFO button, the display switches.

3 Touch the function you wish to set.

- The cursor appears over the touch function.

4 Press to select a settings value.

Notes

- Also available in the ART or SCN menu screens. Touch the icon of the function you wish to select.

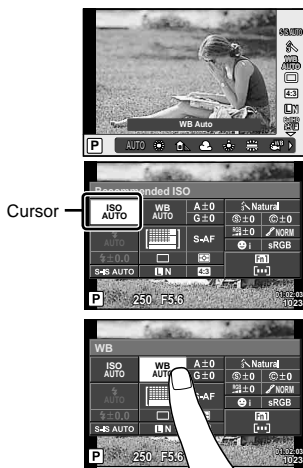

Adding information displays (Info Settings)

LV-Info (Shooting information displays)

Use [LV-Info] to add the following shooting information displays. The added displays are displayed by repeatedly pressing the INFO button during shooting. You can also choose to not show displays that appear at the default setting.



Histogram display



Highlight & Shadow display

Highlight & Shadow display

Areas above the upper limit of brightness for the image are shown in red, those below the lower limit in blue. [Info] [Histogram Settings] (P. 92)

Info (Playback information displays)

Use [Info] to add the following playback information displays. The added displays are displayed by repeatedly pressing the INFO button during playback. You can also choose to not show displays that appear at the default setting.

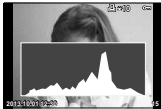

Histogram display



Highlight & Shadow display



Light box display

Light box display

Compare two images side-by-side. Press [OK] to select the image on the opposite side of the display.

- The base image is displayed on the right. Use [Left/Right] to select an image and press [OK] to move the image to the left. The image to be compared to the image on the left can be selected on the right. To choose a different base image, highlight the right frame and press [OK].
- Press Fn1 to zoom in on the current image. To change the zoom ratio, turn the rear dial. When zooming in, you can use [Up/Down/Left/Right] to scroll to other areas of the image, and the front dial to select between images.



Settings (Index/calendar display)

You can add an index display with a different number of frames and calendar display using [Settings]. The additional screens are displayed by turning the rear dial during playback.

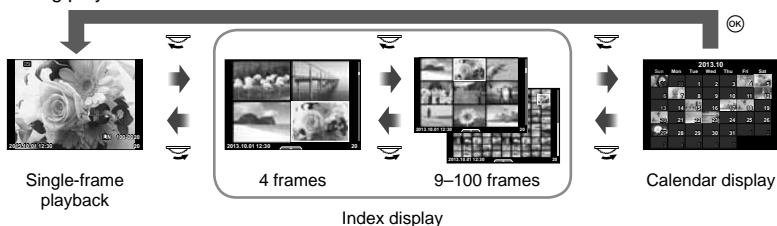

Shutter speeds when the flash fires automatically [X-Sync.] [Slow Limit]

You can set shutter speed conditions for when the flash fires.

Shooting mode	Flash timing (synchronous)	Upper limit	Lower limit
P	The slower of $1/(\text{lens focal length} \times 2)$ and the [X-Sync.] settings	[X-Sync.] setting*	[Slow Limit] setting
A			No lower limit
S	The set shutter speed	[X-Sync.] setting*	No lower limit
M			

* 1/320 sec when using the supplied external flash FL-LM2, and 1/125 sec when using a commercially available specialty flash.

AF focus adjustments

You can adjust the phase contrast AF focal point in a range of ± 20 steps (-: Near distance, +: Far distance). Normally there is no need to change the settings.

1 Select [AF Focus Adj.] using the  tab in the  custom menu and press the  button.

- Select a setting and press .



[OFF]: AF minute adjustments are not performed.

[Default Data]: Minute adjustments for all lenses are registered and applied. Adjustments are not applied to individually registered lenses.

[Lens Data]: Adjustments are made for each lens; adjustment values for a maximum of 20 lenses can be registered.



When [Default Data] is selected



2 Select adjustment values using  .



- Registration is ended when  is pressed.
- Before pressing , press the shutter button and confirm the settings by shooting an actual photograph.



When [Lens Data] is selected

2 Select [Create Lens Data Set] and press .

- If data is already registered, [Lens Data] will be displayed. You can confirm or delete information by selecting it using   and pressing .

3 Select an AF target to be minutely adjusted and set the adjustment values using  .

- Repeat your AF target selection and input of adjustment values; when finished, press .
- When using the zoom lens, you can record the adjustment values for each of Far distance and Near distance.
- Before pressing , press the shutter button and confirm the settings by shooting an actual photograph.

4 Press the MENU button to return to the  custom menu, select [Lens Data] in [AF Focus Adj.] on the  tab, and press .

Tips

- On the screen displaying the actual photograph shot to confirm the settings, you can check by turning the front dial to zoom in on the image.

Cautions

- Depending on the adjustments and the lens, the camera may not be able to focus at far or near distances.

Using the accessory port menus

You can make settings relating to devices connected via the accessory port.

Before using the accessory port menus

The Accessory Port menu is only available when the appropriate option is selected for the [*/☰ Menu Display] item in the setup menu.

- 1 Press the MENU button to display the menus, and display the **f** (Setup Menu) tab.
- 2 Select [*/☰ Menu Display] and set [☰ Menu Display] to [On].
 - The ☰ (Accessory Port Menu) tab will be displayed in the menu.

Accessory Port Menu

- A** OLYMPUS PENPAL Share (P. 110)
- B** OLYMPUS PENPAL Album (P. 111)
- C** Electronic Viewfinder (P. 111)

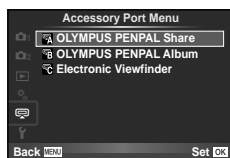

Using OLYMPUS PENPAL

The optional OLYMPUS PENPAL can be used to upload pictures to, and receive pictures from, Bluetooth devices or other cameras connected to an OLYMPUS PENPAL. Visit the OLYMPUS website for more information on Bluetooth devices.

■ Sending images

Resize and upload JPEG images to another device. Before sending images, make sure that the receiving device is set to the mode for receiving data.

- 1 Display the picture you wish to send full frame and press **OK**.
- 2 Select [Send A Picture] and press **OK**.
 - Select [Search] and press **OK** in the next dialog. The camera searches for and displays Bluetooth devices in range or in [Address Book].
- 3 Select the destination and press **OK**.
 - The image will be uploaded to the receiving device.
 - If prompted to provide a PIN code, enter 0000 and press **OK**.



■ Receiving images/adding a host



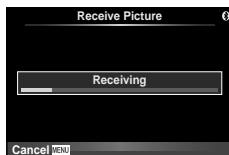

Connect to the transmitting device and download JPEG images.

- 1 Select [OLYMPUS PENPAL Share] in **Accessory Port Menu** (P. 108).
- 2 Select [Please Wait] and press **OK**.
 - Perform operations for sending images on the sending device.
 - Transmission will start and a [Receive Picture Request] dialog will be displayed.
- 3 Select [Accept] and press **OK**.
 - The image will be downloaded to the camera.
 - If prompted to provide a PIN code, enter 0000 and press **OK**.



■ Editing the address book

The OLYMPUS PENPAL can store host information. You can assign names to hosts or delete host information.

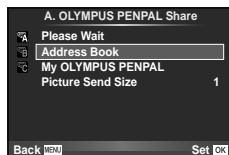

- 1 Select [OLYMPUS PENPAL Share] in  Accessory Port Menu (P. 108).
- 2 Select [Address Book] and press .
- 3 Select [Address List] and press .
 - The names of existing hosts are listed.
- 4 Select the host you wish to edit and press .



Deleting hosts







Select [Yes] and press .

Editing host information

Press  to display host information. To change the host name, press  again and edit the current name in the rename dialog.

■ Creating albums

Your favorite JPEG pictures can be resized and copied to an OLYMPUS PENPAL.



- 1 Display the picture you wish to copy full frame and press .
- 2 Select [ → ] and press .
 - To copy images from an OLYMPUS PENPAL to the memory card, select [ → ] and press .





Cautions

- The OLYMPUS PENPAL can be used only in the region in which it was purchased. Depending on the areas, the usage may infringe the wave regulations and may be subject to its penalty.



OLYMPUS PENPAL Share

MENU →  → 

Option	Description	
Please Wait	Receive images and add hosts to the address book.	109
Address Book	[Address List]: View the hosts that have been saved to the address book. [New Pairing]: Add a host to the address book. [Search Timer]: Choose how long the camera searches for a host.	110
My OLYMPUS PENPAL	Display information for your OLYMPUS PENPAL, including the name, address, and supported services. Press  to edit the device name.	110
Picture Send Size	Choose the size at which images are transmitted. [Size 1: Small]: Images are sent at a size equivalent to 640 × 480. [Size 2: Large]: Images are sent at a size equivalent to 1920 × 1440. [Size 3: Medium]: Images are sent at a size equivalent to 1280 × 960.	109

Option	Description	
Copy All	All images and sound files are copied between the SD card and OLYMPUS PENPAL. Copied images are resized according to the option selected for picture copy size.	110
Reset Protect	Remove protection from all pictures in the OLYMPUS PENPAL album.	110
Album Mem. Usage	Show the number of pictures currently in the album and the number of additional pictures that can be stored at [Size 2: Medium].	110
Album Mem. Setup	[All Erase]: Delete all pictures in the album. [Format Album]: Format the album.	110
Picture Copy Size	Choose the size at which images are copied. [Size 1: Large]: Copied images are not resized. [Size 2: Medium]: Images are copied at a size equivalent to 1920 x 1440.	110

C Electronic Viewfinder

Option	Description		
EVF Adjust	Adjust the brightness and the color temperature of optional external viewfinders. The selected color temperature is also used in the monitor during playback. Use ◀▶ to select color temperature (☼) or brightness (☼) and use ▲▼ to choose from values between [+7] and [-7].		—
EVF Auto Switch	Sets whether to automatically switch the display away from the monitor when using the VF-4 external electronic viewfinder. When set to [Off], pressing the  button on the external viewfinder switches the display between the viewfinder and the monitor. When set to [On], the display automatically switches to VF-4 when you look through it.	134	

8 Printing pictures

Print reservation (DPOF)

You can save digital “print orders” to the memory card listing the pictures to be printed and the number of copies of each print. You can then have the pictures printed at a print shop that supports DPOF or print the pictures yourself by connecting the camera directly to a DPOF printer. A memory card is required when creating a print order.

Creating a print order

- 1 Press **[OK]** during playback and select **[P]**.
- 2 Select **[P]** or **[ALL]** and press **[OK]**.

Individual picture

Press **[<|>]** to select the frame that you want to set as print reservation, then press **[Δ]** **[▽]** to set the number of prints.

- To set print reservation for several pictures, repeat this step. Press **[OK]** when all the desired pictures have been selected.

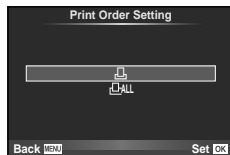

All pictures

Select **[ALL]** and press **[OK]**.

- 3 Select the date and time format and press **[OK]**.

No	The pictures are printed without the date and time.
Date	The pictures are printed with the shooting date.
Time	The pictures are printed with the shooting time.



- 4 Select **[Set]** and press **[OK]**.

⚠ Cautions

- The camera cannot be used to modify print orders created with other devices. Creating a new print order deletes any existing print orders created with other devices.
- Print orders cannot include 3D photos, RAW images, or movies.

Removing all or selected pictures from the print order

You can reset all print reservation data or just the data for selected pictures.

- 1 Press **[OK]** during playback and select **[P]**.

- 2 Select [F5] and press **OK**.
 - To remove all pictures from the print order, select [Reset] and press **OK**.
To exit without removing all pictures, select [Keep] and press **OK**.
- 3 Press **◀▶** to select images you wish to remove from the print order.
 - Use **▽** to set the number of prints to 0. Press **OK** once you have removed all the desired pictures from the print order.
- 4 Select the date and time format and press **OK**.
 - This setting is applied to all frames with print reservation data.
- 5 Select [Set] and press **OK**.

Direct printing (PictBridge)

By connecting the camera to a PictBridge-compatible printer with the USB cable, you can print out recorded pictures directly.

- 1 Connect the camera to the printer using the supplied USB cable and turn the camera on.

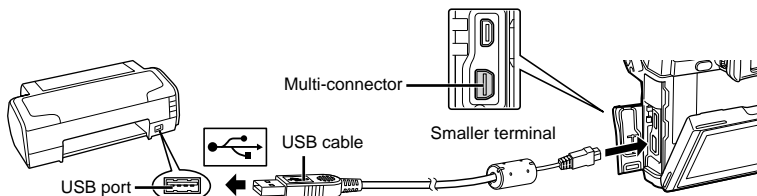

- Use a fully charged battery for printing.
- When the camera is turned on, a dialog should be displayed in the monitor prompting you to choose a host. If it is not, select [Auto] for [USB Mode] (P. 93) in the camera custom menus.

- 2 Use **△▽** to select [Print].
 - [One Moment] will be displayed, followed by a print-mode selection dialog.
 - If the screen is not displayed after a few minutes, disconnect the USB cable and start again from Step 1.

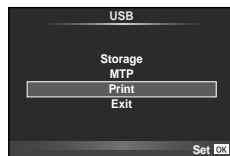

Proceed to "Custom printing" (P. 114).

⚠ Cautions

- 3D photos, RAW images, and movies cannot be printed.

Easy printing

Use the camera to display the picture you wish to print before connecting the printer via the USB cable.

- 1 Use \triangleleft \triangleright to display the pictures you want to print on the camera.
- 2 Press \triangleright .
 - The picture selection screen appears when printing is completed. To print another picture, use \triangleleft \triangleright to select the image and press \odot .
 - To exit, unplug the USB cable from the camera while the picture selection screen is displayed.

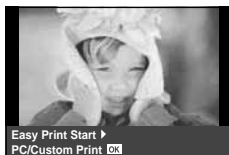

Custom printing

- 1 Follow the operation guide to set a print option.

Selecting the print mode

Select the type of printing (print mode). The available print modes are as shown below.

Print	Prints selected pictures.
All Print	Prints all the pictures stored in the card and makes one print for each picture.
Multi Print	Prints multiple copies of one image in separate frames on a single sheet.
All Index	Prints an index of all the pictures stored in the card.
Print Order	Prints according to the print reservation you made. If there is no picture with print reservation, this is not available.

Setting the print paper items

This setting varies with the type of printer. If only the printer's STANDARD setting is available, you cannot change the setting.

Size	Sets the paper size that the printer supports.
Borderless	Selects whether the picture is printed on the entire page or inside a blank frame.
Pics/Sheet	Selects the number of pictures per sheet. Displayed when you have selected [Multi Print].

Selecting pictures you want to print

Select pictures you want to print. The selected pictures can be printed later (single-frame reservation) or the picture you are displaying can be printed right away.



Print (OK)	Prints the currently displayed picture. If there is a picture that [Single Print] reservation has already been applied to, only that reserved picture will be printed.
Single Print (▲)	Applies print reservation to the currently displayed picture. If you want to apply reservation to other pictures after applying [Single Print], use <Left> to select them.
More (▼)	Sets the number of prints and other items for the currently displayed picture, and whether or not to print it. For operation, refer to "Setting printing data" in the next section.

Setting printing data

Select whether to print printing data such as the date and time or file name on the picture when printing. When the print mode is set to [All Print] and [Option Set] is selected, the following options appears.

	Sets the number of prints.
Date	Prints the date and time recorded on the picture.
File Name	Prints the file name recorded on the picture.
	Trims the picture for printing. Use the dial to choose the crop size and ▲ ▼ <Left> to position the crop.

2 Once you have set the pictures for printing and printing data, select [Print], then press **OK**.

- To stop and cancel printing, press **OK**. To resume printing, select [Continue].

■ Cancelling printing

To cancel printing, highlight [Cancel] and press **OK**. Note that any changes to the print order will be lost; to cancel printing and return to the previous step, where you can make changes to the current print order, press MENU.

Installing the PC software

■ Windows

1 Insert the supplied CD in a CD-ROM drive.

Windows XP

- A "Setup" dialog will be displayed.

Windows Vista/Windows 7/Windows 8

- An Autorun dialog will be displayed. Click "OLYMPUS Setup" to display the "Setup" dialog.



⚠ Cautions

- If the "Setup" dialog is not displayed, select "My Computer" (Windows XP) or "Computer" (Windows Vista/Windows 7) from the start menu. Double-click the CD-ROM (OLYMPUS Setup) icon to open the "OLYMPUS Setup" window and then double-click "LAUNCHER.EXE".
- If a "User Account Control" dialog is displayed, click "Yes" or "Continue".

2 Follow the on-screen instructions on your computer.

⚠ Cautions

- If nothing is displayed on the camera screen even after connecting the camera to the computer, the battery may be exhausted. Use a full-charged battery.

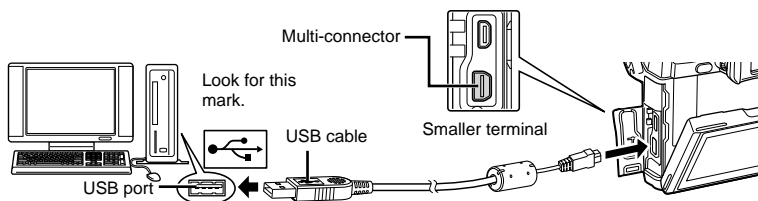

⚠ Cautions

- When the camera is connected to another device via USB, a message will be displayed prompting you to choose a connection type. Select [Storage].

3 Register your Olympus product.

- Click the “Registration” button and follow the on-screen instructions.

4 Install OLYMPUS Viewer 3.

- Check the system requirements before beginning installation.
- Click the “OLYMPUS Viewer 3” button and follow the on-screen instructions to install the software.

Operating System	Windows XP (Service Pack 2 or later)/Windows Vista/Windows 7/Windows 8
Processor	Pentium 4 1.3 GHz or better (Core2Duo 2.13 GHz or better required for movies)
RAM	1 GB or more (2 GB or more recommended)
Free Hard Drive Space	3 GB or more
Monitor Settings	1024 x 768 pixels or more Minimum 65,536 colors (16,770,000 colors recommended)

- See online help for information on using the software.

■ Macintosh

1 Insert the supplied CD in a CD-ROM drive.

- The disk contents should automatically be displayed in the Finder. If they are not, double-click the CD icon on the desktop.
- Double-click the “Setup” icon to display the “Setup” dialog.



2 Install OLYMPUS Viewer 3.

- Check the system requirements before beginning installation.
- Click the “OLYMPUS Viewer 3” button and follow the on-screen instructions to install the software.



Operating System	Mac OS X v10.5–v10.8
Processor	Intel Core Solo/Duo 1.5 GHz or better (Core2Duo 2 GHz or better required for movies)
RAM	1 GB or more (2 GB or more recommended)
Free Hard Drive Space	3 GB or more
Monitor Settings	1024 x 768 pixels or more Minimum 32,000 colors (16,770,000 colors recommended)

- Other languages can be selected from the language combo box. For information on using the software, see online help.

Copying pictures to a computer without OLYMPUS Viewer 3

Your camera supports the USB Mass Storage Class. You can transfer images to a computer by connecting the camera to the computer with the provided USB cable. The following operating systems are compatible with the USB connection:

Windows: Windows XP Home Edition/
Windows XP Professional/
Windows Vista/Windows 7/Windows 8

Macintosh: Mac OS X v.10.3 or later

- 1 Turn the camera off and connect it to the computer.
 - The location of the USB port varies with the computer. For details, refer to your computer's manual.
- 2 Turn on the camera.
 - The selection screen for the USB connection is displayed.
- 3 Press Δ ∇ to select [Storage]. Press \odot .

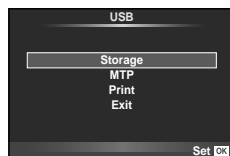

- 4 The computer recognizes the camera as a new device.

ⓘ Cautions

- If you are using Windows Photo Gallery for Windows Vista, Windows 7 or Windows 8, choose [MTP] in Step 3.
- Data transfer is not guaranteed in the following environments, even if your computer is equipped with a USB port.
 - Computers with a USB port added by means of an extension card, etc.
 - Computers without a factory-installed OS
 - Home-built computers
- Camera controls cannot be used while the camera is connected to a computer.
- If the dialog shown in Step 2 is not displayed when the camera is connected to a computer, select [Auto] for [USB Mode] (P. 93) in the camera custom menus.

Using the camera wireless LAN function

You can use the camera wireless LAN function to connect to a smartphone over a wireless network.

- View and transfer images stored on the camera card.
- Add position information to image using the smartphone position information.
- Operate the camera using your smartphone.

For these operations, a smartphone with the smartphone app installed is necessary. See the Olympus website for details on "OI.Share", the smartphone app.

Cautions

- Before using the wireless LAN function, read "Precautions when using the wireless LAN function" (P. 153).
- If using the wireless LAN function in a country outside the region where the camera was purchased, there is a risk that the camera will not conform to the wireless communication regulations of that country. Olympus will not be held responsible for any failure to meet such regulations.
- As with any wireless communication, there is always a risk of interception by a third party.
- The wireless LAN function on the camera cannot be used to connect to a home or public access point.

■ Preparing your smartphone

Install "OI.Share", the smartphone app, and then start OI.Share on your smartphone.

■ Preparing your camera



There are 2 methods for the wireless LAN connection.

Private	Connects using a preset password every time. Use this method when you always connect to the same devices, such as your smartphone to transfer images.
One-Time	Connects using a different password each time. Use this method for one-time connection, such as when you wish to share selected images among a number of friends.



Select the wireless LAN connection method in advance.  "Setting up a wireless LAN connection (Wi-Fi Settings)" (P. 89)

■ Private connection

The following procedure can be used to connect.

- 1** Select [Connection to Smartphone] in the  Playback Menu, and press .
- 2** Follow the operation guide displayed on the monitor, pressing  to proceed.
 - The SSID, password and QR code are displayed on the monitor.
- 3** Enter the SSID and password into your smartphone.
 - If you use OI.Share on your smartphone to read the QR code, the SSID and password are entered automatically.
 - From the second time you connect, connection will be performed automatically.
 - An index of images on the camera is displayed in OI.Share on your smartphone.

■ One-time connection

1 Select [Connection to Smartphone] in the  Playback Menu, and press .

- The SSID, password and QR code are displayed on the monitor.

2 Enter the SSID and password into your smartphone.

- If you use OI.Share on your smartphone to read the QR code, the SSID and password are entered automatically.
- From the second time you connect, a confirmation message first will be displayed asking if you wish to change your password.

■ To end the connection

1 Press MENU on the camera or touch [Stop] on the monitor screen.

- You can also end the connection with OI.Share or by turning off your camera.
- The connection ends.

 Cautions

- Combination of the wireless LAN function with OLYMPUS PENPAL, an Eye-Fi card, or similar may result in a significant reduction in camera performance.
- The wireless LAN antenna is contained in the camera grip. Where possible, avoid covering the antenna with your hands.
- During wireless LAN connection, the battery will run down faster. If the battery is running low, the connection may be lost during a transfer.
- Connection may be difficult or slow in proximity to devices that generate magnetic fields, static electricity or radio waves, such as near microwaves, cordless telephone.

Things you can do with OI.Share

- Synchronize the time and date on your camera with your smartphone

Synchronize the time and date on your smartphone and camera to allow position information to be added to images on your camera. Start time synchronization in OI.Share.

- It may take a minute or so for the camera time to synchronize.

- Adding smartphone position information to images

1 Start position information recording in OI.Share.

- Your smartphone will log position information at a predetermined interval.

2 End the connection.

- The camera is now ready for shooting.

3 Stop position information recording in OI.Share when position information is no longer required.

4 Start [Connection to Smartphone] in your camera.

5 Start sending position information in OI.Share.

- The position information will be added to images on the memory card.  is displayed on images to which position information has been added.

Cautions

- Position information cannot be added to movies.

- Sharing images

To share images, set a [Share Order] on the images you wish to share.

1 Playback images and set [Share Order] (P. 62).

2 Use [One-Time] to set up a Wi-Fi connection.

- Operating the camera

You can shoot pictures with the camera by performing operations on your smartphone. This function is only available when connected with [Private].

1 Start [Connection to Smartphone] in your camera.

- You can also connect by touching  on the shooting screen.
- Shooting modes **P/A/S/M/FAUTO** can be used.

2 Shoot pictures using your smartphone.

Cautions

- Log position information is only available when using a smartphone with a GPS function.
- Not all camera functions are available over the wireless LAN connection.

Battery and charger

- Use the single Olympus lithium-ion battery. Use only genuine OLYMPUS rechargeable batteries.
- The camera's power consumption varies widely with usage and other conditions.
- As the following consume a lot of power even without shooting, the battery will be drained quickly.
 - Performing auto focus repeatedly by pressing the shutter button halfway in shooting mode.
 - Displaying images on the monitor for a prolonged period.
 - When connected to a computer or printer.
- When using a drained battery, the camera may turn off without the low battery warning being displayed.
- The battery will not be fully charged at the time of purchase. Charge the battery using the provided charger before use.
- The normal charging time using the provided charger is approximately 3 hours 30 minutes (estimated).
- Do not attempt to use chargers not specifically designated for use with the supplied battery, or to use batteries not specifically designated for use with the supplied charger.

⚠ Cautions

- There is a risk of explosion if the battery is replaced with the incorrect battery type. Dispose of the used battery following the instructions "Battery Handling Precautions" (P. 152).

Using an optional AC adapter

The camera can be connected to an optional AC-3 AC adapter via a power battery holder (HLD-7). Other adapters can not be used. The power cable supplied with the AC adapter can not be used with other products.

Using your charger abroad

- The charger can be used in most home electrical sources within the range of 100V to 240V AC (50/60Hz) around the world. However, depending on the country or area you are in, the AC wall outlet may be shaped differently and the charger may require a plug adapter to match the wall outlet. For details, ask at your local electrical shop or travel agent.
- Do not use commercially available travel adapters as the charger may malfunction.

Usable cards

In this manual, all storage devices are referred to as “cards.” The following types of SD memory card (commercially available) can be used with this camera: SD, SDHC, SDXC, and Eye-Fi. For the latest information, please visit the Olympus website.



SD card write protect switch

The SD card body has a write protect switch. If you set the switch to the “LOCK” side, you will not be able to write to the card, delete data or format. Return the switch to the unlock position enable writing.



ⓘ Cautions

- The data in the card will not be erased completely even after formatting the card or deleting the data. When discarding, destroy the card to prevent leakage of personal information.
- Use the Eye-Fi card in compliance with the laws and regulations of the country where the camera is used. Remove the Eye-Fi card from the camera or disable the card functions in airplanes and other locations where use is prohibited. ⓘ [Eye-Fi] (P. 98)
- The Eye-Fi card may become hot during use.
- When using an Eye-Fi card, the battery may run out faster.
- When using an Eye-Fi card, the camera may function more slowly.

Record mode and file size/number of storable still pictures

The file size in the table is approximate for files with a 4:3 aspect ratio.

Record mode	Number of pixels (Pixel Count)	Compression	File format	File size (MB)	Number of storable still pictures*
RAW	4608x3456	Loss-less compression	ORF	Approx. 17	41
L ^S F		1/2.7		Approx. 11	79
L ^F		1/4		Approx. 7.5	114
L ^N		1/8		Approx. 3.5	248
L ^B		1/12		Approx. 2.4	369
M ^S F	3200x2400	1/2.7	JPEG	Approx. 5.6	155
M ^F		1/4		Approx. 3.4	257
M ^N		1/8		Approx. 1.7	508
M ^B		1/12		Approx. 1.2	753
M ^S F		1/2.7		Approx. 3.2	271
M ^F	2560x1920	1/4	JPEG	Approx. 2.2	398
M ^N		1/8		Approx. 1.1	782
M ^B		1/12		Approx. 0.8	1151
M ^S F		1/2.7		Approx. 1.8	476
M ^F		1/4		Approx. 1.3	701
M ^N	1920x1440	1/8	JPEG	Approx. 0.7	1356
M ^B		1/12		Approx. 0.5	1968
M ^S F		1/2.7		Approx. 1.3	678
M ^F		1/4		Approx. 0.9	984
M ^N		1/8		Approx. 0.5	1906
M ^B	1600x1200	1/12	JPEG	Approx. 0.4	2653
S ^S F		1/2.7		Approx. 0.9	1034
S ^F		1/4		Approx. 0.6	1488
S ^N		1/8		Approx. 0.4	2773
S ^B		1/12		Approx. 0.3	3813
S ^S F	1024x768	1/2.7	JPEG	Approx. 0.6	1564
S ^F		1/4		Approx. 0.4	2260
S ^N		1/8		Approx. 0.3	4068
S ^B		1/12		Approx. 0.2	5547
S ^S F		1/2.7		Approx. 0.3	3589
S ^F	640x480	1/4	JPEG	Approx. 0.2	5085
S ^N		1/8		Approx. 0.2	7627
S ^B		1/12		Approx. 0.1	10170
S ^S F		1/2.7		Approx. 0.3	3589

*Assumes a 1GB SD card.

ⓘ Cautions

- The number of storable still pictures may change according to the subject, whether or not print reservations have been made, and other factors. In certain instances, the number of storable still pictures displayed on the monitor will not change even when you take pictures or erase stored images.
- The actual file size varies according to the subject.
- The maximum number of storable still pictures displayed on the monitor is 9999.
- For the available recording time for movies, see the Olympus website.

Choose a lens according to the scene and your creative intent. Use lenses designed exclusively for the Micro Four Thirds system and bearing the M.ZUIKO DIGITAL label or the symbol shown at right. With an adapter, you can also use Four Thirds System and OM System lenses.



⚠ Cautions

- When you attach or remove the body cap and lens from the camera, keep the lens mount on the camera pointed downward. This helps prevent dust and other foreign matter from getting inside the camera.
- Do not remove the body cap or attach the lens in dusty places.
- Do not point the lens attached to the camera toward the sun. This may cause the camera to malfunction or even ignite due to the magnifying effect of sunlight focusing through the lens.
- Be careful not to lose the body cap and rear cap.
- Attach the body cap to the camera to prevent dust from getting inside when no lens is attached.

M.ZUIKO DIGITAL lens specifications

■ Names of parts

- ① Front cap
- ② Filter mount thread
- ③ Focus ring
- ④ Zoom ring (zoom lenses only)
- ⑤ Mount index
- ⑥ Rear cap
- ⑦ Electrical contacts
- ⑧ UNLOCK switch (only retractable lenses)
- ⑨ Decoration ring (only some lenses, remove when attaching a lens hood)

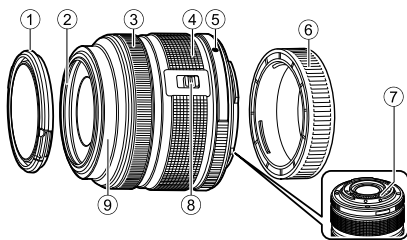

- Using power zoom lenses with macro functions (ED12-50mm f3.5-6.3EZ)

Lens operation is determined by the position of the zoom ring.

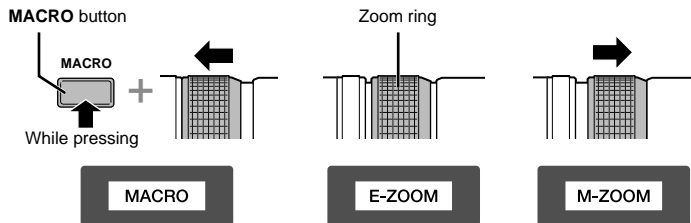

E-ZOOM (Power Zoom)	Rotate the zoom ring for power zoom. Zoom speed is determined by the amount of rotation.
M-ZOOM (Manual Zoom)	Rotate the zoom ring to zoom in and out.
MACRO (Macro Photography)	To photograph subjects at a range of 0.2 to 0.5 m, press the MACRO button and slide the zoom ring forward. Zoom is not available.

- The role of the **L-Fn** button can be selected in the camera custom menu.
- MF (manual focus) control (17mm f1.8, ED12mm f2.0 (Snapshot focus), ED12-40mm f2.8PRO)
Slide the focus ring in the direction of the arrow to change the focus method.

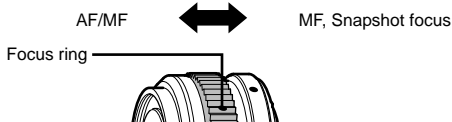

With snapshot focus, a distance is set using the focus ring based on the shooting distance. The camera focuses over a depth of field corresponding to the set aperture value.

- We recommend setting the aperture to F5.6 or above with a 17mm f1.8 or an ED12mm f2.0.
- You can shoot at the selected distance irrespective of the AF mode on the camera.
- Use the distance scale only as a guide.

■ Cap lens control (BCL-1580)

Use the MF lever to open and close the lens barrier, and adjust the focus between infinity and close-up.

- There is no data communication between camera and lens.
- Some functions of the camera cannot be used.
- Set the focal distance to 15 mm for the image stabilization function.

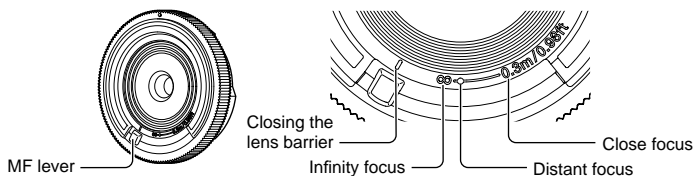

■ Lens and camera combinations

Lens	Camera	Attachment	AF	Metering
Micro Four Thirds system lens	Micro Four Thirds system camera	Yes	Yes	Yes
Four Thirds system lens		Attachment possible with mount adapter	Yes*1	Yes
OM System lenses			No	Yes*2
Micro Four Thirds system lens	Four Thirds System Camera	No	No	No

*1 When recording movies, you cannot use [C-AF] or [C-AF+TR] in [AF mode]. Also, AF is not operational when recording movies.

*2 Accurate metering is not possible.

■ Main lens specifications

Items	ED12-40mm f2.8PRO	ED40-150mm f4.0-5.6R	ED14-150mm f4.0-5.6
Mount	Micro Four Thirds mount		
Focal length	12–40 mm	40–150 mm	14–150 mm
Max. aperture	f/2.8	f/4.0–5.6	f/4.0–5.6
Image angle	84.1°–30.3°	30.3°–8.2°	75°–8.2°
Lens configuration	9 groups, 14 lenses	10 groups, 13 lenses	11 groups, 15 lenses
Iris control	f/2.8–22	f/4.0–22	f/4.0–22
Shooting range (Focal length)	0.2 m–∞	0.9 m–∞	0.5 m–∞
Focus adjustment	AF/MF, snapshot focus	AF/MF switching	
Weight (excluding hood and cap)	382 g	190 g	260 g
Dimensions (Max. diameter x length)	ø69.9x84 mm	ø63.5x83 mm	ø63.5x83 mm
Filter mount thread diameter	62 mm	58 mm	58 mm
Lens hood	Supplied*	LH-61D	LH-61C

Items	ED12-50mm f3.5-6.3EZ	17mm f1.8	BCL-1580 (15mm f8)
Mount	Micro Four Thirds mount		
Focal length	12–50 mm	17 mm	15 mm
Max. aperture	f/3.5–6.3	f/1.8	f/8
Image angle	84°–24°	64°	72°
Lens configuration	9 groups, 10 lenses	6 groups, 9 lenses	3 groups, 3 lenses
Iris control	f/3.5–22	f/1.8–22	Fixed to f/8
Shooting range (Focal length)	0.35 m–∞ 0.2 m–0.5 m (macro mode)	0.25 m–∞	0.30 m–∞
Focus adjustment	AF/MF switching	AF/MF, snapshot focus	MF
Weight (excluding hood and cap)	212 g	120 g	22 g
Dimensions (Max. diameter x length)	ø57x83 mm	ø57.5x35.5 mm	ø56x9 mm
Filter mount thread diameter	52 mm	46 mm	–
Lens hood	LH-55B	LH-48B	–

* To remove the ED12-40mm lens hood, turn the lens hood while pressing in the buttons on both sides.

ⓘ Cautions

- Edges of pictures may be cut off if more than one filter is used or if a thick filter is used.

12 Using separately sold accessories

Power Battery Holder (HLD-7)

You can extend camera usage time by using the power battery holder with the camera's battery. You can assign functions to the camera's custom menu using the dial and Fn button. You can use an AC adaptor (sold separately) via the HLD-7. Be sure to turn off the camera's power when attaching or removing the power battery holder.

■ Names of parts

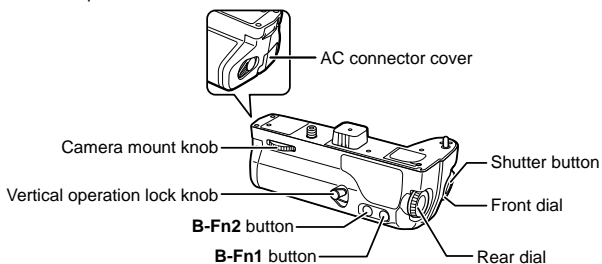

■ Attaching the HLD-7

Remove the PBH cover (a) on the bottom of the camera and attach the HLD-7. Once the HLD-7 is attached, turn the release wheel firmly. Be sure to put the PBH cover on the camera when the HLD-7 is not attached.

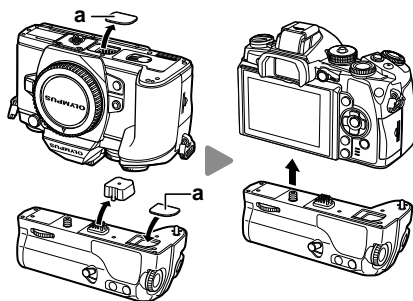

■ Inserting the battery

Use a BLN-1 battery. After inserting the battery, be sure to lock the battery cover.

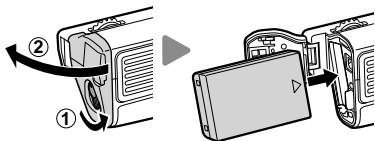

■ Using the AC adaptor

When using the AC adaptor, open the AC connector cover and plug in the AC connector.

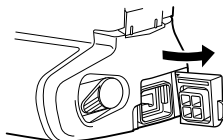

■ Using the dial and button

Set the functions for the HLD-7 dial and **B-Fn** button using [Button Function] on the camera's custom menu. "Button Function" (P. 99)

■ Main Specifications (HLD-7)

Power supply	Battery: Li-ion Battery BLN-1 x1 AC power supply: AC adapter AC-3
Dimensions	Approx. 128.5mm (W) x 48.2mm (H) x 57.3mm (D) (5.1" x 1.9" x 2.3")
Weight	Approx. 235g (0.5 lb.) (excluding the battery and connector cap)
Splash resistance (when attached to a camera)	Type Equivalent to IEC Standard publication 529 IPX1 (under OLYMPUS test conditions)

Cautions

- Do not use batteries or AC adaptors other than those specified. Doing so may cause an injury or may cause the device to fail or explode.
- Do not use your fingernails to turn the release knob. Doing so may cause an injury.
- Use the camera only within the guaranteed operation temperature range.
- Do not use or store this device in locations with a lot of dust or high humidity.
- Do not touch the contact points of this device.
- If the main body or contacts become dirty, wipe them with a soft, dry cloth. Do not use a damp cloth or organic solvents such as paint thinner or benzene.

External flash units designated for use with this camera

With this camera, you can use one of the separately sold external flash units to achieve a flash suited to your needs. The external flashes communicate with the camera, allowing you to control the camera's flash modes with various available flash control modes, such as TTL-AUTO and Super FP flash. An external flash unit specified for use with this camera can be mounted on the camera by attaching it to the camera's hot shoe. You can also attach the flash to the flash bracket on the camera using the bracket cable (optional). Refer to the documentation provided with the external flash units as well.

The upper limit of the shutter speed is 1/250 sec. when using a flash.

Functions available with external flash units

Optional flash	Flash control mode	GN (Guide number) (ISO100)	RC mode
FL-600R	TTL-AUTO, AUTO, MANUAL, FP TTL AUTO, FP MANUAL	GN36 (85 mm*) GN20 (24 mm*)	✓
FL-300R	TTL-AUTO, MANUAL	GN20 (28 mm*)	✓
FL-14	TTL-AUTO, AUTO, MANUAL	GN14 (28 mm*)	—
RF-11	TTL-AUTO, MANUAL	GN11	—
TF-22		GN22	—

* The focal length of the lens that can be used (Calculated based on 35 mm film camera).

Wireless remote control flash photography

External flash units that are designated for use with this camera and have a remote control mode can be used for wireless flash photography. The camera can separately control each of three groups of remote flash units, and the supplied external flash. See the instruction manuals provided with the external flash units for details.

- Set the remote flash units to RC mode and place them as desired.
 - Turn the external flash units on, press the MODE button, and select RC mode.
 - Select a channel and group for each external flash unit.
- Select [On] for [⚡ RC Mode] in  Shooting Menu 2 (P. 76).
 - The super control panel switches to RC mode.
 - You can choose the super control panel display by repeatedly pressing the INFO button.
 - Select a flash mode (note that red-eye reduction is not available in RC mode).
- Adjust the settings for each group in the super control panel.

Group

- Select the flash control mode and adjust the flash intensity separately for each group. For MANUAL, select the flash intensity.

Adjust settings for the camera flash unit.

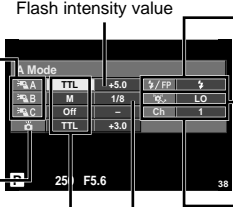

Flash intensity value

Normal flash/Super FP flash

- Switch between normal flash and Super FP flash.

Communication light level

- Set the communication light level to [HI], [MID], or [LO].

Channel

- Set the communication channel to the same channel used on the flash.

Flash control mode

Flash intensity mode

- Attach the supplied external flash to the camera and raise the flash head.
 - After confirming that the built-in and remote flash units have charged, take a test shot.

■ Wireless flash control range

Position the wireless flash units with their remote sensors facing the camera. The following illustration shows the approximate ranges at which the flash units can be positioned. The actual control range varies with local conditions.

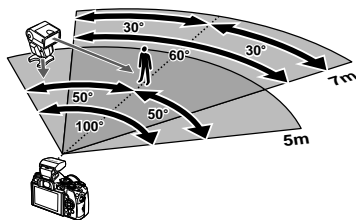

! Cautions

- We recommend using a single group of up to three remote flash units.
- Remote flash units cannot be used for second curtain slow synchronization or anti-shock exposures longer than 4 seconds.
- If the subject is too close to the camera, the control flashes emitted by the camera flash may affect exposure (this effect can be reduced by reducing the output of the camera flash by, for example, using a diffuser).
- The upper limit of flash synchronization timing is 1/250 sec. when using the flash in remote control mode.

Other external flash units

Use after connecting the synchro cord to the hot shoe or external flash jack. When not using an external flash terminal, be sure to attach the cap.

When attaching a third-party flash to the camera's hot shoe or external flash jack, be careful of the following points.



- Using obsolete flash units that apply currents of more than about 250 V to the X-contact will damage the camera.
- Connecting flash units with signal contacts that do not conform to Olympus specifications may damage the camera.
- Set the Shooting mode to **M**, set the shutter speed to a value no higher than flash synchronous speed, and set ISO sensitivity to a setting other than [AUTO].
- Flash control can only be performed by manually setting the flash to the ISO sensitivity and aperture values selected with the camera. Flash brightness can be adjusted by adjusting either ISO sensitivity or aperture.
- Use a flash with an angle of illumination suited to the lens. Angle of illumination is usually expressed using 35-mm format equivalent focal lengths.

Principal Accessories

Four Thirds lens adapter (MMF-2/MMF-3)

The camera requires a Four Thirds lens adapter to attach Four Thirds lenses. Since the AF method differs when using a Micro Four Thirds system lens, the AF operational area is narrower.

Remote cable (RM-UC1)

Use when the slightest camera movement can result in blurred pictures, for example for macro or bulb photography. The remote cable attaches via the camera multi-connector.

Converter lenses

Converter lenses attach to the camera lens for quick and easy fish-eye or macro photography. See the OLYMPUS website for information on the lenses that can be used.

- Use the appropriate lens attachment for SCN mode (📷, 📷, or 📷).

Macro arm light (MAL-1)

Use to illuminate subjects for macro photography, even at ranges at which vignetting would occur with the flash.

Microphone set (SEMA-1)

The microphone can be placed at a distance from the camera to avoid recording ambient sounds or wind noise. Third-party commercial microphones can also be used depending on your creative intent. We recommend that you use the supplied extension cord. (power supplied via ø3.5 mm stereo mini-plug)

Eyecup (EP-13)

You can exchange this for a larger eyecup.

Removing

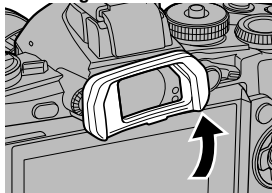

System chart

Power Supply



BLN-1
Li-ion Battery



BCN-1
Li-ion Battery Charger

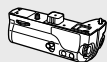

HLD-7
Power Battery Holder



AC-3
AC adapter

Viewfinder

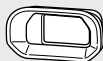

EP-13
Eyecup



VF-3/VF-4
Electronic View Finder

E-M1

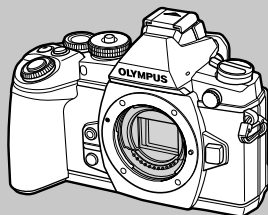

Remote Operation

RM-UC1
Remote Cable



Connection Cable

USB Cable/
AV Cable/
HDMI Cable

Case / Strap

Shoulder Strap
Camera Case

Underwater System

Underwater case

Memory Card*4

SD/SDHC/
SDXC/Eye-Fi

Software

OLYMPUS Viewer
Digital Photo Managing Software

Accessory port devices



OLYMPUS PENPAL PP-1³
Communication Unit

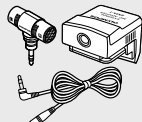

SEMA-1
Microphone Set 1

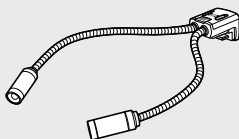

MAL-1
MACRO ARM LIGHT

*1 Not all lenses can be used with adapter. For details, refer to the Olympus Official Web Site. Also, please note that manufacture of OM System Lenses has been discontinued.

*2 For compatible lens, refer to the Olympus Official Web Site.

□ : E-M1 compatible products

■ : Commercially available products

For the latest information, please visit the Olympus website.

Lens



M.ZUIKO DIGITAL ED 12-50mm f3.5-6.3 EZ
M.ZUIKO DIGITAL ED 12-40mm f2.8 PRO
M.ZUIKO DIGITAL ED 12mm f2.0
M.ZUIKO DIGITAL 17mm f1.8
M.ZUIKO DIGITAL 17mm f2.8
M.ZUIKO DIGITAL 45mm f1.8
M.ZUIKO DIGITAL ED 75mm f1.8
M.ZUIKO DIGITAL ED 60mm f2.8 Macro
M.ZUIKO DIGITAL 14-42mm f3.5-5.6 II R
M.ZUIKO DIGITAL ED 9-18mm f4.0-5.6
M.ZUIKO DIGITAL ED 14-150mm f4.0-5.6
M.ZUIKO DIGITAL ED 40-150mm f4.0-5.6 R
M.ZUIKO DIGITAL 75-300mm f4.8-6.7 II



MMF-2/MMF-3*1
Four Thirds Adapter



Four Thirds System Lenses



MF-2*1
OM Adapter 2

OM System Lenses

Converter Lens*2



FCON-P01
Fisheye



WCON-P01
Wide



MCON-P01
Macro

Flash

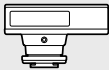

FL-14
Electronic Flash



FL-600R
Electronic Flash



FL-300R
Electronic Flash

SRF-11 Ring Flash Set



RF-11*2
Ring Flash



STF-22 Twin Flash Set



TF-22*2
Twin Flash

FC-1 Macro Flash Controller

12

Using separately sold accessories

*3 The OLYMPUS PENPAL can be used only in the region in which it was purchased. Depending on the areas, the usage may infringe the wave regulations and may be subject to its penalty.

*4 Use the Eye-Fi card in compliance with the laws and regulations of the country where the camera is used.

Shooting tips and information

The camera does not turn on even when a battery is loaded

The battery is not fully charged

- Charge the battery with the charger.

The battery is temporarily unable to function because of the cold

- Battery performance drops at low temperatures. Remove the battery and warm it by putting it in your pocket for a while.

No picture is taken when the shutter button is pressed

The camera has turned off automatically

- The camera automatically enters sleep mode to reduce the drain on the battery if no operations are performed for a set period of time.  [Sleep] (P. 93)
If no operations are performed for a set time (4 hours) after the camera has entered sleep mode, the camera will turn off automatically.

The flash is charging

- On the monitor, the  mark blinks when charging is in progress. Wait for the blinking to stop, then press the shutter button.

Unable to focus

- The camera cannot focus on subjects that are too close to the camera or that are not suited to autofocus (the AF confirmation mark will blink in the monitor). Increase the distance to the subject or focus on a high contrast object at the same distance from the camera as your main subject, compose the shot, and shoot.

Subjects that are difficult to focus on

It may be difficult to focus with auto focus in the following situations.

AF confirmation mark is blinking. These subjects are not focused.

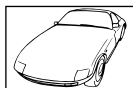

Subject with low contrast

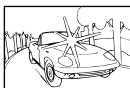

Excessively bright light in center of frame

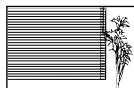

Subject containing no vertical lines

AF confirmation mark lights up but the subject is not focused.



Subjects at different distances

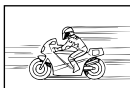

Fast-moving subject



Subject not inside AF area

Noise reduction is activated

- When shooting night scenes, shutter speeds are slower and noise tends to appear in images. The camera activates the noise-reduction process after shooting at slow shutter speeds. During which, shooting is not allowed. You can set [Noise Reduct.] to [Off].
 [Noise Reduct.] (P. 93)

The number of AF targets is reduced

The number and size of AF targets varies with aspect ratio, group target settings, and the option selected for [Digital Tele-converter]. When using a Four Thirds system lens, there are 37 targets.

The date and time has not been set

The camera is used with the settings at the time of purchase

- The date and time of the camera is not set when purchased. Set the date and time before using the camera.  "Setting the date/time" (P. 17)

The battery has been removed from the camera

- The date and time settings will be returned to the factory default settings if the camera is left without the battery for approximately 1 day. The settings will be cancelled more quickly if the battery was only loaded in the camera for a short time before being removed. Before taking important pictures, check that the date and time settings are correct.

Set functions are restored to their factory default settings

When you rotate the mode dial or turn off the power in a shooting mode other than **P**, **A**, **S**, or **M**, functions with changes made to their settings are restored to the factory default settings.

Image taken appears whitish

This may occur when the picture is taken in backlight or semi-backlight conditions. This is due to a phenomenon called flare or ghosting. As far as possible, consider a composition where strong light source is not taken in the picture. Flare may occur even when a light source is not present in the picture. Use a lens hood to shade the lens from the light source. If a lens hood does not have effect, use your hand to shade the lens from the light.

 "Interchangeable lenses" (P. 125)

Unknown bright dot(s) appear on the subject in the picture taken

This may be due to stuck pixel(s) on the image pickup device. Perform [Pixel Mapping].









If the problem persists, repeat pixel mapping a few times.  "Pixel Mapping - Checking the image processing functions" (P. 141)









Functions that cannot be selected from menus

Some items may not be selectable from the menus when using the arrow pad.

- Items that cannot be set with the current shooting mode.
- Items that cannot be set because of an item that has already been set:
Combination of  and [Noise Reduct.], etc.

Error codes

Monitor indication	Possible cause	Corrective action
 No Card	The card is not inserted, or it cannot be recognized.	Insert a card or insert a different card.
 Card Error	There is a problem with the card.	Insert the card again. If the problem persists, format the card. If the card cannot be formatted, it cannot be used.
 Write Protect	Writing to the card is prohibited.	The card write-protect switch is set to the "LOCK" side. Release the switch. (P. 123)
 Card Full	<ul style="list-style-type: none"> The card is full. No more pictures can be taken or no more information such as print reservation can be recorded. There is no space in the card and print reservation or new images cannot be recorded. 	Replace the card or erase unwanted pictures. Before erasing, download important images to a PC.
	Card cannot be read. Card may not have been formatted.	<ul style="list-style-type: none"> Select [Clean Card], press \odot and turn off the camera. Remove the card and wipe dry the metallic surface with a soft, dry cloth. Select [Format] \blacktriangleright [Yes], and then press \odot to format the card. Formatting the card erases all data on the card.
 No Picture	There are no pictures on the card.	The card contains no pictures. Record pictures and play back.
 Picture Error	The selected picture cannot be displayed for playback due to a problem with this picture. Or the picture cannot be used for playback on this camera.	Use image processing software to view the picture on a PC. If that cannot be done, the image file is damaged.
 The Image Cannot Be Edited	Pictures taken with another camera cannot be edited on this camera.	Use image processing software to edit the picture.
 Picture Error	Images cannot be transferred between devices that are currently receiving or transmitting data.	Increase the amount of memory available on the card, for example by deleting unwanted images, or choose a smaller size for the images being transmitted.

Monitor indication	Possible cause	Corrective action
		Turn off the camera and wait for the internal temperature to cool.
 Internal camera temperature is too high. Please wait for cooling before camera use.	The internal temperature of the camera has risen due to sequential shooting.	Wait a moment for the camera to turn off automatically. Allow the internal temperature of the camera to cool before resuming operations.
 Battery Empty	The battery is drained.	Charge the battery.
 No Connection	The camera is not correctly connected to a computer, printer, HDMI display, or other device.	Reconnect the camera.
 No Paper	There is no paper in the printer.	Load some paper in the printer.
 No Ink	The printer has run out of ink.	Replace the ink cartridge in the printer.
 Jammed	The paper is jammed.	Remove the jammed paper.
Settings Changed	The printer's paper cassette has been removed or the printer has been manipulated while making settings on the camera.	Do not manipulate the printer while making settings on the camera.
 Print Error	There is a problem with the printer and/or camera.	Turn off camera and printer. Check the printer and remedy any problems before turning the power on again.
 Cannot Print	Pictures recorded on other cameras may not be printed on this camera.	Use a personal computer to print.
The lens is locked. Please extend the lens.	The lens of the retractable lens stays retracted.	Extend the lens. (P. 14)
Please check the status of a lens.	An abnormality has occurred between the camera and the lens.	Turn off the camera, check the connection with the lens, and turn the power on again.

Cleaning and storing the camera

Cleaning the camera

Turn off the camera and remove the battery before cleaning the camera.

Exterior:

- Wipe gently with a soft cloth. If the camera is very dirty, soak the cloth in mild soapy water and wring well. Wipe the camera with the damp cloth and then dry it with a dry cloth. If you have used the camera at the beach, use a cloth soaked in clean water and well wrung.

Monitor:

- Wipe gently with a soft cloth.

Lens:

- Blow dust off the lens with a commercially available blower. For the lens, wipe gently with a lens cleaning paper.

Storage

- When not using the camera for a prolonged period, remove the battery and card. Store the camera in a cool, dry place that is well ventilated.
- Insert the battery periodically and test the camera's functions.
- Remove dust and other foreign matter from the body and rear caps before attaching them.
- Attach the body cap to the camera to prevent dust from getting inside when no lens is attached. Be sure to replace the front and rear lens caps before putting the lens away.
- Clean the camera after use.
- Do not store with insect repellent.

Cleaning and checking the image pickup device

This camera incorporates a dust reduction function to keep dust from getting on the image pickup device and to remove any dust or dirt from the image pickup device surface with ultrasonic vibrations. The dust reduction function operates when the camera is turned on.

The dust reduction function operates at the same time as the pixel mapping, which checks the image pickup device and image processing circuitry. Since dust reduction is activated every time the camera's power is turned on, the camera should be held upright for the dust reduction function to be effective.



ⓘ Cautions

- Do not use strong solvents such as benzene or alcohol, or a chemically treated cloth.
- Avoid storing the camera in places where chemicals are treated, in order to protect the camera from corrosion.
- Mold may form on the lens surface if the lens is left dirty.
- Check each part of the camera before use if it has not been used for a long time. Before taking important pictures, be sure to take a test shot and check that the camera works properly.

Pixel Mapping - Checking the image processing functions

The pixel mapping feature allows the camera to check and adjust the image pickup device and image processing functions. After using the monitor or taking continuous shots, wait for at least one minute before using the pixel mapping function to ensure that it operates correctly.

1 Select [Pixel Mapping] in  Custom Menu (P. 98) tab .

2 Press , then press .

- The [Busy] bar is displayed when pixel mapping is in progress. When pixel mapping is finished, the menu is restored.

Cautions

- If you accidentally turn the camera off during pixel mapping, start again from Step 1.









Menu directory

*1: Can be added to [Myset].

*2: Default can be restored by selecting [Full] for [Reset].

*3: Default can be restored by selecting [Basic] for [Reset].

Shooting Menu

Tab	Function	Default	*1	*2	*3			
	Card Setup	—				76		
	Reset/Myset	—		✓		77		
	Picture Mode	 Natural	✓	✓	✓	68		
		Still Picture	 N	✓	✓	✓	70	
		Movie	MOV FullHD 					
		Image Aspect	4:3	✓	✓	✓	69	
		Digital Tele-converter	Off	✓	✓	✓	84	
			✓	✓	✓	55		
	Image Stabilizer	Still Picture	S-I.S. Auto	✓	✓	✓	66	
		Movie	M-I.S. On	✓	✓	✓		
	Bracketing		Off	✓	✓	✓	80	
		AE BKT	3f 1.0EV					
		WB BKT	A-B					—
			G-M					
		FL BKT	—					81
		ISO BKT	—					81
	ART BKT	—	81					
	HDR	Off	✓	✓	✓	59		
	Multiple Exposure	Frame	Off	✓	✓	✓	82	
		Auto Gain	Off					
		Overlay	Off					
	Time Lapse Settings		Off	✓	✓	✓	83	
Frame		99						
Start Waiting Time		00:00:01						
Interval Time		00:00:01						
Time Lapse Movie		Off						
 RC Mode	Off	✓	✓	✓	131			

▶ Playback Menu

Tab	Function		Default	*1	*2	*3		
▶		Start	—				65	
		BGM	Joy		✓	✓		
		Slide	All		✓	✓		
		Slide Interval	3 sec		✓			
		Movie Interval	Short		✓			
			On		✓	✓	85	
	Edit	Sel. Image	RAW Data Edit	—				85
			JPEG Edit	—				86
				—				87
		Image Overlay	—				87	
	Print Order	—				112		
	Reset Protect	—				87		
	Connection to Smartphone	—				87		

ƒ Setup Menu

Tab	Function		Default	*1	*2	*3	
ƒ			—				17
		*	—				88
			±0, ±0, Natural		✓		88
	Rec View		0.5 sec		✓	✓	88
	Wi-Fi Settings	Wi-Fi Connect Settings	Private			✓	88
		Private Password	—				
		Reset share Order	—				
		Reset Wi-Fi Settings	—				
	/ Menu Display	Menu Display	On			✓	88
		Menu Display	Off				
	Firmware	—				88	

* Settings differ depending on the region where the camera is purchased.

⚙️ Custom Menu

Tab	Function	Default	*1	*2	*3	👉		
🔍	AF/MF							
	AF Mode	Still Picture	S-AF	✓	✓	✓	90	
		Movie	C-AF					
	Full-time AF		Off	✓	✓	✓		
	AEL/AFL		S-AF	✓	✓	✓		
			C-AF					mode1
			MF					mode1
	Reset Lens		On		✓	✓		
	BULB/TIME Focusing		On		✓	✓		
	Focus Ring		🕒	✓	✓	✓		
	MF Assist	Magnify	Off	✓	✓			
		Peaking	Off	✓	✓			
	[⏪] Set Home		📄		✓	✓		
	AF Illuminat.		On	✓	✓	✓		
	☉ Face Priority		👤	✓	✓	✓		
AF Area Pointer		On	✓	✓	✓			
C-AF Lock		Off		✓	✓			
91								
🔧	Button/Dial/Lever							
	Button Function	[Fn1] Function	[⋮]	✓	✓		91	
		[Fn2] Function	Multi Function					
		📷 Function	📷/REC					
		AEL Function	AEL/AFL					
		📷 Function	📷					
		🔧 Function	🔧					
		▶ Function	⚡*					
		▽ Function	📄/🌙*					
		📄 Function	[⋮]					
		[Bfn1] Function	AEL/AFL					
		[Bfn2] Function	[⋮]					
	[Lfn] Function	AF Stop						
	Dial Function	P	Ps/📷	✓	✓			
		A	FNo./📷					
		S	Shutter/📷					
		M	Shutter/FNo.					
		Menu	△ ▽ / ◀ ▶					
		▶	Prev/Next/📷/Q					
	Dial Direction		Exposure	Dial1	✓	✓		
			Ps	Dial1				
Mode Dial Function		Off		✓				
📷 Lever Function		mode1		✓				
📷+🔍		On		✓				

* When [📄 Function] is set to [Direct Function]

Tab	Function	Default	*1	*2	*3	
	Release/					
	RIs Priority S	Off	✓	✓	✓	91
	RIs Priority C	On	✓	✓	✓	
	L fps	6 fps	✓	✓	✓	
	H fps	10 fps	✓	✓	✓	
	+ IS Off	On		✓		
	Half Way RIs With IS	On		✓		
	Lens I.S. Priority	Off	✓		✓	92
	Release Lag-Time	Normal		✓		
	Disp/					
HDMI	HDMI Out	1080i		✓		92
	HDMI Control	Off		✓		
Video Out		—				
Control Settings	iAUTO	Live Guide		✓		
	P/A/S/M	Live Control		✓		
	ART	Art Menu		✓		
	SCN	Scene Menu		✓		
Info Settings	Info	Image Only, Overall	✓	✓	✓	
	LV-Info	Image Only, , Level Gauge	✓	✓		
	Settings	25, Calendar	✓	✓		
Displayed Grid	Off		✓	✓		
Picture Mode Settings	All On		✓	✓		
Histogram Settings	Highlight	255				
	Shadow	0		✓		
Mode Guide	On			✓		
Live View Boost	Off		✓	✓	✓	
Frame Rate	Normal		✓	✓	✓	
Art LV Mode	mode1			✓		
Expand LV Dyn. Range	On			✓		
Flicker reduction	Auto			✓		
LV Close Up Mode	mode2			✓		
Peaking Settings	White		✓	✓		
Backlit LCD	Hold		✓	✓	✓	
Sleep	1 min		✓	✓	✓	
Auto Power Off	4h			✓	✓	
	On		✓	✓	✓	
USB Mode	Auto			✓	✓	
						93

Tab	Function	Default	*1	*2	*3	
	Exp//ISO					
	EV Step	1/3EV	✓	✓	✓	93
	Noise Reduct.	Auto	✓	✓	✓	
	Noise Filter	Standard	✓	✓	✓	
	ISO	Auto	✓	✓	✓	94
	ISO Step	1/3EV	✓	✓	✓	
	ISO-Auto Set	High Limit: 1600 Default: 200	✓	✓	✓	
	ISO-Auto	P/A/S	✓	✓		
	Metering		✓	✓	✓	
	AEL Metering	Auto	✓	✓	✓	
	BULB/TIME Timer	8 min	✓	✓	✓	
	BULB/TIME Monitor	-7	✓	✓		
	Live BULB	Off	✓	✓		
	Live TIME	0.5 sec	✓	✓		
Anti-Shock	Off	✓	✓	✓		
Custom						
X-Sync.	1/320	✓	✓	✓	94	
Slow Limit	1/60	✓	✓	✓		
+	Off	✓	✓	✓		
/Color/WB						
Set	-1 F, -2 N, -3 N, -4 N	✓	✓	✓	95	
Pixel	Middle 2560x1920	✓	✓	✓		
Count	Small 1280x960					
Shading Comp.	Off	✓	✓	✓		
WB	Auto A:0, G:0	✓	✓	✓		
All	All Set —	✓	✓			
	All Reset —		✓			
Keep Warm Color	On	✓	✓	✓		
+WB	WB Auto	✓	✓	✓		
Color Space	sRGB	✓	✓	✓		
Record/Erase						
Quick Erase	Off	✓	✓	✓	96	
RAW+JPEG Erase	RAW+JPEG	✓	✓	✓		
File Name	Reset		✓			
Edit Filename	Off		✓			
Priority Set	No		✓	✓		
dpi Settings	350dpi		✓			
Copyright Settings	Copyright Info.	Off		✓		
	Artist Name	—				
	Copyright Name	—				

Tab	Function	Default	*1	*2	*3			
	Movie							
		Mode	P		✓		97	
		Movie	On	✓	✓	✓		
		Movie Effect	On		✓			
		Wind Noise Reduction	Off		✓			
		Recording Volume	Built-In Standard External Standard Line-In Standard		✓			
	Built-In EVF							
		Built-in EVF Style	Style 3		✓		97	
		Info Settings	Level Gauge, Basic Information		✓			
		Displayed Grid	Off	✓	✓	✓		
		EVF Auto Switch	On		✓			
		EVF Adjust	EVF Auto Luminance	On	✓	✓		✓
		Half Way Level	On		✓			
	Utility							
		Pixel Mapping	—				98	
	Exposure Shift		±0	✓	✓			
	AF Focus Adj.	Off						
	Warning Level	±0			✓			
	Battery Priority	PBH Battery	✓	✓				
	Level Adjust	—			✓			
	Touch Screen Settings	On			✓			
	Eye-Fi	On			✓			

Accessory Port Menu

Tab	Function	Default	*1	*2	*3			
	OLYMPUS PENPAL Share							
		Please Wait	—				109, 110	
		Address Book	Address List	—				110
			Search Timer	30sec		✓		
			New Pairing	—				
		My OLYMPUS PENPAL	—					
		Picture Send Size	Size 1: Small		✓			
	OLYMPUS PENPAL Album							
		Copy All	—				111	
		Reset Protect	—					
		Album Mem. Usage	—					
		Album Mem. Setup	—					
		Picture Copy Size	Size 2: Medium		✓			
	Electronic Viewfinder							
		EVF Adjust	±0, ±0		✓		111	
	EVF Auto Switch	On		✓				

Specifications

■ Camera

Product type	
Product type	Digital camera with interchangeable Micro Four Thirds Standard lens system
Lens	M.Zuiko Digital, Micro Four Thirds System Lens
Lens mount	Micro Four Thirds mount
Equivalent focal length on a 35 mm film camera	Approx. twice the focal length of the lens
Image pickup device	
Product type	4/3" Live MOS sensor
No. of total pixels	Approx. 17,200,000 pixels
No. of effective pixels	Approx. 16,280,000 pixels
Screen size	17.3 mm (H) × 13.0 mm (V)
Aspect ratio	1.33 (4:3)
Viewfinder	
Type	Electronic viewfinder with eye sensor
No. of pixels	2,360,000 pixels
Magnification	100%
Eye point	Approx. 21.0 mm (−1 m ⁻¹)
Live view	
Sensor	Uses Live MOS sensor
Field of view	100%
Monitor	
Product type	3.0" TFT color LCD, Vari-angle, touch screen
Total no. of pixels	Approx. 1,040,000 dots (aspect ratio 3:2)
Shutter	
Product type	Computerized focal-plane shutter
Shutter	1/8000 - 60 sec., bulb photography, time photography
Auto focus	
Product type	Hi-Speed Imager AF
Focusing points	81 points
Selection of focusing point	Auto, Optional
Exposure control	
Metering system	TTL metering system (imager metering) Digital ESP metering/Center weighted averaging metering/Spot metering
Metered range	EV -2 - 20 (Equivalent to M.ZUIKO DIGITAL 17mm f2.8, ISO100)
Shooting modes	i AUTO: iAUTO/ P : Program AE (Program shift can be performed)/ A : Aperture priority AE/ S : Shutter priority AE/ M : Manual/ ■ : PHOTO STORY/ART: Art filter/SCN: Scene/ S : Movie
ISO sensitivity	LOW, 200 - 25600 (1/3, 1 EV step)
Exposure compensation	±5EV (1/3, 1/2, 1 EV step)
White balance	
Product type	Image pickup device
Mode setting	Auto/Preset WB (7 settings)/Customized WB/One-touch WB

Recording	
Memory	SD, SDHC, SDXC and Eye-Fi UHS-I compatible
Recording system	Digital recording, JPEG (in accordance with Design rule for Camera File system (DCF)), RAW Data, MP format
Applicable standards	Exif 2.3, Digital Print Order Format (DPOF), PRINT Image Matching III, PictBridge
Sound with still pictures	Wave format
Movie	MPEG-4 AVC/H.264 / Motion JPEG
Audio	Stereo, PCM 48kHz
Playback	
Display format	Single-frame playback/Close-up playback/Index display/Calendar display
Drive	
Drive mode	Single-frame shooting/Sequential shooting/Self-timer
Sequential shooting	Up to 10 fps ()
Self-timer	Operation time: 12 sec./2 sec./Customized
Energy saving function	Switch to sleep mode: 1 minute, Power OFF: 4 hours (This function can be customized.)
External flash	
Flash control mode	TTL-AUTO (TTL pre-flash mode)/MANUAL
Sync speed	1/320 s or slower (FL-LM2)
Wireless LAN	
Compatible standard	IEEE 802.11b/g/n
External connector	
Multi-connector (USB connector, AV connector)/HDMI micro-connector (type D)/ Accessory port/ External flash connector/Microphone connector	
Power supply	
Battery	Li-ion Battery x1
Dimensions/weight	
Dimensions	130.4 mm (W) x 93.5 mm (H) x 63.1 mm (D) (5.1" x 3.7" x 2.5") (excluding protrusions)
Weight	Approx. 497 g (0.9 lb.) (including battery and memory card)
Operating environment	
Temperature	-10 °C - 40 °C (14 °F - 104 °F) (operation)/-20 °C - 60 °C (-4 °F - 140 °F) (storage)
Humidity	30% - 90% (operation)/10% - 90% (storage)
Splash resistance	
Type	Equivalent to IEC Standard publication 529 IPX1 (under OLYMPUS test conditions)

HDMI, the HDMI logo and High-Definition Multimedia Interface are trademarks or registered trademarks of HDMI Licensing LLC.

HDMI™
HIGH-DEFINITION MULTIMEDIA INTERFACE

13

Information

■ FL-LM2

Guide number	7 (ISO100), 10 (ISO200)
Firing angle	Covers the angle of view of a 14 mm lens (28 mm in 35 mm format)
Dimensions	Approx. 44.3 mm (W) × 33.5 mm (H) × 52.5 mm (D) (1.7" × 1.3" × 2.1")
Weight	Approx. 31 g (0.07 lb.)
Splash resistance	Type Equivalent to IEC Standard publication 529 IPX1 (under OLYMPUS test conditions)

■ Lithium ion battery

MODEL NO.	BLN-1
Product type	Rechargeable Lithium ion battery
Nominal voltage	DC 7.6 V
Nominal capacity	1220 mAh
No. of charge and discharge times	Approx. 500 times (varies with usage conditions)
Ambient temperature	0 °C - 40 °C (32 °F - 104 °F) (charging)
Dimensions	Approx. 36.0 mm (W) × 15.4 mm (H) × 50.2 mm (D) (1.4" × 0.6" × 2.0")
Weight	Approx. 52 g (0.1 lb.)

■ Lithium ion charger

MODEL NO.	BCN-1
Rated input	AC 100V - 240V (50/60Hz)
Rated output	DC 8.7V, 600mA
Charging time	Approx. 4 hours (room temperature)
Ambient temperature	0 °C - 40 °C (32 °F - 104 °F) (operation)/ -20 °C - 60 °C (-4 °F - 140 °F) (storage)
Dimensions	Approx. 67 mm (W) × 26 mm (H) × 95.5 mm (D) (2.6" × 1.0" × 3.8")
Weight (without AC cable)	Approx. 77 g (0.2 lb.)

- The AC cable supplied with this device is for use only with this device and should not be used with other devices. Do not use cables for other devices with this device.

SPECIFICATIONS ARE SUBJECT TO CHANGE WITHOUT ANY NOTICE OR OBLIGATION ON THE PART OF THE MANUFACTURER.

SAFETY PRECAUTIONS

**CAUTION**

**RISK OF ELECTRIC SHOCK
DO NOT OPEN**



CAUTION: TO REDUCE THE RISK OF ELECTRICAL SHOCK, DO NOT REMOVE COVER (OR BACK). NO USER-SERVICEABLE PARTS INSIDE. REFER SERVICING TO QUALIFIED OLYMPUS SERVICE PERSONNEL.



An exclamation mark enclosed in a triangle alerts you to important operating and maintenance instructions in the documentation provided with the product.

**DANGER**

If the product is used without observing the information given under this symbol, serious injury or death may result.

**WARNING**

If the product is used without observing the information given under this symbol, injury or death may result.

**CAUTION**

If the product is used without observing the information given under this symbol, minor personal injury, damage to the equipment, or loss of valuable data may result.

WARNING!

TO AVOID THE RISK OF FIRE OR ELECTRICAL SHOCK, NEVER DISASSEMBLE, EXPOSE THIS PRODUCT TO WATER OR OPERATE IN A HIGH HUMIDITY ENVIRONMENT.

General Precautions

Read All Instructions — Before you use the product, read all operating instructions. Save all manuals and documentation for future reference.

Cleaning — Always unplug this product from the wall outlet before cleaning. Use only a damp cloth for cleaning. Never use any type of liquid or aerosol cleaner, or any type of organic solvent to clean this product.

Attachments — For your safety, and to avoid damaging the product, use only accessories recommended by Olympus.

Water and Moisture — For precautions on products with weatherproof designs, read the weatherproofing sections.

Location — To avoid damage to the product, mount the product securely on a stable tripod, stand, or bracket.

Power Source — Connect this product only to the power source described on the product label.

Foreign Objects — To avoid personal injury, never insert a metal object into the product.

Heat — Never use or store this product near any heat source such as a radiator, heat register, stove, or any type of equipment or appliance that generates heat, including stereo amplifiers.

Product Handling Precautions

WARNING

- **Do not use the camera near flammable or explosive gases.**
- **Do not use the flash and LED on people (infants, small children, etc.) at close range.**

You must be at least 1 m (3 ft.) away from the faces of your subjects. Firing the flash too close to the subject's eyes could cause a momentary loss of vision.

- **Keep young children, infants, and animals such as pets away from the camera.**

Always use and store the camera out of the reach of young children and infants to prevent the following dangerous situations which could cause serious injury:

- Becoming entangled in the camera strap, causing strangulation.
- Accidentally swallowing the battery, cards or other small parts.
- Accidentally firing the flash into their own eyes or those of another child.
- Accidentally being injured by the moving parts of the camera.
- **Do not look at the sun or strong lights with the camera.**
- **Do not use or store the camera in dusty or humid places.**
- **Do not cover the flash with a hand while firing.**

CAUTION

- **Stop using the camera immediately if you notice any unusual odors, noise, or smoke around it.**
Never remove the batteries with bare hands, which may cause a fire or burn your hands.
- **Never hold or operate the camera with wet hands.**
- **Do not leave the camera in places where it may be subject to extremely high temperatures.**
Doing so may cause parts to deteriorate and, in some circumstances, cause the camera to catch fire.
Do not use the charger if it is covered (such as a blanket). This could cause overheating, resulting in fire.
- **Handle the camera with care to avoid getting a low-temperature burn.**

When the camera contains metal parts, overheating can result in a low-temperature burn. Pay attention to the following:

- When used for a long period, the camera will get hot. If you hold on to the camera in this state, a low temperature burn may be caused.
- In places subject to extremely cold temperatures, the temperature of the camera's body may be lower than the environmental temperature. If possible, wear gloves when handling the camera in cold temperatures.
- **Be careful with the strap.**

Be careful with the strap when you carry the camera. It could easily catch on stray objects - and cause serious damage.

Battery Handling Precautions

Follow these important guidelines to prevent batteries from leaking, overheating, burning, exploding, or causing electrical shocks or burns.

DANGER

- The camera uses a lithium ion battery specified by Olympus. Charge the battery with the specified charger. Do not use any other chargers.
- Never heat or incinerate batteries.
- Take precautions when carrying or storing batteries to prevent them from coming into contact with any metal objects such as jewelry, pins, fasteners, etc.
- Never store batteries where they will be exposed to direct sunlight, or subjected to high temperatures in a hot vehicle, near a heat source, etc.
- To prevent causing battery leaks or damaging their terminals, carefully follow all instructions regarding the use of batteries. Never attempt to disassemble a battery or modify it in any way, by soldering, etc.
- If battery fluid gets into your eyes, flush your eyes immediately with clear, cold running water and seek medical attention immediately.
- Always store batteries out of the reach of small children. If a child accidentally swallows a battery, seek medical attention immediately.
- Should you notice that the charger is emitting smoke, heat, or an unusual noise or smell, immediately cease use and unplug the charger from the power outlet, and then contact an authorized distributor or service center.

WARNING

- Keep batteries dry at all times.
- To prevent batteries from leaking, overheating, or causing a fire or explosion, use only batteries recommended for use with this product.
- Insert the battery carefully as described in the operating instructions.
- If rechargeable batteries have not been recharged within the specified time, stop charging them and do not use them.
- Do not use a battery if it is cracked or broken.
- If a battery leaks, becomes discolored or deformed, or becomes abnormal in any other way during operation, stop using the camera.
- If a battery leaks fluid onto your clothing or skin, remove the clothing and flush the affected area with clean, running cold water immediately. If the fluid burns your skin, seek medical attention immediately.
- Never subject batteries to strong shocks or continuous vibration.

⚠ CAUTION

- Before loading, always inspect the battery carefully for leaks, discoloration, warping, or any other abnormality.
- The battery may become hot during prolonged use. To avoid minor burns, do not remove it immediately after using the camera.
- Always unload the battery from the camera before storing the camera for a long period.
- This camera uses a lithium ion battery specified by Olympus. Do not use any other type of battery. For safe and proper use, read the battery's instruction manual carefully before using it.
- If the battery's terminals get wet or greasy, camera contact failure may result. Wipe the battery well with a dry cloth before use.
- Always charge a battery when using it for the first time, or if it has not been used for a long period.
- When operating the camera with battery power at low temperatures, try to keep the camera and spare battery as warm as possible. A battery that has run down at low temperatures may be restored after it is warmed at room temperature.
- The number of pictures you can take may vary depending on the shooting conditions or battery.
- Before going on a long trip, and especially before traveling abroad, purchase extra batteries. A recommended battery may be difficult to obtain while traveling.
- When the camera will not be used for an extended period, store it in a cool place.
- Please recycle batteries to help save our planet's resources. When you throw away dead batteries, be sure to cover their terminals and always observe local laws and regulations.

Precautions when using the wireless LAN function

⚠ WARNING

- **Turn off the camera in hospitals and other locations where medical equipment is present.**
The radio waves from the camera may adversely affect medical equipment, causing a malfunction that results in an accident.
- **Turn off the camera when onboard aircraft.**
Using wireless devices onboard may hinder safe operation of the aircraft.

Caution for Usage Environment

- To protect the high-precision technology contained in this product, never leave the camera in the places listed below, no matter if in use or storage:
 - Places where temperatures and/or humidity are high or go through extreme changes. Direct sunlight, beaches, locked cars, or near other heat sources (stove, radiator, etc.) or humidifiers.
 - In sandy or dusty environments.
 - Near flammable items or explosives.
 - In wet places, such as bathrooms or in the rain. When using products with weatherproof designs, read their manuals as well.
 - In places prone to strong vibrations.
- Never drop the camera or subject it to severe shocks or vibrations.
- When mounted on a tripod, adjust the position of the camera with the tripod head. Do not twist the camera.
- Do not leave the camera pointed directly at the sun. This may cause lens or shutter curtain damage, color failure, ghosting on the image pickup device, or may possibly cause fires.
- Do not touch electric contacts on cameras and interchangeable lenses. Remember to attach the body cap when removing the lens.
- Before storing the camera for a long period, remove the battery. Select a cool, dry location for storage to prevent condensation or mold from forming inside the camera. After storage, test the camera by turning it on and pressing the shutter release button to make sure that it is operating normally.
- The camera may malfunction if it is used in a location where it is subject to a magnetic/electromagnetic field, radio waves, or high voltage, such as near a TV set, microwave, video game, loud speakers, large monitor unit, TV/radio tower, or transmission towers. In such cases, turn the camera off and on again before further operation.
- Always observe the operating environment restrictions described in the camera's manual.
- Do not directly touch or wipe the image pickup device of the camera.

Monitor

The display on the rear of the camera is an LCD monitor.

- In the unlikely event that the monitor breaks, do not put the liquid crystal in your mouth. Any of the material adhering to your hands, feet, or clothing should be rinsed off immediately.
- A strip of light may appear on the top/bottom of the monitor, but this is not a malfunction.
- When a subject is viewed diagonally in the camera, the edges may appear zigzagged on the monitor. This is not a malfunction; it will be less noticeable in playback mode.
- In places subject to low temperatures, the monitor may take a long time to turn on or its color may change temporarily. When using the camera in extremely cold places, it is a good idea to occasionally place it in a warm place. A monitor exhibiting poor performance due to low temperatures will recover in normal temperatures.
- The monitor is made with high-precision technology. However, black spots or bright spots of light may appear constantly on the monitor. Due to its characteristics or the angle at which you are viewing the monitor, the spot may not be uniform in color and brightness. This is not a malfunction.

Lens

- Do not immerse in water or splash with water.
- Do not drop or exert strong force on the lens.
- Do not hold at the moving part of the lens.
- Do not touch the lens surface directly.
- Do not touch the contact points directly.
- Do not subject to abrupt temperature changes.

Legal and Other Notices

- Olympus makes no representations or warranties regarding any damages, or benefit expected by using this unit lawfully, or any request from a third person, which are caused by the inappropriate use of this product.
- Olympus makes no representations or warranties regarding any damages or any benefit expected by using this unit lawfully which are caused by erasing picture data.

Disclaimer of Warranty

- Olympus makes no representations or warranties, either expressed or implied, by or concerning any content of these written materials or software, and in no event shall be liable for any implied warranty of merchantability or fitness for any particular purpose or for any consequential, incidental or indirect damages (including but not limited to damages for loss of business profits, business interruption and loss of business information) arising from the use or inability to use these written materials or software or equipment. Some countries do not allow the exclusion or limitation of liability for consequential or incidental damages, so the above limitations may not apply to you.
- Olympus reserves all rights to this manual.

Warning

Unauthorized photographing or use of copyrighted material may violate applicable copyright laws. Olympus assumes no responsibility for unauthorized photographing, use or other acts that infringe upon the rights of copyright owners.

Copyright Notice

All rights reserved. No part of these written materials or this software may be reproduced or used in any form or by any means, electronic or mechanical, including photocopying and recording or the use of any type of information storage and retrieval system, without the prior written permission of Olympus. No liability is assumed with respect to the use of the information contained in these written materials or software, or for damages resulting from the use of the information contained therein. Olympus reserves the right to alter the features and contents of this publication or software without obligation or advance notice.

FCC Notice

This equipment has been tested and found to comply with the limits for a Class B digital device, pursuant to part 15 of the FCC Rules. These limits are designed to provide reasonable protection against harmful interference in a residential installation. This equipment generates, uses and can radiate radio frequency energy and, if not installed and used in accordance with the instructions, may cause harmful interference to radio communications. However, there is no guarantee that interference will not occur in a particular installation. If this equipment does cause harmful interference to radio or television reception, which can be determined by turning the equipment off and on, the user is encouraged to try to correct the interference by one or more of the following measures:

- Reorient or relocate the receiving antenna.
- Increase the separation between the equipment and receiver.
- Connect the equipment into an outlet on a circuit different from that to which the receiver is connected.
- Consult the dealer or an experienced radio/TV technician for help.
- Only the OLYMPUS-supplied USB cable should be used to connect the camera to USB enabled personal computers.

FCC Caution

Changes or modifications not expressly approved by the party responsible for compliance could void the user's authority to operate the equipment.

This transmitter must not be co-located or operated in conjunction with any other antenna or transmitter.

This equipment complies with FCC/IC radiation exposure limits set forth for an uncontrolled environment and meets the FCC radio frequency (RF) Exposure Guidelines in Supplement C to OET65 and RSS-102 of the IC radio frequency (RF) Exposure rules. This equipment has very low levels of RF energy that are deemed to comply without testing of specific absorption ratio (SAR).

Use Only Dedicated Rechargeable Battery and Battery Charger

We strongly recommend that you use only the genuine Olympus dedicated rechargeable battery and battery charger with this camera.

Using a non-genuine rechargeable battery and/or battery charger may result in fire or personal injury due to leakage, heating, ignition or damage to the battery. Olympus does not assume any liability for accidents or damage that may result from the use of a battery and/or battery charger that are not genuine Olympus accessories.

For customers in North and South America

For customers in USA

Declaration of Conformity

Model Number : E-M1

Trade Name : OLYMPUS

Responsible Party : **OLYMPUS IMAGING AMERICA INC.**

Address : 3500 Corporate Parkway, P. O. Box 610, Center Valley, PA 18034-0610, USA

Telephone Number : 484-896-5000

Tested To Comply With FCC Standards

FOR HOME OR OFFICE USE

This device complies with Part 15 of FCC Rules and Industry Canada licence-exempt RSS standard(s).

Operation is subject to the following two conditions:

- (1) This device may not cause harmful interference.
- (2) This device must accept any interference received, including interference that may cause undesired operation.

For customers in Canada

This Class B digital apparatus complies with Canadian ICES-003. CAN ICES-3(B)

OLYMPUS WORLDWIDE LIMITED WARRANTY - IMAGING PRODUCTS

Olympus warrants that the enclosed Olympus® imaging product(s) and related Olympus® accessories (individually a "Product" and collectively the "Products") will be free from defects in materials and workmanship under normal use and service for a period of one (1) year from the date of purchase.

If any Product proves to be defective within the one-year warranty period, the customer must return the defective Product to any of Olympus Service Centers, following the procedure set forth below (See "WHAT TO DO WHEN SERVICE IS NEEDED").

Olympus, at its sole discretion, will repair, replace, or adjust the defective Product, provided that Olympus investigation and factory inspection disclose that (a) such defect developed under normal and proper use and (b) the Product is covered under this limited warranty.

Repair, replacement, or adjustment of defective Products shall be Olympus's sole obligation and the customer's sole remedy hereunder.

The customer is liable and shall pay for shipment of the Products to the Olympus Service Center.

Olympus shall not be obligated to perform preventive maintenance, installation, deinstallation, or maintenance.

Olympus reserves the right to (i) use reconditioned, refurbished, and/or serviceable used parts (that meet Olympus's quality assurance standards) for warranty or any other repairs and (ii) make any internal or external design and/or feature changes on or to its products without any liability to incorporate such changes on or to the Products.

WHAT IS NOT COVERED BY THIS LIMITED WARRANTY

Excluded from this limited warranty and not warranted by Olympus in any fashion, either express, implied, or by statute, are:

- (a) products and accessories not manufactured by Olympus and/or not bearing the "OLYMPUS" brand label (the warranty coverage for products and accessories of other manufacturers, which may be distributed by Olympus, is the responsibility of the manufacturers of such products and accessories in accordance with the terms and duration of such manufacturers' warranties);
- (b) any Product which has been disassembled, repaired, tampered with, altered, changed, or modified by persons other than Olympus's own authorized service personnel unless repair by others is made with the written consent of Olympus;
- (c) defects or damage to the Products resulting from wear, tear, misuse, abuse, negligence, sand, liquids, impact, improper storage, nonperformance of scheduled operator and maintenance items, battery leakage, use of non-"OLYMPUS" brand accessories, consumables, or supplies, or use of the Products in combination with non-compatible devices;
- (d) software programs;
- (e) supplies and consumables (including but not limited to lamps, ink, paper, film, prints, negatives, cables and batteries); and/or
- (f) Products which do not contain a validly placed and recorded Olympus serial number, unless they are a model on which Olympus does not place and record serial numbers.

EXCEPT FOR THE LIMITED WARRANTY SET FORTH ABOVE, OLYMPUS MAKES NO AND DISCLAIMS ALL OTHER REPRESENTATIONS, GUARANTIES, CONDITIONS, AND WARRANTIES CONCERNING THE PRODUCTS, WHETHER DIRECT OR INDIRECT, EXPRESS OR IMPLIED, OR ARISING UNDER ANY STATUTE, ORDINANCE, COMMERCIAL USAGE OR OTHERWISE, INCLUDING BUT NOT LIMITED TO ANY WARRANTY OR REPRESENTATION AS TO THE SUITABILITY, DURABILITY, DESIGN, OPERATION, OR CONDITION OF THE PRODUCTS (OR ANY PART THEREOF) OR THE MERCHANTABILITY OF THE PRODUCTS OR THEIR FITNESS FOR A PARTICULAR PURPOSE, OR RELATING TO THE INFRINGEMENT OF ANY PATENT, COPYRIGHT, OR OTHER PROPRIETARY RIGHT USED OR INCLUDED THEREIN.

IF ANY IMPLIED WARRANTIES APPLY AS A MATTER OF LAW, THEY ARE LIMITED IN DURATION TO THE LENGTH OF THIS LIMITED WARRANTY.

SOME STATES MAY NOT RECOGNIZE A DISCLAIMER OR LIMITATION OF WARRANTIES AND/OR LIMITATION OF LIABILITY SO THE ABOVE DISCLAIMERS AND EXCLUSIONS MAY NOT APPLY.

THE CUSTOMER MAY ALSO HAVE DIFFERENT AND/OR ADDITIONAL RIGHTS AND REMEDIES THAT VARY FROM STATE TO STATE.

THE CUSTOMER ACKNOWLEDGES AND AGREES THAT OLYMPUS SHALL NOT BE RESPONSIBLE FOR ANY DAMAGES THAT THE CUSTOMER MAY INCUR FROM DELAYED SHIPMENT, PRODUCT FAILURE, PRODUCT DESIGN, SELECTION, OR PRODUCTION, IMAGE OR DATA LOSS OR IMPAIRMENT OR FROM ANY OTHER CAUSE, WHETHER LIABILITY IS ASSERTED IN CONTRACT, TORT (INCLUDING NEGLIGENCE AND STRICT PRODUCT LIABILITY) OR OTHERWISE. IN NO EVENT SHALL OLYMPUS BE LIABLE FOR ANY INDIRECT, INCIDENTAL, CONSEQUENTIAL OR SPECIAL DAMAGES OF ANY KIND (INCLUDING WITHOUT LIMITATION LOSS OF PROFITS OR LOSS OF USE), WHETHER OR NOT OLYMPUS SHALL BE OR SHOULD BE AWARE OF THE POSSIBILITY OF SUCH POTENTIAL LOSS OR DAMAGE.

Representations and warranties made by any person, including but not limited to dealers, representatives, salespersons, or agents of Olympus, which are inconsistent or in conflict with or in addition to the terms of this limited warranty, shall not be binding upon Olympus unless reduced to writing and approved by an expressly authorized officer of Olympus.

This limited warranty is the complete and exclusive statement of warranty which Olympus agrees to provide with respect to the Products and it shall supersede all prior and contemporaneous oral or written agreements, understandings, proposals, and communications pertaining to the subject matter hereof.

This limited warranty is exclusively for the benefit of the original customer and cannot be transferred or assigned.

WHAT TO DO WHEN SERVICE IS NEEDED

The customer must transfer any image or other data saved on a Product to another image or data storage medium and/or remove any film from the Product prior to sending the Product to Olympus for service.

IN NO EVENT SHALL OLYMPUS BE RESPONSIBLE FOR SAVING, KEEPING OR MAINTAINING ANY IMAGE OR DATA SAVED ON A PRODUCT RECEIVED BY IT FOR SERVICE, OR ON ANY FILM CONTAINED WITHIN A PRODUCT RECEIVED BY IT FOR SERVICE, NOR SHALL OLYMPUS BE RESPONSIBLE FOR ANY DAMAGES IN THE EVENT ANY IMAGE OR DATA IS LOST OR IMPAIRED WHILE SERVICE IS BEING PERFORMED (INCLUDING, WITHOUT LIMITATION, DIRECT, INDIRECT, INCIDENTAL, CONSEQUENTIAL OR SPECIAL DAMAGES, LOSS OF PROFITS OR LOSS OF USE), WHETHER OR NOT OLYMPUS SHALL BE OR SHOULD BE AWARE OF THE POSSIBILITY OF SUCH POTENTIAL LOSS OR IMPAIRMENT.

Package the Product carefully using ample padding material to prevent damage in transit and either deliver it to the Authorized Olympus Dealer that sold you the Product or ship it postage prepaid and insured to any of our Olympus Service Centers.

When returning Products for service, your package should include the following:

- 1 Sales receipt showing date and place of purchase.
- 2 Copy of this limited warranty **bearing the Product serial number corresponding to the serial number on the Product** (unless it is a model on which Olympus does not place and record serial numbers).
- 3 A detailed description of the problem.

- 4 Sample prints, negatives, digital prints (or files on disk) if available and related to the problem.

When service is completed, the Product will be returned to you postage prepaid.

WHERE TO SEND PRODUCT FOR SERVICE

See "WORLDWIDE WARRANTY" for the nearest service center.

INTERNATIONAL WARRANTY SERVICE

International warranty service is available under this warranty.

For customers in Europe



"CE" mark indicates that this product complies with the European requirements for safety, health, environment and customer protection. "CE" mark cameras are intended for sales in Europe. Hereby, Olympus Imaging Corp. and Olympus Europa SE & Co. KG declare that this E-M1 is in compliance with the essential requirements and other relevant provisions of Directive 1999/5/EC. For details visit: <http://olympus-europa.com/>



This symbol [crossed-out wheeled bin WEEE Annex IV] indicates separate collection of waste electrical and electronic equipment in the EU countries.

Please do not throw the equipment into the domestic refuse.

Please use the return and collection systems available in your country for the disposal of this product.



This symbol [crossed-out wheeled bin Directive 2006/66/EC Annex II] indicates separate collection of waste batteries in the EU countries.

Please do not throw the batteries into the domestic refuse.

Please use the return and collection systems available in your country for the disposal of the waste batteries.

Provisions of warranty

- 1 If this product proves to be defective, although it has been used properly (in accordance with the written Handling Care and Operating instructions supplied with it), during the applicable national warranty period and has been purchased from an authorized Olympus distributor within the business area of Olympus Europa SE & Co. KG as stipulated on the website: <http://www.olympus.com> this product will be repaired, or at Olympus's option replaced, free of charge. To claim under this warranty the customer must take the product before the end of the applicable national warranty period to the dealer where the product was purchased or any other Olympus service station within the business area of Olympus Europa SE & Co. KG as stipulated on the website: <http://www.olympus.com>. During the one year period of the World Wide Guarantee the customer may turn the product in at any Olympus service station. Please notice that not in all countries such Olympus service station exists.
- 2 The customer shall transport the product to the dealer or Olympus authorized service station at his own risk and shall be responsible for any costs incurred in transporting the product.

Provisions of Guarantee

- 1 "OLYMPUS IMAGING CORP." grants a one year World Wide Guarantee. This worldwide Guarantee must be presented at an Olympus authorized repair service station before any repair can be made under conditions of this Guarantee. This Guarantee is valid only if the Guarantee Certificate and proof of purchase are presented at the Olympus repair service station. Please note that this Guarantee is in addition to and does not affect the customer's legal warranty rights under the applicable national legislation governing the sale of consumer goods mentioned above.
- 2 This Guarantee does not cover the following and the customer will be required to pay repair charge, even for defects occurring within the Guarantee period referred to above.
 - (a) Any defect that occurs due to mishandling (such as an operation performed that is not mentioned in the Handling Care or other sections of the instructions, etc.)
 - (b) Any defect that occurs due to repair, modification, cleaning, etc. performed by anyone other than Olympus or an Olympus authorized service station.

- (c) Any defect or damage that occurs due to transport, a fall, shock, etc. after purchase of the product.
 - (d) Any defect or damage that occurs due to fire, earthquake, flood damage, thunderbolt, other natural disasters, environmental pollution and irregular voltage sources.
 - (e) Any defect that occurs due to careless or improper storage (such as keeping the product under conditions of high temperature and humidity, near insect repellents such as naphthalene or harmful drugs, etc.), improper maintenance, etc.
 - (f) Any defect that occurs due to exhausted batteries, etc.
 - (g) Any defect that occurs due to sand, mud, etc. entering the inside of the product casing.
 - (h) When the Guarantee Certificate is not returned with the product.
 - (i) When any alterations whatsoever are made to the Guarantee Certificate regarding the year, month and date of purchase, the customer's name, the dealer's name, and the serial number.
 - (j) When proof of purchase is not presented with this Guarantee Certificate.
- 3 This Guarantee applies to the product only; the Guarantee does not apply to any other accessory equipment, such as the case, strap, lens cap and batteries.
 - 4 Olympus's sole liability under this Guarantee shall be limited to repairing or replacing the product. Any liability under the Guarantee for indirect or consequential loss or damage of any kind incurred or suffered by the customer due to a defect of the product, and in particular any loss or damage caused to any lenses, films, other equipment or accessories used with the product or for any loss resulting from a delay in repair or loss of data, is excluded. Compelling regulations by law remain unaffected by this.

Notes regarding Guarantee maintenance

- 1 This Guarantee will only be valid if the Guarantee Certificate is duly completed by Olympus or an authorized dealer or other documents contain sufficient proof. Therefore, please make sure that your name, the name of the dealer, the serial number and the year, month and date of purchase are all completed or the original invoice or the sales receipt (indicating the dealer's name, the date of purchase and product type) is attached to this Guarantee Certificate. Olympus reserves the right to refuse free-of-charge service if neither Guarantee Certificate is completed nor the above document is attached or if the information contained in it is incomplete or illegible.
- 2 Since this Guarantee Certificate will not be re-issued, keep it in a safe place.
 - Please refer to the list on the web site: <http://www.olympus.com> for the authorized international Olympus service network.

For customers in Thailand

This telecommunication equipment conforms to technical standard NTC TS 1012-2551.

This telecommunication equipment conforms to NTC technical requirement.

For customers in Mexico

The operation of this equipment is subject to the following two conditions:

- (1) it is possible that this equipment or device may not cause harmful interference, and (2) this equipment or device must accept any interference, including interference that may cause undesired operation.

For customer in Singapore

Complies with IDA Standards DB104634
--

Trademarks

- Microsoft and Windows are registered trademarks of Microsoft Corporation.
- Macintosh is a trademark of Apple Inc.
- SDXC Logo is a trademark of SD-3C, LLC.
- Eye-Fi is a trademark of Eye-Fi, Inc.
- "Shadow Adjustment Technology" function contains patented technologies from Apical Limited.
- Micro Four Thirds, Four Thirds, and the Micro Four Thirds and Four Thirds logos are trademarks or registered trademarks of the OLYMPUS IMAGING Corporation in Japan, the United States, the countries of the European Union, and other countries.
- "PENPAL" is used in reference to the OLYMPUS PENPAL.
- Wi-Fi is a registered trademark of the Wi-Fi Alliance.
- The Wi-Fi CERTIFIED logo is a certification mark of the Wi-Fi Alliance.
- The standards for camera file systems referred to in this manual are the "Design Rule for Camera File System/DCF" standards stipulated by the Japan Electronics and Information Technology Industries Association (JEITA).
- All other company and product names are registered trademarks and/or trademarks of their respective owners.



THIS PRODUCT IS LICENSED UNDER THE AVC PATENT PORTFOLIO LICENSE FOR THE PERSONAL AND NONCOMMERCIAL USE OF A CONSUMER TO (i) ENCODE VIDEO IN COMPLIANCE WITH THE AVC STANDARD ("AVC VIDEO") AND/OR (ii) DECODE AVC VIDEO THAT WAS ENCODED BY A CONSUMER ENGAGED IN A PERSONAL AND NON-COMMERCIAL ACTIVITY AND/OR WAS OBTAINED FROM A VIDEO PROVIDER LICENSED TO PROVIDE AVC VIDEO. NO LICENSE IS GRANTED OR SHALL BE IMPLIED FOR ANY OTHER USE. ADDITIONAL INFORMATION MAY BE OBTAINED FROM MPEG LA, L.L.C. SEE [HTTP://WWW.MPEGLA.COM](http://www.MPEGLA.COM)

The software in this camera may include third party software. Any third party software is subject to the terms and conditions, imposed by the owners or licensors of that software, under which software is provided to you.

Those terms and other third party software notices, if any, may be found in the software notice PDF file stored within the accompanying CD-ROM or at

<http://www.olympus.co.jp/en/support/imsig/digicamera/download/notice/notice.cfm>

Index

Symbols

RC Mode.....	131
(Language selection).....	88
Menu Display.....	88
Set Home.....	90
Face Priority.....	53, 91
H fps.....	91
L fps.....	91
+ IS Off.....	91
Info Settings.....	92
Control Settings.....	92
Slow Limit.....	94
X-Sync.....	94
+WB.....	94
Warning Level.....	95
(Underwater wide/underwater macro).....	100
(Index display).....	61
(Close-up playback).....	61
(Movie mode).....	42
Mode.....	97
(Single-frame erase).....	33
(Picture selection).....	33
(Protecting).....	32, 64
(AF Area).....	52
Keep Warm Color.....	95
(Image rotation).....	85
Set.....	95
(Beep sound).....	93
(Audio recording).....	64
(Monitor brightness adjustment).....	88
(Slideshow).....	65
Lever Function.....	91

A

A (Aperture priority mode).....	39
Address Book.....	110
AEL/AFL.....	90, 98
AEL Metering.....	94
AF Illuminat.....	91
AF Mode.....	73, 90
Album Mem. Usage.....	111
All	95
Anti-Shock	94
ART (Art filter mode).....	44
Art Fade.....	42
Art LV Mode.....	93
Aspect.....	69

B

Backlit LCD.....	93
Bracketing.....	80
BULB.....	41
BULB/TIME Focusing.....	90
BULB/TIME Monitor.....	94
BULB/TIME Timer.....	94
Button Function.....	91

C

Card Setup.....	76
Color Space.....	95
Connection to Smartphone.....	87
Copy All.....	111
Copyright Settings.....	96

D

Date/time setting	17
Dial Direction.....	91
Dial Function.....	91
Digital Tele-converter.....	84, 100
Displayed Grid.....	92
dpi Settings.....	96

E

Edit Filename.....	96
--------------------	----

Erase Selected	33
EVF Adjust.....	111
EV Step	93
Exposure Shift	98
Eye-Fi	98

F

File Name	96
Firmware.....	88
Flash intensity control 	71
Flicker reduction	93
Focus Ring	90
Full-time AF	90

H

Half Way RIs With IS	91
HDMI	92
HDR.....	59
Highlight&Shadow Control.....	49
Histogram Settings	92

I

IAUTO (iAuto mode).....	18, 22, 26
Image Aspect.....	69
Image Overlay	87
Image Stabilizer.....	66
INFO button	37, 49, 60
ISO	57, 94
ISO-Auto.....	94
ISO-Auto Set	94
ISO Step	94



J

JPEG Edit.....	86
----------------	----

L

Lens I.S. Priority	92
Level Adjust	98
Live BULB.....	94
Live Control	30
Live Guide	28, 100
Live TIME	94
LIVE TIME	41
Live View Boost.....	92
LV super control panel.....	103

M

M (Manual shooting)	41
Metering.....	72
MF	100
MF Assist.....	90, 99
Mode Dial Function.....	91
Mode Guide.....	92
Movie 	74, 97
Movie Play	63
Movie Tele-converter	43
MTP.....	118
Multi Echo.....	42
Multi Function	23, 100
Multiple Exposure 	82
My OLYMPUS PENPAL.....	110

N

Noise Filter	94
Noise Reduct.....	93

O

OLYMPUS PENPAL Album	111
OLYMPUS PENPAL Share.....	109, 110
One Shot Echo	42

P

P (Program shooting).....	38
Peaking Settings.....	93
Picture Copy Size	111
Picture Mode	68, 78
Picture Mode Settings	92
Pixel Count.....	95
Pixel Mapping.....	141
Print	113
Print reservation 	112
Priority Set	96

Q

Quick Erase.....	96
------------------	----

R

RAW Data Edit	85
RAW+JPEG Erase	96
Recording Volume	97

Rec View	88
Release Lag-Time	92
Reset Lens	90
Reset/Myset.....	77
Reset Protect.....	87, 111
RIs Priority C.....	91
RIs Priority S.....	91
Rotate	64

S

S (Shutter priority shooting)	40
Shading Comp.....	95
Sleep	16, 93
Storage	118
Super Control Panel	24

T

Time Lapse Settings.....	83
Touch Screen Settings.....	98

U

USB Mode	93
----------------	----

V

Video Out.....	92
----------------	----

W

WB.....	56, 95
Wi-Fi Settings	89

OLYMPUS EUROPA SE & CO. KG

Premises: Consumer Product Division
Wendenstrasse 14 – 18, 20097 Hamburg, Germany
Tel.: +49 40 - 23 77 3-0 / Fax: +49 40 - 23 07 61

Goods delivery: Modul H, Willi-Bleicher Str. 36, 52353 Düren, Germany

Letters: Postfach 10 49 08, 20034 Hamburg, Germany

European Technical Customer Support:

Please visit our homepage <http://www.olympus-europa.com>
or call our TOLL FREE NUMBER*: **00800 - 67 10 83 00**

for Austria, Belgium, Czech Republic, Denmark, Finland, France, Germany, Luxemburg, Netherlands, Norway, Poland, Portugal, Russia, Spain, Sweden, Switzerland, United Kingdom.

* Please note some (mobile) phone services / provider do not permit access or request an additional prefix to +800 numbers.

For all not listed European Countries and in case that you can't get connected to the above mentioned number please make use of the following

CHARGED NUMBERS: **+49 40 - 237 73 899.**

Our Technical Customer Support is available from Monday to Thursday 9 am to 6 pm, Friday 9 am to 3:30 pm CET.

Authorized Distributors

United Kingdom: Olympus Service Department

/Eire
Olympus Imaging & Audio
KeyMed House
Stock Road
Southend-on-Sea
Essex
SS2 5QH
United Kingdom

South Africa: Tudortech (Pty) Ltd.

Ground floor, Building 1A,
Wedgefield Office Park,
17 Muswell Road,
Bryanston 219
South Africa
Tel: +27 (0) 11 803 2226
Fax: +27 (0) 86 639 5359

Service - 0800 111 4888
Fax: +44 (0) 1702 452763
E-mail: customer.support@olympus.co.uk
www.olympus.co.uk



<http://www.olympus.com/>

OLYMPUS IMAGING AMERICA INC.

3500 Corporate Parkway, P.O. Box 610, Center Valley, PA 18034-0610, U.S.A. Tel. 484-896-5000

Technical Support (U.S.A.)

24/7 online automated help: <http://www.olympusamerica.com/support>

Phone customer support: Tel. 1-800-260-1625 (Toll-free)

Our phone customer support is available from 9am to 9pm (Monday to Friday) ET

E-mail: distec@olympus.com

To find the nearest Service Centers, please visit: <http://olympusamerica.com/repair>

Service Centers

U.S.A./CANADA:

Olympus Imaging America Inc.

Tel: (888) 553-4448

<http://www.olympusamerica.com/repair>

Mexico:

Olympus Imaging de Mexico

S.A. de C.V.

Tel: 01 800 8002128

<http://www.olympus.com.mx>