

SAMSUNG

SM-P600

User Manual

www.samsung.com

About this manual

This device provides high quality mobile communication and entertainment using Samsung's high standards and technological expertise. This user manual is specially designed to detail the device's functions and features.

- Please read this manual before using the device to ensure safe and proper use.
- Descriptions are based on the device's default settings.
- Images and screenshots may differ in appearance from the actual product.
- Content may differ from the final product, or from software provided by service providers or carriers, and is subject to change without prior notice. For the latest version of the manual, refer to the Samsung website, www.samsung.com.
- Content (high quality content) that requires high CPU and RAM usage will affect the overall performance of the device. Applications related to the content may not work properly depending on the device's specifications and the environment that it is used in.
- Available features and additional services may vary by device, software, or service provider.
- Applications and their functions may vary by country, region, or hardware specifications. Samsung is not liable for performance issues caused by applications from any provider other than Samsung.
- Samsung is not liable for performance issues or incompatibilities caused by edited registry settings or modified operating system software. Attempting to customise the operating system may cause the device or applications to work improperly.
- Software, sound sources, wallpapers, images, and other media provided with this device are licensed for limited use. Extracting and using these materials for commercial or other purposes is an infringement of copyright laws. Users are entirely responsible for illegal use of media.
- You may incur additional charges for data services, such as messaging, uploading and downloading, auto-syncing, or using location services. To avoid additional charges, select an appropriate data tariff plan. For details, contact your service provider.

- Default applications that come with the device are subject to updates and may no longer be supported without prior notice. If you have questions about an application provided with the device, contact a Samsung Service Centre. For user-installed applications, contact service providers.
- Modifying the device's operating system or installing softwares from unofficial sources may result in device malfunctions and data corruption or loss. These actions are violations of your Samsung licence agreement and will void your warranty.

Instructional icons



Warning: situations that could cause injury to yourself or others



Caution: situations that could cause damage to your device or other equipment



Note: notes, usage tips, or additional information

Copyright

Copyright © 2013 Samsung Electronics

This guide is protected under international copyright laws.

No part of this guide may be reproduced, distributed, translated, or transmitted in any form or by any means, electronic or mechanical, including photocopying, recording, or storing in any information storage and retrieval system, without the prior written permission of Samsung Electronics.

Trademarks

- SAMSUNG and the SAMSUNG logo are registered trademarks of Samsung Electronics.
- The Android logo, Google™, Google Maps™, Google Mail™, YouTube™, Google Play™ Store, and Google Talk™ are trademarks of Google, Inc.
- Bluetooth® is a registered trademark of Bluetooth SIG, Inc. worldwide.
- Wi-Fi®, Wi-Fi Protected Setup™, Wi-Fi Direct™, Wi-Fi CERTIFIED™, and the Wi-Fi logo are registered trademarks of the Wi-Fi Alliance.
- All other trademarks and copyrights are the property of their respective owners.

Table of Contents

Getting started

- 7 Device layout
- 8 Buttons
- 9 S Pen
- 9 Package contents
- 10 Charging the battery
- 12 Inserting a memory card
- 14 Replacing the S Pen nib
- 15 Turning the device on and off
- 15 Holding the device
- 16 Adjusting the volume
- 16 Switching to silent mode

Basics

- 17 Indicator icons
- 18 Using the touch screen
- 21 Control motions
- 23 Palm motions
- 24 Using the S Pen
- 28 Air view
- 28 Samsung Smart Pause
- 29 Samsung Smart Scroll
- 29 Activating Multi Window
- 31 Notifications
- 31 Notifications panel
- 32 Home screen
- 35 Locked screen

- 36 Using applications
- 37 Applications screen
- 38 Help
- 38 Entering text
- 41 Connecting to a Wi-Fi network
- 42 Setting up accounts
- 43 Transferring files
- 44 Securing the device
- 46 Upgrading the device

Communication

- 47 Contacts
- 51 Email
- 52 Google Mail
- 54 Hangouts
- 54 Google+
- 55 ChatON
- 55 Twitter

Web & network

- 56 Internet
- 57 Chrome
- 58 Bluetooth
- 59 Screen Mirroring
- 60 Samsung Link
- 60 Group Play

61 WatchON

Media

62 Music

64 Camera

71 Gallery

75 Story Album

75 Video

76 Video Editor

77 YouTube

78 My Magazine

79 Flipboard

79 SketchBook for Galaxy

80 Businessweek+

80 NYTimes

Application & media stores

81 Play Store

82 Samsung Hub

82 Samsung Apps

83 Play Books

83 Play Movies

83 Play Music

83 Play Games

Utilities

84 S Note

89 S Planner

91 POLARIS Office 5

93 Dropbox

94 Cloud

95 Alarm

96 World Clock

96 Calculator

96 S Translator

97 S Voice

98 S Finder

98 Google

99 Scrapbook

100 Voice Search

100 My Files

101 Downloads

101 TripAdvisor

102 Evernote

102 KNOX

Travel & local

103 Maps

Settings

104 About Settings

104 Connections

107 Device

111 Controls

116 General

119 Google Settings

Troubleshooting

Getting started

Device layout

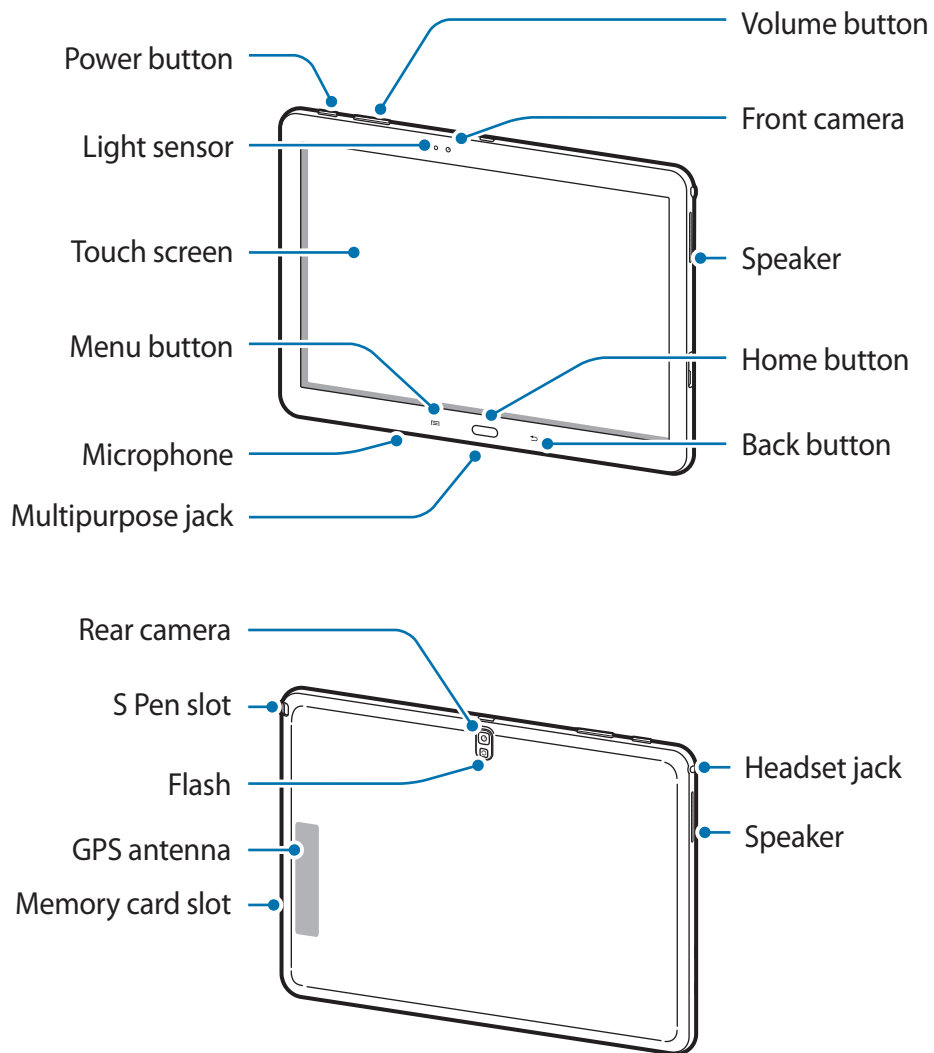





The microphone at the top of the device is active only when you use the speakerphone or take videos.



- Do not cover the antenna area with your hands or other objects. This may cause connectivity problems or drain the battery.
- Do not use a screen protector. This causes sensor malfunctions.
- Do not allow water to contact the touch screen. The touch screen may malfunction in humid conditions or when exposed to water.

Buttons

Button	Function
 Power	<ul style="list-style-type: none"> • Press and hold to turn the device on or off. • Press and hold for more than 7 seconds to reset the device if it has fatal errors or hang-ups, or freezes. • Press to lock or unlock the device. The device goes into lock mode when the touch screen turns off.
 Menu	<ul style="list-style-type: none"> • Tap to open a list of options available for the current screen. • Tap and hold on the Home screen to launch S Finder.
 Home	<ul style="list-style-type: none"> • Press to return to the Home screen. • Press and hold to open the list of recent applications.
 Back	<ul style="list-style-type: none"> • Tap to return to the previous screen.
 Volume	<ul style="list-style-type: none"> • Press to adjust the device volume.

S Pen

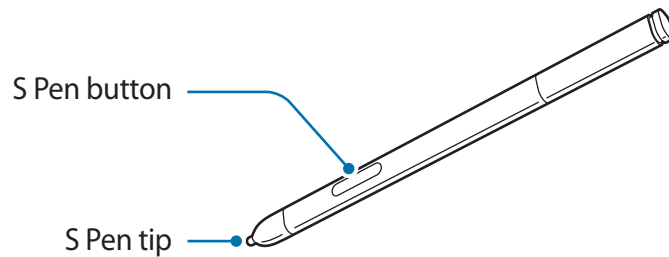

Name	Function
S Pen tip	<ul style="list-style-type: none"> • Perform basic S Pen actions. (p. 18)
S Pen button	<ul style="list-style-type: none"> • Perform advanced S Pen actions. (p. 24)

Package contents

Check the product box for the following items:

- Device
- Quick start guide



- The items supplied with the device and any available accessories may vary depending on the region or service provider.
- The supplied items are designed only for this device and may not be compatible with other devices.
- Appearances and specifications are subject to change without prior notice.
- You can purchase additional accessories from your local Samsung retailer. Make sure they are compatible with the device before purchase.
- Other accessories may not be compatible with your device.
- Use only Samsung-approved accessories. Malfunctions caused by using unapproved accessories are not covered by the warranty service.
- Availability of all accessories is subject to change depending entirely on manufacturing companies. For more information about available accessories, refer to the Samsung website.

Charging the battery

Use the charger to charge the battery before using it for the first time. A computer can be also used to charge the device by connecting them via the USB cable.



Use only Samsung-approved chargers, batteries, and cables. Unapproved chargers or cables can cause the battery to explode or damage the device.



- When the battery power is low, the device emits a warning tone and displays a low battery power message.
- If the battery is completely discharged, the device cannot be turned on immediately when the charger is connected. Allow a depleted battery to charge for a few minutes before turning on the device.
- If you use multiple applications at once, network applications, or applications that need a connection to another device, the battery will drain quickly. To avoid disconnecting from the network or losing power during a data transfer, always use these applications after fully charging the battery.

Charging with the charger

Connect the USB cable to the USB power adaptor and then plug the end of the USB cable into the multipurpose jack.

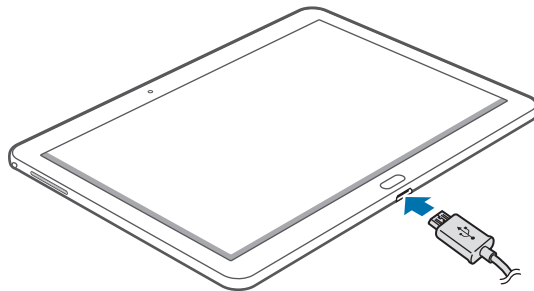

Connecting the charger improperly may cause serious damage to the device. Any damage caused by misuse is not covered by the warranty.



- The device can be used while it is charging, but it may take longer to fully charge the battery.
- If the device receives an unstable power supply while charging, the touch screen may not function. If this happens, unplug the charger from the device.
- While charging, the device may heat up. This is normal and should not affect the device's lifespan or performance. If the battery gets hotter than usual, the charger may stop charging.
- If the device is not charging properly, take the device and the charger to a Samsung Service Centre.

After fully charging, disconnect the device from the charger. First unplug the charger from the device, and then unplug it from the electric socket.



Do not remove the battery before removing the charger. This may damage the device.



To save energy, unplug the charger when not in use. The charger does not have a power switch, so you must unplug the charger from the electric socket when not in use to avoid wasting power. The charger should remain close to the electric socket and easily accessible while charging.

Checking the battery charge status

When you charge the battery while the device is off, the following icons will show the current battery charge status:



Charging



Fully charged

Reducing the battery consumption

Your device provides options that help you save battery power. By customising these options and deactivating features in the background, you can use the device longer between charges:

- When you are not using the device, switch to sleep mode by pressing the Power button.
- Close unnecessary applications with the task manager.
- Deactivate the Bluetooth feature.
- Deactivate the Wi-Fi feature.
- Deactivate auto-syncing of applications.
- Decrease the backlight time.
- Decrease the brightness of the display.

Inserting a memory card

Your device accepts memory cards with maximum capacities of 64 GB. Depending on the memory card manufacturer and type, some memory cards may not be compatible with your device.



- Some memory cards may not be fully compatible with the device. Using an incompatible card may damage the device or the memory card, or corrupt the data stored in it.
- Use caution to insert the memory card right-side up.



- The device supports the FAT and the exFAT file systems for memory cards. When inserting a card formatted in a different file system, the device asks to reformat the memory card.
- Frequent writing and erasing of data shortens the lifespan of memory cards.
- When inserting a memory card into the device, the memory card's file directory appears in the **My Files** → **All** → **SD memory card** folder.

- 1 Insert a memory card with the gold-coloured contacts facing downwards.
- 2 Push the memory card into the slot until it locks in place.

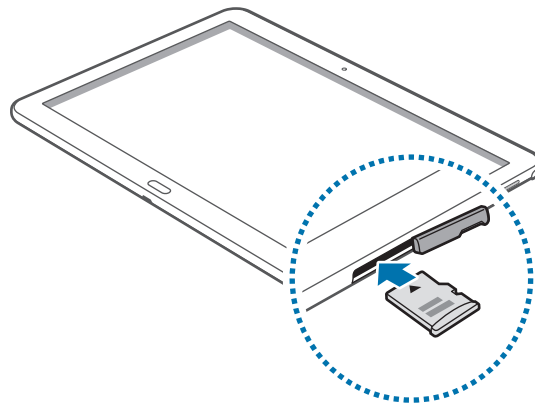

Removing the memory card

Before removing the memory card, first unmount it for safe removal. On the Home screen, tap  → **Settings** → **General** → **Storage** → **Unmount SD card**.

Push the memory card until it disengages from the device, and then pull it out.



Do not remove the memory card while the device is transferring or accessing information. Doing so can cause data to be lost or corrupted or damage to the memory card or device. Samsung is not responsible for losses that result from the misuse of damaged memory cards, including the loss of data.

Formatting the memory card

A memory card formatted on a computer may not be compatible with the device. Format the memory card on the device.

On the Home screen, tap  → **Settings** → **General** → **Storage** → **Format SD card** → **Format SD card** → **Erase everything**.



Before formatting the memory card, remember to make backup copies of all important data stored on the device. The manufacturer's warranty does not cover loss of data resulting from user actions.

Replacing the S Pen nib

While using the S Pen, the S Pen nib may get dull. If the nib is dull, replace it with a new one.

- 1 Hold the nib with the tweezers firmly, and then pull it out.

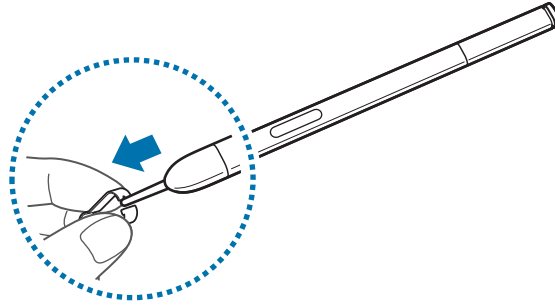

- 2 Insert a new nib into the S Pen until you hear a click.

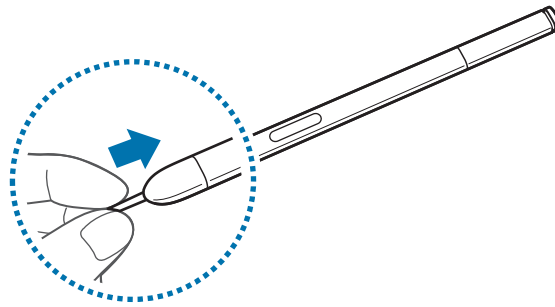

Do not let your finger get caught between the tweezers and the nib.



- Do not reuse old nibs. Doing so may cause the S Pen to malfunction.
- Do not press the nib excessively when inserting the nib into the S Pen.
- Do not insert the round end of the nib into the S Pen. This may cause damage to the S Pen or device.



The black-coloured nib has a white rubber cap on the tip. If the rubber cap is worn down, replace the nib with a new one.

Turning the device on and off

When turning on the device for the first time, follow the on-screen instructions to set up your device.

Press and hold the Power button for a few seconds to turn on the device on and off.

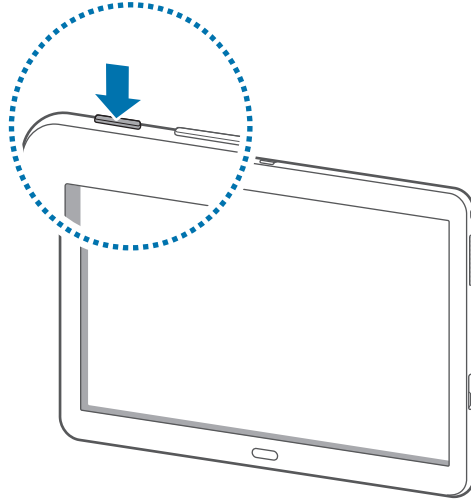

- Follow all posted warnings and directions from authorised personnel in areas where the use of wireless devices is restricted, such as aeroplanes and hospitals.
- Press and hold the Power button and tap **Flight mode** to disable the wireless features.

To turn off the device, press and hold the Power button, and then tap **Power off**.

Holding the device

Do not cover the antenna area with your hands or other objects. This may cause connectivity problems or drain the battery.

Adjusting the volume

Press the Volume button up or down to adjust the ringtone volume, or to adjust the sound volume when playing music or video.

Switching to silent mode













Use one of the following methods:

- Press and hold the Volume button down until it switches to silent mode.
- Press and hold the Power button, and then tap **Mute** or **Vibrate**.
- Open the notifications panel at the top of the screen, and then tap **Sound** or **Vibrate**.

Basics

Indicator icons

The icons displayed at the top of the screen provide information about the status of the device. The icons listed in the table below are most common.

Icon	Meaning
	Wi-Fi connected
	Bluetooth feature activated
	GPS activated
	Smart screen feature activated
	Synced with the web
	Connected to computer
	Alarm activated
	S Pen removed
	Silent mode activated
	Vibration mode activated
	Flight mode activated
	Error occurred or caution required
	Battery power level

Using the touch screen

Use only fingers or the S Pen to use the touch screen.



- Do not allow the touch screen to come into contact with other electrical devices. Electrostatic discharges can cause the touch screen to malfunction.
- To avoid damaging the touch screen, do not tap it with anything sharp or apply excessive pressure to it with your fingertips.



- The device may not recognise touch inputs close to the edges of the screen, which are outside of the touch input area.
- Leaving the touch screen idle for extended periods may result in afterimages (screen burn-in) or ghosting. Turn off the touch screen when you do not use the device.

Finger gestures

Tapping

To open an application, to select a menu item, to press an on-screen button, or to enter a character using the on-screen keyboard, tap it with a finger.

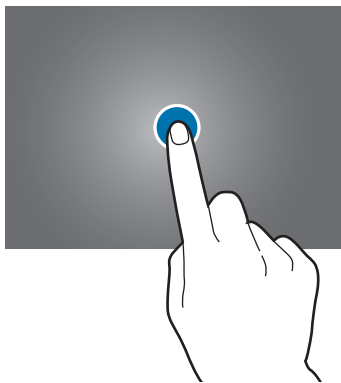

Tapping and holding

Tap and hold an item for more than 2 seconds to access available options.

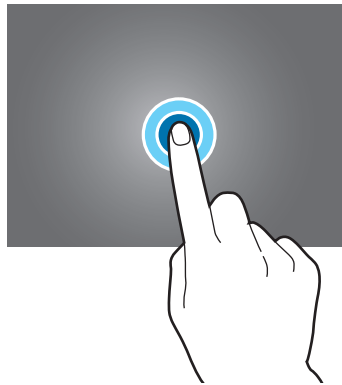

Dragging

To move an icon, thumbnail, or preview to a new location, tap and hold it and drag it to the target position.

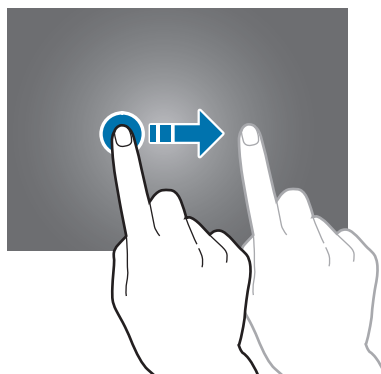

Double-tapping

Double-tap on a webpage, map, or image to zoom in a part. Double-tap again to return.

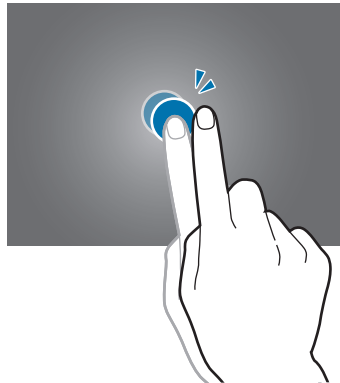

Flicking

Flick left or right on the Home screen or the Applications screen to see another panel. Flick up or down to scroll through a webpage or a list, such as contacts.

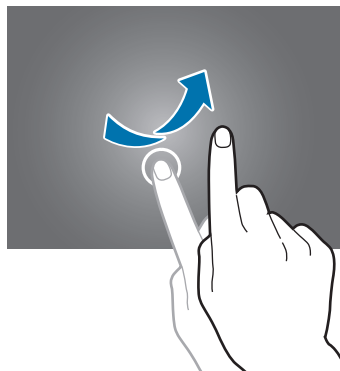

Pinching

Spread two fingers apart on a webpage, map, or image to zoom in a part. Pinch to zoom out.

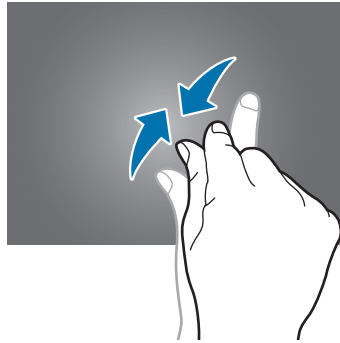

Control motions

Simple motions allow easy control of the device.

Before using motions, make sure the motion feature is activated. On the Home screen, tap  → **Settings** → **Controls** → **Motions**, and then drag the **Motions** switch to the right.



Excessive shaking or impact to the device may result in unintended inputs. Control motions properly.

Rotating the screen

Many applications allow display in either portrait or landscape orientation. Rotating the device causes the display to automatically adjust to fit the new screen orientation.

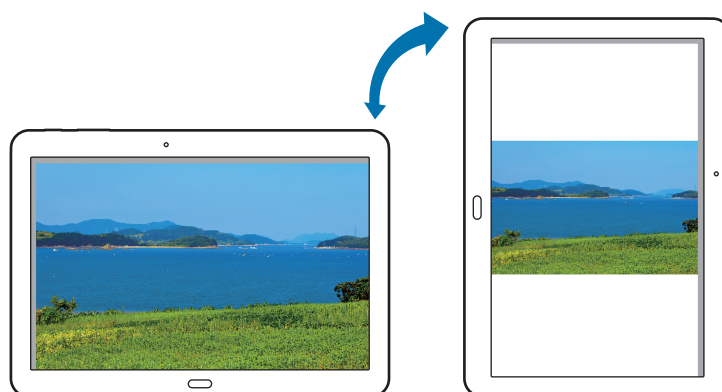

To prevent the display from rotating automatically, open the notifications panel and deselect **Screen rotation**.



- Some applications do not allow screen rotation.
- Some applications display a different screen depending on the orientation.

Tilting

Tap and hold two points on the screen, and then tilt the device back and forth to zoom in or out.

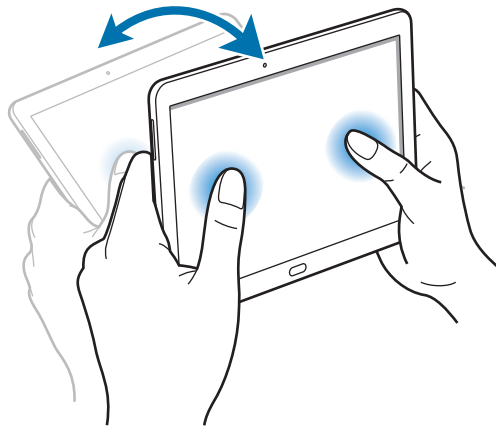

Panning to move

Tap and hold an item, and then move the device to the left or right to move the item to another panel on the Home screen or the Applications screen.

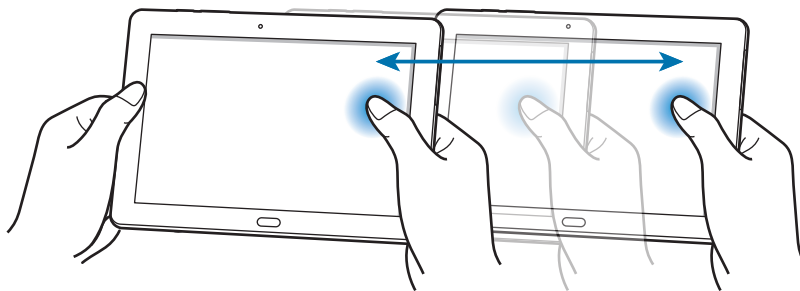

Panning to browse

When an image is zoomed in, tap and hold a point on the screen, and then move the device in any direction to browse the image.

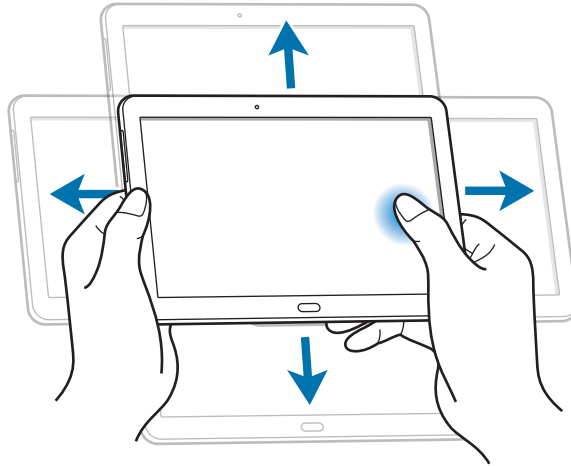

Palm motions

Use palm motions to control the device by touching the screen.

Before using motions, make sure the palm motion feature is activated. On the Home screen, tap  → **Settings** → **Controls** → **Palm motion**, and then drag the **Palm motion** switch to the right.

Sweeping

Sweep your hand across the screen to capture a screenshot. The image is saved in **Gallery** → **Albums** → **Screenshots**. It is not possible to capture a screenshot while using some applications.

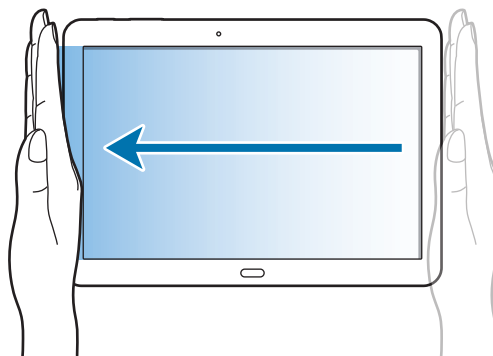

Covering

Cover the screen with a palm to pause media playback.

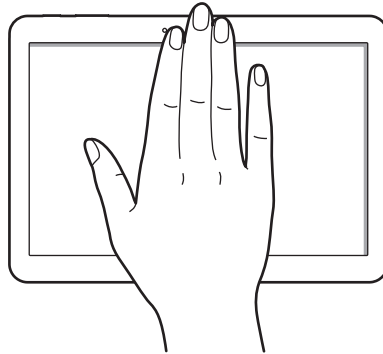

Using the S Pen

The included S Pen can be used to easily select items or perform functions. Actions using the S Pen with the button pressed provide additional conveniences, such as screen capture.

Pull out the S Pen from the slot to use it.

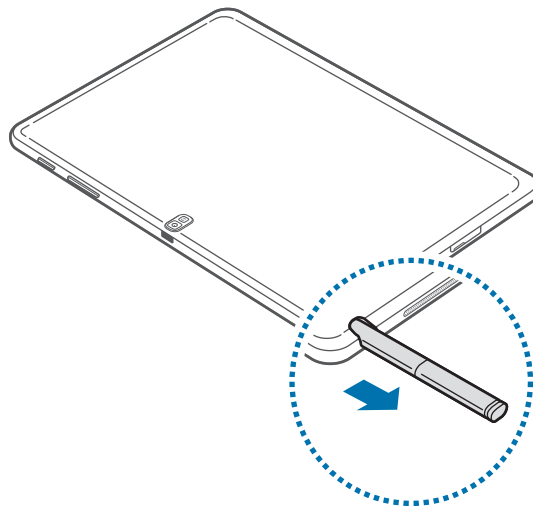

When you pull out the S Pen from the slot, the device detects it and performs the following:

- Turns on the touch screen (if it is off).
- Launches Action Memo, or display air command.



- The pen nib of the S Pen is replaceable. If the pen nib gets dull, replace it with a new one.
- If the S Pen is not working properly, take it to a Samsung Service Centre. Refer to the Samsung website for more information about the S Pen.
- For best results, keep the S Pen mostly perpendicular to the touch screen and avoid using it at sharp angles.

Capturing screenshots

With the S Pen button pressed, touch the screen until you hear a click. A screenshot is saved in the **Gallery** → **Screenshots** folder.

It is possible to draw or write on or to crop a screenshot. The edited image is saved in the **Gallery** → **IMG_edited** folder.

It is not possible to capture a screenshot while using some applications.

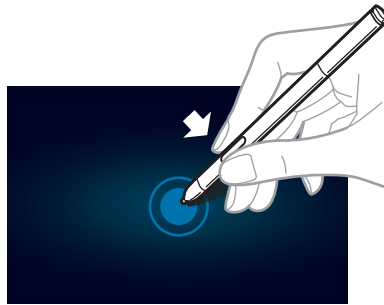

Launching Action Memo

With the S Pen button pressed, double-tap the screen to launch Action Memo.



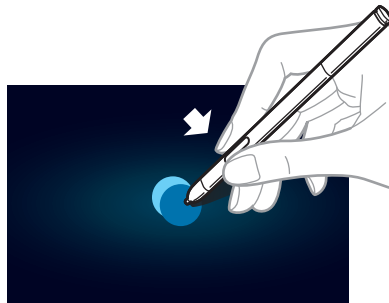

Jot down or draw a note, and then select the memo by tapping  to perform various actions, such as adding contacts or sending an email. With the memo selected, draw a line around an area with the S Pen to perform actions with the selected area.



Selecting and capturing an image

With the S Pen button pressed, draw a line around an area to select it.

If necessary, use one of the following options:

-  : Restore the original selection.
-  : Convert the selection to circular shape.
-  : Convert the selection to rectangular shape.
-  : Customise the selection.

Select an application to use with the selected area from the icons that appear at the bottom of the screen.

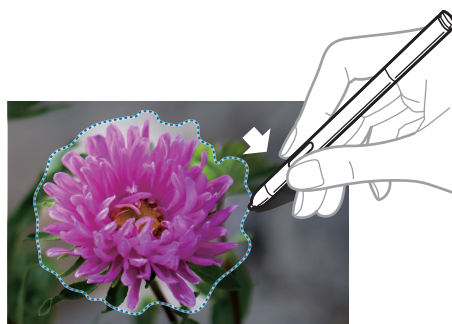

Using air command

Press the S Pen button while hovering the S Pen over the screen.

In most case, air command appear on the screen when pressing the S Pen button.

Use the following actions:

- **Action Memo:** Launch Action Memo.
- **Scrapbooker:** Select and capture an image, and then save the image into **Scrapbook**.
- **Screen Write:** Capture a screenshot and edit it with the S Pen.
- **S Finder:** Launch **S Finder**.
- **Pen Window:** Launch multiple applications in specified areas on the screen.

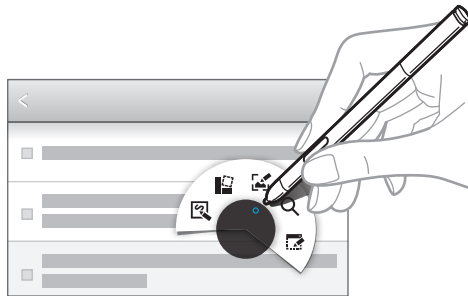

Some items have contextual menus that make the S Pen pointer glow. Press the S Pen button to display the menu while hovering the S Pen over the item.

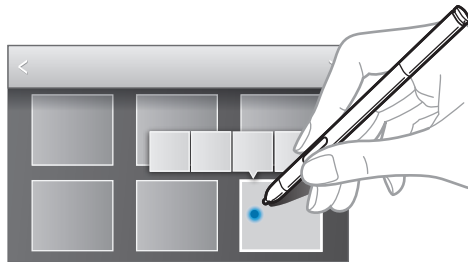

Air view

Use this feature to perform various functions while the S Pen is hovering over the screen.

On the Home screen, tap  → **Settings** → **Controls** → **S Pen** → **Air view**, and then drag the **Air view** switch to the right.

Point at an item with the S Pen to preview content or view information in a pop-up window.

You can scroll through panels or lists by moving the S Pen pointer to an edge (top/bottom/left/right) of the screen.

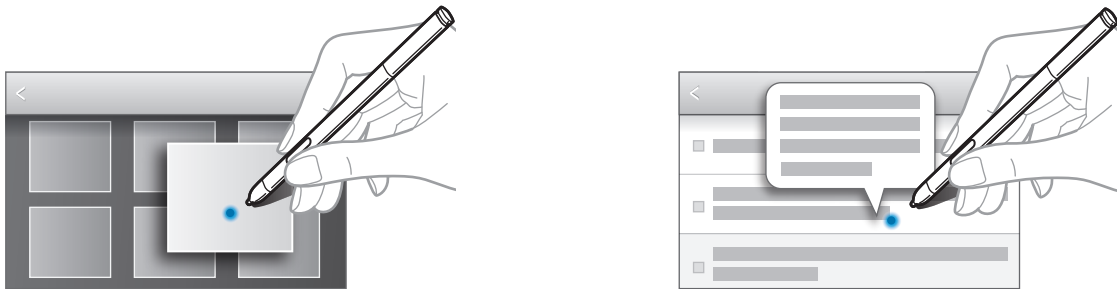

Samsung Smart Pause

Use this feature to pause videos when you look away from the screen.

On the Home screen, tap  → **Settings** → **Controls** → **Smart screen**, and then tick **Smart pause**.

During video playback, look away from the screen to pause the video. To resume playback, look at the screen again.

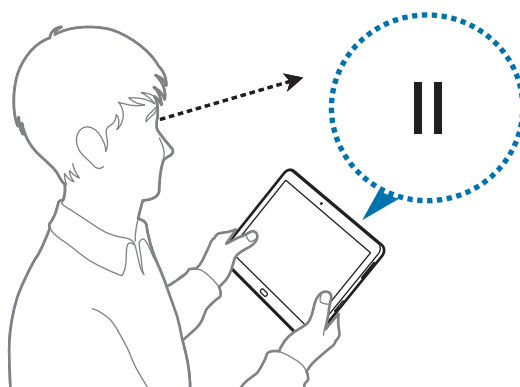



Samsung Smart Scroll

Use this feature to scroll the screen up or down by tilting your head or the device.

On the Home screen, tap  → **Settings** → **Controls** → **Smart screen** → **Smart scroll**, and then drag the **Smart scroll** switch to the right. Tap **Smart scroll**, and then select a scroll type.

When you are viewing emails or webpages, the scroll type icon ( for head orientation) that shows the recognition status for movements appears.

When the device recognises your head or device's movements, the icon is changed to  or . Then, tilt your head downward or upward, or tilt the device forward or backward to scroll in that direction.

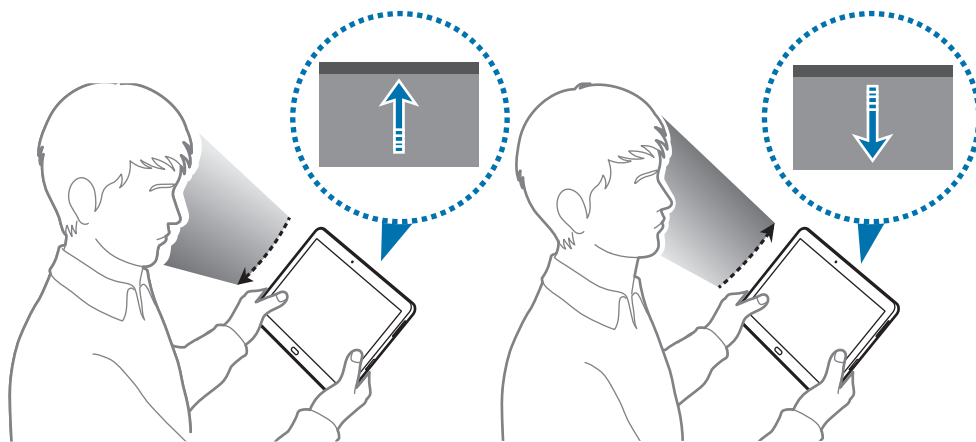

Activating Multi Window



Use this feature to run two applications on the screen at the same time.



- Only applications on the Multi Window panel can run.
- When launching applications that contain multimedia files, such as music or videos, sound from both files will be played.
- This feature may not be available depending on the region or service provider.

To use Multi Window, on the Applications screen, tap **Settings** → **Device** → **Multi window**, and then drag the **Multi window** switch to the right.

Using the Multi Window panel



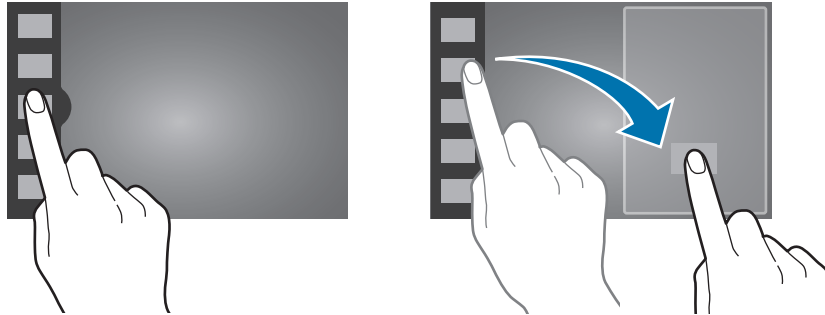

To show the Multi Window panel, tap and hold . The Multi Window panel appears on the left side of the screen. Select one application, and then drag another application to a new location. You can launch the same application on the two windows at the same time. To hide the Multi Window panel, tap and hold  again.



Drag the circle between the application panels left or right to adjust the size of the panels. Tap the panel handle to hide or show the panel. When a panel is open, tap and hold the handle and drag it to the left or right edge of the screen to move the panel. When a panel is hidden, tap and hold the handle and drag it up or down to move the handle.

Using Multi Window applications

While using Multi Window applications, select an application panel, tap the circle between the application panels, and then use one of the following:

- : Open a list of recently-used applications in the left or right window.
- : Switch locations between Multi Window applications.
- : Share items between the application windows. Drag an item to share from one window to another. Some applications may not support this feature.
- : Close the application.

Sharing files

Drag an item you want to share to the other window to share the item from one window to another.

Creating a paired window

Use this feature to save the combination of current running Multi Window applications.

On the Multi Window panel, tap  → **Create**, enter a title, and then tap **OK**.

Notifications

Notification icons appear on the status bar at the top of the screen to report new messages, calendar events, device status, and more. Drag down from the status bar to open the notifications panel. Scroll the list to see additional alerts. To close the notifications panel, drag up the bar that is at the bottom of the screen.

Notifications panel



From the notifications panel, you can view your device's current settings. Drag down from the status bar, and then tap  to use the following options:

- **Wi-Fi:** Activate or deactivate the Wi-Fi feature.
- **GPS:** Activate or deactivate the GPS feature.
- **Sound:** Activate or deactivate silent mode. You can vibrate or mute your device in silent mode.
- **Screen rotation:** Allow or prevent the interface from rotating when you rotate the device.
- **Bluetooth:** Activate or deactivate the Bluetooth feature.
- **Reading mode:** Activate or deactivate reading mode. In reading mode, the device helps protect your eyes when reading at night. To select which applications will be used for, tap **Settings** → **Device** → **Display** → **Reading mode**.
- **Blocking mode:** Activate or deactivate blocking mode. In blocking mode, the device will block notifications. To select which notifications will be blocked, tap **Settings** → **Device** → **Blocking mode**.

- **Power saving:** Activate or deactivate power-saving mode.
- **Multi window:** Set to use Multi Window.
- **Screen Mirroring:** Activate or deactivate the screen mirroring feature.
- **Air view:** Activate or deactivate the air view feature.
- **Smart stay:** Activate or deactivate the smart stay feature.
- **Smart pause:** Activate or deactivate the smart pause feature.
- **Smart scroll:** Activate or deactivate the smart scroll feature.
- **Sync:** Activate or deactivate auto-syncing of applications.
- **Flight mode:** Activate or deactivate flight mode.



The available options may vary depending on the region or service provider.

To rearrange the options on the notifications panel, open the notifications panel, tap  → , tap and hold an item, and then drag the item to another location.

Home screen

The Home screen is the starting point to access all of the device's features. It displays indicator icons, widgets, shortcuts to applications, and others.

The Home screen can have multiple panels. To view other panels, scroll left or right.

Rearranging items

Adding an application icon

On the Home screen, tap , tap and hold an application icon, and then drag it into a panel preview.

Adding an item

Customise the Home screen by adding widgets, folders, or panels.

Tap and hold the empty area on the Home screen, and then select one of the following categories:

- **Apps and widgets:** Add widgets or applications to the Home screen.
- **Folder:** Create a new folder.
- **Page:** Add a new panel to the Home screen.

Moving an item

Tap and hold an item and drag it to a new location. To move it to another panel, drag it to the side of the screen.

Removing an item

Tap and hold an item, and drag it to the rubbish bin that appears at the top of the Home screen. When the rubbish bin turns red, release the item.

Rearranging panels

Adding a new panel

Tap  → **Edit page** → .

Moving a panel

Tap  → **Edit page**, tap and hold a panel preview, and then drag it to a new location.

Removing a panel

Tap  → **Edit page**, tap and hold a panel preview, and then drag it to the rubbish bin at the top of the screen.

Setting wallpaper

Set an image or photo stored in the device as wallpaper for the Home screen.

On the Home screen, tap  → **Set wallpaper** → **Home screen**, and then select one of the following:

- **Gallery:** See photos taken by the device's camera or images downloaded from the Internet.
- **Live wallpapers:** See animated images.
- **Wallpapers:** See wallpaper images.

Then, select an image and tap **Set wallpaper**. Or, select an image, resize it by dragging the frame, and then tap **Done**.

Using widgets

Widgets are small applications that provide convenient functions and information on your Home screen. To use them, add widgets from the widgets panel to the Home screen.



- Some widgets connect to web services. Using a web-based widget may result in additional charges.
- The widgets available may vary depending on the region or service provider.

Adding widgets to the Home screen

On the Home screen, tap  → **Widgets**. Scroll left or right on the widgets panel, and then tap and hold a widget to add it to the Home screen.

Using the setting shortcut widget

On the Home screen, tap  → **Widgets**, and then tap and hold **Settings Shortcut** to open a list of setting options. Select a setting option to add it to the Home screen as a shortcut.

Locked screen

The locked screen prevents the device from unwanted operation when not in use and also allows you to add convenient widgets.

Locking and unlocking the device

Pressing the Power button turns off the screen and puts the device into lock mode. The device automatically gets locked if it is not used for a specified period.

To unlock the device, press the Power button or the Home button and flick your finger in any direction within the unlock screen area at the right part of the screen.

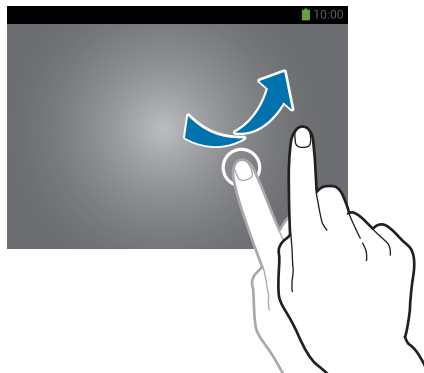

Adding widgets

To use widgets when the screen is locked, on the Applications screen, tap **Settings** → **Device** → **Lock screen**, and then tick **Multiple widgets**.

Tap the widgets panel area at the left part of the screen. Scroll left to the last page, tap , and then select a widget to add to the locked screen.

Rearranging panels

Moving a panel

Scroll left or right on the widgets panel area, tap and hold a panel preview, and then drag it to a new location.

Removing a panel

Scroll left or right on the widgets panel area, tap and hold a panel preview, and then drag it to the rubbish bin at the top of the screen.

Using applications

This device can run many different types of applications, ranging from media to Internet applications.

Opening an application

On the Home screen or the Applications screen, select an application icon to open it.

Opening from recently-used applications

Press and hold the Home button to open the list of recently-used applications.

Select an application icon to open.

Closing an application

Close applications not in use to save battery power and maintain device performance.

Press and hold the Home button, tap **Task manager**, and then tap **End** next to an application to close it. To close all running applications, tap **End all**. Alternatively, press and hold the Home button, and then tap **Close all**.

Applications screen

The Applications screen displays icons for all applications, including any new applications installed.

On the Home screen, tap  to open the Applications screen.

To view other panels, scroll left or right.

Rearranging applications

Tap  → **Edit**, tap and hold an application, and then drag it to a new location. To move it to another panel, drag it to the side of the screen.

Organising with folders

Put related applications together in a folder for convenience.

Tap  → **Edit**, tap and hold an application, and then drag it to **Create folder**. Enter a folder name and then tap **OK**. Put applications into the new folder by dragging, and then tap **Save** to save the arrangement.

Rearranging panels

Pinch on the screen, tap and hold a panel preview, and then drag it to a new location.

Installing applications

Use application stores, such as **Samsung Apps**, to download and install applications.

Uninstalling applications

Tap  → **Uninstall/disable apps**, and then select an application to uninstall it.



Default applications that come with the device cannot be uninstalled.

Help

Access help information to learn how to use the device and applications or configure important settings.

Tap **Help** on the Applications screen. Select a category to view tips.

To sort categories by an alphabetical order, tap .

To search for keywords, tap .

Entering text

Use the Samsung keyboard or the voice input feature to enter text.



Text entry is not supported in some languages. To enter text, you must change the input language to one of the supported languages.

Changing the keyboard type

Tap any text field, open the notifications panel, tap **Choose input method**, and then select the type of keyboard to use.

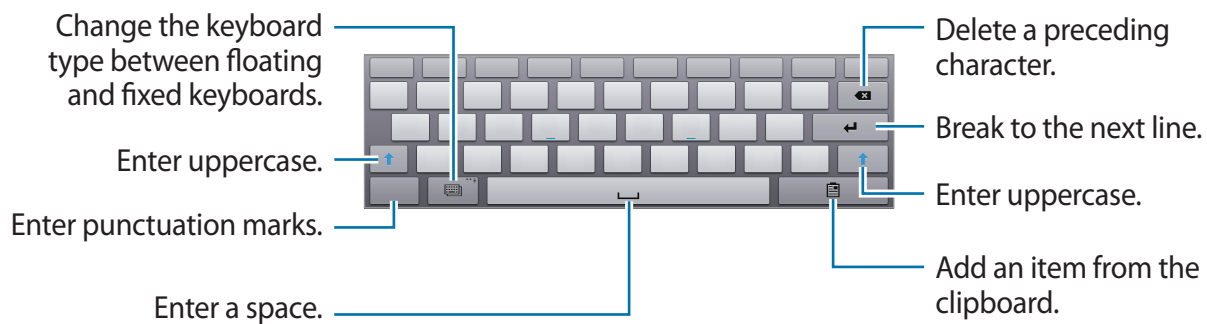

Entering uppercase

Tap  before entering a character. For all caps, tap it twice.



Changing the keyboard type

Tap  to change the keyboard type.

Changing language keyboards

Add languages to the keyboard, and then slide the space key left or right to change language keyboards.

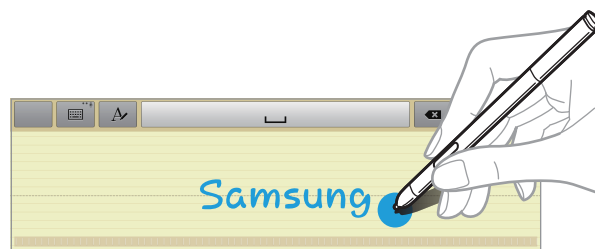

Handwriting

Tap and hold , tap , and then write a word with a finger or the S Pen. Suggested words appear as characters are entered. Select a suggested word.



Direct pen input

On the Applications screen, tap **Settings** → **Controls** → **S Pen** → **Direct pen input**, and then drag the **Direct pen input** switch to the right.

When hovering the S Pen over a text field,  icon appears at the upper left corner of the text field. Tap  to write with the S Pen. To make simple corrections, change input languages, or enter a space between characters, tap each correction tool displayed on the handwriting pad.

When this feature is enabled, you can do the following actions:

- Send a handwritten message.
- Set an alarm just by writing numbers.

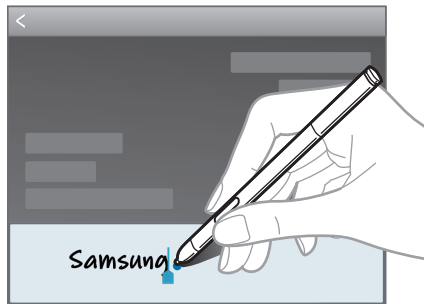



Entering text by voice

Activate the voice input feature and then speak into the microphone. The device displays what you speak.

If the device does not recognise your words, tap the underlined text and select an alternative word or phrase from the dropdown list.

To change the language or add languages for voice recognition, tap the current language.

Copying and pasting

Tap and hold over text, drag  or  to select more or less text, and then tap **Copy** to copy or **Cut** to cut. The selected text is copied to the clipboard.

To paste it into a text entry field, tap and hold at the point where it should be inserted, and then tap **Paste**.

Connecting to a Wi-Fi network

Connect the device to a Wi-Fi network to use the Internet or share media files with other devices. (p. 104)

Turning Wi-Fi on and off

Open the notifications panel, and then tap **Wi-Fi** to turn it on or off.



- Your device uses a non-harmonised frequency and is intended for use in all European countries. The WLAN can be operated in the EU without restriction indoors, but cannot be operated outdoors.
- Turn off Wi-Fi to save the battery when not in use.

Joining Wi-Fi networks

On the Applications screen, tap **Settings** → **Connections** → **Wi-Fi**, and then drag the **Wi-Fi** switch to the right.

Select a network from the list of detected Wi-Fi networks, enter a password if necessary, and then tap **Connect**. Networks that require a password appear with a lock icon. After the device connects to a Wi-Fi network, the device will automatically connect to it any time it is available.

Adding Wi-Fi networks

If the desired network does not appear in the networks list, tap **Add Wi-Fi network** at the bottom of the networks list. Enter the network name in **Network SSID**, select the security type and enter the password if it is not an open network, and then tap **Connect**.

Forgetting Wi-Fi networks

Any network that has ever been used, including the current network, can be forgotten so the device will not automatically connect to it. Select the network in the networks list, and then tap **Forget**.

Setting up accounts

Google applications, such as **Play Store**, require a Google account, and **Samsung Apps** requires a Samsung account. Create Google and Samsung accounts to have the best experience with the device.

Adding accounts

Follow the instructions that appear when opening a Google application without signing in to set up a Google account.

To sign in with or sign up for a Google account, on the Applications screen, tap **Settings** → **General** → **Accounts** → **Add account** → **Google**. After that, tap **New** to sign up, or tap **Existing**, and then follow on-screen instructions to complete the account setup. More than one Google account can be used on the device.

Set up a Samsung account as well.

Removing accounts

On the Applications screen, tap **Settings** → **General**, select an account name under **Accounts**, select the account to remove, and then tap **Remove account**.

Transferring files

Move audio, video, image, or other types of files from the device to the computer, or vice versa.



The following file formats are supported by some applications. Some file formats are not supported depending on the version of the device's software or the computer operating system.

- Music: mp3, m4a, 3ga, aac, ogg, oga, wav, wma, amr, awb, flac, midi, xmf, mxmf, imy, rtttl, rtx, and ota
- Image: bmp, gif, jpg, and png
- Video: avi, wmv, asf, flv, mkv, mp4, 3gp, and webm
- Document: doc, docx, xls, xlsx, ppt, pptx, pdf, and txt

Connecting with Samsung Kies

Samsung Kies is a computer application that manages media contents and personal information with Samsung devices. Download the latest Samsung Kies from the Samsung website.

- 1 Connect the device to the computer using the USB cable.
Samsung Kies launches on the computer automatically. If Samsung Kies does not launch, double-click the Samsung Kies icon on the computer.
- 2 Transfer files between your device and the computer.
Refer to the Samsung Kies help for more information.

Connecting with Windows Media Player

Ensure that Windows Media Player is installed on the computer.

- 1 Connect the device to the computer using the USB cable.
- 2 Open Windows Media Player and sync music files.

Connecting as a media device

- 1 Connect the device to the computer using the USB cable.
- 2 Open the notifications panel, and then tap **Connected as a media device** → **Media device (MTP)**.

Tap **Camera (PTP)** if your computer does not support Media Transfer Protocol (MTP) or not have any appropriate driver installed.

- 3 Transfer files between your device and the computer.

Securing the device

Prevent others from using or accessing personal data and information stored in the device by using the security features. The device requires an unlock code whenever unlocking it.

Setting a pattern

On the Applications screen, tap **Settings** → **Device** → **Lock screen** → **Screen lock** → **Pattern**.

Draw a pattern by connecting four dots or more, and then draw the pattern again to verify it. Set a backup unlock PIN to unlock the screen when you forget the pattern.

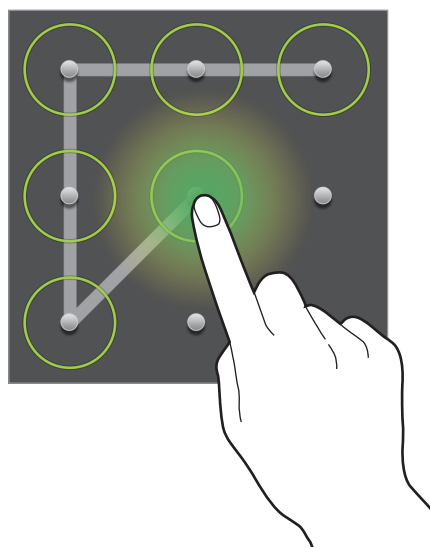

Setting a PIN

On the Applications screen, tap **Settings** → **Device** → **Lock screen** → **Screen lock** → **PIN**. Enter at least four numbers, and then enter the password again to verify it.

Setting a password

On the Applications screen, tap **Settings** → **Device** → **Lock screen** → **Screen lock** → **Password**.

Enter at least four characters including numbers and symbols, and then enter the password again to verify it.

Unlocking the device

Turn on the screen by pressing the Power button or the Home button, and enter the unlock code.



If the unlock code is forgotten, take the device to a Samsung Service Centre to reset it.

Upgrading the device

The device can be upgraded to the latest software.



This feature may not be available depending on the region or service provider.

Upgrading with Samsung Kies

Launch Samsung Kies and connect the device to the computer. Samsung Kies automatically recognises the device and shows available updates in a dialogue box, if any. Click the Update button in the dialogue box to start upgrading. Refer to the Samsung Kies help for details on how to upgrade.



- Do not turn off the computer or disconnect the USB cable while the device is upgrading.
- While upgrading the device, do not connect other media devices to the computer. Doing so may interfere with the update process.

Upgrading over the air

The device can be directly upgraded to the latest software by the firmware over-the-air (FOTA) service.

On the Applications screen, tap **Settings** → **General** → **About device** → **Software update** → **Update**.

Communication

Contacts

Use this application to manage contacts, including phone numbers, email addresses, and others.



Tap **Contacts** on the Applications screen.

Managing contacts

Tap **Contacts**.

Creating a contact

Tap  and enter contact information.

-  : Add an image.
-  /  : Add or delete a contact field.

Editing a contact

Select a contact to edit, and then tap .

Deleting a contact

Tap  → **Delete contacts**.



Searching for contacts

Tap **Contacts**.

Use one of the following search methods:

- Scroll up or down the contacts list.
- Use the index at the left side of the contacts list for quick scrolling, by dragging a finger along it.
- Tap the search field at the top of the contacts list and enter search criteria.

Once a contact is selected, take one of the following actions:

-  : Add to favourite contacts.
-  : Compose an email.

Displaying contacts

Tap **Contacts**.

By default, the device shows all saved contacts.

Tap  → **Contacts to display**, and then select a location where contacts are saved.

Moving contacts

Tap **Contacts**.

Moving contacts to Google

Tap  → **Merge accounts** → **Merge with Google**.

Contacts moved to Google Contacts appear with  in the contacts list.

Moving contacts to Samsung

Tap  → **Merge accounts** → **Merge with Samsung**.

Contacts moved to Samsung Contacts appear with  in the contacts list.

Importing and exporting contacts

Tap **Contacts**.

Importing contacts

Tap  → **Import/Export** → **Import from USB storage** or **Import from SD card**.

Exporting contacts

Tap  → **Import/Export** → **Export to USB storage** or **Export to SD card**.

Sharing contacts

Tap  → **Share namecard via**, select contacts, tap **Done**, and then select a sharing method.

Favourite contacts

Tap **Favourites**.

Tap , and then take one of the following actions:

- **Search:** Search for contacts.
- **Add to favourites:** Add contacts to favourites.
- **Remove from favourites:** Remove contacts from favourites.
- **Grid view / List view:** View contacts in grid or list form.
- **Help:** Access help information about using contacts.

Contact groups

Tap **Groups**.

Adding contacts to a group

Select a group, and then tap . Select contacts to add, and then tap **Done**.

Managing groups

Tap , and then take one of the following actions:

- **Search:** Search for contacts.
- **Edit:** Change the group settings.
- **Create:** Make a new group.
- **Remove member:** Remove members from the group.
- **Send email:** Send an email to a group's members.
- **Change order:** Tap and hold  next to the group name, drag it up or down to another position, and then tap **Done**.
- **Help:** Access help information about using contacts.

Sending an email to a group's members

Select a group, tap  → **Send email**, select members, and then tap **Done**.

Business card

Tap **Contacts**.

Create a business card and send it to others.

Tap **Set up my profile**, enter details, such as phone number, email address, and postal address, and then tap **Save**. If user information has been saved when you set up the device, select the business card in **ME**, and then tap  to edit.

Tap  → **Share namecard via**, and then select a sharing method.

Email

Use this application to send or view email messages.

Tap **Email** on the Applications screen.

Setting up email accounts

Set up an email account when opening **Email** for the first time.

Enter the email address and password. Tap **Next** for a private email account, such as Google Mail, or tap **Manual setup** for a company email account. After that, follow on-screen instructions to complete the setup.



To set up another email account, tap  → **Settings** → **Add account**.

Sending messages

Tap the email account to use, and then tap  at the top of the screen. Enter recipients, subject, and message, and then tap **Send**.

Tap  to add a recipient from the contacts list.

Tap  to attach images, videos, contacts, memos, events, and others.

Tap  →  to insert images, events, contacts, location information, and others into the message.

Sending scheduled messages

While composing a message, tap  → **Schedule sending**, set a time and date, and then tap **Done**. The device will send the message at the specified time and date.



- If the device is turned off at the scheduled time, is not connected to the network, or the network is unstable, the message will not be sent.
- This feature is based on the time and date set on the device. The time and date may be incorrect if you move across time zones and the network does not update the information.

Reading messages

Select an email account to use, and new messages are retrieved. To manually retrieve new messages, tap .

Tap a message to read.

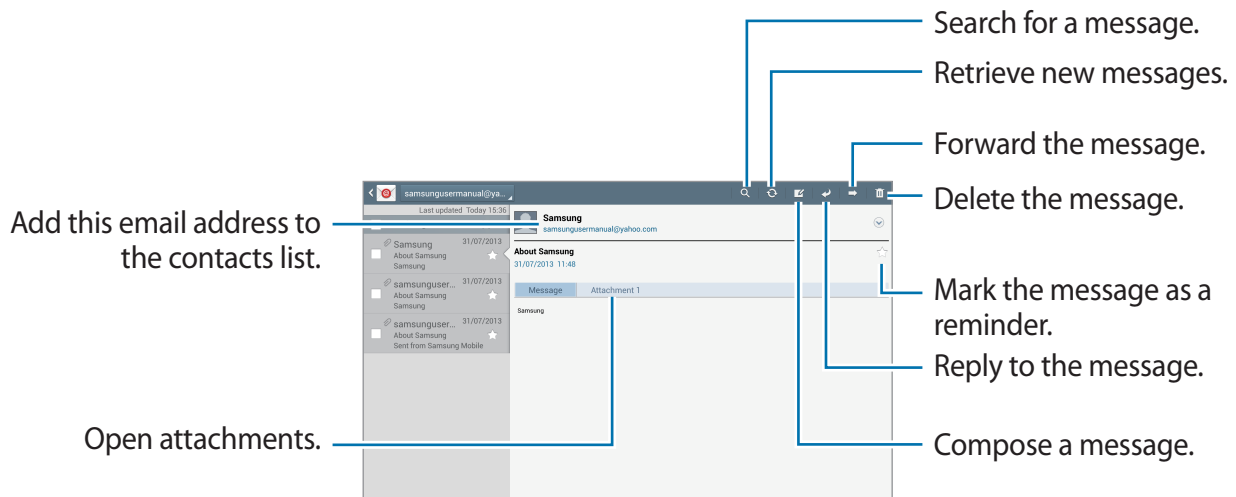

Tap the attachment tab to open attachments, and then tap **Save** to save it.

Google Mail

Use this application to quickly and directly access the Google Mail service.

Tap **Google Mail** on the Applications screen.



- This application may not be available depending on the region or service provider.
- This application may be labelled differently depending on the region or service provider.

Sending messages

In any mailbox, tap , enter recipients, a subject, and a message, and then tap **Send**.

Tap **+CC/BCC** to add more recipients.

Tap  to attach images.

Tap  → **Save draft** to save the message for later delivery.

Tap  → **Attach video** to attach videos.

Tap  → **Discard** to start over.

Tap  → **Settings** to change the Google Mail settings.

Tap  → **Send feedback** to report your opinion for application development.

Tap  → **Help** to access help information for the Google Mail.

Reading messages

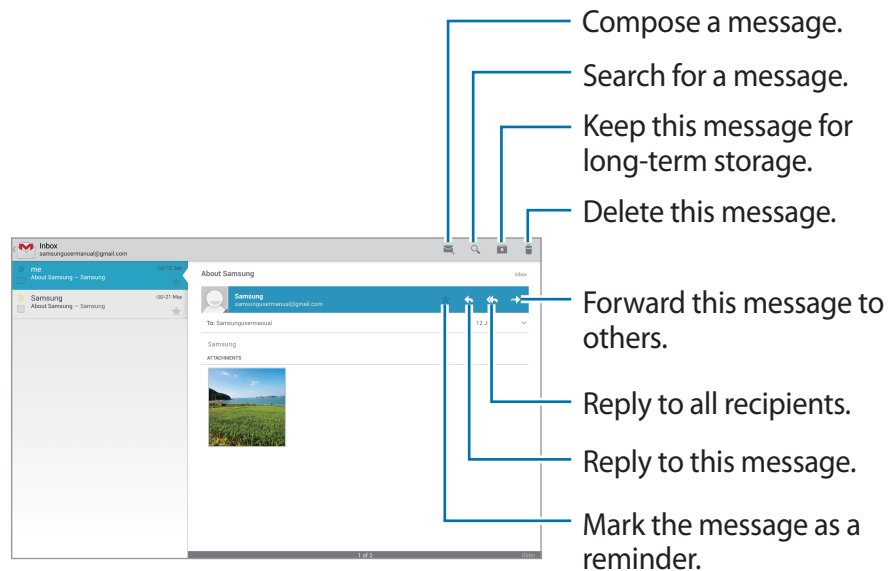

Labels

Google Mail does not use actual folders, but uses labels instead. When Google Mail is launched, it displays messages labelled Inbox.

To add a label to a message, select the message, tap  → **Change labels**, and then select the label to assign.

Hangouts

Use this application to chat with others.

Tap **Hangouts** on the Applications screen.



This application may not be available depending on the region or service provider.

Select a friend from the friends list or enter data to search and select a friend from the results to start chatting.

Google+

Use this application to stay connected with people via Google's social network service.

Tap **Google+** on the Applications screen.



This application may not be available depending on the region or service provider.

Tap **All** to change the category, and then scroll up or down to view posts from your circles.

Tap  to use other social network features.

ChatON

Use this application to chat with any device. To use this application, you must sign in to your Samsung account or verify your phone number.

Tap **ChatON** on the Applications screen.



This application may not be available depending on the region or service provider.

Create a buddies list by entering phone numbers or Samsung account email addresses, or by selecting buddies from the list of suggestions. Alternatively, tap → ☰ → **Contact sync** to manually sync contacts from the device.

Tap  → **Start chat** and select a buddy to start chatting.

To switch to voice or video chat, tap ☰ → **ChatON Voice Chat** or **ChatON Video Chat**.



Video chatting with dual camera mode will be provided for up to 3 minutes. After 3 minutes the device will turn off the rear camera for optimal performance.

Twitter

Use this application to access the Twitter social network site and keep in touch with people.

Tap **Twitter** on the Applications screen.



This application may not be available depending on the region or service provider.

Web & network

Internet

Use this application to browse the Internet.

Tap **Internet** on the Applications screen.

Viewing webpages

Tap the address field, enter the web address, and then tap **Go**.

Tap  to share or print the current webpage while viewing a webpage.

To change the search engine, tap the address field, and then tap the search engine icon next to the web address.

Opening a new page

Tap .

To go to another webpage, scroll left or right on the title field, and tap the title to select it.

Searching the web by voice



Tap the address field, tap , speak a keyword, and then select one of the suggested keywords that appear.

Bookmarks

To bookmark the current webpage, tap .

To open a bookmarked webpage, tap , and then select one.

History

Tap  → **History** to open a webpage from the list of recently-visited webpages. To clear the history, tap  → **Clear history**.

Links

Tap and hold a link on the webpage to open it in a new page, save, or copy.

To view saved links, use **Downloads**. (p. 101)

Sharing webpages

To share a webpage address with others, tap  → **Share via**.

To share a part of a webpage, tap and hold the desired text, and then tap **Share**.

Chrome

Use this application to search for information and browse webpages.

Tap **Chrome** on the Applications screen.



This application may not be available depending on the region or service provider.

Viewing webpages

Tap the address field, and then enter a web address or search criteria.

Opening a new page

Tap  → **New tab**.

To go to another webpage, scroll left or right on the title field, and tap the title to select it.

Bookmarks

To bookmark the current webpage, tap  , enter details, such as name and web address, and then tap **Save**.

To open a bookmarked webpage, tap  → **Bookmarks**, and then select one.

Searching the web by voice

Tap , speak a keyword, and then select one of the suggested keywords that appear.

Syncing with other devices

Sync open tabs and bookmarks to use with Chrome on another device, when you are logged in with the same Google account.

To view open tabs on other devices, tap  → **Other devices**. Select a webpage to open.

Bluetooth

Bluetooth creates a direct wireless connection between two devices over short distances. Use Bluetooth to exchange data or media files with other devices.



- Samsung is not responsible for the loss, interception, or misuse of data sent or received via the Bluetooth feature.
- Always ensure that you share and receive data with devices that are trusted and properly secured. If there are obstacles between the devices, the operating distance may be reduced.
- Some devices, especially those that are not tested or approved by the Bluetooth SIG, may be incompatible with your device.
- Do not use the Bluetooth feature for illegal purposes (for example, pirating copies of files or illegally tapping communications for commercial purposes).
Samsung is not responsible for the repercussion of illegal use of the Bluetooth feature.

To activate Bluetooth, on the Applications screen, tap **Settings** → **Connections** → **Bluetooth**, and then drag the **Bluetooth** switch to the right.

Pairing with other Bluetooth devices

On the Applications screen, tap **Settings** → **Connections** → **Bluetooth** → **Scan**, and detected devices are listed. Select the device you want to pair with, and then accept the auto-generated passkey on both devices to confirm.

Sending and receiving data

Many applications support data transfer via Bluetooth. An example is **Gallery**. Open **Gallery**, select an image, tap  → **Bluetooth**, and then select one of the Bluetooth devices. After that, accept the Bluetooth authorisation request on the other device to receive the image. The transferred file is saved in the **Bluetooth** folder. If a contact is received, it is added to the contacts list automatically.

Screen Mirroring

Use this feature to connect your device to a large screen with an AllShare Cast dongle or HomeSync and then share your contents. You can also use this feature with other devices that support the Wi-Fi Miracast feature.



- This feature may not be available depending on the region or service provider.
- Miracast-enabled devices that do not support High-bandwidth Digital Content Protection (HDCP) may not be compatible with this feature.
- Some files may be buffered during playback, depending on the network connection.
- To save energy, deactivate this feature when not in use.
- If you specify a Wi-Fi frequency, AllShare Cast dongles or HomeSync may not be discovered or connected.
- If you play videos or games on a TV, select an appropriate TV mode to get the best experience.

On the Applications screen, tap **Settings** → **Connections** → **Screen Mirroring**, and then drag the **Screen Mirroring** switch to the right. Select a device, open or play a file, and then control the display with the keys on your device. To connect to a device using a PIN, tap and hold the device name to enter the PIN.

Samsung Link

Use this application to play contents saved on remotely located devices or web storage services over the Internet. You can play and send multimedia files on your device to another device or web storage service.

Tap **Samsung Link** on the Applications screen.

To start **Samsung Link**, you need to download and install the application. Tap **Install**, and then follow the on-screen instructions.



This application may not be available depending on the region or service provider.

Group Play

Use this application to enjoy moments with your friends by sharing and playing content. Create or join a Group Play session, and then share content, such as images or music.

Tap **Group Play** on the Applications screen.

To start **Group Play**, you need to download and install the application. Tap **Install**, and then follow the on-screen instructions.



- This application may not be available depending on the region or service provider.
- While using this application, you cannot access the Internet.

WatchON

Use this application to connect to a TV to watch your favourite shows and movies.

Tap **WatchON** on the Applications screen.

You must first connect the device to a network and ensure that the device's infrared port is facing the TV.

Connecting to a TV

Connect to a TV to display the device's screen onto a large surface and control the TV remotely with the device.

Select a country, region, and broadcast service. Tap  → **Setup**, select the TV brand, and then follow on-screen instructions to register the TV with the device. The steps vary depending on the options you choose.

To connect to other devices, tap  → **Settings** → **Room settings** → **Add room**.

Watching TV

Select from the TV programme suggestions based on your choice when registering a TV or select a category at the bottom of the screen. Select a TV programme or a movie, and then tap **Watch on TV**, **Watch this channel**, or **Watch now**. The selected programme will show up on the connected TV.

Tap  and open the control panel to control the TV.

Setting programme reminders

Tap **Timeline** at the bottom of the screen and select a time for a TV programme you want to watch. Select a programme, and then tap .

The reminder for the selected programme is added to **S Planner**.

Media

Music

Use this application to listen to music.

Tap **Music** on the Applications screen.



- Some file formats are not supported depending on the software installed on the device.
- Some files may not play properly depending on the encoding method used.

Playing music

Select a music category, and then select a song to play.

Tap the album image at the bottom of the screen to open the music player screen.

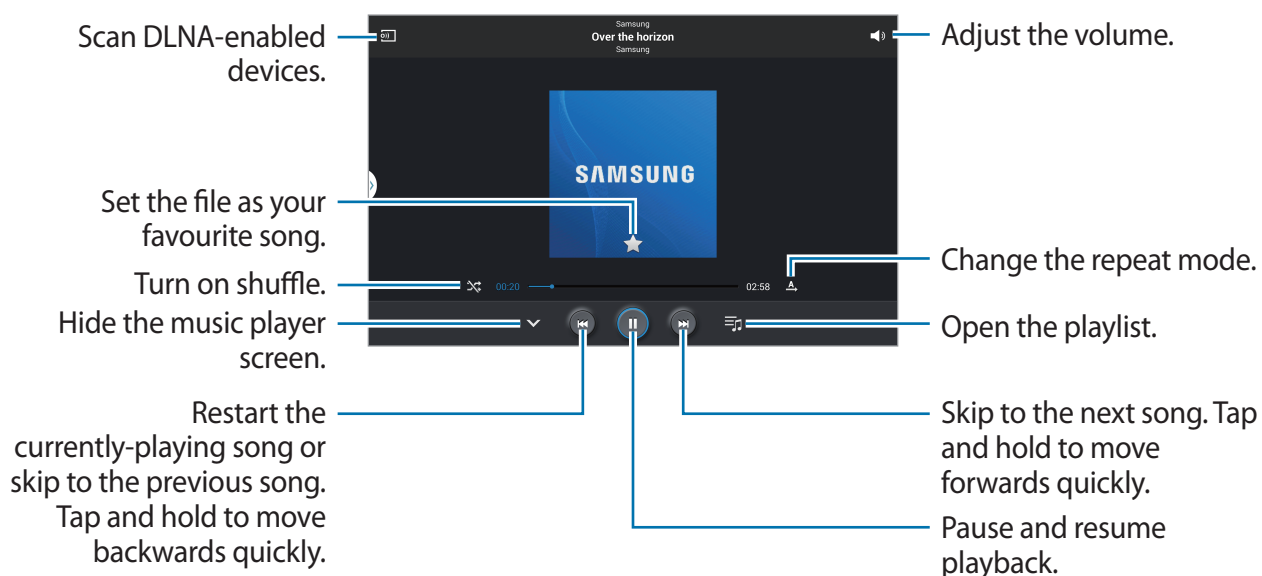

To listen to songs at equal volume levels, tap  → **Settings** → **Advanced** → **Smart volume**.



Smart volume may not be activated for some files.



When **Smart volume** is activated, the volume may end up louder than the device volume level. Use caution to avoid long-term exposure to loud sounds to prevent damage to your hearing.

To set a personalised sound while listening to songs with a headset, tap  → **Settings** → **Advanced** → **Adapt Sound** → **On**. When you turn the volume up to level 14 or higher, the adapt sound option is not applied to music playback. If you turn the volume down to level 13 or lower, the option is reapplied.

Setting a song as alarm tone

To use the currently-playing song as alarm tone, tap  → **Set as alarm tone**, and select an option.

Creating playlists

Make an own selection of songs.

Tap  → **Create playlist**. Enter a title and tap **OK**. Select songs to include, and then tap **Done**.

To add the currently-playing song to a playlist, tap  → **Add to playlist**.

Playing music by mood

Play music grouped by mood. The playlist is automatically created by the device. When a new song is added, tap **Music square** → .

Tap **Music square**, and select a cell of mood. Or select multiple cells by dragging your finger.

Camera

Use this application to take photos or videos.

Use **Gallery** to view photos and videos taken with the device's camera. (p. 71)

Tap **Camera** on the Applications screen.



- The camera automatically shuts off when unused.
- Make sure that the lens is clean. Otherwise, the device may not work properly in some modes that require high resolutions.

Camera etiquette

- Do not take photos or videos of other people without their permission.
- Do not take photos or videos where legally prohibited.
- Do not take photos or videos in places where you may violate other people's privacy.

Taking photos

Taking a photo

Tap the image on the preview screen where the camera should focus. When the subject is in focus, the focus frame turns green. Tap  to take the photo.



Shooting mode

Several photo effects are available.

Tap **MODE**, and then scroll up or down the screen at the right side of the screen.

- **Auto:** Use this to allow the camera to evaluate the surroundings and determine the ideal mode for the photo.
- **Beauty face:** Take a photo with lightened faces for gentler images.
- **Best photo:** Take a series of photos, and then save the best one.
- **Best face:** Use this to take multiple group shots at the same time and combine them to create the best possible image.

Tap  to take multiple photos. To get the best shot, hold the camera steady and remain still while taking photos. When **Gallery** opens, tap the yellow frame on each face, and choose the best individual pose for the subject. After choosing a pose for each individual, tap **Save** to merge the images into a single photo, and save it.

- **Sound & shot:** Use this to take a photo with sound.

Tap  to take a photo. The device records a few seconds of audio after taking a photo.



While taking photos in this mode, sound is recorded by the internal microphone.

- **Drama:** Use this to take a series of photos and combine them to create an image that shows trails of the movement.

To get the best shot, follow these tips. The device may not take photos properly in other shooting conditions.

- Hold the camera steady and remain still while taking photos.
- Take photos of a subject that is moving in one direction.
- Take photos with backgrounds that are free of moving objects.
- Avoid taking photos of a subject and background with similar colours.
- Avoid taking photos of a subject that is too close or too far away to fit within the viewfinder or that is too long such as a bus or a train.

- **Rich tone (HDR):** Use this to take a photo with an improved contrast ratio.
- **Eraser:** Use this to erase the movements of moving subjects in the background.

Tap  to take a series of photos. The device erases traces of movement from a moving subject. To restore the original photo, tap **Show moving objects**, and then tap the highlighted area.

To get the best shot, follow these tips.

- Hold the camera steady and remain still while taking photos.
- Avoid taking photos of a subject and background with similar colours.
- When taking photos of a subject that is moving very little or moving a great deal, the camera may not recognise all of the movements.
- If there are multiple subjects moving in the background, the camera may not recognise all of the movement.

- **Panorama:** Take a photo composed of many photos strung together.

To get the best shot, follow these tips.



- Move the camera slowly in one direction.
- Keep the camera's viewfinder within the guide frame.
- Avoid taking photos of a subject in front of unrecognisable backgrounds, such as empty skies or plain walls.

- **Sports:** Use this setting for fast-moving subjects.
- **Night:** Use this setting for images taken in darker conditions.

Panoramic photos

A panoramic photo is a wide landscape image consisting of multiple shots.

Tap **MODE** → **Panorama**.

Tap  and move the camera in one direction. When the blue frame aligns with the viewfinder, the camera automatically takes another shot in a panoramic sequence. To stop shooting, tap .

If the viewfinder is out of the direction, the device stops shooting.

Applying filter effects

Use the filter effects to take unique photos or videos.

Tap  and select a filter effect. The available options vary by mode.

Taking videos



Taking a video

Tap  to take a video. To pause recording, tap . To stop recording, tap .

Press the Shutter button to take photos while taking a video.



While recording, use the following actions:

- To change the focus, tap where you want to focus. To focus on the centre of the screen, tap .
- To capture an image from the video while recording, tap .

Recording mode

Tap  →  to change the recording mode.

- **Normal:** Use this mode for normal quality.
- **Limit for email:** Use this mode to lower quality for sending via email.
- **Fast motion:** Use this mode to take a video of a moving subject. The device will play the video in fast motion.

Zooming in and out

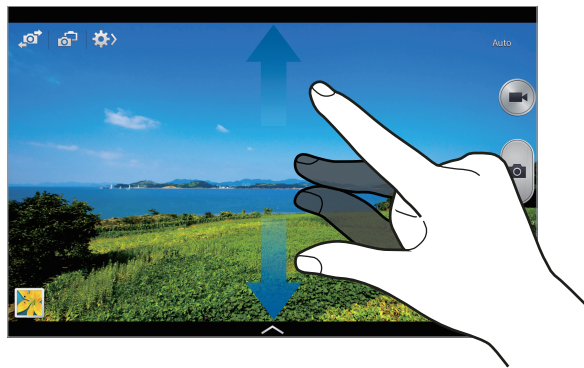

Use one of the following methods:

- Use the Volume button to zoom in or out.
- Spread two fingers apart on the screen to zoom in, and pinch to zoom out.



The zoom in/out effect is available when using the zoom feature while shooting video.

Dual Camera mode

When you take a landscape photo with the rear camera, the photo or video captured by the front camera appears in an inset window, or vice versa. Use this feature to take a beautiful landscape photo and a self-portrait simultaneously.

Tap  to switch to dual camera mode. Tap  to take a photo or tap  to take a video.

Tap to resize it or move the location.



Select among various styles that are available.



- You can record videos in dual camera mode for up to 5 minutes in Full HD and up to 10 minutes in HD.
- While taking videos in this mode, sound is recorded by the internal microphone.



Share shot

Tap  → , and then select one of the following:



- **Share shot:** Send a photo directly to another device via Wi-Fi Direct.
- **Buddy photo share:** Set the device to recognise a person's face that you have tagged in a photo and send it to that person.
- **ChatON photo share:** Send a photo to another device via ChatON.
- **Remote viewfinder:** Set a device to control the camera remotely.

Controlling the camera remotely

Set a device as a viewfinder to control the camera remotely.

Tap  →  → **Remote viewfinder**, and then connect the device and the camera using Wi-Fi Direct. Tap  to take a photo remotely using the device as a viewfinder.

Configuring settings for Camera

Tap  →  to configure settings for Camera. Not all of the following options are available in both still camera and video camera modes. The available options vary depending on the mode used.

- **Photo size / Video size:** Select a resolution. Use higher resolution for higher quality. But it takes up more memory.
- **Burst shot:** Take a series of photos of moving subjects.
- **Tap to take pics:** Tap the image on the preview screen to take photos.
- **Face detection:** Set the device to recognise people's faces and help you take photos of them.

- **Metering:** Select a metering method. This determines how light values are calculated. **Centre-weighted** measures background light in the centre of the scene. **Spot** measures the light value at a specific location. **Matrix** averages the entire scene.
- **ISO:** Select an ISO value. This controls camera light sensitivity. It is measured in film-camera equivalents. Low values are for stationary or brightly-lit objects. Higher values are for fast-moving or poorly-lit objects.
- **Video stabilisation:** Activate or deactivate anti-shake. Anti-shake helps focus when the camera is moving.
- **Auto night detection:** Set the device to automatically detect darker conditions and adjust the brightness of the photo without the flash.
- **Save as:** Set the device to delete the original photo when taking photos with rich tone mode.
- **Location tag:** Attach a GPS location tag to the photo. Activate this feature when taking photos to create albums in **Story Album**.



- To improve GPS signals, avoid shooting in locations where the signal may be obstructed, such as between buildings or in low-lying areas, or in poor weather conditions.
- Your location may appear on your photos when you upload them to the Internet. To avoid this, deactivate the GPS tag setting.
- **Review:** Briefly display photos taken.
- **Volume key:** Set the device to use the Volume button to control the shutter or zoom function.
- **Timer:** Use this for delayed-time shots.
- **White balance:** Select an appropriate white balance, so images have a true-to-life colour range. The settings are designed for specific lighting situations. These settings are similar to the heat range for white-balance exposure in professional cameras.
- **Exposure value:** Change the exposure value. This determines how much light the camera's sensor receives. For low-light situations, use a higher exposure.
- **Guidelines:** Display viewfinder guides to help composition when selecting subjects.

- **Flash:** Activate or deactivate the flash.
- **Voice control:** Set the camera to take photos with voice commands.
- **Contextual filename:** Set the camera to display contextual tags. Activate this to use Tag Buddy in **Gallery** and **Story Album**.
- **Save as flipped:** Invert the image to create a mirror-image of the original scene.
- **Storage:** Select the memory location for storage.
- **Reset:** Reset the camera settings.

Shortcuts

Reorganise shortcuts for easy access to the camera's various options.

Tap  → **Edit quick settings**.

Tap and hold an option and drag it to a slot at the top of the screen. The other icons can be moved within the list by tapping and dragging them.

Gallery

Use this application to view images and videos.

Tap **Gallery** on the Applications screen.



- Some file formats are not supported depending on the software installed on the device.
- Some files may not play properly depending on the encoding method used.

Viewing images

Launching **Gallery** displays images by creation date. When another application, such as **Email**, saves an image, the **Download** folder is automatically created to contain the image. Likewise, capturing a screenshot automatically creates the **Screenshots** folder. Select a folder to open it.

In a folder, images are displayed by creation date. Select an image to view it in full screen. Scroll left or right to view the next or previous image.

Zooming in and out

Use one of the following methods to zoom in an image:

- Double-tap anywhere to zoom in.
- Spread two fingers apart on any place to zoom in. Pinch to zoom out, or double-tap to return.

Viewing images using the motion feature

Use the motion feature to execute a function with particular motion.

On the Applications screen, tap **Settings** → **Controls** → **Motions**, drag the **Motions** switch to the right, and then turn on the switch for each feature.

To stop using a motion feature, drag the **Motions** switch to the left.

Playing videos

Video files show the  icon on the preview. Select a video to watch it and tap .

Trimming segments of a video

Select a video, and then tap . Move the start bracket to the desired starting point, move the end bracket to the desired ending point, and then save the video.

Editing images

When viewing an image, tap  and use the following functions:

- **Favourite:** Add to the favourites list.
- **Slideshow:** Start a slideshow with the images in the current folder.
- **Photo frame:** Use this to add a frame and a note to an image. The edited image is saved in the **Photo frame** folder.
- **Photo note:** Use this to write a note on the back of the image. Tap  to edit the note.
- **Copy to clipboard:** Copy to clipboard.

- **Print:** Print the image via a USB or Wi-Fi connection. Some printers may not be compatible with the device.
- **Rename:** Rename the file.
- **Buddy photo share:** Send the image to a person whose face is tagged in the image.
- **Rotate left:** Rotate anticlockwise.
- **Rotate right:** Rotate clockwise.
- **Crop:** Resize the blue frame to crop and save the image in it.
- **Set as:** Set the image as wallpaper or a contact image.
- **Details:** View image details.
- **Settings:** Change the Gallery settings.

Modifying images

When viewing an image, tap  and use the following functions:



- **Rotate:** Rotate the image.
- **Crop:** Crop the image.
- **Colour:** Adjust the saturation or brightness of the image.
- **Effect:** Apply effects to the image.
- **Sticker:** Attach stickers.
- **Drawing:** Draw on the image.
- **Frame:** Apply frames to the image.

Favourite images

When viewing an image, tap  → **Favourite** to add the image to the favourites list.



Deleting images

Use one of the following methods:

- In a folder, tap  → **Select item**, select images by ticking, and then tap .
- When viewing an image, tap .

Sharing images

Use one of the following methods:

- In a folder, tap  → **Select item**, select images by ticking, and then tap  to send them to others or share them via social network services.
- When viewing an image, tap  to send it to others or share it via social network services.

Setting as wallpaper

When viewing an image, tap  → **Set as** to set the image as wallpaper or to assign it to a contact.

Tagging faces

Tap  → **Settings** → **Tags**, and then tick **Face tag**. A yellow frame appears around the recognised face. Tap the face, tap **Add name**, and then select or add a contact.

When the face tag appears on an image, tap the face tag and use available options, such as sending messages.



Face recognition may fail depending on the face angle, face size, skin colour, facial expression, light conditions, or accessories the subject is wearing.

Using Tag buddy

Tap  → **Settings** → **Tags** → **Tag buddy**, and then drag the **Tag buddy** switch to the right to display a contextual tag (weather, location, date, and person's name) when opening an image.

Story Album

Use this application to create your own digital album to keep your stories by organising the images neatly and automatically.

Tap **Story Album** on the Applications screen.

To start **Story Album**, you need to download and install the application. Tap **Install**, and then follow the on-screen instruction.

Video

Use this application to play video files.

Tap **Video** on the Applications screen.



- Some file formats are not supported depending on the software installed on the device.
- Some files may not play properly depending on the encoding method used.

Playing videos

Select a video to play.

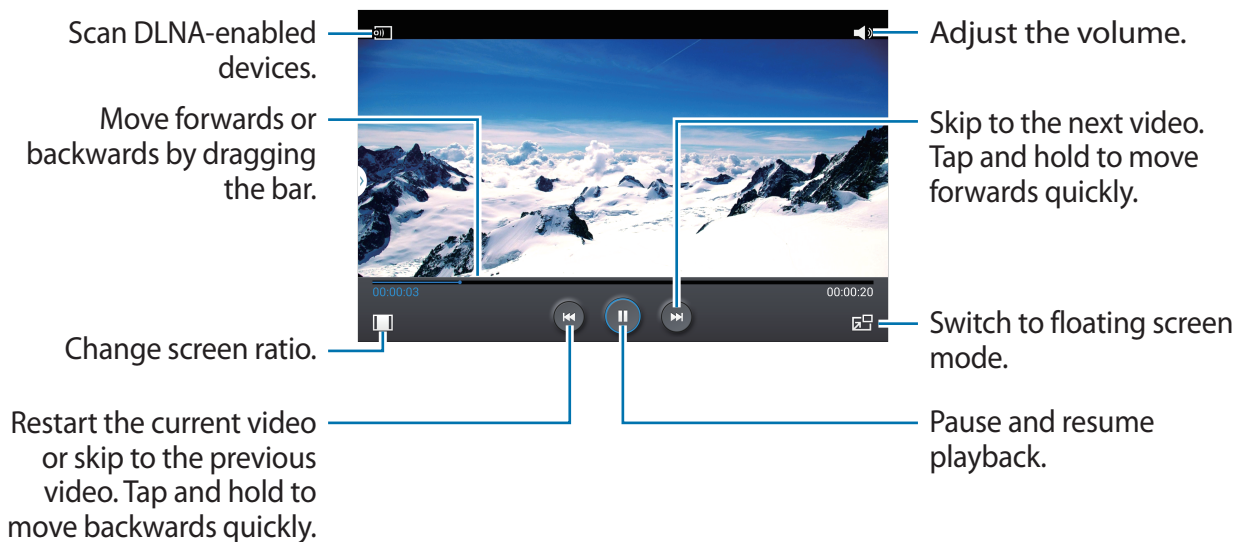

Deleting videos

Tap  → **Delete**, select videos by ticking, and then tap **Delete**.

Sharing videos

Tap  → **Share via**, select videos by ticking, tap **Done**, and then select a sharing method.

Using Popup Video player

Use this feature to use other applications without closing the video player. While watching videos, tap  to use the pop-up player.

Spread two fingers apart on the screen to enlarge the player or pinch to reduce it. To move the player, drag the player to another location.

Purchasing videos

Scroll the screen to the left or right, and then select a video.

Video Editor

Use this application to edit videos and apply various effects.

Tap **Video Editor** on the Applications screen.

To start **Video Editor**, you need to download and install the application. Tap **Install**, and then follow the on-screen instructions.



- Some video files in **Gallery** may not be viewable depending on video resolution and codec.
- Some files may not play properly depending on the encoding method used.

YouTube

Use this application to watch videos from the YouTube website.

Tap **YouTube** on the Applications screen.



This application may not be available depending on the region or service provider.

Watching videos

Tap , and then enter a keyword. Select one of the returned search results to watch a video.

Tap  to display full screen.



Sharing videos

Select the video to view, tap , and then select a sharing method.

Uploading videos

Select your account, tap , select a video, enter information for the video, and then tap **UPLOAD**.

My Magazine

Use this applications to make your own social magazine.

On the Home screen, flick your finger up from the bottom of the screen.









When running My magazine for the first time, tap **Next**, read and agree to the terms and conditions, and then tap **Start**.

To set up your magazine, tap , and then tick categories. Tap , select new topics, and then tap .

Flick left or right to change the category, flick up or down to turn over magazine pages, and then select an article to read.

While viewing a page, tap  to use the following application:

- : Launch S Note.
- : Launch S Planner.
- : Send an email.
- : Launch Google search.
- : Open the web browser.
- : Open the Applications screen.

While reading an article, use the following icons:

- : Go to the previous page.
- : Share the article with others.
- : Set the article as your likes in Facebook.
- : View others' comments about the article.
- : Set the article as your likes in Flipboard.
- : Add the article to your Flipboard magazine.

Flipboard

Use this application to access your personalised magazines.

Tap **Flipboard** on the Applications screen.







This application may not be available depending on the region or service provider.

To start your Flipboard, flick left on the greeting page, select news topics, and then tap **Build Your Flipboard**.

Select a cover story or a topic, flick through the Flipboard pages, and then select an article to read.

While reading an article, use the following icons:

-  : Go to the previous page.
-  : Share the article with others.
-  : Set the article as your likes in Flipboard.
-  : Add the article to your Flipboard magazine.

SketchBook for Galaxy

Use this application to create a quick concept or sketch out your idea for a project.

On the Applications screen, tap **SketchBook for Galaxy**.

Use artistic tools to draw and paint your digital art. The image is saved in **Gallery**.

To start **SketchBook for Galaxy**, you need to download and install the application. Tap **Install**, and then follow the on-screen instructions.



This application may not be available depending on the region or service provider.

Businessweek+

Use this application to get the latest news about finance, business, and more.

Tap **Businessweek+** on the Applications screen.



This application may not be available depending on the region or service provider.

NYTimes

Use this application to browse and navigate some articles and more.

Tap **NYTimes** on the Applications screen.



This application may not be available depending on the region or service provider.

To search for articles, tap , and then enter a keyword in the search field.

Application & media stores

Play Store

Use this application to purchase and download applications and games that are able to run on the device.

Tap **Play Store** on the Applications screen.



This application may not be available depending on the region or service provider.

Installing applications

Browse applications by category, or tap  to search with a keyword.

Select an application to view information. To download it, tap **Install**. If there is a charge for the application, tap the price, and follow on-screen instructions to complete the purchase process.



- When a new version is available for any installed application, an update icon appears at the top of the screen to alert you to the update. Open the notifications panel and tap the icon to update the application.
- To install applications that you downloaded from other sources, on the Applications screen, tap **Settings** → **General** → **Security** → **Unknown sources**.

Uninstalling applications

Uninstall the applications purchased from **Play Store**.

Tap , select an application to delete in the list of installed applications, and then tap **Uninstall**.

Samsung Hub

Use this application to purchase, enjoy, and manage digital media content. Samsung Hub also promotes and recommends content that you may like.

Tap **Samsung Hub** on the Applications screen.



The types of content provided may vary depending on the region or service provider.

Purchasing multimedia content

Select a service category, select media content, and then complete the purchase process.

Managing content on the device

Select a service category, scroll left, and then manage content on the device.

Samsung Apps

Use this application to purchase and download dedicated Samsung applications. For more information, visit www.samsungapps.com.

Tap **Samsung Apps** on the Applications screen.



This application may not be available depending on the region or service provider.

Installing applications

Browse applications by category. Tap **CATEGORY** to select a category.

To search for an application, tap  at the top of the screen, and then enter a keyword in the search field.

Select an application to view information. To download it, tap **Free**. If there is a charge for the application, tap the price, and follow on-screen instructions to complete the purchase process.

Play Books

Use this application to read and download book files.

Tap **Play Books** on the Applications screen.



This application may not be available depending on the region or service provider.

Play Movies

Use this application to watch, download, and rent movies or TV shows.

Tap **Play Movies** on the Applications screen.



This application may not be available depending on the region or service provider.

Play Music

Use this application to listen to music from the device or stream music from the Google cloud service.

Tap **Play Music** on the Applications screen.



This application may not be available depending on the region or service provider.

Play Games

Use this application to download and play games.

Tap **Play Games** on the Applications screen.



This application may not be available depending on the region or service provider.

Utilities

S Note

Use this application to create a note using multimedia files or voice recordings.



Tap **S Note** on the Applications screen.

Creating notes

When running S Note for the first time, tap **Start** to set the default covers and a template. Follow the on-screen instruction to complete the setup.

Composing notes

Create notes with enriched content by drawing sketches with your finger or S Pen, or by adding multimedia files or voice memos.

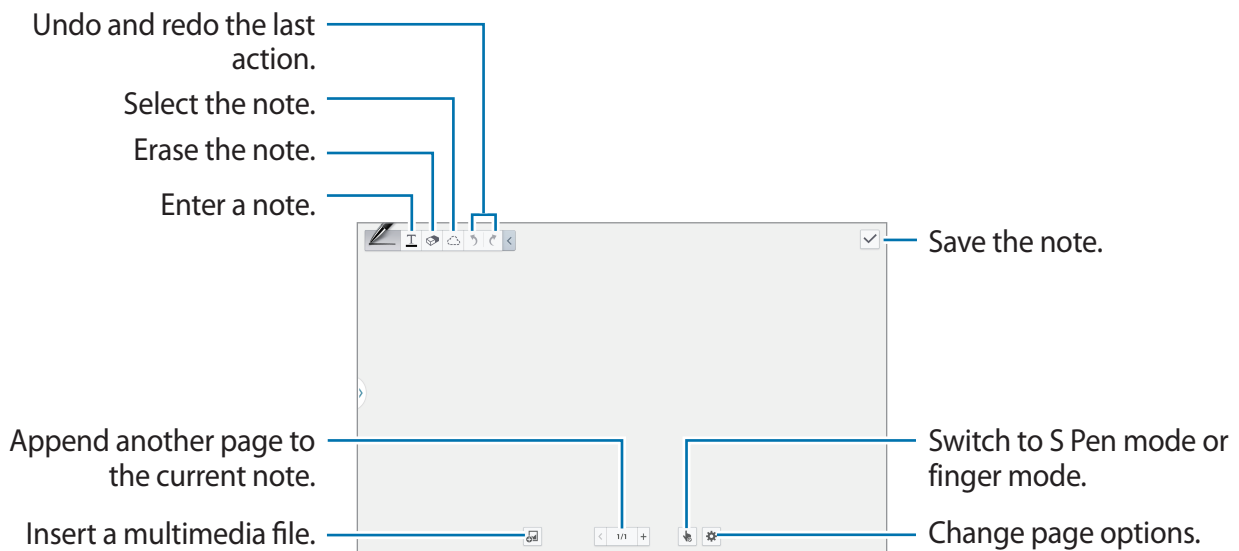

Tap  to write or draw on the screen, or tap  to enter text with the keyboard.



When using the templates that have image frames, tap and hold an image frame, and then tap **Images** or **Take picture** to add an image.

To delete a frame, tap and hold the frame, and then tap **Delete**.

When jotting down a note, tap  once more to change the pen type, line thickness, or pen colour.

When erasing the handwritten note, tap , and then tap  to change the eraser size or tap **Clear all** to clear the note.

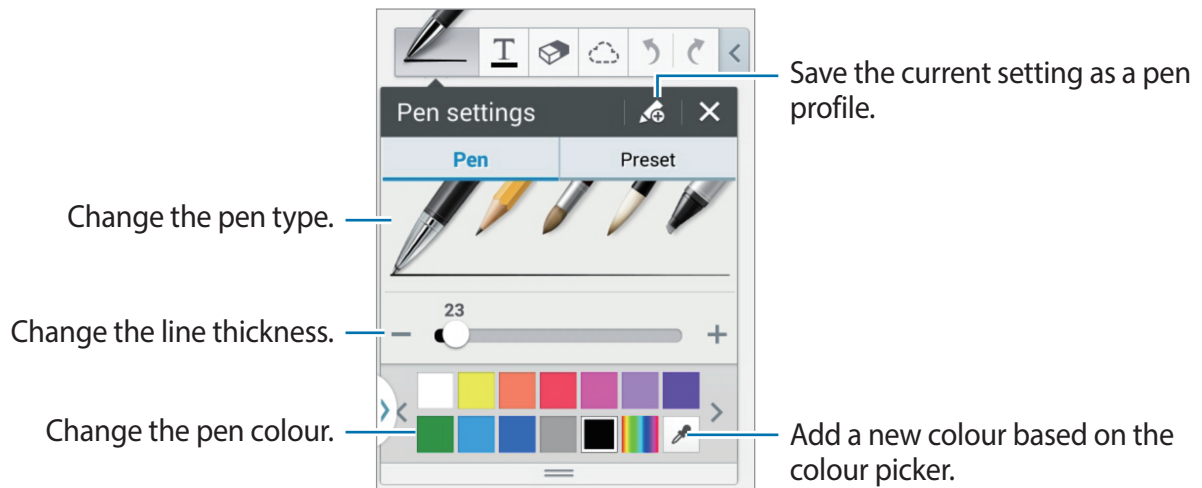

To zoom in or out the screen, spread two fingers apart or pinch them.

To add a new page, tap  → **Add page**.

To delete the page, tap  → **Delete page**.

To add a tag to the page, tap  → **Add tag**.

To add an index to the page, tap  → **Index page**.

To change the page template, tap  → **Add template**.

To change the background of the page, tap  → **Background**.

To display a grid on the page, tap  → **Show grid**.

Using the selection tool

Write a formula or draw a shape, and then tap . Draw a line around the formula or the shape to select it, and then tap **Transform into** → **Shape** or **Formula** to organise it.

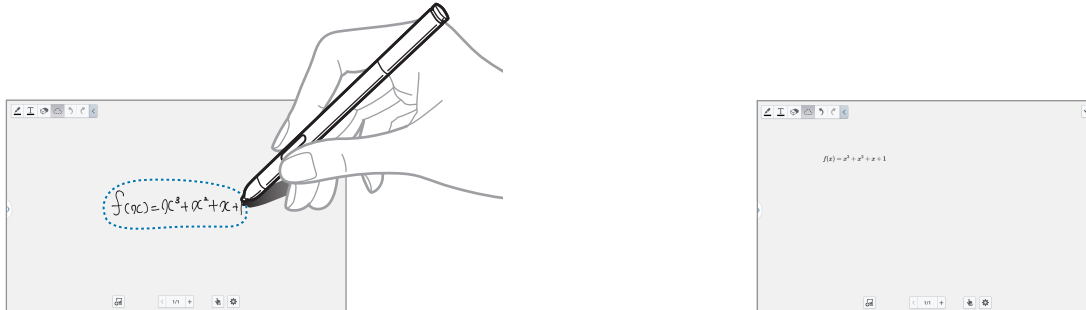



Inserting multimedia files

Tap  to insert images, videos, voice memos, and more.

Making a table

Tap  → **Easy chart** → **Table**, set the number of rows and columns for the table, and then tap **Done**.

- To enter data in the table, tap a table cell.
- To add or delete columns, tap  → **Add dataset** or **Delete dataset**.
- To add or delete rows, tap  → **Add item** or **Delete item**.



Making a chart

To make a chart, tap  → **Easy chart**, and then select a chart type. Then, draw bars, lines, or dividers on the chart.

To make a chart from the data in the table, tap and hold the table, tap **Edit chart** → , and then select a chart.

Editing a chart

To edit a chart, tap the chart or table → **Edit chart**, and then use the following options:

- Tap  at the top left of the screen to change the chart type.
- Tap an item, and tap , and then write values, to correct with your finger or the S Pen.



The available options may vary depending on the chart type.

Using idea sketch

Tap  → **Idea Sketch**, and then write a keyword or select category to search for images.

To add your own sketches to the list, tap , and then draw an image in the sketch panel.

Viewing note pages

When viewing pages, tap  to use the following options:

- **Delete:** Delete the page.
- **Share via:** Send the page to others.
- **Export:** Save the page as an image file or a PDF file.
- **Edit pages:** Add or delete pages.
- **Add tag:** Add a tag to the page.
- **Index page:** Add an index to the page.
- **Add shortcut to home:** Add a shortcut to the page on the Home screen.
- **Print:** Print the page via a USB or Wi-Fi connection. Some printers may not be compatible with the device.
- **Save as:** Save the page with a different name.
- **Set as:** Set the note as wallpaper or assign it to a contact.

Viewing pages preview

Drag down a note to preview the pages above the note.

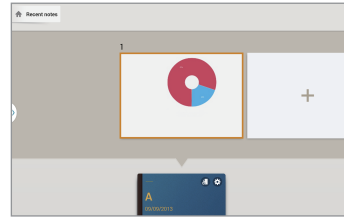
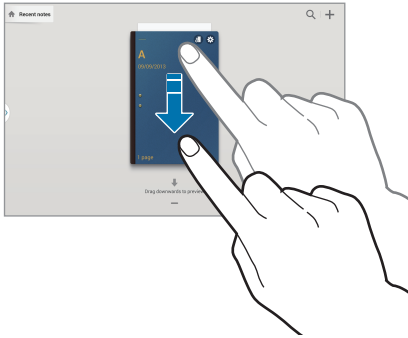

Tap  on the note cover to access the following options:

- **Delete:** Delete the note.
- **Share via:** Share the note with others.
- **Export:** Export the note as an image file or a PDF file.
- **Rename:** Rename the note.
- **Edit cover:** Change the note cover.
- **Add to favourites:** Add the note to the favourites list.
- **Lock:** Lock the note so that others cannot view it.
- **Add shortcut to home:** Add a shortcut to the note on the Home screen.

Searching for notes

Use this feature to search for a note by entering search criteria, such as names, tags, text, or handwritten words.

Tap , tap the search field at the top of the screen, and then enter search criteria.

S Planner

Use this application to manage events and tasks.

Tap **S Planner** on the Applications screen.

Creating events or tasks

Tap **+**, and then use one of the following methods:

- **Add event:** Enter an event with an optional repeat setting.
- **Add task:** Enter a task with an optional priority setting.

To add an event or task more briefly, tap a date to select it and tap it again.

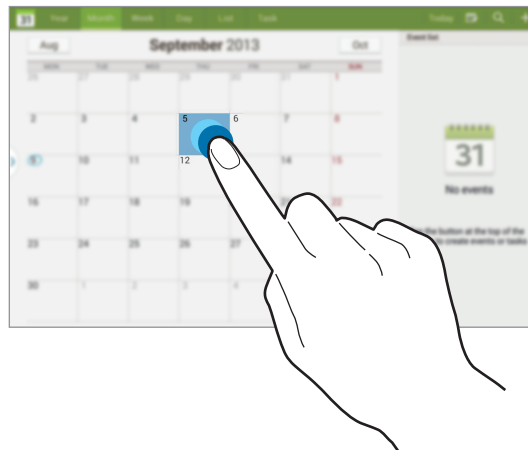

Enter a title and specify which calendar to use or sync with. Then tap **Edit event details** or **Edit task details** to add more details, such as how often the event repeats, when it has an advance alert, or where it takes place.

Invite others to the event by sending an email. Enter the email address to the **Participants** field, or tap **👤** to open the contacts list.

Attach a map showing the location of the event. Enter the location in the **Location** field, tap **📍** next to the field, and then pinpoint the precise location by tapping and holding on the map that appears.

Syncing with Google Calendar

On the Applications screen, tap **Settings** → **General** → **Accounts** → **Google** under **My accounts**, select the Google account, and then tick **Sync Calendar**.

To manually sync for updating, on the Applications screen, tap **S Planner** → ☰ → **Sync**.

To display synced events or tasks, tap ☰ → **Calendars**, and then tick the Google account.

Handwriting on Month view

On month view screen, tap  to activate this feature. This is only available in month view in landscape mode.

Changing calendar type

Select one from among different types of calendars including year, month, week, and others at the top side of the screen.

Searching for events

Tap , and then enter a keyword to search for.

To view today's events, tap **Today** at the top of the screen.

Deleting events

Tap ☰ → **Delete**, select events by ticking, and then tap **Delete**.

Sharing events

Select an event or task, tap ☰ → **Share via**, and then select a sharing method.

POLARIS Office 5

Use this application to edit documents in various formats, including spreadsheets and presentations.

Tap **POLARIS Office 5** on the Applications screen.



Some functions may not be available, depending on the file type.

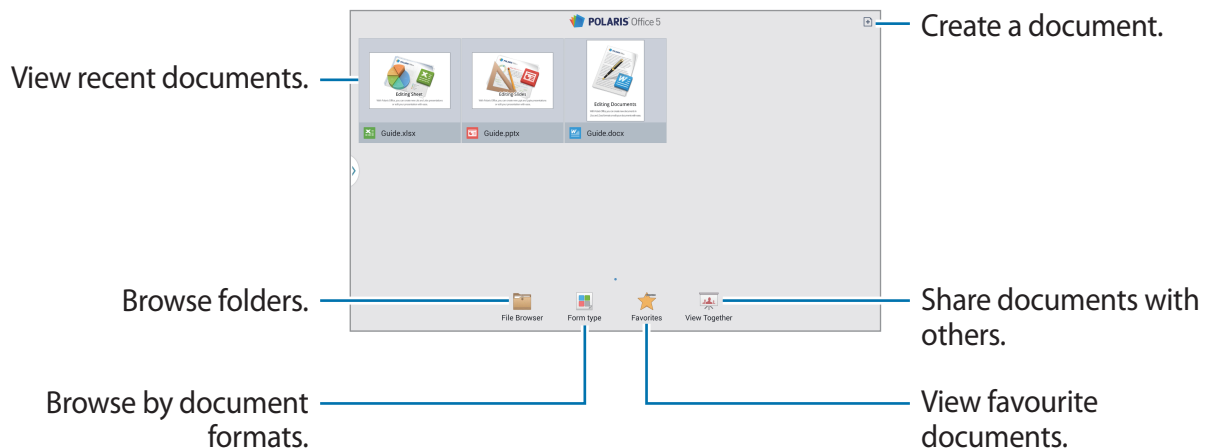

Creating documents

Tap , and then select a document type.

Use the editing toolbar at the top of the screen to edit the document.

To finish, tap the document icon at the top left of the screen, tap **Save**, enter a filename, select a folder to save to, and then tap **Save**.

To save the document as a PDF file, tap the document icon at the top left of the screen, tap **PDF export**, enter a filename, and then tap **Export**.

While editing the documents, tap , and then use one of the following functions:

- **Switch to View Mode:** Preview the document.
- **Slide note:** Edit memos on slides.
- **Find/Replace:** Search for or replace text.
- **Page layout:** Change the layout of pages.

- **Screen Conversion:** Apply animation or transition effects to slides.
- **View Settings:** Change the view mode settings.
- **Read All:** Read the document via the text-to-speech feature.
- **Filter:** View cells filtered by specific criteria.
- **Sort:** Sort cells by specific criteria.
- **Protect worksheet:** Lock the sheet so that others cannot edit it.
- **Freeze frame:** Keep the selected row in place.
- **Recalculation:** Recalculate the functions on the sheet.
- **Screen capture:** Capture the selected area.
- **View Information:** View the document details.
- **Help:** Access help information for using the POLARIS Office.

Reading documents

Tap a file on the recent documents screen. Or tap **File Browser**, **From type**, **Favorites**, or **View Together**, and then select a file to open.

To draw on the document, tap .

To search for a text string in the document, tap .

Tap , and then use one of the following functions:

- **Switch to Edit Mode:** Open the editing toolbar.
- **Bookmark:** Open the Bookmark panel. Select a label to go to bookmarks point.
- **View Settings:** Change the view mode settings.
- **Continuous view:** View slides continuously.
- **Slide note:** Edit memos on slides.
- **Freeze frame:** Keep the selected row in place.
- **Screen capture:** Capture the selected area.
- **View Information:** View the document details.
- **Help:** Access help information for using the POLARIS Office.

Sharing documents

Share documents with multiple devices that are connected to the same Wi-Fi. While sharing documents, you can write a note or draw on the screen.

To create a sharing group, tap **View Together** → . Select a document to share, enter a name and password for the sharing group, and then tap **OK**.

To join a sharing group, search for and join the sharing group with the password.

Dropbox



Use this application to save and share files with others via the Dropbox cloud storage. When you save files to Dropbox, your device automatically syncs with the web server and any other computers that have Dropbox installed.

Tap **Dropbox** on the Applications screen.





This application may not be available depending on the region or service provider.

When running Dropbox for the first time, tap **Start** to activate it. Follow the on-screen instructions to complete the setup.

Once Dropbox is activated, photos and videos taken with the device's camera are uploaded to Dropbox automatically. To view the uploaded photos or videos, tap . To share or delete files or create albums, tap , and then select files.

To upload files to Dropbox, tap  →  → **Upload here** → **Photos or videos** or **Other files**.

To open files in Dropbox, select a file.

While viewing images or videos, tap  to add it to the favourites list. To open files in the favourites list, tap .

Cloud

Use this feature to sync files or back up settings and application data with your Samsung account or Dropbox.

On the Applications screen, tap **Settings** → **General** → **Cloud**.



This feature may not be available depending on the region or service provider.

Syncing with the Samsung account

Tap your Samsung account or **Sync settings** to sync files.

Backing up or restoring data

Tap **Backup** to back up or tap **Restore** to restore data with your Samsung account.

Syncing with Dropbox

Tap **Link Dropbox account**, and then enter the Dropbox account. Follow the on-screen instructions to complete the setup.

Once you sign in, tap **Allow** and the device automatically syncs files with Dropbox whenever you make some changes.

Alarm

Use this application to set wake-up calls and alarms for important events.

Tap **Alarm** on the Applications screen.

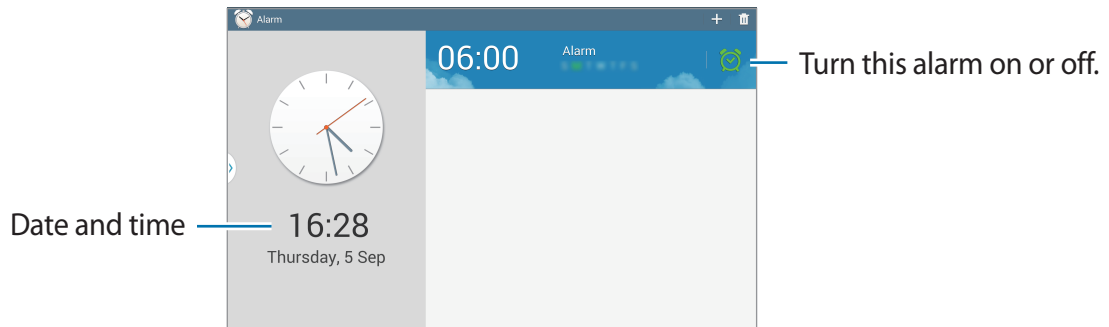

Setting alarms

Tap **+**, set a time for the alarm to go off, select days for the alarm to repeat, and then tap **Save**. You can also set an alarm by writing numbers with the S Pen.

- **Location alarm:** Set a location. The alarm goes off only when you are in the location.
- **Snooze:** Set an interval and the number of times for the alarm to repeat after the preset time.
- **Smart alarm:** Set a time for the alarm to go off before the preset time.

Stopping alarms

Drag **X** outside the large circle to stop an alarm. Drag **ZZ** outside the large circle to repeat the alarm after a specified length of time.

Deleting alarms

Tap and hold the alarm, and then tap **Delete**.

World Clock

Use this application to check the time of many major cities in the world.

Tap **World Clock** on the Applications screen.

Creating clocks

Tap **+**, and then enter a city name or select a city from the cities list or globe, and then tap **+**.

To apply summer time, tap and hold a clock, and then tap **DST settings**.

Deleting clocks

Tap and hold the clock, and then tap **Delete**.

Calculator

Use this application for simple or complex calculations.

Tap **Calculator** on the Applications screen.

To clear the history, tap **☰** → **Clear history**.

S Translator

Use this application to translate text into other languages.

Tap **S Translator** on the Applications screen.

To start **S Translator**, you need to download and install the application. Tap **Install**, and then follow the on-screen instructions.

S Voice

Use this application to command the device by voice to perform various features.

Tap **S Voice** on the Applications screen. Alternatively, press the Home button twice.



- This application may not be available depending on the region or service provider.
- This application is not supported in some languages.

Here are several examples of spoken commands:

- Open music
- Launch calculator
- Check schedule

Tips for better voice recognition

- Speak clearly.
- Speak in quiet places.
- Do not use offensive or slang words.
- Avoid speaking in dialectal accents.

The device may not recognise your commands or may perform unwanted commands depending on your surroundings or how you speak.

Using wake-up commands on the locked screen

On the locked screen, you can use various functions with preset wake-up commands.

To activate this feature, on the Applications screen, tap **Settings** → **Device** → **Lock screen**, and then drag the **Wake up in lock screen** switch to the right.

S Finder

Use this application to search a wide variety of items on the device, including emails, documents, images, music, applications, and more.

Tap and hold  to launch **S Finder**.

Tap the search field, and then enter search criteria. Alternatively, tap , and then speak a keyword. You can also use this feature to search the handwritten content in the device.

Google

Use this application to search not only the Internet, but also applications and their contents on the device as well.

Tap **Google** on the Applications screen.



This application may not be available depending on the region or service provider.

Searching the device

Tap the search field, and then enter a keyword. Alternatively, tap , and then speak a keyword.

If no results are returned from the applications, the web browser appears, displaying the search results.

Search scope

To select what applications to search, tap  → **Settings** → **Tablet search**, and then tick the items to search for.

Google Now

Launch Google search to view Google Now cards that show the current weather, public transit info, your next appointment, and more when you are most likely to need it.

Join Google Now when opening Google search for the first time. To change Google Now settings, tap  → **Settings** → **Google Now**.

Scrapbook

Use this application to create your own digital scrapbook with content from webpages, videos and more.

Tap **Scrapbook** on the Applications screen.



This application may not be available depending on the region or service provider.

Creating categories

Tap  → **Create category**, select a layout from the list, enter a name, and then tap **OK**.

Collecting items

While viewing webpages, or videos, with the S Pen button pressed, draw a line around an area to select it. Tap **Scrapbook** from the list of applications that appears at the bottom of the screen, and then select a category to add the selected area.

Alternatively, tap **Scrapbooker** on the air command, draw a line around an area, and then tap



Viewing items

Select a category, and then select an item. While viewing an item, tap **Link** to go to the source it was collected from.

Voice Search

Use this application to search webpages by speaking.

Tap **Voice Search** on the Applications screen.



This application may not be available depending on the region or service provider.

Speak a keyword or phrase when **Speak now** appears on the screen.

My Files

Use this application to access all kinds of files stored in the device, including images, videos, songs, and sound clips.

Tap **My Files** on the Applications screen.

Viewing files

Select a category and then tap a folder to open it. To view the uploaded photos or videos in Dropbox, tap **Dropbox**, and then sign in to your Dropbox account.

In a folder, tap , and then use one of the following options:

- **Add FTP:** Add an FTP server shortcut to the shortcuts area.
- **Select item:** Select files or folders.
- **Sort by:** Sort files or folders.
- **Add shortcut:** Add a shortcut of the folder to the shortcuts area.
- **Scan for Nearby Devices:** Search for devices that have media sharing activated.
- **Settings:** Change the file manager settings.

Searching for a file

Tap , tap the search field at the top of the screen, and then enter search criteria.

Adding shortcuts to folders

Add a shortcut of frequently-used folders to the shortcuts area. In a folder, tap  → **Add shortcut**.

Adding FTP server shortcut to the device

Add a FTP server shortcut to the shortcuts area. Tap  → **Add FTP**, enter details such as server address, user name, and password, and then tap **Done**.

Downloads

Use this application to see what files are downloaded through the applications.

Tap **Downloads** on the Applications screen.



This application may not be available depending on the region or service provider.

Select a file to open it with an appropriate application.

To sort the files by size, tap **Sort by size**.

To sort the files by date, tap **Sort by date**.

TripAdvisor

Use this application to get travel information such as destination or hotel. You can also book for a room and share your reviews with others.

Tap **TripAdvisor** on the Applications screen.

To start **TripAdvisor**, you need to download and install the application. Tap **Install**, and then follow the on-screen instructions.



This application may not be available depending on the region or service provider.

Evernote

Use this application to create, synchronise, and share multimedia notes that you create. You can add tags to the notes, or sort the notes into a notebook so that you can manage your ideas efficiently.

Tap **Evernote** on the Applications screen.



This application may not be available depending on the region or service provider.

KNOX

Use this application freely use your device for both work and personal use.

Tap **KNOX** on the Applications screen.

To start **KNOX**, you need to download and install the application. Tap **Install**, and then follow the on-screen instructions.



- This application may not be available depending on the region or service provider.
- To secure your data, **KNOX** and associated data is deleted when the password is entered incorrectly several times.

Travel & local

Maps

Use this application to pinpoint the location of the device, search for places, or get directions. Tap **Maps** on the Applications screen.



This application may not be available depending on the region or service provider.

Searching for locations

Search for locations by entering an address or a keyword. Once the location is found, select a location to view the detailed information. Refer to the help for more information.

Getting directions for a destination

Tap **Y** to set starting and ending locations, and then select a travel method. The device shows the routes to get to the destination.

Settings

About Settings

Use this application to configure the device, set application options, and add accounts. Tap **Settings** on the Applications screen.

Connections

Wi-Fi

Activate the Wi-Fi feature to connect to a Wi-Fi network and access the Internet or other network devices.

To use options, tap **Wi-Fi** → .

- **Advanced:** Customise Wi-Fi settings.
- **WPS push button:** Connect to a secured Wi-Fi network with a WPS button.
- **WPS PIN entry:** Connect to a secured Wi-Fi network with a WPS PIN.
- **Help:** Access help information for Wi-Fi.

Setting Wi-Fi sleep policy

Tap **Wi-Fi** →  → **Advanced** → **Keep Wi-Fi on during sleep**.

Setting Network notification

The device can detect open Wi-Fi networks and display an icon on the status bar to notify when available.

Tap **Wi-Fi** →  → **Advanced** and tick **Network notification** to activate this feature.

Wi-Fi Direct

Wi-Fi Direct connects two devices directly via a Wi-Fi network without requiring an access point.

Tap **Wi-Fi** → **Wi-Fi Direct**.

Bluetooth

Activate the Bluetooth feature to exchange information over short distances.

To use more options, tap .

- **Visibility timeout:** Set duration that the device is visible.
- **Received files:** View received files via the Bluetooth feature.
- **Help:** Access help information for Bluetooth.

Flight mode

This disables all wireless functions on your device. You can use only non-network services.

Data usage

Keep track of your data usage amount.

To use more options, tap .

- **Auto sync data:** Activate or deactivate auto-syncing of applications. You can select what information to sync for each account in **Settings** → **General** → **Accounts**.
- **Mobile hotspots:** Select Wi-Fi hotspots to prevent applications that are running in the background from using them.

Location services

Change settings for location information permissions.

- **Access to my location:** Set the device to allow applications to use your current location information.
- **Use GPS satellites:** Set the device to use the GPS satellite for finding the current location.
- **Use wireless networks:** Set the device to allow location data collection or to determine the location of your lost or stolen device via Wi-Fi.
- **My places:** Set up profiles that will be used for specific locations when you use GPS, Wi-Fi, or Bluetooth features to find your current location.

More networks

Customise settings to control networks.

VPN

Set up and connect to virtual private networks (VPNs).

Nearby devices

- **Device name:** Enter a media server name for your device.
- **Shared contents:** Set the device to share your content with other devices.
- **Allowed devices list:** View the list of devices that can access your device.
- **Not-allowed devices list:** View the list of devices that are blocked from accessing your device.
- **Download to:** Select a memory location for saving media files.
- **Upload from other devices:** Set the device to accept uploads from other devices.

Screen Mirroring

Activate the screen mirroring feature and share your display with others.

Device

Sound

Change settings for various sounds on the device.

- **Volume:** Adjust the volume level for music and videos, system sounds, and notifications.
- **Vibration intensity:** Adjust the force of the vibration notification.
- **Default notification sound:** Select a ringtone for events, such as incoming messages.
- **Touch sounds:** Set the device to sound when selecting an application or option on the touch screen.
- **Screen lock sound:** Set the device to sound when locking or unlocking the touch screen.
- **Haptic feedback:** Set the device to vibrate when touching keys.
- **Pen attach/detach sound:** Set the device to emit a sound when the S Pen is inserted or pulled out from the slot.
- **Key-tap sound:** Set the device to sound when a key is touched.
- **Key-tap vibration:** Set the device to vibrate when a key is touched.
- **Audio output:** Select a sound output format to use when connecting your device to HDMI devices. Some devices may not support the surround sound setting.
- **Adapt Sound:** Personalise the sound for the ear you use most while listening to music.

Display

- **Brightness:** Set the brightness of the display.
- **Screen timeout:** Set the length of time the device waits before turning off the display's backlight.
- **Touch key light duration:** Set the duration for the touch button backlight.

- **Screen mode:**
 - **Adapt display:** Use this mode for optimising the display according to the display settings.
 - **Dynamic:** Use this mode to make the display tone more vivid.
 - **Standard:** Use this mode for normal surroundings.
 - **Movie:** Use this mode for dim surroundings, such as in a dark room.
- **Reading mode:** Select which applications will use reading mode. In reading mode, the device helps protect your eyes when reading at night.
- **Daydream:** Set the device to launch a screensaver when your device is connected to a desktop dock or charging.
- **Display battery percentage:** Set the device to display the remaining battery life.
- **Edit after screen capture:** Set the device to edit the screenshot after capturing it.

Multi window

Set the device to use Multi Window.

Lock screen

Change settings for the locked screen.

- **Screen lock:** Activate the screen lock feature. The following options may vary depending on the screen lock feature selected.
- **Multiple widgets:** Set the device to allow use of widgets on the locked screen.
- **Clock widget options:** Configure settings for the clock widget.
 - **Clock size:** Change the size of the clock.
 - **Show date:** Set the device to show the date with the clock.
- **Shortcuts:** Set the device to show and edit application shortcuts on the locked screen.



This feature may not be available depending on the region or service provider.

- **Personal message:** Edit the personal message.
- **Owner information:** Enter your information that is shown with the clock.
- **Unlock effect:** Select an effect when you unlock the screen.
- **Ink effect:** Change the colour for the ink effect. The ink effect is available only with the S Pen.
- **Wake up in lock screen:** Set the device to recognise your wake up command when the screen is locked.
- **Action Memo on lock screen:** Set the device to launch Action Memo when you double-tap the locked screen with the S Pen button pressed.
- **Help text:** Set the device to show the help text on the locked screen.

Wallpaper

Change the settings for the wallpaper.

- **Home screen:** Select a background image for the Home screen.
- **Lock screen:** Select a background image for the locked screen.
- **Home and lock screens:** Select a background image for the Home screen and the locked screen.

Font

Change the settings for the font.

- **Font style:** Change the font type for display text.
- **Font size:** Change the font size.

Notification panel

Customise the items that appear on the notifications panel.

Accessibility

Accessibility services are special features for those with certain physical disabilities. Access and alert the following settings to improve accessibility to the device.

- **Auto rotate screen:** Set the interface to rotate automatically when you rotate the device.
- **Screen timeout:** Set the length of time the device waits before turning off the display's backlight.
- **Speak passwords:** Set the device to read aloud passwords you enter with Talkback.
- **Easy touch mode:** Set this to control notifications by tapping the button instead of dragging it.
- **Show shortcut:** Add a shortcut to **Accessibility** on the quick menu that appears when you press and hold the Power button.
- **Manage accessibility:** Export or import the accessibility settings to share them with other devices.
- **TalkBack:** Activate Talkback, which provides voice feedback.
- **Font size:** Change the font size.
- **Magnification gestures:** Set the device to zoom in and out with finger gestures.
- **Negative colours:** Reverse the display colours to improve visibility.
- **Colour adjustment:** Adjust the colour scheme for the screen when the device determines that you are colour blind or having difficulty reading content.
- **Notifications reminder:** Activate or deactivate beep sounds for new notifications.
- **Accessibility shortcut:** Set the device to activate Talkback when you press and hold the Power button, and then tap and hold the screen with two fingers.
- **Text-to-speech options:**
 - **Preferred TTS engine:** Select a speech synthesis engine. To change the settings for speech synthesis engines, tap .
 - **Speech rate:** Select a speed for the text-to-speech feature.
 - **Listen to an example:** Listen to the spoken text for an example.

- **Sound balance:** Adjust the sound balance when using a dual headset.
- **Mono audio:** Enable mono sound when listening to audio with one earbud.
- **Turn off all sounds:** Mute all device sounds.
- **Flash notification:** Set the flash to blink when you have new messages or notifications.
- **Assistant menu:** Set the device to show the assistive shortcut icon that helps you access functions supported by external buttons or features on the notifications panel. You can also edit the menu on the shortcut icon.
- **Tap and hold delay:** Set the recognition time for tapping and holding the screen.
- **Interaction control:** Set an area of the screen to be excluded from touch inputs.

Blocking mode

Select which notifications will be blocked and how long to block them.

Controls

Language and input

Change the settings for text input. Some options may not be available depending on the selected language.

Language

Select a display language for all menus and applications.

Default

Select a default keyboard type for text input.

Samsung keyboard

To change the Samsung keyboard settings, tap .



The available options may vary depending on the region or service provider.

- **Input languages:** Select languages for text input.
- **Predictive text:** Activate predictive text mode to predict words based on your input and show word suggestions. You can also customise the word prediction settings.
- **Auto replacement:** Set the device to correct misspelled and incomplete words by tapping the space bar or punctuation mark.
- **Auto capitalisation:** Set the device to automatically capitalise the first character after a final punctuation mark, such as a full stop, question mark, or exclamation mark.
- **Auto spacing:** Set the device to automatically insert a space between words.
- **Auto-punctuate:** Set the device to insert a full stop when you double-tap the space bar.
- **None:** Set the device to deactivate the keyboard swipe feature.
- **Continuous input:** Set the device to enter text by sweeping on the keyboard.
- **Cursor control:** Enable the smart keyboard navigation feature to move the cursor by scrolling the keyboard.
- **Sound:** Set the device to sound when a key is touched.
- **Vibration:** Set the device to vibrate when a key is touched.
- **Character preview:** Set the device to display a large image of each character tapped.
- **Pen detection:** Set the device to open the handwriting panel when the field is tapped with the S Pen.
- **Help:** Access help information for using the Samsung keyboard.
- **Reset settings:** Reset Samsung keyboard settings.

Google voice typing

To change the voice input settings, tap .

- **Choose input languages:** Select input languages for text input.
- **Block offensive words:** Set the device to prevent the device from recognising offensive words in voice inputs.
- **Download offline speech recognition:** Download and install language data for offline voice input.

Handwriting recognition

Select a search language for handwriting search.

Voice search

- **Language:** Select a language for the voice recognition.
- **Speech output:** Set the device to provide voice feedback to alert you to the current action.
- **Block offensive words:** Hide offensive words from voice search results.
- **Download offline speech recognition:** Download and install language data for offline voice input.
- **Bluetooth headset:** Set the device to allow a voice search with a Bluetooth headset, when it is connected to the device.

Text-to-speech options

- **Preferred TTS engine:** Select a speech synthesis engine. To change the settings for speech synthesis engines, tap .
- **Speech rate:** Select a speed for the text-to-speech feature.
- **Listen to an example:** Listen to the spoken text for an example.

Pointer speed

Adjust the pointer speed for the mouse or trackpad connected to your device.

Voice control

Set the device to recognise voice commands for controlling your device. You can select the features to control with voice commands.

S Pen

Change the settings for using the S Pen.

- **Disable pen detection:** Set the screen not to respond when inserting or removing the S Pen.
- **Pointer:** Set the device to display the S Pen pointer when hovering the S Pen over the screen.
- **Direct pen input:** Set the device to launch handwriting pad when hovering the S Pen over a text input field.
- **Air view:** Set the device to show the S Pen pointer when the S Pen is hovering over the screen.
- **Air command:** While hovering over an item with the S Pen, press the pen button to display a list of options for the item or air command.
- **Sound and haptic feedback:** Set the device to sound and vibrate when pointing at items with your finger.
- **Pen detachment options:** Set the device to launch Action Memo or Pen launcher when the S Pen is pulled out from the slot.
- **Pen attach/detach sound:** Set the device to emit a sound when the S Pen is inserted or pulled out from the slot.

Motions

Activate the motion recognition feature and change the settings that control motion recognition on your device.

- **Zoom:** Set the device to zoom in or out while viewing images in **Gallery** or browsing webpages, when you tap and hold two points with your fingers and then tilt the device back and forth.
- **Move an icon:** Set the device to sound and vibrate when pointing at items with your finger.
- **Browse an image:** Set the device to scroll through an image by moving the device in any direction when the image is zoomed in.

Palm motion

Activate the palm motion feature to control the device by touching the screen.

- **Capture screen:** Set the device to capture an image of the screen when you sweep your hand to the left or right across the screen.
- **Mute/Pause:** Set the device to pause media playback when you touch the screen with your palm.

Smart screen

- **Smart stay:** Set the device to prevent the display backlight from turning off while you are looking at the display.
- **Smart rotation:** Set the interface not to rotate according to the orientation of your face.
- **Smart pause:** Set the device to pause video playback when you look away from the screen.
- **Smart scroll:**
 - **Scroll by:** Select a method to scroll the screen up or down.
 - **Speed:** Adjust the speed for scrolling the screen.
 - **Visual Feedback display:** Set the device to display a signal icon when the device recognises your action.



This feature may not work properly in bright light, in dark conditions, or when the device is being moved or shaken.

General

Accounts

Add email or SNS accounts.

Cloud

Change settings for syncing data or files with your Samsung account or Dropbox cloud storage.

Backup and reset

Change the settings for managing settings and data.

- **Back up my data:** Set the device to back up settings and application data to the Google server.
- **Backup account:** Set up or edit your Google backup account.
- **Automatic restore:** Set the device to restore settings and application data when the applications are reinstalled on the device.
- **Factory data reset:** Reset settings to the factory default values and delete all data.

Date and time

Access and alter the following settings to control how the device displays the time and date.



If the battery remains fully discharged or removed from the device, the time and date is reset.

- **Set date:** Set the current date manually.
- **Set time:** Set the current time manually.
- **Select time zone:** Set the home time zone.
- **Use 24-hour format:** Display time in 24-hour format.
- **Select date format:** Select a date format.

Accessory

Change the accessory settings.

- **Dock sound:** Set the device to play a sound when your device is connected to or removed from a desktop dock.
- **Audio output mode:** Set the device to use the dock speaker when your device is connected to a desktop dock.
- **Audio output:** Select a sound output format to use when connecting your device to HDMI devices. Some devices may not support the surround sound setting.
- **Daynote:** Set the device to show the quick note pad when the cover is flipped open.
- **Unit:** Set unit options.

Application manager

View and manage the applications on your device.

Battery

View the amount of battery power consumed by your device.

Power saving mode

Activate power-saving mode and change the settings for power-saving mode.

- **CPU power saving:** Set the device to limit some system resource usage.
- **Screen power saving:** Set the device to decrease the brightness of the display.
- **Turn off haptic feedback:** Set the device to turn off the vibration when touching keys.
- **Learn about Power saving:** Discover how to reduce battery consumption.

Storage

View memory information for your device and memory card, or format a memory card.



Formatting a memory card permanently deletes all data from it.



The actual available capacity of the internal memory is less than the specified capacity because the operating system and default applications occupy part of the memory. The available capacity may change when you upgrade the device.

Security

Change settings for securing the device and the SIM or USIM card.

- **Encrypt device:** Set a password to encrypt data saved on the device. You must enter the password each time you turn on the device.



Charge the battery before enabling this setting because it may take more than an hour to encrypt your data.

- **Encrypt external SD card:** Set the device to encrypt files on a memory card.



If you reset your device to the factory defaults with this setting enabled, the device will not be able to read your encrypted files. Disable this setting before resetting the device.

- **Remote controls:** Set the device to allow control of your lost or stolen device remotely via the Internet. To use this feature, you must sign in to your Samsung account.
 - **Account registration:** Add or view your Samsung account.
 - **Use wireless networks:** Set the device to allow location data collection or to determine the location of your lost or stolen device via Wi-Fi.
- **Go to the find my mobile webpage:** Access the Find my mobile website (findmymobile.samsung.com). You can track and control your lost or stolen device on the Find my mobile website.

- **Reactivation lock:** Set the device to require your Samsung account after the device has been reset to prevent others from reactivating the device.
- **Make passwords visible:** By default, the device hides passwords for security. Set the device to display passwords as they are entered.
- **Device administrators:** View device administrators installed on the device. You can allow device administrators to apply new policies to the device.
- **Unknown sources:** Choose to install applications from any source. If not chosen, download applications only from Play Store.
- **Verify apps:** Set this to allow Google to check the application for harmful behaviour before installing it.
- **Change security level:** Select the level for actions under security policy.
- **Auto update security:** Set the device to check and download security updates automatically.
- **Via Wi-Fi only:** Set the device to download security updates automatically only when the device is connected to a Wi-Fi network.
- **Storage type:** Set a storage type for credential contents.
- **Trusted credentials:** Use certificates and credentials to ensure secure use of various applications.
- **Install from device storage:** Install encrypted certificates stored on the USB storage.
- **Clear credentials:** Erase the credential contents from the device and reset the password.

About device

Access device information and update device software.

Google Settings

Use this application to configure settings for some features provided by Google.

Tap **Google Settings** on the Applications screen.

Troubleshooting

Before contacting a Samsung Service Centre, please attempt the following solutions. Some situations may not apply to your device.

When you turn on your device or while you are using the device, it prompts you to enter one of the following codes:

- **Password:** When the device lock feature is enabled, you must enter the password you set for the device.
- **PIN:** When using the device for the first time or when the PIN requirement is enabled, you must enter the PIN supplied with the SIM or USIM card. You can disable this feature by using the Lock SIM card menu.
- **PUK:** Your SIM or USIM card is blocked, usually as a result of entering your PIN incorrectly several times. You must enter the PUK supplied by your service provider.
- **PIN2:** When you access a menu requiring the PIN2, you must enter the PIN2 supplied with the SIM or USIM card. For details, contact your service provider.

Your device displays network or service error messages

- When you are in areas with weak signals or poor reception, you may lose reception. Move to another area and try again. While moving, error messages may appear repeatedly.
- You cannot access some options without a subscription. Contact your service provider for more details.

Your device does not turn on

- When the battery is completely discharged, your device will not turn on. Charge the battery completely before turning on the device.
- The battery may not be inserted properly. Insert the battery again.
- Wipe both gold-coloured contacts and insert the battery again.

The touch screen responds slowly or improperly

- If you attach a protective cover or optional accessories to the touch screen, the touch screen may not function properly.
- If you are wearing gloves, if your hands are not clean while touching the touch screen, or if you tap the screen with sharp objects or your fingertips, the touch screen may malfunction.
- The touch screen may malfunction in humid conditions or when exposed to water.
- Restart your device to clear any temporary software bugs.
- Ensure that your device software is upgraded to the latest version.
- If the touch screen is scratched or damaged, visit a Samsung Service Centre.

Your device freezes or has fatal errors

If your device freezes or hangs, you may need to close applications or reinsert the battery and turn on the device to regain functionality. If your device is frozen and unresponsive, press and hold the Power button for more than 7 seconds to reboot.

If this does not solve the problem, perform a factory data reset. On the Applications screen, tap **Settings** → **General** → **Backup and reset** → **Factory data reset** → **Reset device** → **Erase everything**. Before performing the factory data reset, remember to make back-up copies of all important data stored on the device.

If the problem is still not resolved, contact a Samsung Service Centre.

Calls are not connected

- Ensure that you have accessed the right cellular network.
- Ensure that you have not set call barring for the phone number you are dialling.
- Ensure that you have not set call barring for the incoming phone number.

Others cannot hear you speaking on a call

- Ensure that you are not covering the built-in microphone.
- Ensure that the microphone is close to your mouth.
- If using a headset, ensure that it is properly connected.

Sound echoes during a call

Adjust the volume by pressing the Volume button or move to another area.

A cellular network or the Internet is often disconnected or audio quality is poor

- Ensure that you are not blocking the device's internal antenna.
- When you are in areas with weak signals or poor reception, you may lose reception. You may have connectivity problems due to issues with the service provider's base station. Move to another area and try again.
- When using the device while moving, wireless network services may be disabled due to issues with the service provider's network.

The battery icon is empty

Your battery is low. Recharge or replace the battery.

The battery does not charge properly (For Samsung-approved chargers)

- Ensure that the charger is connected properly.
- If the battery terminals are dirty, the battery may not charge properly or the device may turn off. Wipe both gold-coloured contacts and try charging the battery again.
- The batteries in some devices are not user-replaceable. To have the battery replaced, visit a Samsung Service Centre.

The battery depletes faster than when first purchased

- When you expose the battery to very cold or very hot temperatures, the useful charge may be reduced.
- Battery consumption increases when you use messaging features or some applications, such as games or the Internet.
- The battery is consumable and the useful charge will get shorter over time.

Your device is hot to the touch

When you use applications that require more power or use applications on your device for an extended period of time, your device may feel hot to the touch. This is normal and should not affect your device's lifespan or performance.

Error messages appear when launching the camera

Your device must have sufficient available memory and battery power to operate the camera application. If you receive error messages when launching the camera, try the following:

- Charge the battery or replace it with a battery that is fully charged.
- Free some memory by transferring files to a computer or deleting files from your device.
- Restart the device. If you are still having trouble with the camera application after trying these tips, contact a Samsung Service Centre.

Photo quality is poorer than the preview

- The quality of your photos may vary, depending on the surroundings and the photography techniques you use.
- If you take photos in dark areas, at night, or indoors, image noise may occur or images may be out of focus.

Error messages appear when opening multimedia files

If you receive error messages or files do not play, when opening multimedia files on your device, try the following:

- Free some memory by transferring files to a computer or deleting files from your device.
- Ensure that the music file is not Digital Rights Management (DRM)-protected. If the file is DRM-protected, ensure that you have the appropriate licence or key to play the file.
- Ensure that your device supports the file type.

- Your device supports photos and videos captured with the device. Photos and videos captured by other devices may not work properly.
- Your device supports multimedia files that are authorised by your network service provider or providers of additional services. Some content circulated on the Internet, such as ringtones, videos, or wallpapers, may not work properly.

Another Bluetooth device is not located

- Ensure that the Bluetooth wireless feature is activated on your device.
- Ensure that the Bluetooth wireless feature is activated on the device you wish to connect to.
- Ensure that your device and the other Bluetooth device are within the maximum Bluetooth range (10 m).

If the tips above do not solve the problem, contact a Samsung Service Centre.

A connection is not established when you connect the device to a computer

- Ensure that the USB cable you are using is compatible with your device.
- Ensure that you have the proper driver installed and updated on your computer.
- If you are a Windows XP user, ensure that you have Windows XP Service Pack 3 or higher installed on your computer.
- Ensure that you have Samsung Kies or Windows Media Player 10 or higher installed on your computer.

Your device cannot find your current location

GPS signals may be obstructed in some locations, such as indoors. Set the device to use Wi-Fi or a mobile network to find your current location in these situations.

Data stored on the device has been lost

Always make backup copies of all important data stored on the device. Otherwise, you cannot restore data if it is corrupted or lost. Samsung is not responsible for the loss of data stored on the device.

A small gap appears around the outside of the device case

- This gap is a necessary manufacturing feature and some minor rocking or vibration of parts may occur.
- Over time, friction between parts may cause this gap to expand slightly.

Some content may differ from your device depending on the region, service provider, or software version, and is subject to change without prior notice.

