

XPS 10 Tablet  
User's Manual



# Notes, Cautions, and Warnings



**NOTE:** A NOTE indicates important information that helps you make better use of your tablet PC.



**CAUTION:** A CAUTION indicates potential damage to hardware or loss of data if instructions are not followed.



**WARNING:** A WARNING indicates a potential for property damage, personal injury, or death.

-----  
© 2012 Dell Inc.

Trademarks used in this text: Dell™ and the DELL logo are trademarks of Dell Inc.; Adobe Acrobat® is a trademark of Adobe Systems Incorporated which may be registered in certain jurisdictions; Microsoft®, Windows®, Excel®, Powerpoint®, and Internet Explorer® are either trademarks or registered trademarks of Microsoft Corporation in the United States and/or other countries; Bluetooth® is a registered trademark owned by Bluetooth SIG, Inc. and is used by Dell under license.

November 2012 Rev. A00

## Federal Communications Commission (FCC) Statement

**This tablet PC complies with Part 15 of the FCC Rules. Operation is subject to the following two conditions:**

- 1) this tablet PC may not cause harmful interference and
- 2) this tablet PC must accept any interference received, including interference that may cause undesired operation of the tablet PC.

## Mexico COFETEL regulatory Statement

[http://www.dell.com/downloads/global/corporate/enviro/comply/Mexico\\_all\\_pdf.pdf](http://www.dell.com/downloads/global/corporate/enviro/comply/Mexico_all_pdf.pdf)

# Contents

1	XPS 10 Tablet Features . . . . .	5
2	XPS 10 Tablet Accessories . . . . .	10
3	Setting Up Your XPS 10 Tablet . . . . .	11
	<b>Getting Your Tablet Ready for Use . . . . .</b>	<b>11</b>
	<b>Charging the tablet . . . . .</b>	<b>12</b>
	<b>Turning On Your Tablet . . . . .</b>	<b>14</b>
	<b>Turning Off Your Tablet . . . . .</b>	<b>15</b>
	<b>Turning Off the Screen . . . . .</b>	<b>15</b>
	<b>Inserting a Micro-SD card . . . . .</b>	<b>16</b>
4	Using Your XPS 10 Tablet . . . . .	17
	<b>Screen Orientation . . . . .</b>	<b>17</b>
	<b>Gestures . . . . .</b>	<b>17</b>
	<b>The Windows 8 Start Screen . . . . .</b>	<b>20</b>
	<b>Using Headphones . . . . .</b>	<b>22</b>
	<b>Managing Your Tablet Settings . . . . .</b>	<b>23</b>
5	Synchronizing Your Tablet . . . . .	26

6	Using XPS 10 Mobile Keyboard Dock . . . . .	27
	<b>Mobile Keyboard Dock Features</b> . . . . .	<b>27</b>
	<b>Docking Your Tablet to the Keyboard Dock</b> . . . . .	<b>29</b>
	<b>Undocking Your Tablet from the Keyboard Dock</b> . . . . .	<b>31</b>
	<b>Charging the tablet and dock</b> . . . . .	<b>32</b>
7	Cleaning Your Tablet . . . . .	35
8	Troubleshooting . . . . .	36
9	Locating Your Service Tag and Express Service Code . . . . .	39
10	Specifications . . . . .	40
11	Glossary . . . . .	42
12	Index . . . . .	46

# XPS 10 Tablet Features

This section provides information about the features available on your tablet.

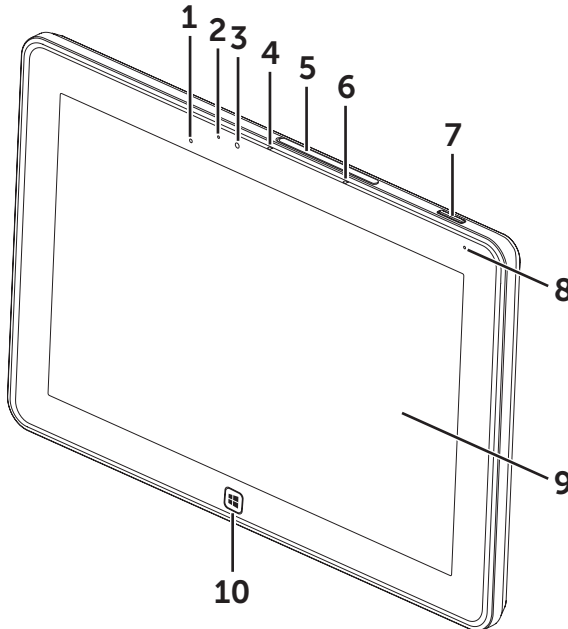

Feature	Functionality
1 Ambient-light sensor	Automatically adjusts the brightness of the display's backlight based on surrounding light levels.
2 Camera-status light	Indicates the camera activity.
3 Front-facing camera	<ul style="list-style-type: none"><li>• Capture a front view picture or record videos.</li><li>• Make video calls with web applications, such as Skype.</li></ul>

Feature	Functionality
4 Front microphone 1	<ul style="list-style-type: none"> <li>• Captures sounds.</li> <li>• Records voice for calls made from web applications, such as Skype.</li> </ul>
5 Slot cover	Provides access to Micro-SD card slot.
6 Front microphone 2	<ul style="list-style-type: none"> <li>• Captures sounds.</li> <li>• Records voice for calls made from web applications, such as Skype.</li> </ul>
7 Power and Sleep/Wake button	<ul style="list-style-type: none"> <li>• Press and hold to turn the tablet on or off.</li> <li>• Press to turn the touchscreen display on or off.</li> </ul>
8 Battery-status light	Indicates the battery charge status.
9 Touchscreen display	Touch the display to use on-screen controls including buttons, menu items, and the on-screen keyboard.
10 Windows button	<ul style="list-style-type: none"> <li>• Press to open the Windows Start screen.</li> <li>• Press for quick access to the most recently used application or most recently viewed screen.</li> </ul>



**NOTE:** The default resolution of the front camera is approximately 0.9 MP (16:9). If you change the camera resolution, the setting will be remembered by Windows.



**NOTE:** The front camera does not support zoom, face tracking or touch to focus.

Regulatory model: J42A

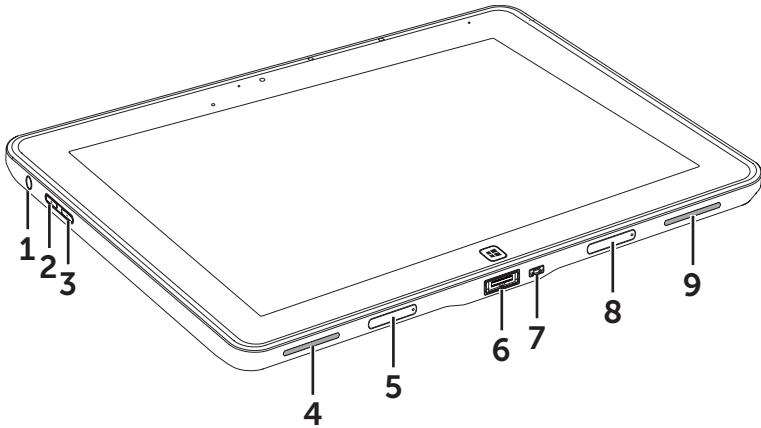

Feature	Functionality
1 Audio port (3.5 mm)	Connect headphones, microphones, and other audio equipment to listen to stereo sound, record audio or make calls.
2 Volume-up button	<ul style="list-style-type: none"> <li>• Press to increase volume by one level.</li> <li>• Press and hold to continuously increase the volume.</li> </ul>
3 Volume-down button	<ul style="list-style-type: none"> <li>• Press to decrease volume by one level.</li> <li>• Press and hold to continuously decrease the volume.</li> </ul>
4 Speaker	Provides audio output for video and music playback.
5 Removable docking-port cover	<ul style="list-style-type: none"> <li>• Protects the docking port.</li> <li>• Remove the cover to connect a Dell mobile keyboard dock (sold separately).</li> </ul>
6 Power-adapter/docking port	<ul style="list-style-type: none"> <li>• Connect the supplied power adapter to provide power to the tablet and charge the battery.</li> <li>• Connect a Dell mobile keyboard dock (sold separately).</li> </ul>

<b>Feature</b>	<b>Functionality</b>
<b>7</b> Micro-USB port	<ul style="list-style-type: none"><li>• Connect USB devices or connect to your computer for transferring or synchronizing data, music, photos, videos, contacts, and so on.</li><li>• Connect USB cable to trickle charge the battery.</li><li>• Capable of providing up to 1 amp power.</li></ul>
<b>8</b> Removable docking-port cover	<ul style="list-style-type: none"><li>• Protects the docking port.</li><li>• Remove the cover to connect a Dell mobile keyboard dock (sold separately).</li></ul>
<b>9</b> Speaker	Provides audio output for video and music playback.



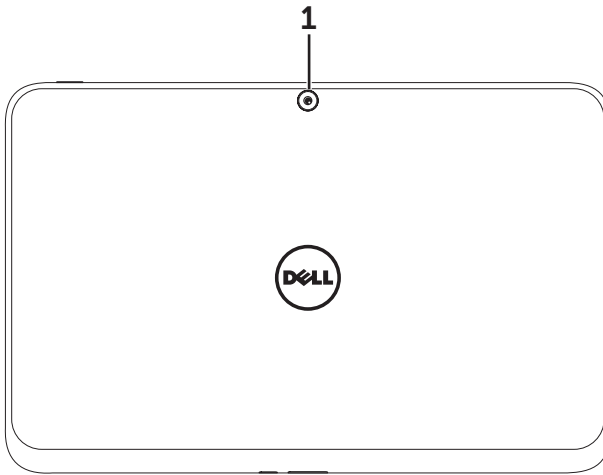

Feature	Functionality
1 Rear camera	Capture pictures or videos.

 **NOTE:** The default resolution of the rear camera is approximately 0.9 MP (16:9). If you change the camera resolution, the setting will be remembered by Windows.

 **NOTE:** The rear camera supports continuous auto-focus, but does not support zoom, face tracking or touch to focus. Auto-focus may be disabled by default but can be enabled in camera settings.

# XPS 10 Tablet Accessories

Your XPS 10 Tablet Package includes the following accessories:

**30 W AC power adapter and power cable:** Provides power to your tablet and charges the battery.

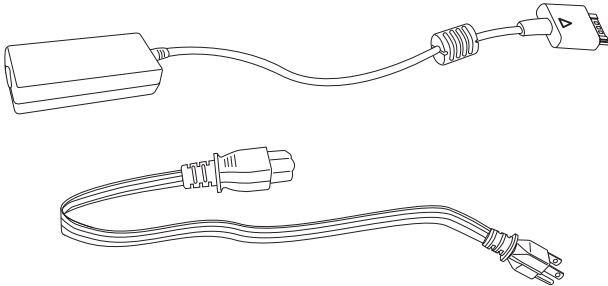

**Micro-USB to standard USB conversion cable:** Provides connection between your tablet and USB devices.

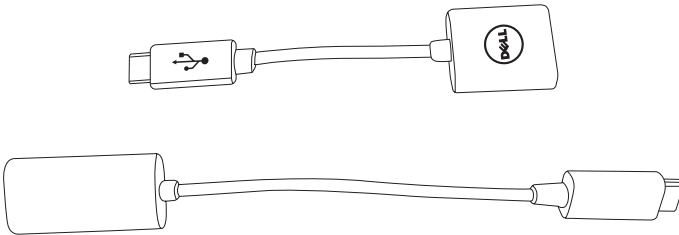

 **NOTE:** This conversion cable is not compatible with high power USB devices like hard drives or CD-ROMs.

**Mini-HDMI to HDMI cable:** Provides connection between your tablet and devices supporting audio/video signals in HDMI format.



 **NOTE:** The Mini-HDMI to HDMI cable is shipped with XPS 10 mobile keyboard dock (sold separately).

# Setting Up Your XPS 10 Tablet

This section provides information about how to set up the XPS 10 Tablet for first time use.



**WARNING:** Before you begin any of the procedures in this section, read the safety information that shipped with your tablet. For additional best practices information, see [www.dell.com/regulatory\\_compliance](http://www.dell.com/regulatory_compliance).

## Getting Your Tablet Ready for Use

### Connect the AC power adapter and power cable

- 1 Connect the supplied power cable into the supplied power adapter.

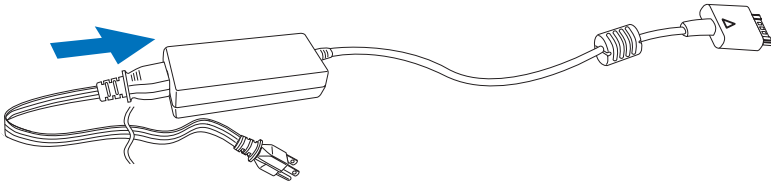

# Charging the tablet

 **CAUTION:** Charge the battery in an ambient temperature of 0 °C to 35 °C.

 **CAUTION:** Use only the supplied power adapter and power cable to charge your tablet. Using unauthorized power adapters or power cables may cause severe damage to your tablet.

 **NOTE:** The battery is not fully charged when you unpack your tablet.

- 1 Connect the power adapter to the 40-pin power-adaptor port on the tablet.

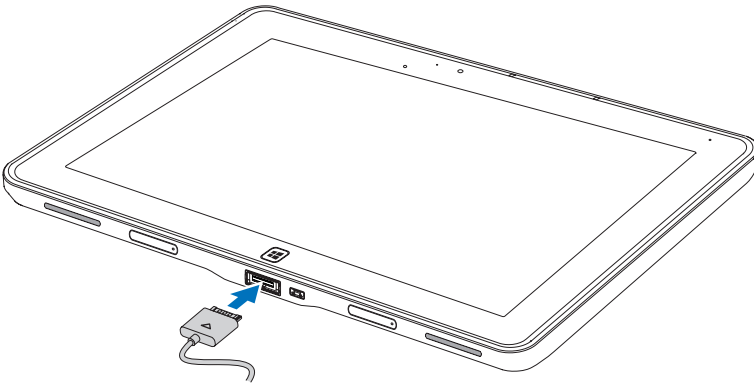

- 2 Connect the power adapter to an electrical outlet and charge the tablet until the battery is fully charged.

 **NOTE:** The tablet battery requires about 4 hours to fully charge.

 **NOTE:** You can also trickle charge the tablet via USB connection. The battery requires up to 24 hours to fully charge depending on the power output of the USB port.

You can check the tablet battery charge status from:

- Battery-charge light located on the front of the tablet:

LED behavior	Description
Solid white color on	Battery is charging.
Fast Blinking (4 times per second)	System is shutting down by pressing and holding the power button.
Off	Battery is not charging, either no AC is connected or battery is fully charged.
Momentary off	Battery is trickle charging but does not yet have enough charge to power up. If the power button is pressed during this state, the LED will be momentarily off. Continue to trickle charge or attach the AC adapter to power up immediately.





**NOTE:** You can check exact battery charge level by booting to the operating system.

- Battery icon displayed on the screen:

Battery icon	Description
	Battery is fully charged.
	Battery is charging with AC.
	Your tablet is running on battery power and the battery is discharging.
	Your tablet is plugged in, and either no battery is detected, or the battery isn't working correctly.
	Battery is at low level.
	Battery is at critical level.

# Turning On Your Tablet

 **NOTE:** Use this tablet in an ambient temperature between 0 °C and 35 °C.

- 1 Press and hold the **Power and Sleep/Wake** button  for 2 seconds to turn on your tablet.
- 2 If the lock screen image is displayed, swipe your finger from the bottom of the display to switch to the login screen, and then enter password to log in to Windows.

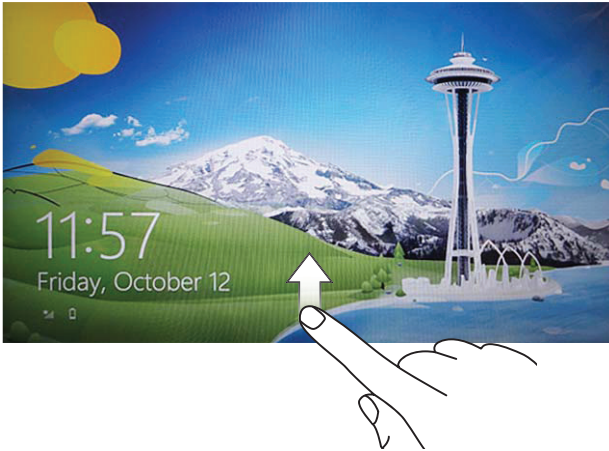

The tablet is ready for use when the Windows Start screen is displayed.

 **NOTE:** If the login screen is not enabled in Windows 8, you will be taken directly from the lock screen to the Start screen.



 **NOTE:** The lock screen is only displayed when returning from a sleep state.

## Turning Off Your Tablet

- Using power button:

Press and hold the **Power and Sleep/Wake** button  for at least 4 seconds to turn off the tablet.

- Using Charms:



- 1 Swipe from the right edge of the display to access Charms.
- 2 Touch **Settings**  → **Power**  → **Shut down** to turn off the tablet.

## Turning Off the Screen

- Using power button:



Press the **Power and Sleep/Wake** button  to turn off the screen.

- Using Charms:

- 1 Swipe from the right edge of the display to access Charms.
- 2 Touch **Settings**  → **Power**  → **Sleep** to turn off the screen.



**NOTE:** If your tablet is in a sleep state (tablet is on, but screen is off),

press the **Power and Sleep/Wake** button  or **Windows** button  once to turn on the screen.

# Inserting a Micro-SD card

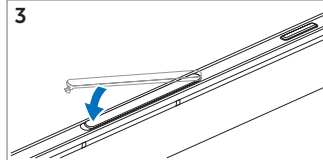
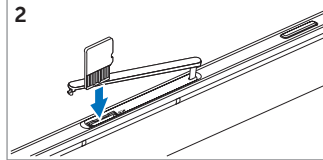
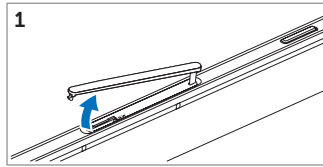
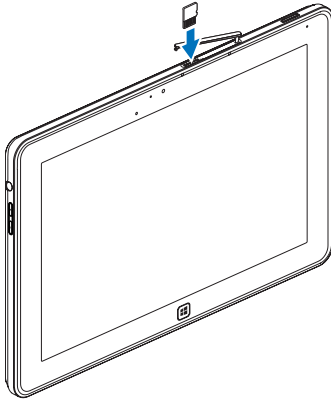

- 
- 1 Open the slot cover.

---

  - 2 Follow the illustration to insert the Micro-SD card into the Micro-SD card slot.

---

  - 3 Close the slot cover.

---

For more information on removing the Micro-SD card, see [Remove the Micro-SD card](#).



# Using Your XPS 10 Tablet





## Screen Orientation

For optimal viewing experience, the screen orientation changes automatically to portrait or landscape format depending on how you hold the tablet.



**NOTE:** Some applications may not support automatic screen rotation to portrait or landscape format.

## How to lock the screen orientation

- 1 Swipe from the right edge of the display to access Charms.
- 2 Touch **Settings**  → **Screen** .
- 3 Touch  toggle to lock the screen orientation, or touch  toggle to unlock the screen orientation.

## Gestures

Your tablet has a multi-touch display. You can touch the screen to operate the tablet.

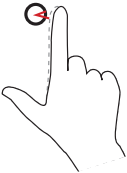
Finger gestures	Allows you to:
<p><b>Touch</b></p> <p>Tap gently on the display with your fingertip.</p> 	<ul style="list-style-type: none"><li>• Select items on the screen, including options, entries, images, and icons.</li><li>• Start applications.</li><li>• Touch buttons on the screen.</li><li>• Input text using the on-screen keyboard.</li></ul>

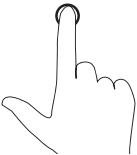
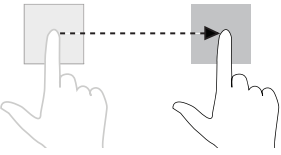
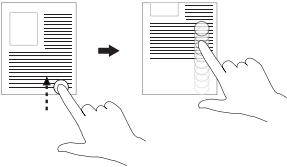
Finger gestures	Allows you to:
<p><b>Touch and Hold</b></p> <p>Touch and hold your finger on the display.</p> 	<ul style="list-style-type: none"> <li>• Display detailed information about an item.</li> <li>• Open the context menu of an item to perform further actions.</li> </ul>
<p><b>Drag</b></p> <ol style="list-style-type: none"> <li>1 Touch and hold your finger on an item on the screen.</li> <li>2 Keeping your finger in contact with the display, move your fingertip to the desired location.</li> <li>3 Take your finger off the display to drop the item in the desired location.</li> </ol> 	<ul style="list-style-type: none"> <li>• Move items such as images and icons on the screen.</li> </ul>
<p><b>Swipe or Slide</b></p> <p>Move your finger in a vertical or horizontal direction on the display.</p> 	<ul style="list-style-type: none"> <li>• Scroll through the Start screen, web pages, lists, entries, photos, contacts, and so on.</li> <li>• Close an app. (Swipe the app to the bottom of the display.)</li> </ul>

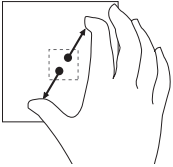
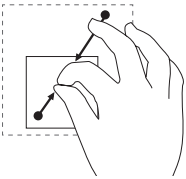
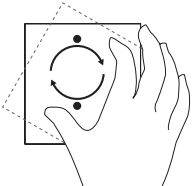
<b>Finger gestures</b>	<b>Allows you to:</b>
<p><b>Zoom in</b></p> <p>Touch the display with two fingers and then move the fingers apart.</p> 	<p>Enlarge the view of an image or web page.</p>
<p><b>Zoom out</b></p> <p>Touch the display with two fingers and then move the fingers closer.</p> 	<p>Reduce the view of an image or web page.</p>
<p><b>Rotate</b></p> <p>Touch the display with two or more fingers and then move the fingers in a clockwise or counter-clockwise arc.</p> 	<p>Rotate an object by 90 degrees.</p>



# The Windows 8 Start Screen

The Windows 8 Start screen displays a list of default and custom Live Tiles, which act as a shortcut to Control Panel, Windows Explorer, Weather app, RSS, Windows Store, Internet Explorer, and other installed applications.

Live Tiles on your Start screen change and update in real time so you can get real-time updates about news or sports, check what your friends are up to, and get the latest weather forecast.



The tile-based user interface gives you direct access to your most recently used applications, Emails, photos, music, videos, contacts, Facebook & Twitter updates, and frequently viewed websites. You can pin desired or favorite apps as Live Tiles to customize the Start screen.

You also can personalize the Start screen by setting your favorite picture as the wallpaper.

 **NOTE:** Live Tiles can be added or removed by using Pin  or Unpin  options.

## How to access the Start screen

Follow either method to access the Start screen:

- Press the **Windows** button .
- Swipe from the right edge of the display to access Charms, and then touch the **Start** icon .



## Get to know Windows 8

You can touch the Dell getting started tile on the Start screen to explore Windows 8.





## Swipe left

Swiping-in from the right edge of the display reveals Charms. Charms provide access to the system commands, such as Start, Search, Share, Devices, and Settings options.

If your tablet is running on an application or performing actions, pressing the **Start** icon  takes you back to the Start screen. If you are at the Start screen, pressing the **Start** icon  takes you to the most recently used application or most recently viewed screen.



**NOTE:** The functionality of the **Start** icon  is same as

**Windows** button .

## Swipe right

- Swiping-in quickly from the left edge of the display switches the currently running apps.
- Swiping slowly from the left edge to the right edge of the display reveals thumbnails of the open apps.
- Swiping-in and out on the left edge of the display brings up a list of the most recently used applications.

## Swipe up/down

- Swiping-in from the bottom or top edge of the display reveals the **All apps** icon . Touch **All apps** to show an alphabetical list of all applications installed on your tablet.
- Swiping-in from the top to the bottom of an app docks or closes the application.

For more information on using Windows 8 Start screen, see <http://windows.microsoft.com/en-US/windows-8/get-started>.

# Using Headphones

You can use 3.5 mm headphones to listen to music and sounds, record audio, or make calls.

 **WARNING:** Listening with the loud music for extended period of time can lead to hearing loss.

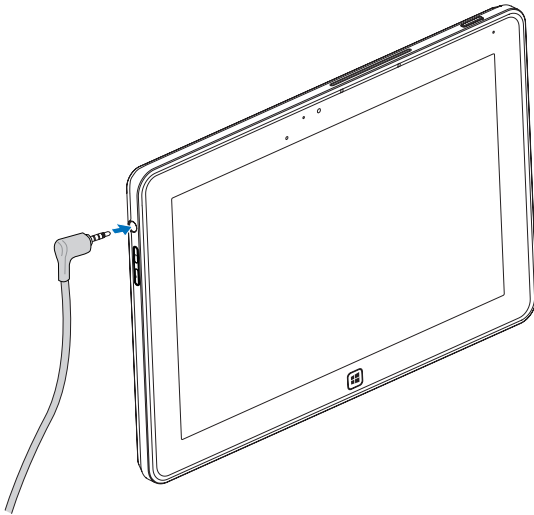

- 1 Connect headphones to the audio port (3.5 mm) on the tablet.
- 2 Insert the earphones in your ears and adjust the volume level to a comfortable level.

 **NOTE:** When you connect an audio device to the 3.5 mm audio jack, the integrated speakers on your tablet are muted automatically.

 **CAUTION:** To prevent damage to the headphones when disconnecting it from the tablet, pull the connector and not the cable.

# Managing Your Tablet Settings

## Remove the Micro-SD card

 **CAUTION:** Removing the Micro-SD card when transferring data may cause data loss or result in application errors. Make sure your tablet has finished all save operations to the Micro-SD card.



- 1 Enter the Desktop mode. Touch **Safely Remove Hardware**  in the notification area at the bottom-right corner of the screen.

 **NOTE:** If you don't see **Safely Remove Hardware** , touch **Show Hidden Icons** to display all icons in the notification area.

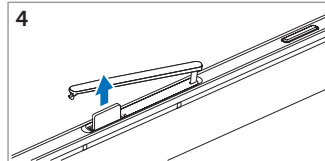
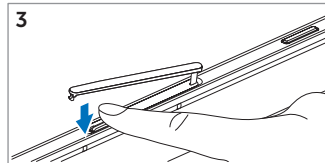
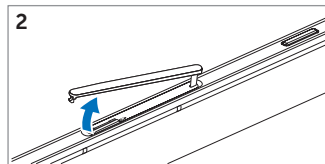
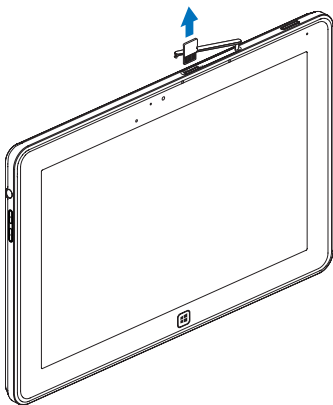
- 2 Touch **Eject SD Memory Card**. A message appears confirming that the Micro-SD card can be safely removed. If a warning message appears stating the Micro-SD card cannot be removed, ensure all data transfers involving the Micro-SD card are complete.
- 3 Open the slot cover.
- 4 Press on the inserted Micro-SD card to release the card.
- 5 Slide the card out after it pops out from the Micro-SD card slot.



## Wi-Fi setting

- Turning On/Off Wi-Fi:
  - 1 Swipe from the right edge of the display to access Charms.
  - 2 Touch **Settings**  → **Change PC settings** → **Wireless**.
  - 3 Swipe **Wi-Fi** icon left or right to turn Wi-Fi on or off.
- Connecting to a network:
  - 1 Swipe from the right edge of the display to access Charms.
  - 2 Touch **Settings**  → **Available**  → **Select an available network** → **Connect**.

## Refresh your tablet

Refreshing your tablet will restore the system to original factory settings without deleting any of your personal files, installed apps from Windows Store or personalization settings.

- 1 Swipe from the right edge of the display to access Charms.
- 2 Touch **Settings**  → **Change PC settings** → **General** → **Refresh your PC without affecting your files**.
- 3 Touch **Get started**.
- 4 Touch **Next** after you read the warning.





**NOTE:** Third-party apps will be removed.



## Reset your tablet

Resetting your tablet will return the system to original factory settings.

- 1 Swipe from the right edge of the display to access Charms.
- 2 Touch **Settings**  → **Change PC settings** → **General** → **Reset your PC and start over**.
- 3 Touch **Get started**.
- 4 Touch **Next** after you read the warning.

 **CAUTION:** Resetting your tablet erases all data from your tablet, including your account configuration, music, pictures, files, and so on. Ensure that you back up all the required data before you proceed.

## Recover your tablet

If your tablet will not boot into Windows 8 RT, you may need to perform recovery procedures.

- 1 Turn off your tablet. For more information on turning off your tablet, see [Turning Off Your Tablet](#).
- 2 Press and hold the **Volume-up** button and then press the **Power and Sleep/Wake** button  to turn on the tablet.
- 3 Release the **Volume-up** button when "Attempting to boot from Windows Recovery..." is displayed on the upper left corner of the display.
- 4 Follow the on-screen instructions to refresh or reset your tablet.



# Synchronizing Your Tablet

## Use Microsoft account

If your computer has Microsoft Windows 8 installed, you can synchronize user settings of your tablet with your computer using a Microsoft account. When you sign in with your Microsoft account on your tablet, you can automatically synchronize your settings, including internet browser history, application settings, and personal files etc., with other Windows 8 PCs and tablets.



**NOTE:** You need a wireless connection for both your computer and tablet.

- 1 Go to Charms, then click **Settings**  → **PC Settings** → **Users** → **Switch to a Microsoft account** to switch your computer local account to your Microsoft account.
- 2 An new option will be added to **PC Settings** called **Sync your settings**.
- 3 Click **Settings**  → **PC Settings** → **More PC Settings** → **Sync your settings** to show all kind of toggles for synchronizing your data and settings.

## Copy music, photos, and videos

- 1 Connect your tablet to a computer using the supplied Micro-USB to standard USB conversion cable.
- 2 After the copy is complete, use the **Safely Remove Hardware** wizard to remove your tablet from the computer.

# Using XPS 10 Mobile Keyboard Dock

## Mobile Keyboard Dock Features

This section provides information about the features available on the keyboard dock.

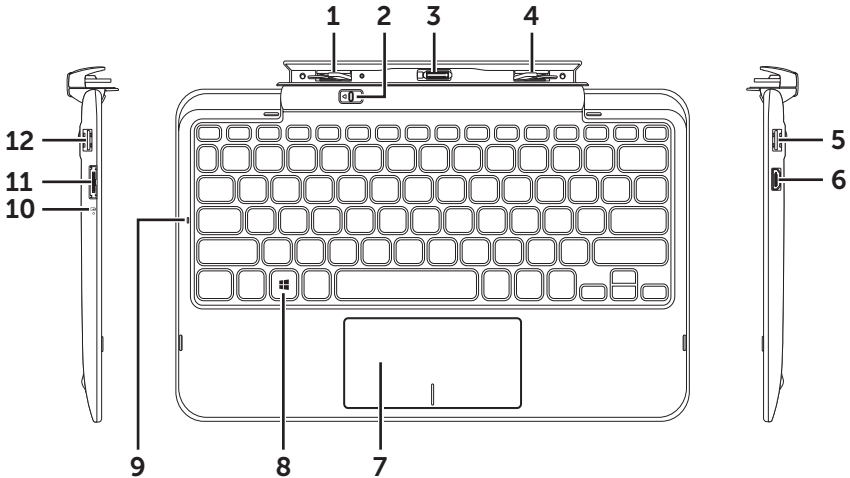

Feature	Functionality
1 Docking latch	Connect a Dell tablet.
2 Tablet release latch	Release the tablet from the keyboard dock.
3 Docking connector	Connect the power-adaptor/docking port on the tablet.
4 Docking latch	Connect a Dell tablet.
5 USB 2.0 port	Connect USB devices, such as flash memory.
6 Mini-HDMI port	Connect devices supporting audio/video signals in HDMI format.
7 Touchpad and touchpad buttons	Allows you to move the mouse pointer on the screen and provides the function of a mouse.

Feature	Functionality
8 Windows key	<ul style="list-style-type: none"> <li>• Press to open the Windows Start screen.</li> <li>• Press for quick access to the most recently used application or most recently viewed screen.</li> </ul>
9 Caps-lock light	Indicates that caps lock is active.
10 Battery-charge light	Indicates the battery charge status.
11 Power-adaptor port	Connect the supplied power adapter to provide power to the tablet and dock, and charge the battery.
12 USB 2.0 port	Connect USB devices, such as flash memory.



**NOTE:** The keyboard dock is sold separately and is not shipped with the tablet.

Regulatory model: K05M

# Docking Your Tablet to the Keyboard Dock

- 1 Remove the two docking-port covers from the tablet.

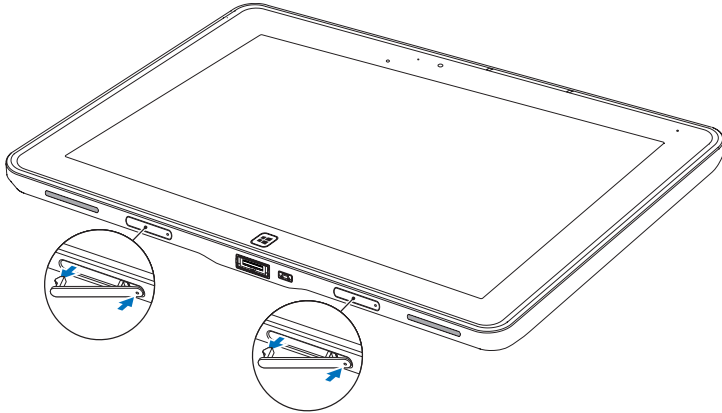



- 2 Align the power-adaptor/docking port on the tablet with the 40-pin docking connector on the keyboard dock. Or, center the **Windows** button to the painted line on the front of the hinge holder.

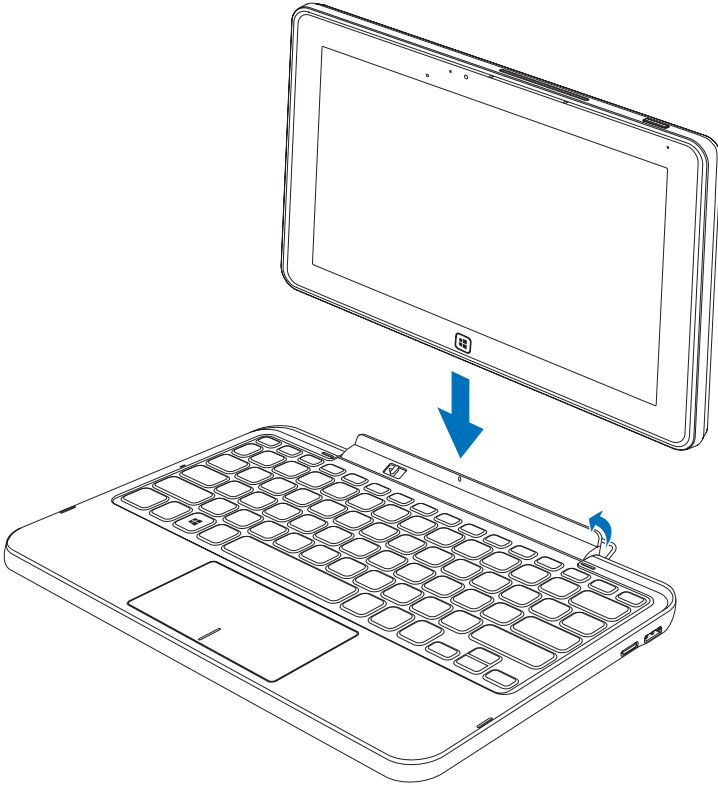

**NOTE:** The hinge holder can be rotated manually to a better position for easy docking.

- 3 Slide the tablet downward until the tablet clicks into place. When the tablet is correctly connected, the tablet-release latch on the dock will move to the *Locked* position.



 **NOTE:** When the connection is made, you need to manually turn the on-screen keyboard off if it is displayed on the screen.

 **NOTE:** You can reinstall the docking-port covers when the tablet is not docked.

# Undocking Your Tablet from the Keyboard Dock

- 1 Slide and hold the tablet-release latch to the *Unlock* position.
- 2 Lift the tablet from the keyboard dock.

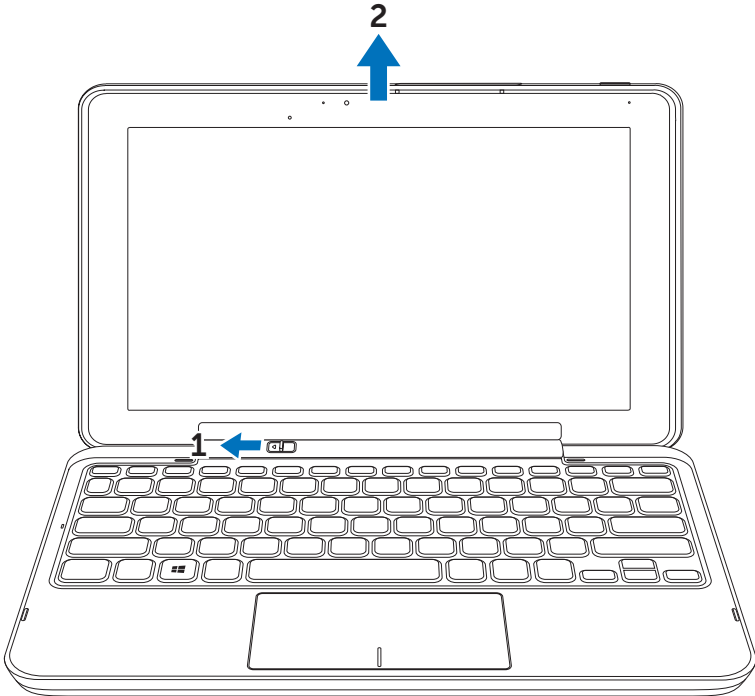

**NOTE:** The release latch will automatically move to the *Locked* position once the tablet is removed from the keyboard dock.

# Charging the tablet and dock

**⚠ CAUTION:** Use only the supplied power adapter and power cable to charge your tablet and dock. Using unauthorized power adapters or power cables may cause severe damage to your tablet and dock.

- 1** Connect the power adapter to the 40-pin power-adapter port on your keyboard dock.

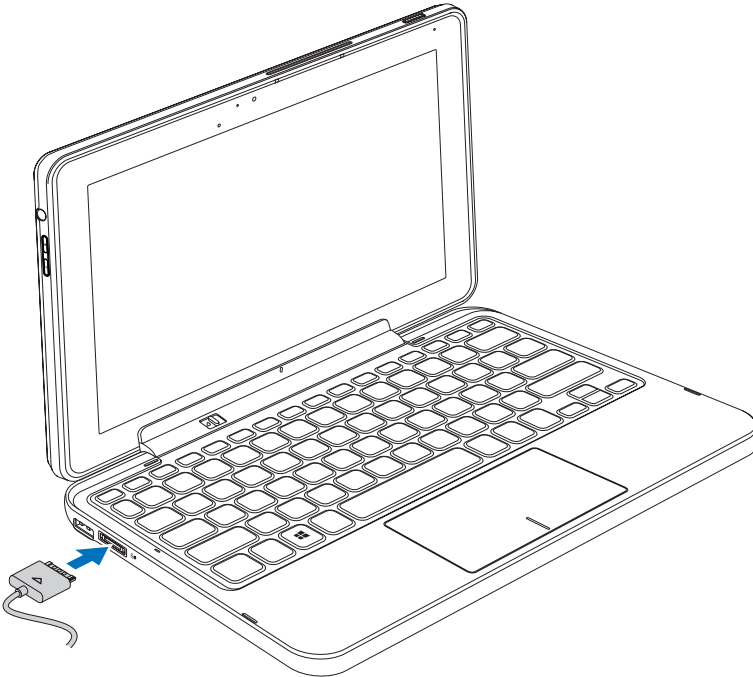

- 2** Connect the power adapter to an electrical outlet and charge the tablet and dock until the battery is fully charged.

**✍ NOTE:** The dock battery requires about 4 hours to fully charge.

For more information on the tablet battery charging time, see [Charging the tablet](#).



You can check the keyboard dock battery status from:

- Battery-charge light located on the left side of the keyboard dock:

<b>LED behavior</b>	<b>Description</b>
Solid white color on	Battery is charging with AC.
Off	Battery is not charging, either no AC is connected or battery is fully charged.

For more information on checking the tablet battery status, see [tablet battery charge status](#).

## Battery behavior

When using your tablet, you may encounter the following 4 scenarios concerning the battery behavior.

Conditions	Tablet battery behavior	Dock battery behavior
1 Power adapter is connected to the dock.	Charges both the tablet and dock battery.	Charges both the tablet and dock battery.
2 Power adapter is not connected. Both the tablet and dock have battery capacity.	Tablet uses its own battery to support the tablet functions.	Dock uses its own battery to support the dock functions (e.g. speakers, USB, and HDMI...etc).
3 Power adapter is not connected. The tablet has LESS than 5% battery capacity but the dock has battery capacity.	Tablet functions are supported by the dock battery. Tablet will use the last 5% of its own battery after the dock battery runs out.	Dock uses its own battery to support the dock functions (e.g. speakers, USB, and HDMI...etc).
4 Power adapter is not connected. The tablet has battery capacity but the dock has NO battery capacity.	Tablet uses its own battery to support the tablet functions, but does not support any dock functions.	Dock functions are disabled (e.g. keypad, touchpad, speakers, USB, and HDMI...etc). User does not receive indication of the dock status.





**NOTE:** When the tablet has battery capacity and the dock has no battery capacity, the tablet functions normally, but the dock cannot perform any functions. You can undock the tablet from the keyboard dock and continue to use the tablet until the battery is depleted.

# Cleaning Your Tablet

 **CAUTION:** Before you clean your tablet, disconnect all the cables. Clean your tablet with a soft cloth dampened with water. Do not use liquid or aerosol cleaners, which may contain flammable substances.

- 1 Turn off your tablet. For more information on turning off your tablet, see [Turning Off Your Tablet](#).
- 2 Disconnect any attached devices, headphones, speakers and keyboard dock from the tablet and from their electrical outlets.
- 3 Remove any installed Micro-SD card. For more information on removing the Micro-SD card, see [Remove the Micro-SD card](#).
- 4 Moisten a soft, lint-free cloth with either water or a display cleaner, and wipe the surface of the tablet until it is clean. Do not allow water from the cloth to seep down to the tablet ports and the surrounding **Windows** button.

 **NOTE:** To avoid damaging the tablet or display, do not spray cleaning solution directly onto the display. Only use products specifically designed for cleaning displays, and follow the instructions that are included with the product.

 **NOTE:** Do not clean the keyboard with a moist cloth.

# Troubleshooting

## Battery problem

Problems	Possible causes	Possible solutions
Battery does not charge		<ol style="list-style-type: none"> <li><b>1</b> Unplug the supplied Dell AC power adapter from the wall and verify that the outlet is functioning.</li> <li><b>2</b> Check all cable connections and plug back into the wall, then back into the tablet.</li> <li><b>3</b> Check all connectors to ensure proper connectivity.</li> </ol>
	The tablet's temperature is below 0 °C or higher than 35 °C.	Charge the battery in an ambient temperature between 0 °C to 35 °C.
	The battery or power adapter is damaged.	Contact a Dell authorized reseller to replace the battery or power adapter.
Battery drains quickly even when the tablet is in Standby mode	If the tablet is not in the range of a network it can connect to, the tablet continues to send out signals to locate a base station and drains the battery.	<ul style="list-style-type: none"> <li>• Temporarily turn off the tablet.</li> <li>• Move the tablet in range of a network it can connect to, or temporarily turn off the wireless connection on your tablet.</li> </ul>

## System problem

Problems	Possible causes	Possible solutions
Tablet does not turn on	The battery is completely discharged.	<ol style="list-style-type: none"> <li>1 Charge the tablet for at least 4 hours.</li> <li>2 Press and hold the Power and Sleep/Wake button for 4 seconds.</li> </ol>
Tablet does not turn off		Press and hold the Power and Sleep/Wake button for 11 seconds to perform a hard shut down.
Tablet locks up		Press and hold the Power and Sleep/Wake button for 11 seconds to perform a hard shut down.
Tablet is not responding or behaving unexpectedly		<ol style="list-style-type: none"> <li>1 Reboot the tablet. See <a href="#">Turning Off Your Tablet</a> and <a href="#">Turning On Your Tablet</a>.</li> <li>2 Refresh the tablet. See <a href="#">Reset your tablet</a>.</li> <li>3 Contact Dell's support service. Go to <a href="http://support.dell.com">support.dell.com</a> or <a href="http://dell.com/ContactDell">dell.com/ContactDell</a>.</li> </ol>
Tablet cannot boot into Windows		Boot from Windows recovery. See <a href="#">Recover your tablet</a> .
Software or feature is not working as expected		Restart your tablet. Software updates may have been downloaded in the background. Swipe from the right edge of the display to access Charms and touch <b>Settings</b> → <b>Power</b> → <b>Restart</b> to restart the tablet.

## Touchscreen problem

Problems	Possible causes	Possible solutions
Touchscreen responds slowly or improperly	Protective cover prevents the tablet from recognizing your inputs.	<ul style="list-style-type: none"><li>• Gently wipe the display with a clean dry cloth.</li><li>• Remove any protective covers from the touchscreen.</li></ul>

## Network Problem

Problems	Possible causes	Possible solutions
No wireless connection		<ol style="list-style-type: none"><li><b>1</b> Check if the wireless radio is on. See <a href="#">Wi-Fi setting</a>.</li><li><b>2</b> Try to get closer to the wireless access point.</li><li><b>3</b> Reset the wireless router if using a private network; open the browser to view the landing page if using a public network.</li></ol>
Slow Internet connections	The signal strength is not strong enough.	Move your tablet to a different location for better signal reception.



# Specifications

## Physical dimensions

Height	9.2 mm (0.36 inches)
Width	274.7 mm (10.81 inches)
Depth	177.3 mm (6.98 inches)
Weight	623~633g (1.37~1.39 lb)

## Environmental requirements

Temperature range:	
Operating	0° to 35 °C (32° to 95 °F)
Non-operating	-40° to 65 °C (-40° to 149 °F)
Relative humidity (maximum):	
Operating	10% to 90% (noncondensing)
Non-operating	5% to 95% (noncondensing)
Maximum vibration (using a random vibration spectrum that simulates user environment):	
Operating	20 GRMS
	0.66 GRMS (tablet + dock)
Non-operating	1.30 GRMS
Maximum shock	
Operating	60 G
	140 G (tablet + dock)
Non-operating	120 G
	163 G (tablet + dock)
Altitude (maximum, unpressurized):	
Operating	-15.2 to 3048 m (-50 to 10,000 ft)
Storage	-15.2 to 10,668 m (-50 to 35,000 ft)
Airborne containment level	G2 or lower as defined by ISA-S7 1.04-1985



## Touchscreen display

Type	10.1" WXGA with multi-point capacitive touch
Maximum resolution	1366 × 768 HD
Aspect ratio	16:9
Brightness	360 nits
Viewing angle	Symmetrical 85 degrees
Contrast ratio	800:1
Color depth	24 bit/pixel

## Ports and Connectors

Audio	One microphone/stereo headphone/speakers port
Micro-SD card	One micro-SD card slot
Dock	One 40-pin power-adapter/docking port
USB	One micro-USB port

## AC Adapter

Input voltage	100-240 VAC
Input current (maximum)	1.0 A
Input frequency	50-60 Hz
Output power	30 W
Output current	19 V
Rated output voltage	+19.5 VDC
Temperature range:	
Operating	0° to 40°C (32° to 104 °F)
Storage	-40° to 70 °C (-40° to 158 °F)

# Glossary

This section provides information about the terms used in this document that is for informational purposes only and may or may not describe features included with your tablet.

## A

**A** - ampere - A measure of the amount of electric charge passing a point in an electric circuit.

**AC** - alternating current - The form of electricity that powers your tablet when you plug the AC adapter power cable in to an electrical outlet.

**ambient light sensor** - A feature that helps to control the display brightness.

## C

**Charms** - a Microsoft Windows 8 term for the icons that appear when you swipe from the right edge of the display. It provides quick access to the commonly system commands, including search, share, Start, devices and settings options.

## D

**device** - Hardware such as a disk drive, printer, or keyboard that is installed in or connected to your tablet.

## E

**Email** - Electronic mail - a method of exchanging digital messages from an author to one or more recipients via the Internet. Email servers accept, forward, deliver and store messages, and neither the users nor their computers are required to be online simultaneously.

## G

**GRMS** - A unit of acceleration caused by the force of gravity. The grms value is typically used to express the overall energy of a particular random vibration event and is a statistical value used in mechanical engineering for structural design and analysis purposes.

## H

**HDMI** - High-Definition Multimedia Interface - A compact audio/video interface for transferring uncompressed digital audio/video data from an HDMI-compliant device. Mini-HDMI is smaller than standard HDMI plug connector. The Mini-HDMI port can be connected to a standard HDMI port using Mini-HDMI to HDMI cable.

**Hz** - Hertz - A unit of frequency measurement that equals 1 cycle per second. Computers and electronic devices are often measured in kilohertz (KHz), megahertz (MHz), gigahertz (GHz), or terahertz (THz).

## K

**keyboard dock** - provides the docking feature to adapt your tablet to a laptop workspace.

## M

**Micro-SD** - micro-Secure Digital - a smaller size of SD which is a removable flash memory card used for storing information in portable devices, such as mobile phones, digital cameras, and tablet computers. The standard size of SD is 32 x 24 x 2.1 mm and Micro-SD is 15 x 11 x 1 mm.

**Micro-USB** - universal serial bus - A hardware interface for a low-speed device such as a USB-compatible scanner, set of speakers, printer, broadband devices, imaging devices, or storage devices. Devices are plugged directly in to a 5-pin socket on your tablet, both to communicate and to supply electric power. The Micro-USB port can be connected to a standard USB port using Micro-USB to USB cable.

## R

**resolution** - The sharpness and clarity of an image produced by a printer or displayed on a monitor. The higher the resolution, the sharper the image.

## S

**Service Tag** - A bar code label on your tablet that identifies your tablet when you call Dell for customer service or technical support.

**Skype** - A proprietary voice-over-Internet Protocol (VoIP) service and software application allows user to communicate with peers by voice, voice, and instant messaging over the Internet. Calls to other users within the Skype service are free of charge, while calls to landline telephones and mobile phones are charged via a debit-based user account system.

**shortcut** - An icon that provides quick access to frequently used programs, files, folders, and drives. When you place a shortcut on your Windows Start screen, the home screen of Windows 8 is made up of 'Live Tiles', and touch the tile, you can open its corresponding folder or file without having to find it first. Shortcut tiles do not change the location of files.

**sleep mode** - A power management mode that shuts down all unnecessary computer operations to save energy.

## V

**V** - volt - The measurement of electric potential or electromotive force. One V appears across a resistance of one ohm when a current of one ampere flows through that resistance.

**VAC** - voltage in alternating current - A mathematics of AC voltages, as alternating currents are caused by alternating voltages.

**VDC** - voltage in direct current - A measurement in a DC system. The current flows directly, in one direction in the circuit, and flows at a specific, constant voltage.

## **W**

**W** - watt - The measurement of electrical power. One W is 1 ampere of current flowing at 1 volt.

**wallpaper** - The background pattern or picture on the Windows desktop.

**Wi-Fi** - A technology as a synonym for WLAN (wireless local area network) connects to the Internet when within range of a wireless network.

**WXGA** - wide-aspect extended graphics array - A video standard for video cards and controllers that supports resolutions up to 1280 x 800.

# Index

## A

### Accessory

- Micro-USB to USB cable, 10
- Mini-HDMI to HDMI cable, 10
- Power adapter, 10
- Power cable, 10

## B

### Battery

- Keyboard dock charge, 32
- Tablet battery status, 13
- Tablet charge, 12

### Button

- Power and Sleep/Wake, 6
- Volume up/down, 7
- Windows, 6

## C

### Charging

- Keyboard dock, 32
- Tablet, 12

### Charms, 21

### Connection

- Wi-Fi, 24

## G

### Gestures

- Drag, 18
- Rotate, 19

Swipe or Slide, 18

Touch, 17

Touch and Hold, 18

Zoom in, 19

Zoom out, 19

## K

### Keyboard Dock

- Charge, 32
- Docking tablet, 29
- Overview, 27
- Undocking tablet, 31

## L

Lock screen, 14

Login screen, 14

## M

### Micro-SD card

- Insert, 16
- Remove, 23

## S

### Screen

Lock screen, 14

Login screen, 14

Swipe left, 21

Swipe right, 21

Swipe up/down, 21

- Turn off/on, 15
- Service tag
  - Locating, 39
- Start icon
  - Function, 21
- Synchronize with computer, 26

## **T**

- Tablet
  - Charge, 12
  - Overview, 5
  - Refresh, 24
  - Reset, 25
  - Setting, 11
  - Turn off, 15
  - Turn on, 14
- Touchscreen Display
  - Orientation, 17
  - Turn off/on, 15
- Troubleshooting
  - Battery, 36
  - Network, 38
  - System, 37
  - Touchscreen, 38

## **W**

- Wi-Fi setting, 24
- Windows Start screen, 20
- Windows button
  - Function, 6
  - Location, 5