



# HUAWEI *Ascend* W1

User Guide



Welcome to HUAWEI

# Contents

Safety Precautions .....	1
Foreword .....	3
Getting started .....	4
Getting to know your phone .....	4
Installation .....	5
Charging the battery .....	6
Battery saving tips .....	6
Powering your phone on and off .....	7
Setting up your phone for the first time .....	8
Gestures .....	8
Getting to know your screen .....	10
Status icons .....	10
Opening an application .....	11
Locking the screen .....	12
Unlocking the screen .....	12
Texting .....	12
Editing text .....	14
Personalizing your phone .....	15
Pinning tiles .....	15
Resizing tiles .....	15
Moving tiles .....	16
Unpinning tiles .....	17
Changing the theme .....	18
Changing the lock screen background .....	18
Setting a ringtone .....	18
Adjusting the screen brightness .....	18
Setting a screen timeout period .....	19
Screen lock .....	19
Calls .....	20
Making a call .....	20
Making emergency calls .....	20
Viewing missed calls and returning them .....	20
Answering or rejecting a call .....	21
Making a conference call .....	21
Inviting more people to a conference call .....	21
Having a private conversation .....	21
Call forwarding .....	21
Setting up your voicemail .....	22
Using voice dialing to call a contact .....	22
People .....	23

Adding an account.....	23
Creating a contact.....	23
Importing contacts using Bluetooth.....	24
Importing contacts from a SIM card.....	24
Editing a contact.....	24
Searching for a contact.....	24
Deleting a contact.....	25
Sharing a contact.....	25
Linking contacts.....	25
Unlinking a contact.....	26
Filtering your contact list.....	26
Creating a room.....	26
Editing a room.....	27
Creating a contact group.....	27
Editing a contact group.....	28
Deleting a contact group.....	28
<b>Internet connection.....</b>	<b>29</b>
Turning on mobile data connection.....	29
Adding an APN.....	29
Turning on data roaming.....	29
Connecting to a WLAN.....	30
Connecting to a hidden WLAN.....	30
Turning off mobile data connection.....	30
Turning WLAN off.....	31
<b>Surfing the web.....</b>	<b>32</b>
Browser.....	32
Adding a website to your favorites.....	33
Accessing your favorites.....	33
Deleting your favorites.....	33
Editing your favorites.....	33
Clearing your browser history.....	33
<b>Sharing.....</b>	<b>35</b>
Turning on Bluetooth.....	35
Sharing files using Bluetooth.....	35
Copying files to and from your computer.....	35
<b>Messaging.....</b>	<b>37</b>
Sending a text message.....	37
Sending a multimedia message.....	37
Chatting online.....	38
Viewing a thread.....	38
Sending a text message to a contact group.....	38
Deleting a message.....	39
<b>Email.....</b>	<b>40</b>
Adding an email account.....	40

Checking emails .....	40
Sending an email.....	40
Deleting an email .....	41
Modifying email account settings.....	41
Linking mailboxes into one .....	41
Unlinking mailboxes .....	42
<b>Camera .....</b>	<b>43</b>
Taking a photo.....	44
Shooting a video .....	44
<b>Photos hub.....</b>	<b>45</b>
Viewing photos.....	45
Marking a photo as your favorite.....	46
Sharing photos and videos .....	46
Changing the Photos hub background .....	46
<b>Entertainment .....</b>	<b>47</b>
Listening to music .....	47
Watching videos.....	48
<b>Navigation.....</b>	<b>49</b>
Turning on GPS.....	49
Browsing the map .....	49
<b>Calendar .....</b>	<b>50</b>
Viewing the calendar.....	50
Viewing your agenda .....	50
Adding an appointment .....	50
Adding a to-do task .....	51
<b>Alarms .....</b>	<b>52</b>
Adding an alarm .....	52
Turning on and off an alarm.....	52
Deleting an alarm.....	52
<b>Office .....</b>	<b>53</b>
Creating and editing a Word document .....	53
Creating and editing an Excel workbook .....	53
Viewing and editing a PowerPoint presentation.....	54
Saving a file to Windows Live SkyDrive .....	54
<b>Applications .....</b>	<b>55</b>
Downloading applications .....	55
Installing applications from the Store.....	55
Uninstalling applications.....	55
<b>Phone settings.....</b>	<b>56</b>
Traffic manager.....	56

Setting the time zone and language .....	56
Checking your phone storage.....	56
Backup.....	56
Phone finder .....	57
FAQs .....	58
For more help.....	60
Personal information and data security .....	61
Legal Notice .....	62

# Safety Precautions

Please read the safety precautions carefully to ensure the correct use of your mobile phone.



Do not crash, throw, or puncture your mobile phone. Avoid the falling, squeezing, and bending of your mobile phone.



Do not use your mobile phone in a moist environment, such as the bathroom. Prevent your mobile phone from being soaked or washed in liquid.



Do not switch on your mobile phone when it is prohibited to use phones or when the phone may cause interference or danger.



Do not use your mobile phone while driving.



Follow any rules or regulations in hospitals and health care facilities. Switch off your mobile phone near medical apparatus.



Switch off your mobile phone in aircraft. The phone may cause interference to control equipment of the aircraft.



Switch off your mobile phone near high-precision electronic devices. The phone may affect the performance of these devices.



Do not attempt to disassemble your mobile phone or its accessories. Only qualified personnel are allowed to service or repair the phone.



Do not place your mobile phone or its accessories in containers with a strong electromagnetic field.



Do not place magnetic storage media near your mobile phone. Radiation from the phone may erase the information stored on them.



Do not put your mobile phone in a high-temperature place or use it in a place with flammable gas such as a gas station.



Keep your mobile phone and its accessories away from children. Do not allow children to use your mobile phone without guidance.



Use only approved batteries and chargers to avoid the risk of explosions.



Observe any laws or regulations on the use of wireless devices. Respect others' privacy and legal rights when using your wireless device.



Strictly follow the relevant instructions of this manual while using the USB cable. Otherwise your mobile phone or PC may be damaged.

# Foreword

Thank you for choosing the HUAWEI W1 smartphone.

With HUAWEI W1, you can:

- Enjoy new Windows features right in the palm of your hand.
- Surf the Internet at lightening-fast speeds.
- Immerse yourself in an extraordinary audio experience.
- Take photos and record videos anytime, anywhere.
- A lot more

Now start exploring the amazing new world of HUAWEI W1!



All pictures and illustrations in this document are for your reference only.  
The actual product may vary.



# Getting started

## Getting to know your phone

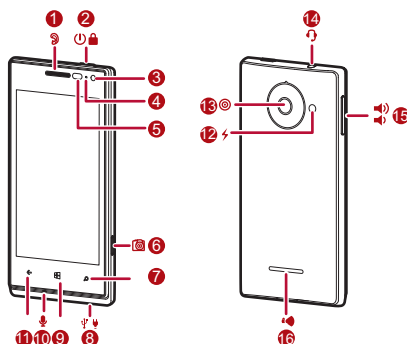



1	Earpiece	2	Power button
3	Front camera	4	Status indicator
5	Proximity sensor	6	Camera button
7	Search button	8	Micro USB port
9	Start screen button	10	Microphone
11	Back button	12	Flashlight
13	Rear camera	14	Headset jack
15	Volume button	16	Speaker

### Button functions

#### Back button

- Tap ← to return to the previous screen.
- Tap and hold ← to display recently used applications.

---

	<ul style="list-style-type: none"> <li>• Tap  to display the Start screen.</li> <li>• Tap and hold  to open the voice controller. You can then give voice commands to your phone. For example, to call a number, simply tell the phone which digits to dial.</li> </ul>
Start screen button	

---

Search button	Tap  to open Bing search.
---------------	--

---

## Installation

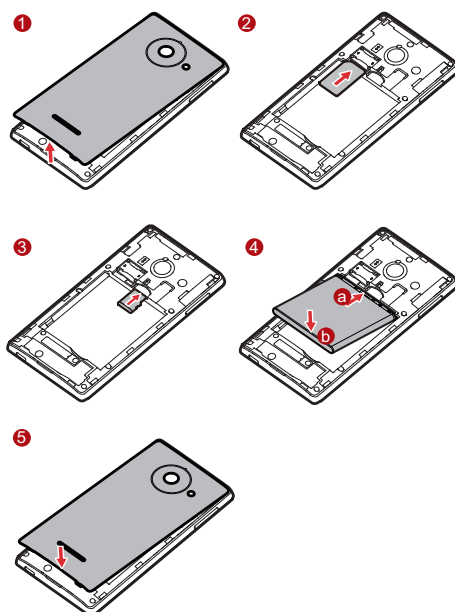

1. Open the battery cover.
2. Install the SIM card.  
Insert the SIM card into the SIM card slot with its metal contacts facing down.
3. Install the microSD card.  
Insert the microSD card into the microSD card slot with its metal contacts facing down.

#### 4. Install the battery.

Align the battery's metal contacts with those at the top of the battery compartment (refer to position a in the preceding figure). Then press the other end of the battery (position b in the preceding figure) to fix it to the battery compartment.

#### 5. Close the battery cover.

## 💧 Charging the battery

Before you charge the battery, ensure that it is correctly installed in your phone.

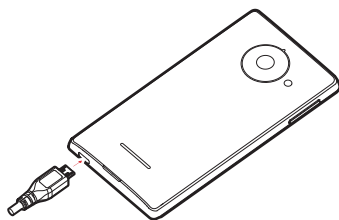













1. Connect your charger to the provided USB cable.
2. Connect the charger to a power outlet.
3. Connect your phone to the USB cable to start charging the battery.

The status indicator shows your phone's battery level:

- **Blinking red:** The battery level is low, and the phone needs to be charged immediately.
- **Steady red:** Your phone is charging.
- **Steady green:** Your phone is charging, and the battery level is high or full.

## 💧 Battery saving tips

- **Enable power saver.**  
Tap  > **battery saver**. Switch **Battery Saver** to on .
- **Set the screen timeout period to a small value.**  
Tap  > **lock screen**. Set the screen timeout period to a small value.

- Set the screen brightness to a low value.  
Tap  > **brightness**. Switch automatic adjustment to **off** .
- Set the phone volume to a low value.  
Press the volume button to lower the volume.  
Tap  > **ringtones + sounds**. Follow the onscreen instructions to disable unwanted sounds, such as keytones and touch sounds.  
To conserve battery power, use a headset to make calls or listen to music.
- Turn off Bluetooth.  
Tap  > **Bluetooth**. Switch Bluetooth to **off** .
- Turn off WLAN.  
Tap  > **WLAN**. Switch WLAN to **off** .
- Turn off GPS.  
Tap  > **location**. Switch GPS to **off** .

## 💧 Powering your phone on and off

### Powering on

Press and hold the power button until your phone vibrates.

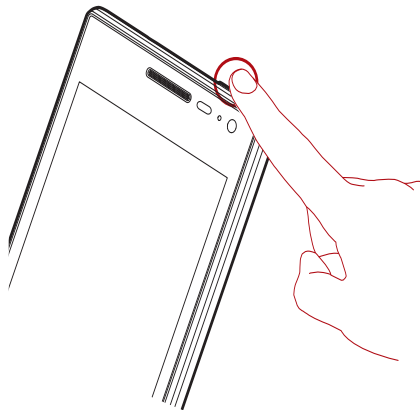

- 📄 When you use your phone for the first time or you have not used it in a long time, it may not power on because the battery level is too low. Charge your phone for a while before you attempt to power it on.

## Powering off

Press and hold the power button until the **slide down to power off** message is displayed on the screen. Slide your finger down the screen to power off your phone.



## ◆ Setting up your phone for the first time

When you use your phone for the first time, follow the onscreen instructions to set its language, time, and more.

You will be prompted to register or sign in to your Microsoft account. After you sign in, you can access Microsoft services, such as contact management and application store. You can also skip this step now and sign in later.

## ◆ Gestures

The following simple gestures make it easy to use your phone.



**Tap:** Tap to select an item or open an application.

---



**Double-tap:** Quickly tap the screen twice to zoom in.

---



**Tap and hold:** Tap and leave your finger on the screen for a moment until an option menu is displayed.

---



**Flick:** Where applicable, swipe your finger in the direction you want the screen to move to scroll rapidly through menus or pages.

---



**Drag:** Touch and hold an item and then drag it to another position.

---



**Pinch and stretch:** Pinch two fingers together to zoom out or stretch them apart to zoom in on a map, web page, or picture.

---

## Getting to know your screen

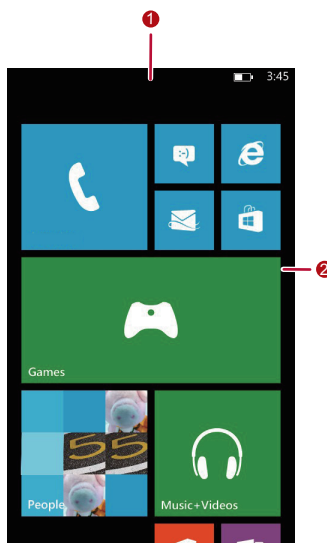

- 
- 1 Status bar: displays information such as the time, network connection status, signal strength, and battery level.

- Flick down to view more status icons.

- 
- 2 Main display area: displays application icons and their updates.





- Tap a tile to open the application.
- Tap and hold a tile to resize or delete it.

---













## Status icons

The following status icons may appear on your phone's status bar.

---

	Airplane mode enabled		Charging
	Battery low		Battery full

---

	Battery saver mode enabled		Bluetooth on
	No signal		Signal strength extremely low
	Signal strength high		Charging completed
	Silence mode enabled		SIM card locked
	No SIM card found		Vibration mode enabled
	WLAN enabled but not connected to a WLAN		Connected to a WLAN

## 🔹 Opening an application

On the Start screen, flick left to display the application list. Tap the desired application to open it.



All of your applications are listed in an alphabetical order. If you have lots of applications and want to find one quickly, tap  and enter the application name.



 For applications pinned to the Start screen, tap an icon to open the application.



## ◆ Locking the screen

When you are not using your phone, press the power button to lock the screen.

You can also set a screen timeout period and have your phone automatically lock its screen after being idle for the set period.

 In the application list, tap  > **lock screen** > **Screen times out after**. Set the desired screen timeout period.

## ◆ Unlocking the screen

Press the power button to wake the screen. Then flick up to unlock it.

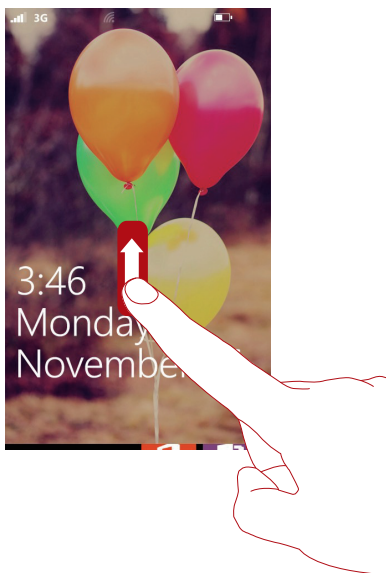

## ◆ Texting

Your phone features the Microsoft QWERTY keyboard, which lets you enter text quickly.

 The keyboard layout varies depending on the scenario. The following figure is provided for your reference only.



- 
- 1 Switch between uppercase and lowercase.
  - 2 Switch to the number and symbol keyboard.
  - 3 Tap and hold to select an input language.
  - 4 Enter a space.
  - 5 Start a new line.
  - 6 Delete the character to the left of the cursor.
- 

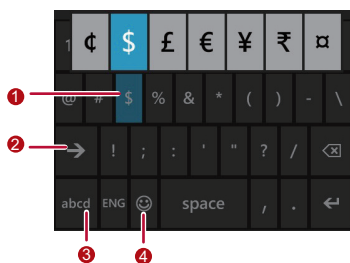



- 
- 1
    - Enter a character.
    - Tap and hold to display more characters like this.
  - 2 Switch to the next number and symbol screen.
  - 3 Switch to letter input mode.
  - 4 Enter an emoticon.
- 

 If the onscreen keyboard blocks any operation buttons, tap  to hide

the onscreen keyboard.

## ◆ Editing text

Your onscreen keyboard makes it easy to copy and paste text.

1. Tap the text you wish to copy.
2. Drag the grab points  to select more or less text.
3. Tap  to copy the selected text.
4. Tap the location where you wish to paste the text.
5. Tap  to paste the copied text.

# Personalizing your phone

Want to see your favorite photo on the lock screen? Want to pin your favorite applications to the Start screen? You'll enjoy how much you can personalize your phone.

## Pinning tiles

Pin your frequent contacts, commonly used applications, songs, and emails to the Start screen. You are what you pin after all.

### Pinning an application

In the application list, tap and hold the application you wish to pin. From the displayed option menu, tap **pin to start**.

### Pinning a contact







In the contact list, tap the contact you wish to pin and tap .

## Resizing tiles

You can resize the tiles pinned to the Start screen.

1. Tap and hold the tile you wish to resize until it enlarges.
2. Tap the arrow icon in the lower right corner of the tile.

The tiles on the Start screen come in three sizes: small, medium, and large. The arrow icon that appears on a tile depends on the tile size.

- If a tile is small,  appears in the lower right corner of the tile. You can tap  to enlarge the tile.
- If a tile is medium in size,  appears in the lower right corner of the tile. You can tap  to shrink the tile.
- If a tile is large,  appears in the lower right corner of the tile. You can tap  to shrink the tile.

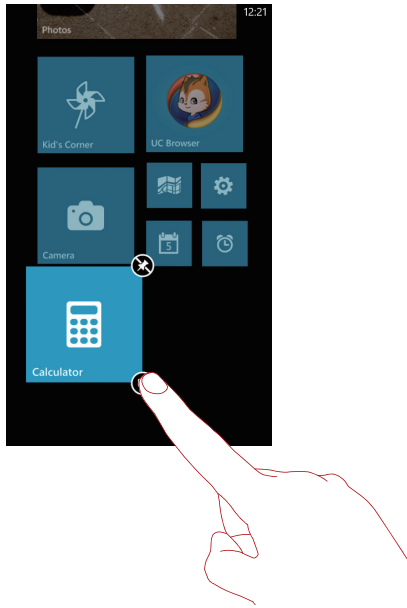

## ◆ Moving tiles

You can move tiles to customize the Start screen.

1. Tap and hold the tile you wish to move until it enlarges.
2. Drag the tile to the desired position and tap .

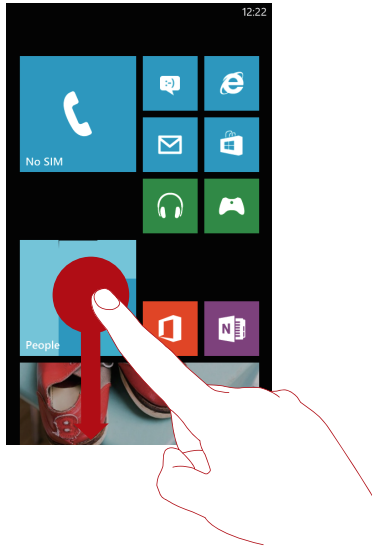

## ◆ Unpinning tiles

1. Tap and hold the tile you wish to unpin until it enlarges.
2. Tap  in the upper right corner of the tile.

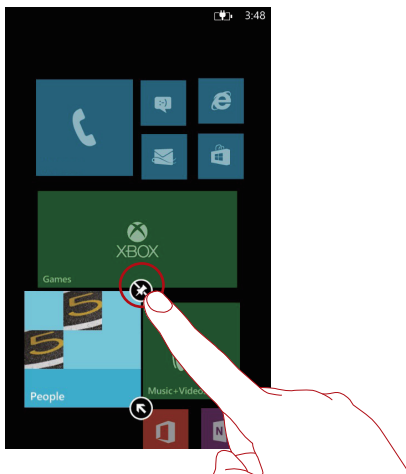

## ◆ Changing the theme

You can change your phone's background and accent colors.

In the application list, tap  > **theme**.

- Tap the **Background** box to choose a background color.
- Tap the **Accent color** box to choose an accent color.

## ◆ Changing the lock screen background

1. In the application list, tap  > **lock screen**.

2. Tap the **Background** box then **photo** or **Bing**.

- If you tapped **photo**, tap **change photo** to choose a photo from your photo albums.
- If you tapped **Bing**, your phone shuffles through photos from Bing on your lock screen.



 Using Bing background photos requires Internet access and generates data traffic.

## ◆ Setting a ringtone

In the application list, tap  > **ringtones + sounds**. Follow the onscreen instructions to set a ringtone for your phone.

## ◆ Adjusting the screen brightness

In the application list, tap  > **brightness**.

- You can switch automatic adjustment to **on**  to have your phone automatically adjust its screen brightness.
- Alternatively, you can switch automatic adjustment to **off**  and manually adjust the screen brightness.



## ◆ Setting a screen timeout period

1. In the application list, tap  > **lock screen**.
2. Tap the **Screen times out after** box and select the desired screen timeout period.

## ◆ Screen lock

To protect your phone from unauthorized access, set a screen lock.

 Remember your screen unlock code, which is the only code that can unlock your screen. If you forget your screen unlock code, please contact Huawei customer service personnel.

1. In the application list, tap  > **lock screen**.
2. Switch **Password** to **on** .
3. Follow the onscreen instructions to enter the screen unlock code. Then tap **done**.



To change the unlock code, tap **change password**.



# Calls

## Making a call

In the application list, tap . You can use any of the following methods to make a call:

- Tap , enter a phone number, and tap **call**.
- Tap , select the contact you wish to call, and tap the desired menu item such as **call mobile**.
- Tap a number from the call history and then tap **call number**.

## Making emergency calls

In the event of an emergency, you will still be able to make emergency calls without the use of a SIM card. However, you must still be in a coverage area.

1. From the application list, tap .

2. Tap .

If your phone does not have a SIM card inserted, tap **emergency call** on the displayed dialog box.

3. Enter an emergency number for your country or region.

4. Tap **call**.

-  Emergency calls are subject to your cellular network quality, use environment, service provider policies, and local laws and regulations. Never rely solely on your phone for critical communications when emergencies occur.

## Viewing missed calls and returning them

All your recent calls are displayed in your call history.

In the application list, tap  to display your recent calls.

Find a missed call and tap it. Then tap **call number** to return the missed call.

## ◆ Answering or rejecting a call



When a call comes in, you can:

- Tap **answer** to answer it.
- Tap **ignore** to reject it.



## ◆ Making a conference call

With your phone, making conference calls with your friends, family, and co-workers can be done in just a few easy steps.

 Before you make conference calls, make sure that you have subscribed to this service. For details, contact your service provider.

1. Call the first participant.
2. When the call is connected, tap  to call the second participant.
3. When the second call is connected, tap  to start a conference call.

## ◆ Inviting more people to a conference call

1. During a conference call, tap  to add a participant.
2. When the call is answered, tap  to add the participant to the conference call.



## ◆ Having a private conversation

During a conference call, tap  and then the desired phone number.

Your phone then places the conference call on hold while you have a private conversation. The other participants remain on the conference call. To return to the conference call, tap .

## ◆ Call forwarding

Too busy to answer all your calls with one phone? Forward them to another number and never miss an important call again!

1. In the application list, tap  > **Additional phone settings > call forwarding**.
2. Switch **Always forward**, **Forward when busy**, **Forward when unanswered**, or **Forward when unreachable** to on .
3. Enter the phone number to which you wish to forward calls and tap **OK**.

 The phone number you set appears under the call forwarding switch (**Always forward**, **Forward when busy**, **Forward when unanswered**, or **Forward when unreachable**). You can tap the phone number to change it.

## 🔹 Setting up your voicemail



In addition to forwarding calls to another phone number, you can forward calls to your voicemail and listen to them at anytime.

 Before you use voicemail, make sure that you have subscribed to this service. For details, contact your service provider.

1. In the application list, tap .
2. Drag **⋮** up. On the displayed screen, tap **settings**.
3. In the **voicemail number** box, enter your voicemail number.

## 🔹 Using voice dialing to call a contact

Your phone supports voice dialing, which enables you to call a contact by speaking their name or number into your phone.

1. In the application list, tap .
2. Tap and hold .
3. Hold the phone's microphone near your face and say a contact's name or phone number. For example, Tom or 1234567.

Voice dialing may occasionally be inaccurate. If your phone calls the wrong person, tap  to cancel the call.

# People

The People hub displays the contacts saved in your phone's memory, SIM card, and social networking service (SNS) accounts. You can also view your friends' updates and post your own status.

In the application list, tap  to enter the People hub.



## Adding an account

By adding an account to your phone, you can conveniently view this account's contacts and contact updates. You can also save contacts to existing accounts.

1. Open the People hub. Flick left or right to go to **what's new**.
2. Tap **set up account**.
3. Select an account type, such as Hotmail.
4. Enter your email address and password. Tap **sign in**.

## Creating a contact

 When you create a contact, you must specify the account to which you wish to save the contact. Therefore, before you create a contact, add at least one account to your phone. Account types you can add include Hotmail, Google, and Exchange.

1. Open the People hub. Flick left or right to go to **all**.
2. Tap .
3. If you have signed in to multiple accounts, tap the account to which you wish to save the contact.
4. Follow the onscreen instructions to enter the contact information. Then tap .
5. When done, tap .

## ◆ Importing contacts using Bluetooth

If the desired contacts are saved in a device that supports Bluetooth, you can import the contacts to your phone using Bluetooth.

 Before you import contacts, connect your phone and the desired device using Bluetooth.



1. From the application list, tap .
2. Tap the desired device name. If the desired device doesn't appear on the list, tap **choose device** to search for and connect to it.
3. Tap **start**.

## ◆ Importing contacts from a SIM card

You can copy contacts from your SIM card to your phone.

1. Open the People hub. Flick left or right to go to **all**.
2. Drag **⋮** up. On the displayed screen, tap **settings > import SIM contacts**.
3. Select the contacts you wish to import and tap **import**.

## ◆ Editing a contact

1. Open the People hub. Flick left or right to go to **all**.
2. Tap the contact you wish to edit.
3. Tap .
4. If the contact is linked to multiple accounts, select the account in which you wish to edit the contact.
5. Follow the onscreen instructions to edit the contact information. Then tap .

## ◆ Searching for a contact

1. Open the People hub. Flick left or right to go to **all**.



2. Tap .
3. Enter the contact's name.  
Search results appear as you type.

## 🔹 Deleting a contact

1. Open the People hub. Flick left or right to go to **all**.
2. Tap the contact you wish to delete.
3. Drag  up. On the displayed screen, tap **delete**.
4. If the contact is linked to multiple accounts, select the account from which you wish to delete the contact.
5. Tap **delete**.

## 🔹 Sharing a contact

You can easily share contacts with other devices.

1. Open the People hub. Flick left or right to go to **all**.
2. Tap the contact you wish to share to display the **profile** screen.
3. Drag  up. On the displayed screen, tap **share contact**.
4. Tap .
5. Select a sharing method.
6. Follow the onscreen instructions to share the contact.

The onscreen instructions vary depending on the sharing method you select.

## 🔹 Linking contacts

Do you have multiple entries for the same contact from different SNS or email accounts? You can link these entries to better manage your contacts.

1. Open the People hub. Flick left or right to go to **all**.
2. Tap the main contact you wish to link to.

3. Tap  > **choose a contact**. Select the contacts to be linked.

After you link the contacts, they are all saved to the main contact and are not displayed individually in the People hub.

## 🔹 Unlinking a contact



Unlinking a linked contact does not delete its information. When a linked contact is unlinked, it is displayed as an individual contact in its original account.

1. Open the People hub. Flick left or right to go to **all**.
2. Tap the main contact.
3. Tap .
4. Tap the contact you wish to unlink.
5. Tap **unlink**.

## 🔹 Filtering your contact list





If multiple accounts are available in your People hub, you can filter your contact list to display contacts only from specified accounts.

Filtering your contact list does not delete your contacts.

1. Open the People hub. Flick left or right to go to **all**.
2. Drag  up. On the displayed screen, tap **settings > filter my contact list**.
3. Select the check boxes of the accounts that contain the contacts you wish to display. Then tap .



## 🔹 Creating a room

You can create rooms to have group chats, share calendar events and photos, and more. Create a room and gather with your family and friends. Using a room to have group chats or sharing files generates data traffic. If you are using a mobile network, contact your service provider to choose an appropriate data plan.

1. Open the People hub. Flick left or right to go to **together**.
2. Tap  > **Room**.
3. Name the room and tap .
4. Tap .
5. Tap a friend you wish to invite. Then tap **Send** to send an invitation message.
6. Tap  to invite more people to the room.
7. When done, tap .





## Editing a room

You can rename a room or set its background.

1. Open the People hub. Flick left or right to go to **together**.
2. Tap the room you wish to edit.
3. Drag  up. On the displayed screen:
  - To add group members, tap  >  and follow the onscreen instructions.
  - To set a background for the room, tap **choose background**.
  - To rename the room, tap **rename**.

## Creating a contact group

You can create a contact group and send a message to all group members simultaneously.

1. Open the People hub. Flick left or right to go to **together**.
2. Tap  > **Group**.
3. Name the group and tap .
4. Tap  to choose a contact you wish to add to the group.
5. Tap  to add more contacts to the group.
6. When done, tap .



## ◆ Editing a contact group

You can rename a contact group and manage its members.

1. Open the People hub. Flick left or right to go to **together**.
2. Tap the group you wish to edit.
3. Drag **⋮** up. On the displayed screen:
  - To add group members, tap **👤** > **+** and follow the onscreen instructions.
  - To rename the group, tap **rename**.

## ◆ Deleting a contact group

1. Open the People hub. Flick left or right to go to **together**.
2. Tap the group you wish to delete.
3. Drag **⋮** up. On the displayed screen, tap **delete**.
4. Tap **delete**.

# Internet connection

Your phone brings you into the new age of wireless Internet surfing. Let's take a look at how this works.

You can access the Internet through a mobile network or wireless local area network (WLAN).

## Turning on mobile data connection

1. In the application list, tap  > **cellular**.

2. Switch **Data connection** to **on**.

 When you are not using mobile data connection, turn it off to avoid generating additional data traffic.

## Adding an APN

1. In the application list, tap  > **cellular** > **add internet apn**.

2. Configure the required settings.

3. When done, tap .

## Turning on data roaming

When you are roaming outside your service provider's coverage area, turn on data roaming to continue accessing the Internet with your mobile data connection.

1. In the application list, tap  > **cellular**.



2. Switch **Data connection** to **on**.

3. Switch **Data roaming options** to **roam**.

 Using your mobile data connection while roaming may result in hefty data fees. For more information, contact your service provider.





## ◆ Connecting to a WLAN

You can connect your phone to a WLAN to access the Internet. If both WLAN and mobile data connection are available, your phone preferentially accesses the Internet through the WLAN.

1. In the application list, tap  > **WLAN**.
2. Switch **WLAN** to on .
  - Your phone then searches for WLANs within range.
3. Tap a WLAN to connect to it.
  - You can connect to open WLANs directly.
  - To connect to an encrypted Wi-Fi network, enter the password when prompted.

## ◆ Connecting to a hidden WLAN

Though your phone can't automatically find WLANs whose service set identifiers (SSIDs) are hidden, you can follow these steps to connect to hidden WLANs.

1. In the application list, tap  > **WLAN**.
  2. Tap **WLAN** and switch **WLAN** to on .
  3. Tap **advanced** > .
  4. Enter an SSID and tap **add**.
    - You can connect to open WLANs directly.
    - To connect to an encrypted Wi-Fi network, enter the password when prompted.
-  Connecting to a hidden WLAN increases power consumption. Turn off WLAN when you don't need it to save battery power.



## ◆ Turning off mobile data connection

When you are not using mobile data connection, turn it off to reduce your phone's data traffic and battery consumption.

1. In the application list, tap  > **cellular**.
2. Switch **Data connection** to **off**.

## 💧 Turning WLAN off

Turn off WLAN when you don't need it to save battery power.

1. In the application list, tap  > **WLAN**.
2. Switch **WLAN** to **off** .

# 📍 Surfing the web

You can start surfing the web right away using your phone's browser and stay on the ball with up-to-date news and information. Staying connected has never been easier.

## 💧 Browser

In the application list, tap  to open the browser.

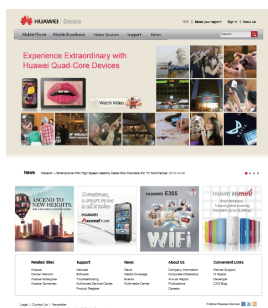

Configure the browser settings before using it for the first time.



- 1 Enter keywords or the website address you wish to visit.
- 2 Refresh the web page.
- 3 Display more options.

## ◆ Adding a website to your favorites

To conveniently access regularly visited websites, save them to your favorites.

1. Launch the browser and go to the desired website.
2. Drag  up. On the displayed screen, tap **add to favorites**.
3. Choose whether to name the website and tap .



## ◆ Accessing your favorites

1. Launch the browser and drag  up. On the displayed screen, tap **favorites**.
2. Tap the website you wish to visit.

## ◆ Deleting your favorites

1. Launch the browser and drag  up. On the displayed screen, tap **favorites**.
2. Tap and hold the website you wish to delete from your favorites. Then tap **delete** on the displayed option menu.

## ◆ Editing your favorites

1. Launch the browser and drag  up. On the displayed screen, tap **favorites**.
2. Tap and hold the website you wish to edit. Then tap **edit** on the displayed option menu.
3. When done, tap .

## ◆ Clearing your browser history

To better protect your privacy, clear your browsing history from time to time.



1. Launch the browser and drag  up. On the displayed screen, tap **settings**.
2. Tap **delete history**.

# Sharing

You can share the latest news, hottest songs, stunning photos, and much more with your family and friends.

## Turning on Bluetooth

Your phone can use Bluetooth to connect to a device within 10 meters. Obstacles, such as walls and electrical appliances, may affect your Bluetooth connection.

1. In the application list, tap  > **Bluetooth**.
2. Switch Bluetooth to **On** .

## Sharing files using Bluetooth

You can use Bluetooth to share photos, videos, and songs with your family and friends.

 To share files using Bluetooth, enable Bluetooth on your phone and the receiving device.

1. Tap and hold the file you wish to send.
2. Tap **share...** > **Bluetooth** on the displayed option menu.
3. Tap the receiving device to start sending the file.

When another device is trying to send a file to your phone using **Bluetooth**, tap **accept** in the displayed dialog box to start receiving the file.

## Copying files to and from your computer

1. Connect your phone to your computer using a USB cable.
2. Open the new drive that appears on your computer to view files stored in your phone.
3. Copy the desired files to and from your computer.



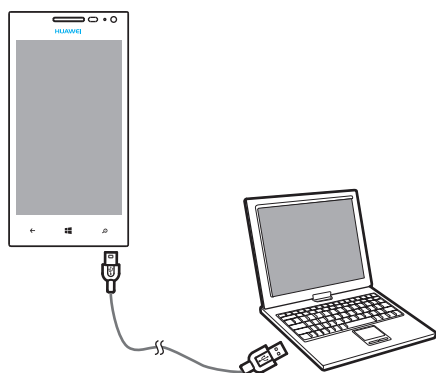





# Messaging

**Messaging** makes it easy to stay in contact with your friends using text messages or online chat.





## Sending a text message

1. In the application list, tap .
2. Flick left or right to go to **threads**.
3. Tap .
4. Enter the recipient's phone number, or tap  to select a recipient from your contact list.
5. Tap **type a message** and write your text message.
6. When done, tap  to send the message.

## Sending a multimedia message

Want to share your favorite photos and videos with friends and family? Attach them to your messages and spread the smiles all around.



 Sending multimedia messages may cost more than sending text messages. For details, contact your service provider.

1. In the application list, tap .
2. Flick left or right to go to **threads**.
3. Tap .
4. Enter the recipient's phone number, or tap  to select a recipient from your contact list.
5. Tap **type a message** and write your message.
6. Tap  to attach a photo or video.
7. When done, tap  to send the multimedia message.

## 💧 Chatting online

Chat with your friends online with Windows Live.

Before using Windows Live, make sure you've signed in to your Microsoft account.

1. In the application list, tap .
2. Flick left or right to go to **online**.
3. Tap  and set your status.
4. Start chatting away.

## 💧 Viewing a thread



1. In the application list, tap .
2. Flick left or right to go to **threads**.

Conversations with the same contact are displayed in a thread.

3. Tap the thread you wish to view.
  - Tap **type a message** to reply to the contact.
  - Tap and hold any message. To delete it, tap **delete**. To forward it, tap **forward**. To copy it, tap **copy**.





## 💧 Sending a text message to a contact group

Want to send a text message to several contacts? Why waste time sending it to them one at a time when you can create a group and send it to all of them at once!

1. In the application list, tap  to enter the People hub.
2. Flick left or right to go to **together**.
3. In the **Groups** list, tap the desired group.
4. Tap **text** and write your text message.
5. When done, tap .

## ◆ Deleting a message

You can delete a thread from the message list or open a thread to delete individual messages.



1. In the application list, tap .
  2. Flick left or right to go to **threads**.
  3. In the message list, find the thread or message you wish to delete.
  4. Tap and hold the thread or message. Then tap **delete** on the displayed option menu.
-  You can also tap  from the message list, select multiple threads, and tap  to delete them simultaneously.

# Email

Your phone lets you send and receive emails to keep you connected even when you are on the go.





## Adding an email account

To send and receive emails using multiple mailboxes, add multiple email accounts to your phone.



1. In the application list, tap  > **email + accounts**.
2. Tap  to select an email account type.
3. Follow the onscreen instructions to enter your email address, password, and required information.
4. Tap **sign in**.

 After you add an email account, it appears in your application list.

## Checking emails

1. In the application list, tap the mailbox you wish to check.
  2. In the inbox, flick left or right to find the email you wish to view.
    - To reply to the sender, tap  > **reply**.
    - To reply to the sender and all recipients, tap  > **reply all**.
    - To forward the email, tap  > **forward**.
-  Retrieving your emails may be slightly delayed, depending on the network condition. Tap  to refresh your mailbox.

## Sending an email

1. In the application list, tap the mailbox you wish to use.
2. Tap .
3. Enter the recipients and subject and compose your email.
4. When done, tap .

## ◆ Deleting an email

1. In the application list, tap the mailbox you wish to use.
2. In the email list, tap and hold the email you wish to delete.
3. Tap **delete** on the displayed option menu.



You can also select several emails and tap  to delete them simultaneously.

## ◆ Modifying email account settings

You can name mailboxes, set how often they refresh, and more.

1. In the application list, tap  > **email + accounts**.
2. In the mailbox list, tap the email account you wish to configure.
3. Follow the onscreen instructions to modify the email account settings.



Do not change the default email account server address; otherwise you may not be able to send or receive emails.

## ◆ Linking mailboxes into one

Busy switching between multiple email accounts and worried about missing emails? You can link your mailboxes into one unified inbox to see all your emails at a glance.





Add all necessary email accounts to your phone.

1. In the application list, tap any of the mailboxes you need.
2. Drag  up. On the displayed screen, tap **link inboxes**.
3. In the **other inboxes** list, tap the mailboxes you wish to link to the mailbox you tapped in step 1.
4. Tap **rename linked inbox** and enter a new name.

The new unified mailbox then appears in the application list.

## ◆ Unlinking mailboxes

1. In the application list, tap .
2. Drag  up. On the displayed screen, tap **linked inboxes**.
3. In the **this inbox** list, tap the mailbox you wish to unlink.
4. Tap **unlink**.

# Camera

Your phone helps you capture the memories you want to keep forever.

Press the camera button to turn on the camera.



---

Select a lens.

- 1 Before using this function, download the desired lenses from Store.

- 
- 2 Turn the flash on or off.

- 
- 3 Toggle between the front and rear cameras.

- 
- 4 Toggle between photo and video capture modes.

- 
- 5 Display more options.
-



## ◆ Taking a photo

1. Press the camera button to turn on the camera.
2. Frame the image you wish to capture. Press the camera button halfway to focus.
3. Press the camera button all the way to take a photo.

## ◆ Shooting a video

1. Open the camera and tap  to switch to video capture mode.
2. Tap the screen to start recording.
3. Tap the screen again to stop recording.

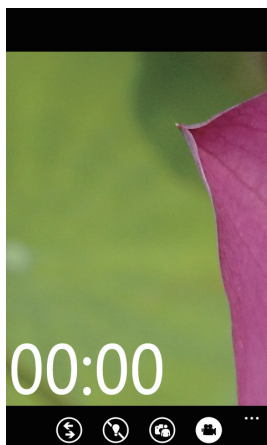

# Photos hub

The Photos hub lets you view all images saved in your phone's memory, microSD card, and SNS accounts.

In the application list, tap  to enter the Photos hub.

## Viewing photos

Your phone automatically categorizes your photos to let you find them quickly.

-  Viewing photos from the web will generate data traffic. If you are going to use a mobile network, contact your service provider to choose an appropriate data plan.

In the Photos hub, tap the desired photos to view them.

Pinch two fingers together to zoom out or stretch them apart to zoom in.

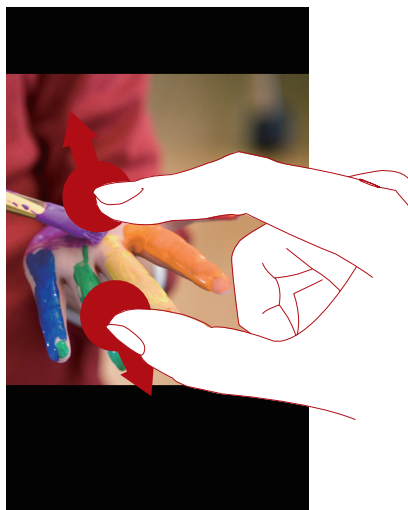

## ◆ Marking a photo as your favorite

Would you like to quickly and easily find photos of your family and friends? Mark them as your favorites.

1. In the Photos hub, select the desired photo.
2. Drag **⋮** up. On the displayed screen, tap **add to favorites**.

To view your favorite photos, open the Photos hub and flick left or right to go to **favorites**.

## ◆ Sharing photos and videos

Some photos and videos are so exciting that you just can't wait to share them! Use your phone to send them to your friends and family via MMS or email, or even post them to SNSs.

1. Open the Photos hub and tap the photo you wish to share.
2. Drag **⋮** up. On the displayed screen, tap **share...**
3. Select a sharing method.
4. Follow the onscreen instructions to share the photo.

The onscreen instructions vary depending on the sharing method you select.

## ◆ Changing the Photos hub background

You can set any photo as the Photos hub background or let your phone shuffle through photos.



Open the Photos hub and drag **⋮** up. On the displayed screen, you can:

- Tap **choose background**, select the desired photo, and tap .
- Tap **shuffle background** to have your phone shuffle through photos in your albums.





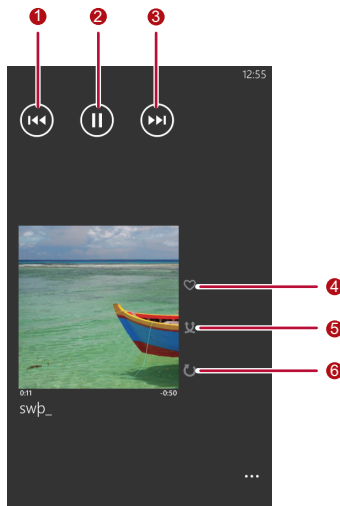

# 📍 Entertainment

## 📍 Listening to music

In the mood for music? Your phone makes listening to music a walk in the park.

1. In the application list, tap .
2. Tap **music**.
3. Find the song you wish to listen to and tap .



- 
- |   |   |
|---|---|
| 1 | Tap  to replay or switch to the previous song. Tap and hold  to rewind. |
|---|---|
- 
- |   |  |
|---|--|
| 2 | Tap  to pause the playback. |
|---|--|
- 
- |   |   |
|---|---|
| 3 | Tap  to switch to the next song. Tap and hold  to fast-forward. |
|---|---|
- 
- |   |   |
|---|---|
| 4 | Tap  to rate a song. |
|---|---|
- 
- |   |   |
|---|---|
| 5 | Tap  to shuffle. |
|---|---|
-

---



6 Tap ↺ to replay the current song.

---

 On the playback screen, you can simply flick left to switch to the previous song or flick right to switch to the next song.

## Watching videos

Your phone can work as a portable video player so you can watch downloaded or streaming videos wherever you want.

1. In the application list, tap .
2. Tap **videos**.
3. Find the video you want and tap .

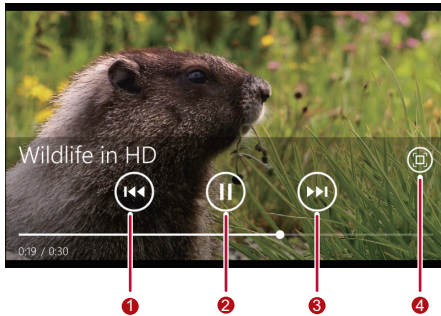

---

1 Tap  to rewind.

---

2 Tap  to pause the playback.

---

3 Tap  to fast-forward.

---

4 Tap  to play the video in full-screen mode.

---

# Navigation

Who needs a guide when your phone can navigate for you?

## Turning on GPS

When GPS is turned on, your current location is available on other applications, such as Maps.

The accuracy of your position is influenced by factors such as the weather and environment.

1. In the application list, tap  > **location**.
2. Switch GPS to **On** .

## Browsing the map

Maps help you find the address you are looking for, show you how to get to a destination, and display real-time traffic. You can also switch to an aerial view.

In the application list, tap  to open Maps. You can:

- Pinch two fingers together to zoom out or stretch them apart to zoom in.
- Drag  up. On the displayed screen, tap **search**, **aerial view off**, or **favorite places**. Then follow the onscreen instructions to complete the operation.

# Calendar

Always forgetting birthdays and other important events? Problem solved! Your phone's calendar is a personal assistant that helps you keep track of all your important dates. You will never miss another anniversary, meeting, or appointment again.

## Viewing the calendar

In the application list, tap . Flick left or right to go to **day** to view your appointments for the day.

Flick up and down to view more.

Tap  to view your appointments for the entire month. Flick up to view your appointments in the previous month and flick down to view the appointments for the next month.



## Viewing your agenda

In the application list, tap . Flick left or right to go to **agenda**.

Flick up and down to browse your appointments.





## Adding an appointment

Add appointments to your phone and set reminders for them. You don't need to worry about forgetting important appointments any more.

1. In the application list, tap  > .
2. Configure the required settings.
3. If you have signed in to multiple accounts, select the account to which you wish to save this appointment.
4. Tap **more details** to set a reminder and add attendees.
5. When done, tap .

## ◆ Adding a to-do task

Adding to-do tasks to your phone and setting their priorities help you better manage your day.



1. In the application list, tap . Then flick left or right to go to **to-do**.
2. Configure the required settings.
3. If you have signed in to multiple accounts, select the account to which you wish to save this to-do task.
4. When done, tap .
  - To sort the to-do tasks by priority, drag  up. Then tap **sort by priority** on the displayed screen.
  - To mark a task as completed, tap the task and . The task then disappears from the to-do list.



# Alarms

## Adding an alarm

Set alarms on your phone, and you'll never have to worry about being late again.

1. In the application list, tap .
2. Tap .
3. Follow the onscreen instructions to set the alarm time, sound, how often it repeats, and more.
4. When done, tap .

## Turning on and off an alarm

On the alarm screen, flick the switch next to an alarm left to turn it on or right to turn it off.







## Deleting an alarm

Tap the alarm and then .







# Office

Your phone is equipped with Microsoft Office, which lets you work even when you are away from the office. Create and edit Excel workbooks, Word documents, PowerPoint presentations, OneNote notes, and more.

## Creating and editing a Word document



1. In the application list, tap .
2. Flick left or right to go to **recent**.
3. Tap  > **Word** to create a blank Word document.
4. Write your text.
  - Tap  to view the document outline.
  - Tap  to add a comment.
  - Tap  to search the document.
  - Tap  to change the text format and color.
5. When done, drag  up. On the displayed screen, tap **save**.
6. Follow the onscreen instructions to enter the name and save path of the document. Then tap **save**.

## Creating and editing an Excel workbook

1. In the application list, tap .
2. Flick left or right to go to **recent**.
3. Tap  > **Excel** to create a blank Excel workbook.
4. Edit the file.
  - Tap  to move on to another worksheet.
  - Tap  to use a function.
  - Tap  to search the workbook.
  - Tap  to sort the cells.

5. When done, drag  up. On the displayed screen, tap **save**.
6. Follow the onscreen instructions to enter the name and save path of the workbook. Then tap **save**.

## 🔹 Viewing and editing a PowerPoint presentation

1. In the application list, tap .
2. Flick left or right to go to **recent** and tap the desired PowerPoint file.
3. Rotate your phone to view the PowerPoint file in landscape view. Flick left and right to switch between slides.
4. Tap  to edit the file.
5. When done, drag  up. On the displayed screen, tap **save**.

## 🔹 Saving a file to Windows Live SkyDrive

You can save files on your phone to Windows Live SkyDrive and then share them. You can also access files on Windows Live SkyDrive from your computer.

 To use Windows Live SkyDrive, sign in to your Microsoft account on your phone.

1. In the application list, tap .
2. Flick left or right to go to **places**.
3. Tap **phone**.
4. Tap and hold a file and tap **save to... > SkyDrive**.

# Applications

Want to discover a rich collection of applications and try out the hottest games? Well then go ahead to see how to enrich your phone!

## Downloading applications

You can download applications to your phone in either of the following ways:

- Download applications from the Store.
- Connect your phone to a computer and copy downloaded applications from the computer.

## Installing applications from the Store

Your phone is preinstalled with the Store, which offers a wide variety of applications for you to download and install. Some applications are free of charge while others are not.



Using your phone to download applications over your mobile data connection may result in high data traffic. We suggest you use a WLAN instead.

1. In the application list, tap .
2. Flick left and right to switch between application categories.
3. Tap the desired application to view its details. Flick left and right to view user comments and other information.
4. Tap **install** to install the application.

## Uninstalling applications





You can only uninstall third-party applications.

1. In the application list, tap and hold the application you wish to uninstall.
2. From the displayed option menu, tap **uninstall**.
3. Follow the onscreen instructions to complete the operation.

# Phone settings

## Traffic manager

Set a limit for your phone's data traffic to keep your data fees under control.

1. In the application list, tap .
2. Tap  > **set limit**.
3. Set a data limit and other details and tap .

Flick left or right to go to **usage** to view the data traffic of each application.

## Setting the time zone and language

Are you on an international business trip? Adjust your phone's time zone settings to keep track of time. You can also change your phone's language.

1. In the application list, tap  > **language + region**.
2. Follow the onscreen instructions to set the time zone, language, region, and more.
3. When done, tap **restart phone**.

The language and time zone changes take effect when your phone restarts.

## Checking your phone storage

In the application list, tap  > **phone storage** to view details about your phone memory and microSD card storage.

If your phone is configured with a microSD card, you can change the save location of photos, music, and videos.

## Backup



Back up your applications, messages, photos, and videos in your phone to a cloud server so they'll always be handy.

Your data will be backed up to the Microsoft cloud server. To use this function, sign in to your Microsoft account on your phone.

1. In the application list, tap  > **backup**.
2. Select the data you wish to back up, for example, **text messages**, **app list + settings**, and **photos**.
3. Follow the onscreen instructions to back up the selected data.

## Phone finder

If your phone gets lost or stolen, you can use the phone finder function to find the phone, lock it, or erase data from it.

 To use this function, you must sign in to your Microsoft account on your phone before your phone is lost. Then, follow these steps: In the application list, tap  > **find my phone**. Read the onscreen instructions and perform the required settings.

1. From a computer or other Internet-capable devices, log in to <http://www.windowsphone.com> with your Microsoft account.
2. On the displayed web page, send a message to your phone, lock it, or erase your data from it.

## FAQs

### How can I forward a text message?

1. In the application list, tap .
2. Flick left or right to go to **threads**.
3. Tap the thread that contains the text message you wish to forward.
4. Tap and hold the text message you wish to forward.
5. Tap **forward** on the displayed option menu.

### Can I disable the auto-rotate screen function?

Unfortunately, no.



### Will my alarms still sound if I power off my phone?

No.

### How can I hide the onscreen keyboard?

Tap .



### How can I reduce my mobile data traffic?

- When you are not accessing the Internet, turn off your mobile data connection as follows:  
Tap  > **cellular**. Then set data connection to **off**.
- When a WLAN is available, connect to the WLAN to access the Internet.
- Set your email accounts to refresh less often.  
On the mailbox screen, drag  up. On the displayed screen, tap **settings** > **sync settings** and set the refresh frequency to a smaller value.

### How can I format a microSD card?

1. In the application list, tap  > **phone storage**.
2. Tap **SD card** > **format SD card**.

### How can I adjust the date and time?

1. In the application list, tap  > **date + time**.
2. Switch automatic adjustment to **off** .
3. Tap the **Date** box to set the date and the **Time** box to set the time.

How can I save my photos and videos to a different location?

1. In the application list, tap  > **phone storage**.
2. Follow the onscreen instructions to specify whether your photos, videos, and songs are saved to your phone memory or microSD card.

What can I do if I forget the screen unlock pattern or password?

Please contact Huawei customer service personnel for help.



## For more help

Please visit [www.huaweidevice.com/worldwide/support/hotline](http://www.huaweidevice.com/worldwide/support/hotline) for recently updated hotlines and email address for your country or region.

# Personal information and data security

The use of some functions or third-party applications on your device could result in your personal information and data being lost or becoming accessible to others. Several measures are recommended to help you protect personal and confidential information.

- Place your device in a safe area to prevent it from unauthorized use.
- Set your device screen to lock and create a password or unlock pattern to open it.
- Periodically back up personal information kept on your SIM/UIM card, memory card, or stored in your device memory. If you change to a different device, be sure to move or delete any personal information on your old device.
- If you are worried about viruses when you receive messages or emails from a stranger, you can delete them without opening them.
- If you use your device to browse the Internet, avoid websites that might pose a security risk to avoid theft of your personal information.
- Install or upgrade device security software and regularly scan for viruses.
- Be sure to obtain third-party applications from a legitimate source. Downloaded third-party applications should be scanned for viruses.
- Install security software or patches released by Huawei or third-party application providers.
- Some applications require and transmit location information. As a result, a third-party may be able to share your location information.
- Your device may provide detection and diagnostic information to third-party application providers. Third party vendors use this information to improve their products and services.
- If you have concerns about the security of your personal information and data, please contact [mobile@huawei.com](mailto:mobile@huawei.com).

# Legal Notice

Copyright © Huawei Technologies Co., Ltd. 2013. All rights reserved.

No part of this manual may be reproduced or transmitted in any form or by any means without prior written consent of Huawei Technologies Co., Ltd. and its affiliates ("Huawei").

The product described in this manual may include copyrighted software of Huawei and possible licensors. Customers shall not in any manner reproduce, distribute, modify, decompile, disassemble, decrypt, extract, reverse engineer, lease, assign, or sublicense the said software, unless such restrictions are prohibited by applicable laws or such actions are approved by respective copyright holders.

## Trademarks and Permissions



 and **HUAWEI** are trademarks or registered trademarks of Huawei Technologies Co., Ltd.

The *Bluetooth*<sup>®</sup> word mark and logos are registered trademarks owned by *Bluetooth SIG, Inc.* and any use of such marks by Huawei Technologies Co., Ltd. is under license.

Microsoft, Windows, and  Windows Phone are trademarks of the Microsoft group of companies.

Other trademarks, product, service and company names mentioned may be the property of their respective owners.

## Notice

Some features of the product and its accessories described herein rely on the software installed, capacities and settings of local network, and therefore may not be activated or may be limited by local network operators or network service providers.

Thus, the descriptions herein may not exactly match the product or its accessories which you purchase.

Huawei reserves the right to change or modify any information or specifications contained in this manual without prior notice and without any liability.

### Third-Party Software Statement

Huawei does not own the intellectual property of the third-party software and applications that are delivered with this product. Therefore, Huawei will not provide any warranty of any kind for third party software and applications. Neither will Huawei provide support to customers who use third-party software and applications, nor be responsible or liable for the functions or performance of third-party software and applications.

Third-party software and applications services may be interrupted or terminated at any time, and Huawei does not guarantee the availability of any content or service. Third-party service providers provide content and services through network or transmission tools outside of the control of Huawei. To the greatest extent permitted by applicable law, it is explicitly stated that Huawei shall not compensate or be liable for services provided by third-party service providers, or the interruption or termination of third-party contents or services.

Huawei shall not be responsible for the legality, quality, or any other aspects of any software installed on this product, or for any uploaded or downloaded third-party works in any form, including but not limited to texts, images, videos, or software etc. Customers shall bear the risk for any and all effects, including incompatibility between the software and this product, which result from installing software or uploading or downloading the third-party works.

### DISCLAIMER

ALL CONTENTS OF THIS MANUAL ARE PROVIDED "AS IS". EXCEPT AS REQUIRED BY APPLICABLE LAWS, NO WARRANTIES OF ANY KIND, EITHER EXPRESS OR IMPLIED, INCLUDING BUT NOT LIMITED TO, THE IMPLIED WARRANTIES OF MERCHANTABILITY AND FITNESS FOR A PARTICULAR PURPOSE, ARE MADE IN RELATION TO THE ACCURACY, RELIABILITY OR CONTENTS OF THIS MANUAL.

TO THE MAXIMUM EXTENT PERMITTED BY APPLICABLE LAW, IN NO EVENT SHALL HUAWEI BE LIABLE FOR ANY SPECIAL, INCIDENTAL, INDIRECT, OR CONSEQUENTIAL DAMAGES, OR LOSS OF PROFITS, BUSINESS, REVENUE, DATA, GOODWILL SAVINGS OR ANTICIPATED SAVINGS REGARDLESS OF WHETHER SUCH LOSSES ARE FORSEEABLE OR NOT.

THE MAXIMUM LIABILITY (THIS LIMITATION SHALL NOT APPLY TO LIABILITY FOR PERSONAL INJURY TO THE EXTENT APPLICABLE LAW PROHIBITS SUCH A LIMITATION) OF HUAWEI ARISING FROM THE USE

OF THE PRODUCT DESCRIBED IN THIS MANUAL SHALL BE LIMITED TO THE AMOUNT PAID BY CUSTOMERS FOR THE PURCHASE OF THIS PRODUCT.

### [Import and Export Regulations](#)

Customers shall comply with all applicable export or import laws and regulations and be responsible to obtain all necessary governmental permits and licenses in order to export, re-export or import the product mentioned in this manual including the software and technical data therein.

### [Privacy Policy](#)

Please refer to our privacy policy on our websites for the information about how we protect your personal information.

