

SONY[®]

XPERIA

P

User guide

Contents

Important information.....	7
Android™ – what and why?.....	8
Applications.....	8
Getting started.....	9
Assembly.....	9
Turning the phone on and off	9
Setup guide.....	10
Screen lock.....	10
Accounts and services.....	11
Getting to know your phone.....	13
Phone overview.....	13
Battery.....	13
Using the keys.....	16
Using the touchscreen.....	16
Home screen.....	18
Accessing and using applications.....	20
Status and notifications.....	22
Phone settings menu.....	23
Typing text.....	24
Customising your phone.....	28
Memory.....	31
Using a headset with your phone.....	31
Internet and messaging settings.....	32
Using Data monitor.....	33
Turning off data traffic.....	33
Data roaming.....	34
Network settings.....	34
Calling.....	35
Emergency calls.....	35
Call handling.....	35
Voicemail.....	36
Multiple calls.....	37
Conference calls.....	37
Call settings.....	38
Contacts	39
Transferring contacts to your new phone.....	39
Contacts screen overview.....	40
Managing your contacts.....	41
Communicating with your contacts.....	42

Sharing your contacts.....	43
Backing up contacts.....	43
Messaging.....	44
Using text and multimedia messaging.....	44
Text and multimedia message options.....	45
Email.....	47
Using email.....	47
Using email accounts.....	50
Gmail™ and other Google™ services	50
Google Talk™	52
Timescape™.....	53
Timescape™ main view.....	53
Using Timescape™	53
Timescape™ settings.....	55
Timescape™ Feed widget.....	55
Timescape™ Friends widget.....	56
Timescape™ Share widget.....	57
Getting started with Android Market™.....	58
Downloading from Android Market™.....	58
Clearing your application data.....	58
Permissions.....	59
Installing applications not from Android Market™	59
PlayNow™ service.....	60
Before you download content.....	60
Downloading from the PlayNow™ service.....	60
Video Unlimited™.....	61
Video Unlimited™ menu overview.....	61
Creating a Video Unlimited™ account.....	61
Exploring the Video Unlimited™ selection.....	61
Renting or buying a video.....	61
Watching a video from Video Unlimited™	62
Music Unlimited™.....	63
Getting organised.....	64
Calendar.....	64
Alarm clock.....	64
Scanning with the NeoReader™ application.....	67
NeoReader™ application menu overview.....	67
Synchronising data on your phone.....	68
Synchronising with Google™.....	68
Synchronising your corporate email, calendar and contacts.....	68
Synchronising with Facebook™	69

Synchronising using SyncML™	70
NFC.....	72
NFC detection area.....	72
Connecting to wireless networks.....	75
Wi-Fi®	75
Virtual private networks (VPNs).....	80
Web browser.....	81
Toolbar.....	81
Browsing the web.....	81
Navigating web pages.....	82
Managing bookmarks.....	82
Managing text and images.....	83
Multiple windows.....	83
Downloading from the web.....	84
Browser settings.....	84
Music.....	86
Protecting your hearing.....	86
Copying media files to your phone's internal storage	86
Using the music player	86
Identifying music using TrackID technology.....	91
Using TrackID™ technology results.....	91
Using TrackID™ to identify tracks on the FM Radio.....	92
Using the FM radio.....	93
FM radio overview.....	93
Using your favourite radio channels.....	93
Making a new search for radio channels.....	94
Switching the radio sound between devices.....	94
Switching between mono and stereo sound mode.....	94
Identifying radio tracks using TrackID™	94
Sharing the details of music you like on Facebook™	95
Taking photos and recording videos.....	96
Camera controls overview.....	96
Using the still camera.....	96
Using the video camera.....	103
3D camera	108
3D Camera overview.....	108
Viewing photos and videos in Gallery.....	110
Mobile BRAVIA® Engine.....	110
Working with albums.....	111
Working with photos in Gallery.....	112

Viewing photos in 3D Album.....	115
Managing your photos in 3D Album.....	115
Bluetooth™ wireless technology.....	116
Naming your phone.....	116
Pairing with another Bluetooth™ device.....	116
Sending and receiving items using Bluetooth™ technology.....	117
Connecting your phone to a computer.....	119
Transferring and handling content using a USB cable.....	119
Transferring files using Media transfer mode via Wi-Fi®.....	119
PC Companion.....	120
Media Go™	120
Connecting your phone to a TV set.....	122
Using location services to find your position.....	123
Using GPS.....	123
Google Maps™.....	124
Using Google Maps™ to get directions.....	124
Backing up and restoring phone content.....	125
Types of content you can back up.....	125
Locking and protecting your phone.....	126
IMEI number.....	126
SIM card protection.....	126
Setting a screen lock.....	127
Updating your phone.....	129
Updating your phone wirelessly.....	129
Updating your phone using a USB cable connection.....	129
Phone settings overview.....	131
Status and notification icons overview.....	132
Status icons.....	132
Notification icons.....	132
Application overview.....	134
User support.....	136
Troubleshooting.....	137
My phone is not working as expected.....	137
Resetting the phone.....	137
No battery charging icon appears when phone starts charging.....	138
The battery performance is low.....	138
I cannot transfer content between my phone and the computer, when using a USB cable.....	138
I cannot use Internet-based services.....	138
Error messages.....	138

Recycling your phone.....	139
Legal information.....	140
Index.....	141

Important information

Please read the *Important information* leaflet before you use your mobile phone.

- ! Some of the services and features described in this User guide are not supported in all countries/regions or by all networks and/or service providers in all areas. Without limitation, this applies to the GSM International Emergency Number 112. Please contact your network operator or service provider to determine availability of any specific service or feature and whether additional access or usage fees apply.

Android™ – what and why?

Your Xperia smartphone from Sony runs on the Android platform. Android phones can perform many of the same functions as a computer and you can customise them to your own needs. For example, you can add and delete applications, or enhance existing applications to improve functionality. At Android Market™ you can download a range of applications and games from a constantly growing collection. You can also integrate applications on your Android™ phone with other applications and with online services that you use. For example, you can back up your phone contacts, access your different email accounts and calendars from one place, keep track of your appointments, and engage in social networking.

Android™ phones are constantly evolving. When a new software version is available and your phone supports this new software, you can update your phone to get new features and the latest improvements.

 Your Android™ phone is pre-loaded with Google™ services. To get the most out of the provided Google™ services, you should have a Google™ account and sign in to it when you first start your phone. You also need to have Internet access to use many of the features in Android™.

 New software releases may not be compatible with all phones.

Applications

An application is a phone program that helps you perform a task. For example, there are applications to make calls, take photos and download more applications.

Getting started

Assembly

To insert the micro SIM card

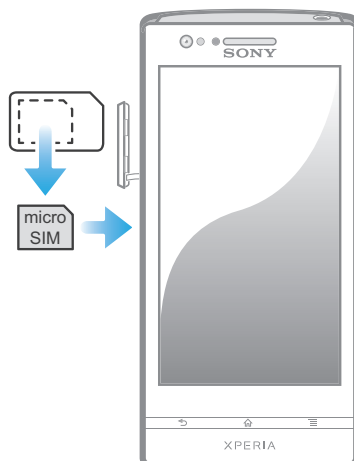

- 1 Insert a fingernail into the gap alongside the cover of the micro SIM card slot, then detach the cover from the slot.
- 2 Insert the micro SIM card into its slot with the gold-coloured contacts facing outwards.
- 3 Re-attach the cover of the micro SIM card slot.

To remove the SIM card

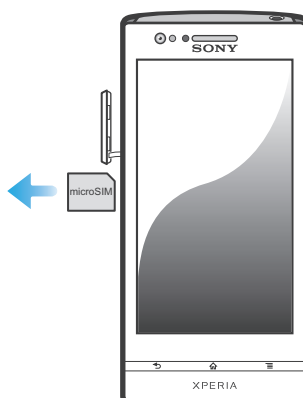





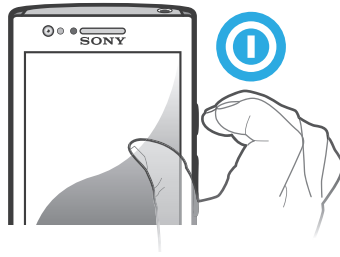

- 1 Remove the cover of the SIM card slot.
- 2 Press against the edge of the SIM card and release it, then draw the SIM card outwards to remove it.

Turning the phone on and off



To turn on the phone

- ! Make sure that the battery is charged for at least 30 minutes before you turn on the phone for the first time.



- 1 Press and hold down the power key  on the right side of the phone until the phone vibrates.
 - 2 If your screen goes dark, briefly press the power key  to activate the screen.
 - 3 To unlock the screen, drag  to the right across the screen.
 - 4 Enter your SIM card PIN when requested, and select **OK**.
 - 5 Wait a while for the phone to start.
-  Your SIM card PIN is initially supplied by your network operator, but you can change it later from the **Settings** menu. To correct a mistake made while entering your SIM card PIN, tap .

To turn off the phone

- 1 Press and hold down the power  key until the options menu opens.
 - 2 In the options menu, tap **Power off**.
 - 3 Tap **OK**.
-  It may take a while for the phone to shut down.

Setup guide

The first time you start your phone, a setup guide opens to explain basic phone functions and help you enter essential settings. This is a good time to configure the phone to your specific needs. You can also skip some steps and access the setup guide manually at a later stage.

To access the setup guide manually

- 1 From the Home screen, tap .
- 2 Find and tap **Setup guide**.



Screen lock

When your phone is on and left idle for a set period of time, the screen darkens to save battery power, and locks automatically. This lock prevents unwanted actions on the touchscreen when you are not using it. On the lockscreen, you can still view notifications, for example, notifications of missed calls and messages that arrived since the phone was last locked. You can also control the playback of audio tracks without unlocking the screen.

To activate the screen



- Briefly press the power key .

To view missed calls from the lockscreen

- 1 To activate the screen, briefly press the power key .
- 2 Drag  to the right across the screen.





To view new text messages from the lockscreen



- 1 To activate the screen, briefly press the power key .
- 2 Drag  to the right across the screen.





To play an audio track from the lockscreen

- 1 To activate the screen, briefly press the power key .
- 2 To display music player controls, place a finger on the time and date area and flick to the left.
- 3 Tap .

To pause an audio track from the lockscreen

- 1 To activate the screen, briefly press the power key .
- 2 When the music player controls appear, tap .

To change the currently playing audio track from the lockscreen

- 1 To activate the screen, briefly press the power key .
- 2 When the music player controls appear, tap  or .

To unlock the screen



- Drag  to the right across the screen.

To lock the screen manually

- When the screen is active, briefly press the power key .

Accounts and services

Sign in to your online service accounts from your phone and benefit from a range of services. Combine services and get even more out of them. For example, collect contacts from your Google™ and Facebook™ accounts and integrate them into your phonebook, so you have everything in one place.

You can sign up to online services from your phone as well as from a computer. When you sign up for the first time, an account is created with your user name, password, settings and personal information. The next time you sign in, you get a personalised view.

Google™ account

Having a Google account is key to using a range of applications and services with your Android phone. You need a Google™ account, for example, to use the Gmail™ application in your phone, to chat to friends using Google Talk™, to synchronise your phone calendar with your Google Calendar™, and to download applications and games from Android Market™.

Microsoft® Exchange ActiveSync® account

Synchronise your phone with your corporate Microsoft® Exchange ActiveSync® account. This way, you keep your work email, contacts and calendar events with you at all times.

Facebook™ account

Facebook™ connects you with friends, family and colleagues all over the world. Log in now to share your world with others.

SyncML™ account

Synchronise your phone with an Internet server using SyncML™. View and manage contacts, calendar events and bookmarks from your phone just as easily as you would from a computer.

Getting to know your phone

Phone overview

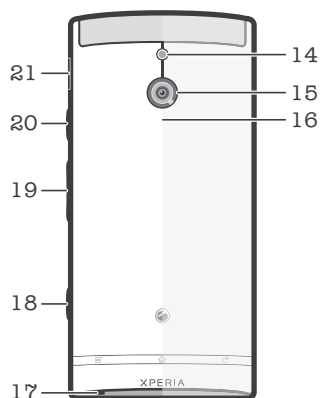
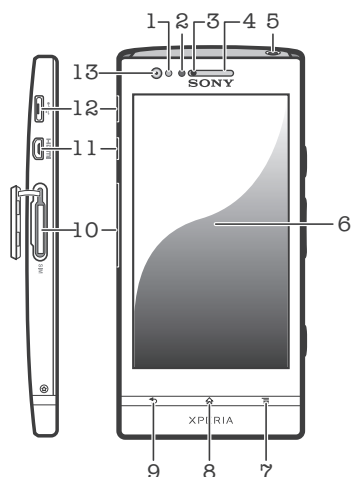

- | | |
|----------------------------------|-------------------------------------|
| 1. Light sensor/Proximity sensor | 12. Connector for charger/USB cable |
| 2. Proximity LED | 13. Front camera lens |
| 3. Notification LED | 14. Camera LED light |
| 4. Ear speaker | 15. Camera lens |
| 5. Headset connector | 16. NFC detection area |
| 6. Touchscreen | 17. Main microphone |
| 7. Menu key | 18. Camera key |
| 8. Home key | 19. Volume/Zoom key |
| 9. Back key | 20. Power key |
| 10. SIM card slot | 21. Speaker |
| 11. HDMI™ connector | |

Battery

Your phone has an embedded battery.

Charging the battery

Charge your phone for at least 30 minutes before you turn on the phone for the first time. When you connect the phone charger cable to a power source, such as a USB port or a phone charger, it may take a few minutes before the battery icon  appears on the screen. You can still use your phone while it is charging. Charging the phone over a long period of time, for example, overnight, does not damage the battery or the phone.

- ! The battery will start to discharge a little after it is fully charged and then charges again after a certain time when the phone charger is connected. This is to extend battery life and may result in the charge status showing a level below 100 percent.

To charge the phone

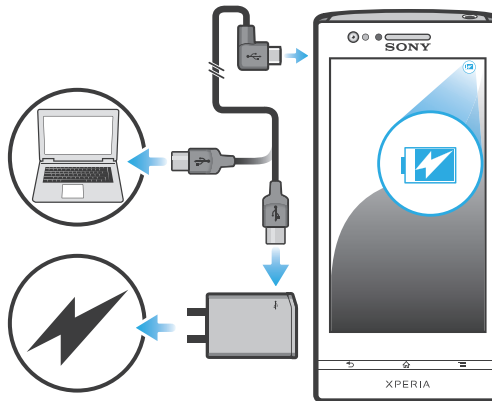

- 1 Plug the phone charger into a power outlet.
- 2 Plug one end of the USB cable into the charger (or into the USB port of a computer).
- 3 Plug the other end of the cable into the micro USB port on your phone, with the USB symbol facing up. The battery status LED lights up when charging starts. If the battery is completely discharged, it may take a few minutes before the LED lights up after you connect the phone charger cable to a power source.

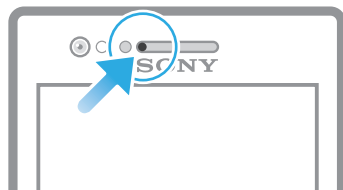

- 4 When the battery status LED is green, the phone is fully charged. Disconnect the USB cable from your phone by pulling it straight outwards. Make sure not to bend the connector when removing the cable from the phone.

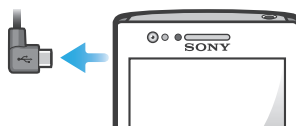

- ! Use the charger and USB cable provided with the phone to ensure faster charging.

Battery LED status

Green	The battery is fully charged
Flashing red	The battery level is low
Orange	The battery is charging. The battery level is between low and full

To check the battery level

- 1 From the Home screen, tap .
- 2 Find and tap **Settings** > **About phone** > **Status**.

Improving battery performance

The following tips can help you improve battery performance:

- Charge your phone often. This will not affect the lifetime of the battery.
- Downloading data from the Internet is power consuming. When you're not using the Internet, you can save power by disabling all data connections over mobile networks. This setting does not prevent your phone from transmitting data over other wireless networks.
- Turn off GPS, Bluetooth™ and Wi-Fi® when you don't need these features. You can turn them on and off more easily by adding the Quick settings widget to your Home screen. You do not need to turn off 3G.
- Use the **Power Saver** feature to reduce battery consumption. You can select the power saving mode that best suits the way you use your phone. You can also customise the settings of each power saving mode.
- Set your synchronisation applications (used to synchronise your email, calendar and contacts) to synchronise manually. You can also synchronise automatically, but increase the synchronisation intervals.
- Check the battery usage menu in the phone to see which applications use the most power. Your battery consumes more power when you use video and music streaming applications, such as YouTube™. Some Android Market™ applications also consume more power.
- Close and exit applications that you are not using.
- Lower the screen display brightness level.
- Turn off your phone or activate the **Airplane mode** setting if you are in an area with no network coverage. Otherwise, your phone repeatedly scans for available networks, and this consumes power.
- Use a Sony original handsfree device to listen to music. Handsfree devices demand less battery power than the phone's loudspeakers.
- Keep your phone in standby whenever possible. Standby time refers to the time during which the phone is connected to the network and is not being used.
- Go to www.sonymobile.com to get the latest battery performance tips for your phone model.

To access the battery usage menu

- 1 From the Home screen, tap .
- 2 Find and tap **Settings** > **About phone** > **Battery use** to see which installed applications consume the most battery power.

To add the Data traffic widget to your Home screen

- 1 From your Home screen, press .
- 2 Tap **Add** > **Widgets** > **Tools**.
- 3 Flick left to find and select the **Data traffic** widget. You can now turn on and off your data connection more easily.

To add the Quick settings widget to your Home screen

- 1 From your Home screen, press .
- 2 Tap **Add** > **Widgets** > **Tools**.
- 3 Select the **Quick settings** widget.

Reducing battery consumption with Power Saver

Use pre-set power saving modes to manage power consuming applications and reduce battery consumption. With Power Saver, you can also customise the settings within each power saving mode to the way you use your phone.

To activate a power saving mode

- 1 From your Home screen, tap .
- 2 Find and tap **Power Saver**.
- 3 Tap the icon next to the power saving mode that you want to activate.



To deactivate a power saving mode

- 1 From your Home screen, tap .
- 2 Find and tap **Power Saver**.
- 3 Tap the illuminated icon next to the active power saving mode to turn it off.

To change the settings for a power saving mode

- 1 From your Home screen, tap .
- 2 Find and tap **Power Saver**.
- 3 To open the settings menu, tap the name of a power saving mode.
- 4 Mark the features that you want to turn off to save power.
- 5 Tap **Done**.

To display power saver notifications

- 1 From your Home screen, tap .
- 2 Find and tap **Power Saver**.
- 3 Press , then select **Settings**.
- 4 Mark the **Notifications** checkbox.

Using the keys

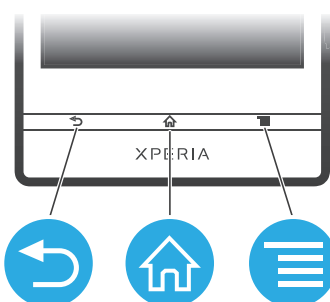

Back

- Go back to the previous screen
- Close the on-screen keypad, a dialog box, an options menu, or the Notification panel



Home

- Go to the Home screen
- Press and hold to open a window showing your most recently used applications



Menu

- Open a list of options available in the current screen or application

Using the touchscreen

A protective plastic sheet is attached to the screen of your phone when you buy it. You should peel off this sheet before using the touchscreen. Otherwise, the touchscreen might not function properly.

When your phone is on and left idle for a set period of time, the screen darkens to save battery power, and locks automatically. This lock prevents unwanted actions on the touchscreen when you are not using it. You can also set personal locks to protect your subscription and make sure only you can access your phone content.

- ! Your phone screen is made from glass. Do not touch the screen if the glass is cracked or shattered. Avoid trying to repair a damaged screen yourself. Glass screens are sensitive to drops and mechanical shocks. Cases of negligent care are not covered by the Sony warranty service.

To open or highlight an item

- Tap the item.

To mark or unmark options

- Tap the relevant checkbox or list option.

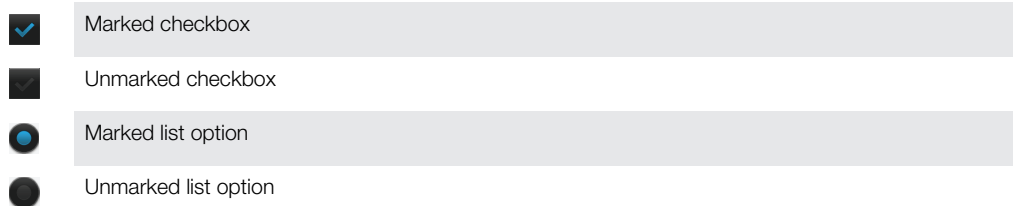

Zooming

The zoom options available depend on the application you are using.

To zoom

- When available, tap or to zoom in or out.
- ! You may have to drag the screen (in any direction) to make the zoom icons appear.

To zoom with two fingers

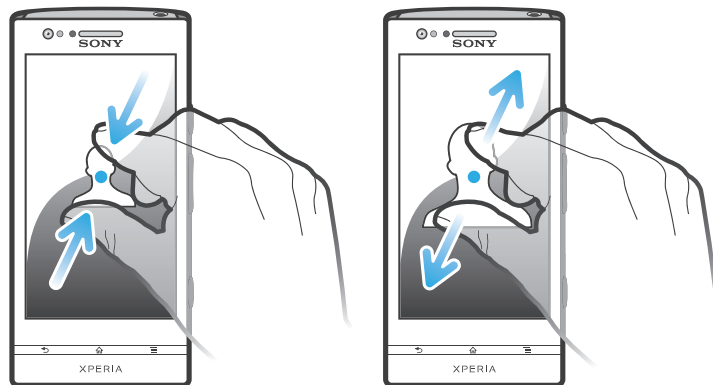

- Place two fingers on the screen at once and pinch them together (to zoom out) or spread them apart (to zoom in).
- 💡 Use the zoom function when viewing photos and maps, or when browsing the web.

Scrolling

Scroll by moving your finger up or down on the screen. On some web pages you can also scroll to the sides.

- ! Dragging or flicking will not activate anything on the screen.

To scroll

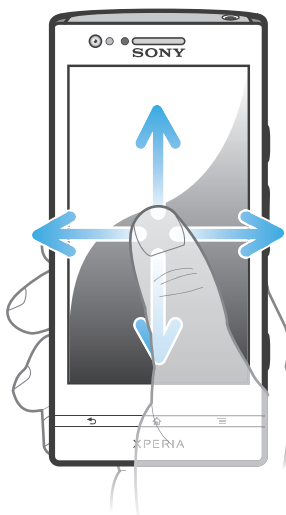

- Drag or flick your finger in the direction you want to scroll on the screen.
- 💡 To scroll more quickly, flick your finger in the direction you want to go on the screen.

To flick

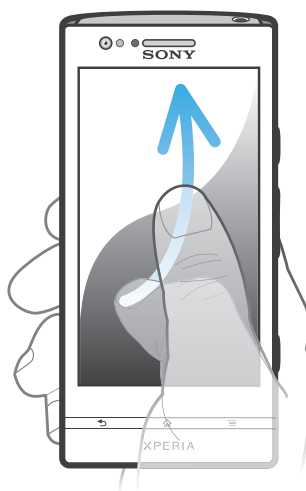

- To scroll more quickly, flick your finger in the direction you want to go on the screen. You can wait for the scrolling movement to stop by itself, or you can stop it immediately by tapping the screen.

Sensors

Your phone has sensors that detect both light and proximity. The light sensor detects the ambient light level and adjusts the brightness of the screen accordingly. The proximity sensor turns the touch screen off when your face touches the screen. This prevents you from unintentionally activating phone functions when you are engaged in a call.

Home screen

Your phone Home screen is the equivalent of the desktop on a computer. It's your gateway to the main features in your phone. You can customise your Home screen with widgets, shortcuts, folders, themes, wallpaper and other items.

The Home screen extends beyond the regular screen display width, so you need to flick left or right to view content in one of the screen's four extensions.  shows which part of the Home screen you are in.

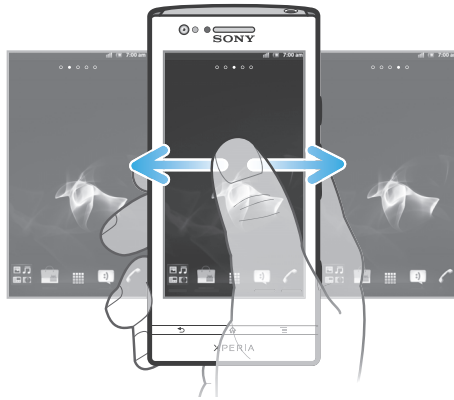

The items in the bar at the bottom of the screen are always available for quick access.



To go to the Home screen

- Press .

To browse the Home screen

- Flick right or left.

To share an item from your Home screen

- 1 Press  to open your Home screen.
- 2 Touch and hold an item until it magnifies and the phone vibrates, then drag the item to .
- 3 Select an option and confirm, if necessary. You can now share the applications and widgets you like with your friends so they can download and use them.

Widgets

Widgets are small applications that you can use directly on your Home screen. For example, the Music player widget allows you to start playing music directly.

To add a widget to the Home screen

- 1 From your Home screen, press .
- 2 Tap **Add > Widgets**.
- 3 Tap a widget.

To get an overview of all widgets on your Home screen

- Pinch on any area of your Home screen. All widgets from different parts of your Home screen are now displayed in one view.
-  When all Home screen widgets are combined in one view, tap on any widget to go to the part of the Home screen containing that widget.

Rearranging your Home screen



Customise the appearance of your Home screen and change the features that you can access from it. Change the screen background, move items around, create folders, and add shortcuts to contacts.

To open the options menu of your Home screen



You can open the Home screen options menu in two ways:

- From your Home screen, press .
- Touch and hold on any part of your Home screen.

To add a shortcut to the Home screen

- 1 From your Home screen, press .
 - 2 Tap **Add > Shortcuts**.
 - 3 Find and select a shortcut.
-  Add an application shortcut directly from the Application screen by touching and holding the application.

To add a folder to the Home screen

- 1 From your Home screen, press .
 - 2 Tap **Add > Folder**.
 - 3 Enter a name for the folder and tap **Done**.
-  Drag and drop an item on top of another item on your Home screen to create a folder automatically.

To add items to a folder

- Touch and hold an item until it magnifies and the phone vibrates, then drag the item to the folder.

To rename a folder

- 1 Tap the folder to open it.
- 2 Touch the folder's title bar to show the **Folder name** field.
- 3 Enter the new folder name and tap **Done**.

To move an item on the Home screen

- 1 Press  to open your Home screen.
- 2 Touch and hold an item until it magnifies and the phone vibrates, then drag the item to the new location.



To delete an item from the Home screen

- Touch and hold an item until it magnifies and the phone vibrates, then drag the item to .

Changing the background of your Home screen

Adapt the Home screen to your own style using wallpapers and different themes.

To change your Home screen wallpaper

- 1 From your Home screen, press .
 - 2 Tap **Wallpaper**, then select a wallpaper.
-  You can use a photo you have taken, or an animation. Go to Android Market™ and other sources to download, for example, live wallpapers that change with the changing hours of the day.

To set a theme

- 1 From your Home screen, press .
 - 2 Tap **Theme**, then select a theme.
-  When you change a theme, the background also changes in some applications.

Accessing and using applications

Open applications from shortcuts on your Home screen or from the Application screen.

Application screen

The Application screen, which you open from your Home screen, contains the applications that come installed with your phone as well as the applications you download.

The Application screen extends beyond the regular screen width, so you need to flick left and right to view all content.

To open the Application screen

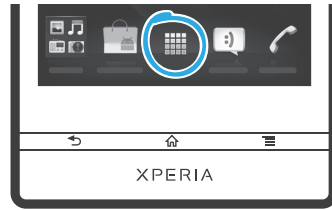

- From your Home screen, tap .



To browse the Application screen

- Open the Application screen, then flick right or left.

To create a shortcut to an application on the Home screen

- 1 From your Home screen, tap .
- 2 Touch and hold an application until it appears on your Home screen, then drag it to the desired location.

To share an application from your Application screen

- 1 From your Home screen, tap .
- 2 Touch and hold an application until it appears on your Home screen, then drag the item to .
- 3 Select an option and confirm, if necessary. You can now share the applications you like with your friends so they can download and use them.

Opening and closing applications

To open an application

- From your Home screen or the Application screen, tap the application.

To close an application

- Press .

- 💡 Some applications are paused when you press  to exit, while other applications may continue to run in the background. In the first case, the next time you open the application, you can continue where you left off.

Recently used applications window

You can view and access recently used applications from this window.

To open the recently used applications window

- Press and hold down .

Application menu

You can open a menu at any time when you are using an application by pressing the  key on your phone. The menu will look different depending on which application you are using.

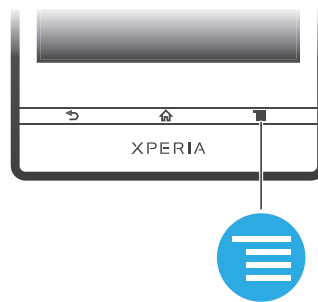



To open a menu in an application

- While using the application, press .
- ! A menu is not available in all applications.



Rearranging your Application screen

Move the applications around on the Application screen according to your preferences.

To arrange applications on the Application screen



- 1 From your Home screen, tap  to go to the Application screen.
- 2 Tap  and select an option.

To move an application on the Application screen

- 1 Open the Application screen, then tap .
- 2 Touch and hold an item until it magnifies and the phone vibrates, then drag the item to the new location.
- 3 Tap  to exit edit mode.

- ! You can only move your applications when  is selected.

To uninstall an application from the Application screen

- 1 From your Home screen, tap .
- 2 Tap . All uninstalleable applications are marked with a  icon.
- 3 Tap the application you want to uninstall, then tap **OK**.

Status and notifications

The status bar at the top of your screen shows what's going on in your phone. To the left you get notifications when there is something new or ongoing. For example, new message and calendar notifications appear here. The right side shows the signal strength, battery status, and other information.



A notification light also gives you battery status information and some notifications. For example, a flashing blue light means there is a new message or a missed call. The notification light may not work when the battery level is low.

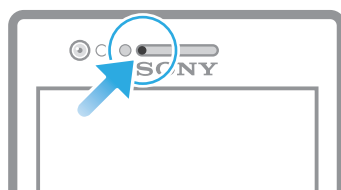

Checking notifications and ongoing activities

You can drag down the status bar to open the Notification panel and get more information. For example, you can use the panel to open a new message or view a calendar event. You can also open some applications that run in the background, such as the music player.

To open the Notification panel

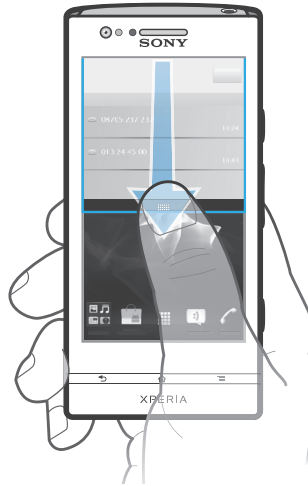

- Drag the status bar downwards.

To close the Notification panel

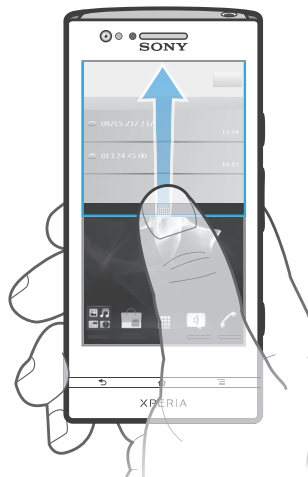

- Drag the tab at the bottom of the Notification panel upwards.

To open a running application from the Notification panel

- From the Notification panel, tap the icon for the running application to open it.

To clear the Notification panel

- From the Notification panel, tap **Clear**.

Phone settings menu

View and change your phone settings from the Settings menu.

To access the phone settings

- 1 From the Home screen, tap .
- 2 Tap **Settings**.

Typing text

On-screen keyboard

Tap the keys of the on-screen QWERTY keyboard to enter text conveniently. Some applications open the on-screen keyboard automatically. You can also open this keyboard by touching a text field.

Using the on-screen keyboard

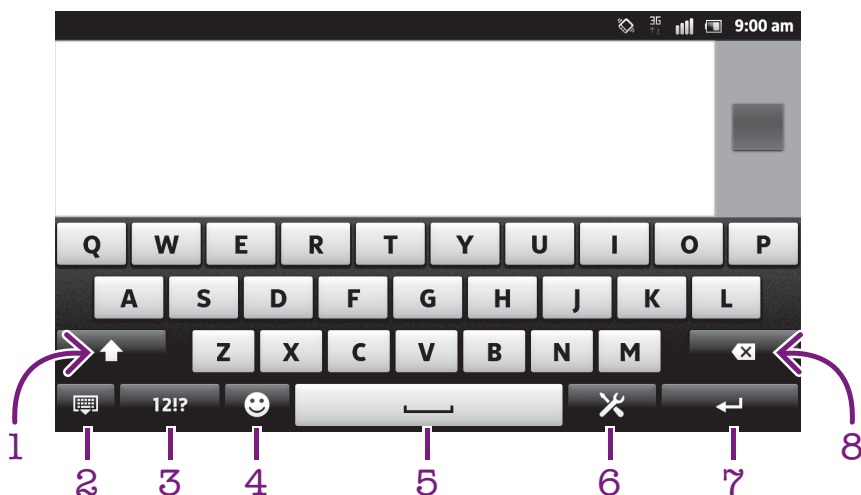

- 1 Change the character case and turn on the caps lock. For some languages, this key is used to access extra characters in the language.
- 2 Close the on-screen keyboard view. Please note that this icon does not show in portrait mode.
- 3 Display numbers and symbols.
- 4 Display smileys.
- 5 Enter a space.
- 6 Open the input settings menu to make a change, for example, under **Writing languages**. This key also changes the writing language when more than one input language is selected.
- 7 Enter a carriage return or confirm text input.
- 8 Delete a character before the cursor.

! All illustrations are for illustration purposes only and may not accurately depict the actual phone.

To display the on-screen keyboard to enter text

- Tap a text entry field.

To hide the on-screen keyboard

- When the on-screen keyboard is open, press .



To use the on-screen keyboard in landscape orientation

- When you enter text, turn the phone sideways.
- 💡 For the keyboard to support this feature, landscape mode must be supported by the application you are using, and your screen orientation settings must be set to automatic.

To enter text using the on-screen keyboard

- 1 To enter a character visible on the keyboard, tap the character.
- 2 To enter a character variant, touch and hold a regular keyboard character to get a list of available options, then select from the list. For example, to enter "é", touch and hold "e" until other options appear, then, while keeping your finger pressed on the keyboard, drag to and select "é".



To shift between upper-case and lower-case letters

- Before you enter a letter, tap  to switch to upper-case , or vice versa.

To turn on the caps lock

- Before you type a word, tap  or  until  appears.

To enter numbers or symbols

- When you enter text, tap . A keyboard with numbers and symbols appears. Tap  to view more options.

To enter common punctuation marks

- 1 When you finish entering a word, tap the space bar.
 - 2 Select a punctuation mark from the candidate bar. The selected mark is inserted before the space.
-  To quickly enter a full stop, tap the space bar twice when you finish entering a word.

To insert a smiley

- 1 When you enter text, tap .
- 2 Select a smiley.

To delete characters

- Tap to place the cursor after the character you want to delete, then tap .

To enter a carriage return

- When you enter text, tap  to enter a carriage return.

To edit text



- 1 When you enter text, touch and hold the text field until the **Edit text** menu appears.
- 2 Select an option.

Using the Gesture input function to write words

You can input text by sliding your finger from letter to letter on the on-screen keyboard. You can lift your finger between words so that the phone recognises them.

- ! **Gesture input** is only available when you use the on-screen keyboard.

To change the Gesture input settings

- 1 When you enter text using the on-screen keyboard, tap . If you have selected more than one writing language, touch and hold the input language key instead. For example, touch and hold .
- 2 Tap **Keyboard settings** > **Text input settings**.
- 3 Mark or unmark the **Gesture input** checkbox.
- 4 If you want to automatically add a space between gestures without having to tap the space bar each time, mark the **Space between gestures** checkbox.

To enter text using the Gesture input function

- 1 When you enter text using the on-screen keyboard, slide your finger from letter to letter to spell the word you want to write. Lift up your finger when you've finished entering a word.
 - 2 The phone suggests a word based on the letters you have traced. If necessary, select the correct word in the candidate bar. To view more options, scroll right or left in the word candidate bar. If you cannot find the desired word, tap once to delete the entire word. Then you can try again or tap each letter to enter the word.
 - 3 If the **Space between gestures** setting is activated, slide on the keyboard to enter the next word. Otherwise, enter a space and then slide to enter the next word.
- 💡 To enter joined compound words when the **Space between gestures** setting is activated, you may need to slide to enter the first part of the word, then tap each letter to enter the rest of the word.

Phonepad

The Phonepad is similar to a standard 12-key telephone keypad. It gives you predictive text and multi-tap input options. You can activate the Phonepad text input method via the keyboard settings. The Phonepad is only available in portrait orientation.

Using the Phonepad





- 1 Choose a text input option
- 2 Change the character case and turn on the caps lock
- 3 Display numbers
- 4 Display symbols and smileys
- 5 Enter a space
- 6 Open the input settings menu to change, for example, the **Writing languages**. This key also changes the writing language when more than one input language is selected.
- 7 Enter a carriage return or confirm text input
- 8 Delete a character before the cursor

! All illustrations are for illustration purposes only and may not accurately depict the actual phone.

To switch between the on-screen keyboard and the Phonepad

- 1 When you enter text, tap . If you have selected more than one writing language, touch and hold the input language key instead, for example, .
 - 2 Tap **Keyboard settings** > **Keyboard layout**, then select an option.
- ! The Phonepad is only available in portrait orientation.

To enter text using the Phonepad

- When  appears in the Phonepad, tap each character key only once, even if the letter you want is not the first letter on the key. Tap the word that appears or tap  to view more word suggestions and select a word from the list.
- When  appears in the Phonepad, tap the on-screen key for the character you want to enter. Keep pressing this key until the desired character is selected. Then do the same for the next character you want to enter, and so on.

To enter numbers using the Phonepad

- When the Phonepad is open, tap . A Phonepad with numbers appears.



To insert symbols and smileys using the Phonepad

- 1 When the Phonepad is open, tap . A grid with symbols and smileys appears.
- 2 Scroll up or down to view more options. Tap a symbol or smiley to select it.





Keyboard and Phonepad settings

You can select settings for the on-screen keyboard and the Phonepad, such as writing language and automatic correction.

To access the on-screen keyboard and Phonepad settings

- 1 When you enter text using the on-screen keyboard or Phonepad, tap . If you have selected more than one writing language, touch and hold the input language key instead, for example, .
- 2 Tap **Keyboard settings**.



To add a writing language to the on-screen keyboard or the Phonepad

- 1 When you enter text using the on-screen keyboard or Phonepad, tap . If you have selected more than one writing language, touch and hold the input language key instead, for example, .
- 2 Tap **Writing languages** and mark the checkbox for the languages you want to use for writing. When you have finished, press  to confirm.
- 3 To switch between languages, tap the input language key, for example, .

Text input settings

When entering text using the on-screen keyboard or the Phonepad, you can access a text input settings menu that helps you set options for text prediction. For example, you can decide how you want the phone to present word alternatives and correct words as you type, or enable the text input application to remember new words you write.

To change the text input settings





- 1 When you enter text using the on-screen keyboard or the Phonepad, tap . If you have selected more than one writing language, touch and hold the input language key instead, for example, .
- 2 Tap **Keyboard settings** > **Text input settings**.
- 3 Select the desired settings.

Entering text using voice input



When you enter text, you can use the voice input function instead of typing the words. Just speak the words that you want to enter. Voice input is an experimental technology from Google™, and is available for a number of languages and regions.

- ! You must have a data connection on a mobile or Wi-Fi® network to use this service. Additional charges may apply.



To enable voice input

- 1 When you enter text, tap . If you have selected more than one writing language, touch and hold the input language key instead, for example, .
- 2 Tap **Keyboard settings** > **Voice input fr. keyboard**.
- 3 Mark the **Google voice typing key** checkbox, read the information carefully, then tap **OK** to confirm.
- 4 To set a language for voice input, tap **Language**, then select the language you want to use.
- 5 To automatically insert the most likely word suggestion, mark the **Use best choice** checkbox.
- 6 Press  to save your settings. A microphone icon  appears on your on-screen keyboard or Phonepad.

To enter text using voice input

- 1 When you enter text, make sure that the voice input function is enabled and that you have a working data connection.
- 2 When  appears on your on-screen keyboard or Phonepad, tap it. When the input language key, for example,  appears, touch and hold it. An arrow appears. Move the arrow until it points to the microphone, then release your finger.
- 3 When **Speak now** appears on your screen, speak to enter text.
- 4 When the **Use best choice** function is activated, the most likely word suggestion appears underlined. If the word is not correct, tap  once to delete it, then start again. When the **Use best choice** function is not activated, the search results appear in a list. Select the word you want.

To access Xperia™ keyboard settings when voice input is enabled

- When  appears on your on-screen keyboard or Phonepad, touch and hold it, then select **Keyboard settings**.
- When the input language key, for example,  appears on your on-screen keyboard or Phonepad, touch and hold it. An arrow appears. Move the arrow until it points to , then release your finger.

Customising your phone

Adapt the phone to your needs by adjusting, for example, your personal ringtone, phone language and your Privacy settings.

Adjusting the volume

You can adjust the ringtone volume for phone calls and notifications as well as for music and video playback.

To adjust the ring volume with the volume key

- Press the volume key up or down.

To adjust the media playing volume with the volume key

- When playing music or watching video, press the volume key up or down.

To set the phone to silent and vibrate mode

- 1 From the Home screen, tap .
- 2 Find and tap **Settings** > **Sound**.
- 3 Mark the **Silent mode** checkbox.
- 4 Select **Vibrate** and choose an option.

To enhance the speaker loudness

- 1 From the Home screen, tap .
- 2 Find and tap **Settings** > **Sound**.
- 3 Mark the **xLOUD™** checkbox.

Time and date

You can change the time and date in your phone.

To set the date manually

- 1 From the Home screen, tap .
- 2 Find and tap **Settings** > **Date & time**.
- 3 Unmark the **Automatic** checkbox, if it is marked.
- 4 Tap **Set date**.
- 5 Adjust the date by scrolling up and down.
- 6 Tap **Set**.

To set the time manually

- 1 From your Home screen, tap .
- 2 Find and tap **Settings** > **Date & time**.
- 3 Unmark the **Automatic** checkbox, if it is marked.
- 4 Unmark the **Use 24-hour format** checkbox, if it is marked.
- 5 Tap **Set time**.
- 6 Scroll up or down to adjust the hour and minute.
- 7 Tap **am** to change to **pm**, or vice versa.
- 8 Tap **Set**.

To set the time zone

- 1 From the Home screen, tap .
- 2 Find and tap **Settings** > **Date & time**.
- 3 Unmark the **Automatic** checkbox, if it is marked.
- 4 Tap **Select time zone**.
- 5 Select an option.

To set the date format

- 1 From your Home screen, tap .
- 2 Find and tap **Settings** > **Date & time** > **Select date format**.
- 3 Select an option.

Ringtone settings

To set a phone ringtone

- 1 From your Home screen, tap .
- 2 Find and tap **Settings** > **Sound** > **Phone ringtone**.
- 3 Select a ringtone.
- 4 Tap **Done**.

To enable touch tones

- 1 From your Home screen, tap .
- 2 Find and tap **Settings** > **Sound**.
- 3 Mark the **Audible touch tones** and **Audible selection** checkboxes.

To select a notification ringtone



- 1 From your Home screen, tap .
- 2 Find and tap **Settings** > **Sound** > **Notification ringtone**.
- 3 Select a ringtone.
- 4 Tap **Done**.

To set a vibrating alert

- 1 From your Home screen, tap .
- 2 Find and tap **Settings** > **Sound**.
- 3 Select **Vibrate** and choose an option.

Screen settings



To adjust the screen brightness

- 1 From your Home screen, tap .
 - 2 Find and tap **Settings** > **Display** > **Brightness**.
 - 3 Unmark the **Automatic brightness** checkbox, if it is marked.
 - 4 Drag the slider to adjust the brightness.
 - 5 Tap **OK**.
-  You can also select the pre-configured brightness level - **Bright mode** or **Power saver mode** when you mark **Automatic brightness** checkbox.
-  The brightness level affects your battery performance. For tips on how to improve battery performance, see *Improving battery performance* on page 15.

To set the screen to vibrate

- 1 From your Home screen, tap .
- 2 Find and tap **Settings** > **Sound**.
- 3 Mark the **Haptic feedback** checkbox. The screen now vibrates when you tap soft keys and certain applications.

To adjust the idle time before the screen turns off

- 1 From your Home screen, tap .
 - 2 Find and tap **Settings** > **Display** > **Screen timeout**.
 - 3 Select an option.
-  To turn off the screen quickly, briefly press the power key .





To keep the screen on while charging the phone

- 1 From the Home screen, tap .
- 2 Find and tap **Settings** > **Applications** > **Development**.
- 3 Mark the **Stay awake** check box.

Phone language

You can select a language to use in your phone.

To change the phone language



- 1 From your Home screen, tap .
 - 2 Find and tap **Settings** > **Language & keyboard** > **Select language**.
 - 3 Select an option.
 - 4 Tap **Done**.
-  If you choose the wrong language and cannot read the menu texts, find and tap the **Settings** icon . Then select the entry beside , and select the first entry in the following menu. You can then select the language you want.

Airplane mode

In Airplane mode, your phone's network and radio transceivers are turned off to prevent disturbance to sensitive equipment. However, you can still play games, listen to music, watch videos and other content, as long as all this content is saved on your internal storage. You can also be notified by alarms, if alarms are activated.

-  Turning on Airplane mode reduces battery consumption.

To turn on Airplane mode

- 1 From your Home screen, tap .
 - 2 Find and tap **Settings** > **Wireless & networks**.
 - 3 Mark the **Airplane mode** checkbox.
-  You can also select **Airplane mode** from the **Phone options** menu. To access the **Phone options** menu, press and hold the power key .

Memory

You can save content to your phone's internal storage and to the phone memory. Music, video clips and photos are saved to the internal storage while applications, contacts and messages are saved to the phone memory.

-  You can move some applications from the phone memory to the internal storage.

To move an application to the phone's internal storage

- 1 From your Home screen, tap .
- 2 Find and tap **Settings** > **Applications** > **Manage applications**.
- 3 Select the application that you want to move to the internal storage.
- 4 Tap **Move to internal storage**.

-  It is not possible to move some applications from the phone memory to the internal storage.

Formatting the internal storage

You can format your phone's internal storage, for example, to free up memory. By doing so, you erase all data on the internal storage.

Make sure you make backups of everything that you want to save before formatting the internal storage. To back up your content, you can copy it to a computer. For more information, refer to *Connecting your phone to a computer* on page 119

To clear the internal storage

- 1 From your Home screen, tap .
- 2 Find and tap **Settings** > **Storage** > **Clear internal storage**.
- 3 Tap **Clear internal storage** > **Erase everything**.

Using a headset with your phone

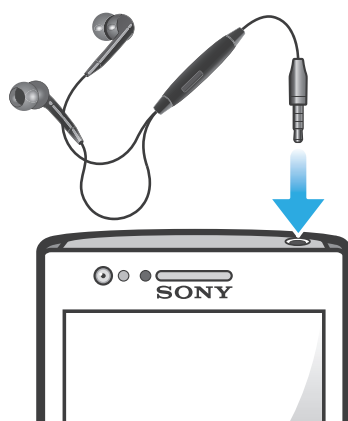

-  Use the accessories provided with your phone, or other compatible accessories, for optimal performance.

To use a headset

- 1 Connect the headset to your phone.
 - 2 To answer a call, press the call handling key.
 - 3 To end the call, press the call handling key.
- ! If a headset is not included with the phone, you may purchase one separately.
- 💡 If you are listening to music, the music stops when you receive a call and resumes when the call ends.

Internet and messaging settings

To send text and multimedia messages and to access the Internet, you must have a 2G/3G mobile data connection and the correct settings. There are different ways to get these settings:

- For most mobile phone networks and operators, Internet and messaging settings come preinstalled on your phone. You can then start using the Internet and send messages right away.
- In some cases you will get the option to download Internet and messaging settings the first time you turn on your phone. It is also possible to download these settings later from the **Settings** menu.
- You can manually add and change Internet and network settings in your phone at any time. Contact your network operator for detailed information on your Internet and messaging settings.





To download Internet and messaging settings

- 1 From your Home screen, tap .
- 2 Find and tap **Settings** > **Xperia™** > **Internet settings**.



To view the current Access Point Name (APN)

- 1 From the Home screen, tap .
 - 2 Find and tap **Settings** > **Wireless & networks** > **Mobile networks**.
 - 3 Tap **Access Point Names**.
- ! If you have several available connections, the active network connection will be indicated by a marked button to the right.

To configure APN settings manually

- 1 From the Home screen, tap .
 - 2 Find and tap **Settings** > **Wireless & networks** > **Mobile networks** > **Access Point Names**.
 - 3 Press .
 - 4 Tap **New APN**.
 - 5 Tap **Name** and enter the name of the network profile you want to create.
 - 6 Tap **APN** and enter the access point name.
 - 7 Enter all other information required by your network operator.
 - 8 Press  and tap **Save** .
- ! Contact your network operator for detailed information about your network settings.

To reset the default Internet settings

- 1 From the Home screen, tap .
- 2 Tap **Settings** > **Wireless & networks** > **Mobile networks** > **Access Point Names**.
- 3 Press .
- 4 Tap **Reset to default**.

Usage info

For quality purposes, Sony collects anonymous bug reports and statistics regarding your phone usage. None of the information gathered includes personal data. By default, the usage info sending option is not activated. But you can choose to activate it if you like.

To send usage info

- 1 From your Home screen, tap .
- 2 Find and tap **Settings > Xperia™ > Usage info settings**.
- 3 Mark the **Send usage info** checkbox.

Using Data monitor

Use the Data monitor to keep track of the amount of data your phone sends and receives. This application tracks the approximate data traffic over 2G/3G networks from a predefined start day. The values are reset monthly. For example, if the start day is set to 15, the data traffic counter is reset on the 15th day of every month. The first time you start the Data monitor, the start day is set to 1.

Get the Data monitor to alert you when the amount of transferred data reaches a certain limit. You can set limits separately for sent data, received data and total data. You can also activate the Data monitor as a widget on the Home screen.

- ! Data amounts indicated are approximate. Please consult your service provider to verify actual data usage.
- 💡 Data sent or received over Wi-Fi® or Bluetooth™ connections is not tracked.

To set the Data monitor start day

- 1 From your Home screen, tap .
- 2 Find and tap **Data monitor**.
- 3 Tap **Settings > Month period**.
- 4 Adjust the start day by scrolling up and down.
- 5 When finished, tap **OK**.

To set a Data monitor alert

- 1 From your Home screen, tap .
- 2 Find and tap **Data monitor**.
- 3 Tap the bell icon next to **Sent data**, **Received data** or **Total data**, depending on which alert you want to set.
- 4 Adjust the values by scrolling up and down.
- 5 When finished, tap **OK**.

To clear a Data monitor alert

- 1 From your Home screen, tap .
- 2 Find and tap **Data monitor**.
- 3 Tap the bell icon next to **Sent data**, **Received data** or **Total data**, depending on the alert you want to remove.
- 4 Tap **Reset**. The alert limit is reset to zero and the alert is deactivated.

Turning off data traffic

You can disable all data connections over 2G/3G networks with your phone to avoid any unwanted data downloads and synchronisations. Contact your network operator if you need detailed information about your subscription plan and data traffic costs.

- 💡 When data traffic is turned off, you can still use Wi-Fi® and Bluetooth™ connections. You can also send and receive multimedia messages.

To turn off all data traffic

- 1 From your Home screen, tap .
- 2 Find and tap **Settings > Wireless & networks > Mobile networks**.
- 3 Unmark the **Data enabled** checkbox.

Data roaming

Depending on your network operator, it might be possible to allow mobile data connections via 2G/3G outside of your home network (roaming). Please note that data transmission charges may apply. Contact your network operator for more information.

- ! Applications may sometimes use the Internet connection in your home network without any notification, for example, when sending search and synchronisation requests. Additional charges may apply for data roaming. Consult your service provider.

To activate data roaming

- 1 From the Home screen, tap .
 - 2 Find and tap **Settings > Wireless & networks > Mobile networks**.
 - 3 Mark the **Data roaming** checkbox.
- ! You can't activate data roaming when data connections have been deactivated

Network settings

Your phone automatically switches between networks depending on available networks over different locations. Initially, your phone is configured to use the fastest mobile network mode available for data. But you can configure your phone manually to use only a slower 2G network mode for data, to extend the life of your battery between charges. You can also configure your phone to access a different set of network modes entirely, or to behave in special ways when roaming.

To select a network mode

- 1 From your Home screen, tap .
- 2 Find and tap **Settings > Wireless & networks > Mobile networks**.
- 3 Tap **Network Mode**.
- 4 Select a network mode.

To select another network manually

- 1 From the Home screen, tap .
 - 2 Find and tap **Settings > Wireless & networks > Mobile networks > Network operators**.
 - 3 Tap **Search mode**.
 - 4 When a popup window appears, tap **Manual**.
 - 5 Select a network.
- ! If you select a network manually, your phone will not search for other networks, even if you move out of range of the manually selected network.

To activate automatic network selection

- 1 From the Home screen, tap .
- 2 Find and tap **Settings > Wireless & networks > Mobile networks > Network operators**.
- 3 Tap **Search mode**.
- 4 Tap **Automatic**.

Calling

Emergency calls

Your phone supports international emergency numbers, for example, 112 or 911. You can normally use these numbers to make emergency calls in any country, with or without the SIM card inserted, if you are within range of a network.

To make an emergency call

- 1 From your Home screen, tap .
- 2 Find and Tap **Phone**.
- 3 Enter the emergency number and tap **Call**. To delete a number, tap .

- 💡 You can make emergency calls when no SIM card is inserted or when outgoing calls are barred.



To make an emergency call while the SIM card is locked

- 1 Tap **Emergency call**.
- 2 Enter the emergency number and tap **Call**. To delete a number, tap .

Call handling

You can make a call by manually dialling a phone number, by tapping a number saved in your phone's contact list, or by tapping the phone number in your call log view.

To make a call by dialling

- 1 From your Home screen, tap .
- 2 Find and tap **Phone**.
- 3 Enter the number of the recipient and tap **Call**. To delete a number, tap .

To end a call

- Tap **End call**.

To make an international call

- 1 From your Home screen, tap .
- 2 Find and tap **Phone**.
- 3 Touch and hold 0 until a "+" sign appears.
- 4 Enter the country code, area code (without the first 0) and phone number, then tap **Call**.

To answer a call



- Drag  to the right across the screen.
- ! If you are using regular headphones without a microphone, you have to remove the headphones from the headset connector to be able to answer the call.

To decline a call

- Drag  to the left across the screen.

To change the ear speaker volume during a call

- Press the volume key up or down.

To turn on the loudspeaker during a call

- Tap .

To mute the microphone during a call

- Tap .

To activate the screen during a call

- Press .

To enter numbers during a call

- 1 During a call, tap . A keypad appears.
- 2 Enter numbers.

To mute the ringtone for an incoming call

- When you receive the call, press the volume key.

Recent calls

In the call log, you can view recently missed , received  and dialled  calls.

To view your missed calls

- 1 When you have missed a call,  appears in the status bar. Drag the status bar downwards.
- 2 Tap **Missed call**.

To call a number from your call log

- 1 From your Home screen, tap .
- 2 Find and tap **Phone**. The call log view appears on the upper part of the screen.
- 3 To call a number directly, tap the number. To edit a number before calling, touch and hold the number, then tap **Edit number before call**.

- ! You can also call a number by tapping  > **Call back**.

To add a number from the call log to your contacts

- 1 From your Home screen, tap .
- 2 Find and tap **Phone**. The call log view appears on the upper part of the screen.
- 3 Touch and hold the number, then tap **Add to contacts**.
- 4 Tap the desired contact, or tap **Create new contact**.
- 5 Edit the contact details and tap **Done**.

Voicemail

If your subscription includes a voicemail service, callers can leave voice messages for you when you can't answer calls. Your voicemail service number is normally saved on your SIM card. If not, you can get the number from your service provider and enter it manually.

To enter your voicemail number

- 1 From the Home screen, tap .
- 2 Find and tap **Settings** > **Call settings** > **Voicemail settings** > **Voicemail number**.
- 3 Enter your voicemail number.
- 4 Tap **OK**.

To call your voicemail service

- 1 From your Home screen, tap .
- 2 Find and tap **Phone**.
- 3 Touch and hold 1.

Multiple calls

If you have activated call waiting, you can handle multiple calls at the same time. When it is activated, you will be notified by a beep if you receive another call.

To activate or deactivate call waiting

- 1 From the Home screen, tap .
- 2 Find and tap **Settings** > **Call settings** > **Additional settings**.
- 3 To activate or deactivate call waiting, tap **Call waiting**.

To reject a second call

- When you hear repeated beeps during a call, tap **Busy**.



To answer a second call and end the ongoing call

- When you hear repeated beeps during a call, tap **End current call and answer**.

To answer a second call and put the ongoing call on hold

- When you hear repeated beeps during a call, tap **Answer**.

To make a second call

- 1 During an ongoing call, tap .
- 2 Enter the number of the recipient and tap .
- 3 If the recipient answers, the first call is put on hold.

- 💡 The same procedure applies to subsequent calls.

To switch between multiple calls

- To switch to another call and put the current call on hold, tap the desired number or contact.



To end the ongoing call and return to the next call on hold

- Tap .

Conference calls

With a conference or multiparty call, you can have a joint conversation with two or more persons.

To make a conference call

- 1 During an ongoing call, tap .
- 2 Dial the number of your second participant and tap .
- 3 If the second participant answers, the first call is put on hold.
- 4 Tap .

- 💡 To add more participants, repeat steps 1 to 4.

To have a private conversation with a conference call participant

- 1 During an ongoing conference call, tap the button showing the number of participants. For example, tap **3 participants** if there are three participants on the call.
- 2 Tap the name of the participant you want to talk to privately.
- 3 To end the private conversation and return to the conference call, tap .

To release a participant from a conference call

- 1 During an ongoing conference call, tap the button showing the number of participants. For example, tap **3 participants** if there are three participants.
- 2 Tap  next to the participant you want to release.

To end a conference call

- During the conference call, tap **End conference call**.

Call settings

Barring calls

You can bar all or certain categories of incoming and outgoing calls. When you use call barring for the first time, you need to enter your PUK (Personal Unblocking Key) and then a new password to activate the call barring function.

To bar incoming or outgoing calls

- 1 From your Home screen, tap .
- 2 Find and tap **Settings** > **Call settings** > **Call barring**.
- 3 Select an option.
- 4 Enter the password and tap **Enable**.

Forwarding calls

You can forward calls, for example, to another phone number, or to an answering service.

To forward calls

- 1 From your Home screen, tap .
- 2 Find and tap **Settings** > **Call settings** > **Call forwarding**.
- 3 Select an option.
- 4 Enter the number you want to forward the calls to, then tap **Enable**.

To turn off call forwarding

- 1 From your Home screen, tap .
- 2 Find and tap **Settings** > **Call settings** > **Call forwarding**.
- 3 Select an option, then tap **Disable**.

Showing or hiding your phone number

You can select to show or hide your phone number on call recipients' devices when you call them.

To show or hide your phone number

- 1 From your Home screen, tap .
- 2 Find and tap **Settings** > **Call settings** > **Additional settings** > **Caller ID**.

Fixed Dialling Numbers

If you have received a PIN2 code from your service provider, you can use a list of Fixed Dialling Numbers (FDN) to restrict outgoing calls.

To enable or disable fixed dialling

- 1 From your Home screen, tap .
- 2 Find and tap **Settings** > **Call settings** > **Fixed Dialling Numbers**.
- 3 Tap **Activate fixed dialling** or **Deactivate fixed dialling**.
- 4 Enter your PIN2 and tap **OK**.

To access the list of accepted call recipients

- 1 From your Home screen, tap .
- 2 Find and tap **Settings** > **Call settings** > **Fixed Dialling Numbers** > **Fixed Dialling Numbers**.

Contacts

Use the Contacts application to store and manage all your numbers, email addresses, and other contact data in one place. Just tap on a contact to see all communications with that contact in one easy overview.

You can add new contacts in your phone and synchronise them with contacts saved in your Google™ account, Microsoft® Exchange ActiveSync® account, or other accounts that support synchronisation. The Contacts application automatically creates new entries and also helps you match data such as email addresses with existing entries. You can also manage this process manually. For more information, go to www.sonymobile.com.

Transferring contacts to your new phone



There are several ways to transfer contacts to your new phone. Select a transfer method that best suits your situation.

Transferring contacts using a PC

You can use a PC to transfer contacts from several phone brands, including iPhone, Samsung, HTC and Nokia.

You need:

- An Internet-connected PC running Windows®
- A USB cable for your old phone
- A USB cable for your new Android™ phone
- Your old phone
- Your new Android™ phone

! If you don't have access to all of the items listed above, go to www.sonymobile.com to find out about other ways to transfer your contacts.

Using the PC Companion program to transfer contacts

If you are transferring contacts using a PC, use the PC Companion program. It's free, and the installation files are already saved on your new phone. PC Companion also offers a range of other features, including help to update your phone software.

To install PC Companion

- 1 **New phone:** Turn on your new Android™ phone and connect it to a PC using a USB cable.
- 2 **New phone:** Tap **Install** to install PC Companion on the PC.
- 3 **Computer:** If a popup window appears, select *Run Startme.exe*. In the new popup window that appears, click *Install* to start the installation and then follow the instructions to complete the installation.

To transfer contacts to your new phone using PC Companion

- 1 Make sure that PC Companion is installed on your PC.
- 2 Open the PC Companion program on the PC, then click *Contacts Setup* and follow the instructions to transfer your contacts.





Transferring contacts using an Apple® Mac® computer

For detailed instructions on how to use an Apple Mac computer to transfer contacts from your old phone, go to www.sonymobile.com.





Transferring contacts using synchronisation accounts

Your phone works with popular online synchronisation accounts such as Google Sync™, Microsoft® Exchange ActiveSync® or Facebook™. If you have synced the contacts in your old phone or your computer with an online account, you can transfer your contacts to your new phone using that account. For more detailed information about synchronisation, see *Synchronising data on your phone* on page 68.

To synchronise your phone contacts with a synchronisation account

- 1 From your Home screen, tap , then tap .
- 2 Press , then tap **Settings > Accounts & sync**.
- 3 To set up a synchronisation account, tap **Add account** and follow the on-screen instructions. If you have already set up a synchronisation account and you want to sync with that account, tap the account, press , and tap **Sync now**.

To import contacts from a SIM card

- 1 From your Home screen, tap , then tap .
- 2 Press , then tap **Import contacts > SIM card**.
- 3 If you have set up a synchronisation account, you can choose to add the SIM card contacts under that account. Or you can choose to only use these contacts in the phone. Select your desired option.
- 4 To import an individual contact, find and tap the contact. To import all contacts, press , then tap **Import all**.

To receive contact data sent using Bluetooth™ technology

- 1 Make sure you have the Bluetooth™ function turned on and your phone set to visible. If not, then you cannot receive data from other devices.
- 2 When you are asked to confirm whether you want to receive the file, tap **Accept**.
- 3 Drag down the Notification panel and tap the file you received to import the contact data.

To receive contacts sent using a messaging service

- 1 When you receive a new text message, multimedia message, or email message, open the message.
- 2 The received contact data appears as a vCard attachment. Tap, or touch and hold the vCard file to open a menu so you can save the contact data.

Contacts screen overview

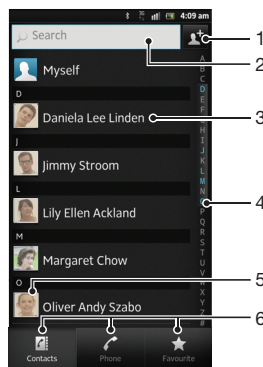

- 1 Tap here to create a contact
- 2 Contact search field

- 3 Touch a contact to view its details
- 4 Alphabetical index for browsing contacts
- 5 Tap a contact thumbnail to access the Quick Contact menu
- 6 Shortcut tabs

Managing your contacts

You can create, edit and synchronise your contacts in a few simple steps. You can select contacts saved in different accounts and manage how you display them in the phone.



If you synchronise your contacts with more than one account, you can join contacts in your phone to avoid duplicates.

- ! Some synchronisation services, for example, some social networking services, do not allow you to edit contact details.



To view your contacts

- From your Home screen, tap , then tap . Your contacts are listed here.



To select which contacts to display in the Contacts application

- 1 From your Home screen, tap , then tap .
- 2 Press , then tap **Filter**.
- 3 In the list that appears, mark and unmark the desired options. If you have synchronised your contacts with a synchronisation account, that account appears in the list. To further expand the list of options, tap the account.
- 4 When you are finished, tap **OK**.



To add a contact

- 1 From your Home screen, tap , then tap .
 - 2 Tap .
 - 3 If you have synchronised your contacts with one or more accounts, select the account to which you want to add this contact, or tap **Phone contact** if you only want to use this contact in your phone.
 - 4 Enter or select the desired information for the contact.
 - 5 When you are finished, tap **Done**.
- 💡 If you add a plus sign and the country code before a contact phone number, you can use the number when you make calls from other countries.

To edit a contact



- 1 From the Home screen, tap , then tap .
- 2 Touch and hold the contact you want to edit, then tap **Edit contact**.
- 3 Edit the desired information. When you are finished, tap **Done**.

To associate a picture with a contact



- 1 From your Home screen, tap , then tap .
- 2 Touch and hold the contact you want to edit, then tap **Edit contact**.
- 3 Tap  and select the desired method for adding the contact picture.
- 4 When you have added the picture, tap **Done**.

- 💡 You can also add a picture to a contact directly from the **Gallery** application.



To view your communication with a contact

- 1 From the Home screen, tap , then tap .
- 2 Tap the contact you want to view.
- 3 To view your communication with the contact for different media, tap or flick through the filter items at the bottom of the screen.

To delete contacts

- 1 From your Home screen, tap , then tap .
- 2 Press , then tap **Delete contacts**.
- 3 Mark the contacts you want to delete, or tap **Mark all** if you want to delete all contacts.
- 4 Tap **Delete > OK**.



To edit contact information about yourself

- 1 From your Home screen, tap , then tap .
- 2 Touch and hold **Myself** at the top of the contact list, then tap **Edit contact**.
- 3 Enter the new information or make the changes you want.
- 4 When you are done, tap **Done**.



Avoiding duplicate entries in the Contacts application

If you synchronise your contacts with a new account or import contact information in other ways, you could end up with duplicate entries in the Contacts application. If this happens, you can join such duplicates to create a single entry. And if you join entries by mistake, you can separate them again later.

To link contacts

- 1 From your Home screen, tap , then tap .
- 2 Touch and hold the contact you want to link with another contact, then tap **Link contact**.
- 3 From the list that appears, tap the contact whose information you want to join with the first contact, then tap **OK** to confirm. The information from the first contact is merged with the second contact, and the first contact is no longer displayed in the Contacts list.



To separate linked contacts

- 1 From your Home screen, tap , then tap .
- 2 Touch and hold the linked contact you want to edit, then tap **Edit contact**.
- 3 Tap **Unlink contact**.
- 4 Tap **OK**.

Favourites



You can mark a contact as a favourite. The **Favourites** tab gives you quick access to your marked contacts. In **Favourites**, you can also find a list of the contacts you communicate with most frequently.

To mark or unmark a contact as a favourite

- 1 From the Home screen, tap , then tap .
- 2 Tap the contact you want to add to or remove from your favourites.
- 3 Tap .

Communicating with your contacts

To search for a contact

- 1 From your Home screen, tap , then tap .
- 2 Enter the first few letters of the contact name in the **Search** field. All contacts beginning with those letters appear.

The quick contact menu



Tap a contact's thumbnail to view quick communication options for a particular contact. Options include calling the contact, sending a text or multimedia message, and starting a chat using the Google Talk™ application.

- ! For an application to appear as an option in the quick contact menu, you may need to set up the application in your phone and be logged in to the application. For example, you need to



start the Gmail™ application and enter your login details before you can use Gmail™ from the quick contact menu.

Sharing your contacts



To send your business card

- 1 From your Home screen, tap , then tap .
- 2 Tap **Myself**.
- 3 Press , then tap **Send contact > OK**.
- 4 Select an available transfer method and follow the on-screen instructions.

To send a contact

- 1 From your Home screen, tap , then tap .
- 2 Tap the contact whose details you want to send.
- 3 Press , then tap **Send contact > OK**.
- 4 Select an available transfer method and follow the on-screen instructions.

To send several contacts at once

- 1 From your Home screen, tap , then tap .
- 2 Press , then tap **Send contacts**.
- 3 Mark the contacts you want to send, or select all if you want to send all contacts.
- 4 Tap **Send**, then tap **OK** to confirm.
- 5 Select an available transfer method and follow the on-screen instructions.



Backing up contacts

You can use internal storage, a SIM card or an online synchronisation tool such as Microsoft® Exchange ActiveSync® to back up contacts.

To export all contacts to the phone's internal storage



- 1 From your Home screen, tap , then tap .
- 2 Press , then tap **Back up contacts > Internal storage**.
- 3 Tap **OK**.

To export contacts to a SIM card

- 1 From your Home screen, tap , then tap .
- 2 Press , then tap **Back up contacts > SIM card**.
- 3 Mark the contacts you want to export, or tap **Mark all** if you want to export all your contacts.
- 4 Tap **Back up**.
- 5 Select **Add contacts** if you want to add the contacts to existing contacts on your SIM card, or select **Replace all contacts** if you want to replace the existing contacts on your SIM card.

- ! When you export contacts to a SIM card, not all information may get exported. This is due to memory limitations on SIM cards.

To export all contacts to the USB storage

- 1 From your Home screen, tap , then tap .
- 2 Press , then tap **Back up contacts > USB storage**.
- 3 Tap **OK**.





Messaging

Using text and multimedia messaging

You can send and receive text messages from your phone using SMS (Short Message Service). If your subscription includes MMS (Multimedia Messaging Service), you can also send and receive messages that contain media files, for example, pictures and videos. A single text message may contain up to 160 characters. If you exceed 160 characters, then all your single messages are linked and sent together. You are charged for each 160-character message sent. When you view your messages, they appear as conversations, which means that all messages to and from a particular person are grouped together.



- ! To send multimedia messages, you need the correct MMS settings in your phone. See *Internet and messaging settings* on page 32.

To create and send a message

- 1 From your Home screen, tap , then find and tap .
- 2 Tap .
- 3 To add a recipient, tap , then find and mark the checkbox next to the recipient name. To add more than one recipient, mark the checkboxes for the desired recipients. You can also enter the full number in the search field manually, then tap **Add**.
- 4 When you are finished adding recipients, tap **Done**.
- 5 Tap **Write message** and enter your message text.
- 6 If you want to add a media file, tap  and select an option.
- 7 To send the message, tap **Send**.

- 💡 If you exit a message before sending, it gets saved as a draft. The conversation gets tagged with the word **Draft**.

To read a received message



- 1 From your Home screen, tap , then find and tap .
- 2 Tap the desired conversation.
- 3 If the message is not yet downloaded, tap and hold the message, then tap **Download message**.

- 💡 You can also open messages from the status bar when  appears there. Just drag down the bar and tap the message.



To reply to a message

- 1 From your Home screen, tap , then find and tap .
- 2 Tap the conversation containing the message.
- 3 Enter your reply and tap **Send**.



To forward a message

- 1 From your Home screen, tap , then find and tap .
- 2 Tap the conversation containing the message you want to forward.
- 3 Touch and hold the message you want to forward, then tap **Forward message**.
- 4 Select a recipient from the list, or tap  to add a recipient who is not in the list.
- 5 Edit the message and tap **Send**.





To delete a message

- 1 From your Home screen, tap , then find and tap .
- 2 Tap the conversation containing the message you want to delete.
- 3 Touch and hold the message you want to delete, then tap **Delete message** > **Yes**.



To delete conversations

- 1 From your Home screen, tap , then find and tap .
- 2 Press , then tap **Delete several**.
- 3 Mark the checkboxes for the conversations you want to delete, then tap **Delete**.



To save a message sender's number

- 1 From your Home screen, tap , then find and tap .
- 2 Tap a conversation.
- 3 Press , then tap **Add to Contacts**.
- 4 If you want to add the number to an existing contact, select the relevant contact. Or tap  if you want to create a new contact.
- 5 Select the account to which you want to save the contact.
- 6 Edit the contact information and tap **Done**.





To call a message sender

- 1 From your Home screen, tap , then find and tap .
- 2 Tap a conversation.
- 3 Tap the recipient name or number at the top of the screen, then select the recipient name or number from the list that appears.
- 4 If the recipient is saved in your contacts, tap the phone number that you want to call. If you have not saved the recipient in your contacts, tap .



To save a file contained in a message you receive

- 1 From your Home screen, tap , then find and tap .
- 2 Tap the conversation you want to open.
- 3 If the message has not been downloaded yet, tap and hold the message, then tap **Download message**.
- 4 Touch and hold the file you want to save, then select the desired option.





To star a message

- 1 From your Home screen, tap , then find and tap .
- 2 Tap the conversation you want to open.
- 3 In the message you want to star, tap .
- 4 To unstar a message, tap .

To view starred messages



- 1 From your Home screen, tap , then find and tap .
- 2 Press , then tap **Starred messages**.
- 3 All starred messages appear in a list.

To search for messages



- 1 From your Home screen, tap , then find and tap .
- 2 Press , then tap **Search**.
- 3 Tap **Search Messaging**.
- 4 Enter your search keywords, then tap .

Text and multimedia message options

To change your message notification settings



- 1 From your Home screen, tap , then find and tap .
- 2 Press , then tap **Settings**.
- 3 To set a notification sound, tap **Notification tone** and select an option.
- 4 For other notification settings, check or uncheck the relevant checkboxes.

To change the delivery report settings for outgoing messages

- 1 From your Home screen, tap , then find and tap .
- 2 Press , then tap **Settings**.
- 3 Tap **Delivery report** to activate or deactivate delivery reports.

! When a message has been delivered to a recipient,  appears in the message.

To view messages saved on the SIM card

- 1 From your Home screen, tap , then find and tap .
- 2 Press , then tap **Settings** > **SIM messages**.

Email

Use the Email application in your phone to send and receive emails through your regular email account or through your corporate account. Or you can do both. Your phone can handle several email accounts at the same time. You can set up these accounts to run through one combined inbox, or through separate inboxes. Note that emails you receive to your Gmail™ account can be accessed in the phone from both the Email and the Gmail™ applications.

- 💡 Your corporate Microsoft® Outlook® email messages have to be stored on a Microsoft® Exchange server for the functionality described above to work. See *Synchronising your corporate email, calendar and contacts* on page 68 for more information.









To set up an email account in your phone

- 1 From your Home screen, tap .
- 2 Find and tap **Email**.
- 3 Enter your email address and password, then tap **Next**.
- 4 If the settings for the email account cannot be downloaded automatically, complete the setup manually. If necessary, contact your email service provider for detailed settings. For corporate email setup on your phone, select **Exchange Active Sync** as the account type.
- 5 When you are prompted, enter a name for your email account, so that it is easily identifiable. The same name shows in the emails you send from this account. When you are finished, tap **Done**.



- 💡 You can set up more than one email account. See *To add an extra email account in your phone* on page 50.

Using email

To create and send an email message

- 1 From your Home screen, tap , then find and tap **Email**.
- 2 If you are using several email accounts, tap the account you want to send the message from, then tap .
- 3 Tap **To** and start typing the recipient's address. Matches are displayed in a dynamic list. Tap the relevant match or continue typing the complete email address. To add more recipients, enter a comma (,) or a semi colon (;) and start typing another name. To delete a recipient, tap the  key.
- 4 To select an email address saved in your contacts, tap , then find and mark the checkbox next to a recipient field. To add more than one recipient, mark the checkboxes for the desired recipients. When you are finished, tap **Done**.
- 5 Tap **Subject** and enter the email subject.
- 6 To attach a file, tap . Select the type of file, then tap the file you want to attach from the list that appears.
- 7 In the message area, enter your message text.
- 8 To set a priority level, press , then tap **Set priority** and select an option.
- 9 To add Cc/Bcc fields, press , then tap **Add Cc/Bcc**.
- 10 To send the email, tap .

To receive email messages



- 1 From your Home screen, tap .
- 2 Tap **Email**.
- 3 If you are using several email accounts, tap the account that you want to check. If you want to check all your email accounts at once, tap **Combined Inbox**.
- 4 To download new messages, press , then tap **Refresh**.

- 💡 If you have set up a corporate email account, you can set the checking frequency to **Automatic (Push)**.





To read your email messages

- 1 From your Home screen, tap .
- 2 Find and tap **Email**.
- 3 If you are using several email accounts, tap the account you want to check. If you want to check all your email accounts at once, tap **Combined Inbox**.
- 4 In the email inbox, scroll up or down and tap the email you want to read.



To use the email preview pane

- 1 From your Home screen, tap , then find and tap **Email**.
 - 2 If you are using several email accounts, tap the account you want to check. If you want to check all your email accounts at once, tap **Combined Inbox**.
 - 3 Hold your phone horizontally. The email preview pane appears.
 - 4 Scroll up or down in the email inbox and tap the email you want to read. The email opens in the preview pane. To view more information about the email, tap the downward arrow next to the sender's name. In the body text field, pinch two fingers together, or spread them apart, to zoom in or out.
 - 5 To view the email in fullscreen format, drag the split bar (located between the email list and email body) accordingly. In fullscreen format, use the upward and downward arrows at the bottom of the screen to read your previous or next message.
 - 6 To return to the inbox view, drag the split bar accordingly.
-  To hide the preview pane, hold your phone vertically, or change the preview pane settings.

To change email preview pane settings

- 1 From your Home screen, tap , then find and tap **Email**.
 - 2 If you are using several email accounts, tap the account you want to check.
 - 3 Press , then tap **More** > **Preview pane** and select an option.
-  To change email preview pane settings when you're using the combined inbox, press , then tap **Preview pane** and select an option.



To view an email message attachment

- 1 From your Home screen, tap .
- 2 Find and tap **Email**.
- 3 Find and tap the desired message in your email inbox. Emails with attachments are identified by .
- 4 Tap the downward arrow beside the sender's name, tap an attachment, and select **Open** or **Save**.



To save a sender's email address to your contacts

- 1 From your Home screen, tap .
- 2 Find and tap **Email**.
- 3 Find and tap the desired message in your email inbox.
- 4 Tap the name of the sender at the top of the screen.
- 5 Tap **OK** when you are prompted to add the name to your contacts.
- 6 Select an existing contact, or tap **Create new contact** if you want to create a new contact.
- 7 Edit the contact information and tap **Done**.

To reply to an email message

- 1 From your Home screen, tap .
- 2 Tap **Email**.
- 3 In your email inbox, touch and hold the message you want to reply to.
- 4 Tap **Reply** or **Reply all**.
- 5 Enter your reply, then tap .

To forward an email message

- 1 From your Home screen, tap .
- 2 Tap **Email**.
- 3 In your email inbox, touch and hold the message you want to forward.
- 4 Tap **Forward**.
- 5 Tap **To** and enter the recipient's address. Or tap  to select a recipient from your contacts.
- 6 Enter your message text, then tap .





To delete an email message

- 1 From your Home screen, tap .
- 2 Tap **Email**.
- 3 In your email inbox, touch and hold the message you want to delete, then tap **Delete**.



To sort your emails



- 1 From your Home screen, tap .
- 2 Tap **Email**.
- 3 If you are using several email accounts, tap the account that you want to check. If you want to check all your email accounts at once, tap **Combined Inbox**.
- 4 Press , then tap **Sort**.
- 5 Select a sorting option.

To search for emails



- 1 From your Home screen, tap .
- 2 If you are using several email accounts and want to check just one account, tap the account name. Press , then tap **Search**.
- 3 Tap **Search keyword**, enter your search text, then tap .
- 4 The search result appears in a list sorted by date. Tap the email you want to open.
- 5 To change search options, tap  and select a different option.

To manage your email in batches



- 1 From your Home screen, tap .
- 2 If you are using several email accounts, tap the account that you want to check. If you want to check all your email accounts at once, tap **Combined Inbox**.
- 3 Press , then tap **Mark several**.
- 4 Mark the checkboxes for the emails that you want to select.
- 5 When you are finished, tap one of the icons at the bottom of the screen to, for example, delete the selected emails. You can also mark them as read or unread. For more options, press .

-  In an Exchange Active Sync account, you can also tap  to move selected emails to another folder.

To view all folders for one email account

- 1 From your Home screen, tap .
- 2 If you are using several email accounts, tap the account you want to check.
- 3 Press , then tap **Folders** to view all the folders in this account.

To change the inbox checking frequency



- 1 From your Home screen, tap .
- 2 Find and tap **Email**.
- 3 If you are using several email accounts, tap and hold the account you want to adjust, then tap **Account settings**. If you are viewing the inbox of one account, press , then tap **More > Account settings**.
- 4 Tap **Inbox check frequency** and select an option.

To set an Out of Office auto-reply in an Exchange Active Sync account



- 1 From your Home screen, tap , then find and tap **Email**.
- 2 If you are using several email accounts, touch and hold the desired EAS (Exchange Active Sync) account, then select **Account settings** > **Out of office**.
- 3 Mark the **Out of office** checkbox.
- 4 If needed, mark the **Set time range** checkbox and set the time range for the auto reply.
- 5 Enter your Out of Office message in the body text field.
- 6 Tap **OK** to confirm.

Using email accounts



To add an extra email account in your phone

- 1 From your Home screen, tap .
- 2 Find and tap **Email**.
- 3 If you have more than one email account in your phone, all accounts appear in a list. If you only have one email account in your phone, press , then tap **More** > **Accounts**.
- 4 Press , then tap **Add account**.
- 5 Enter the email address and password, then tap **Next**. If the settings for the email account cannot be downloaded automatically, complete the setup manually.
- 6 When prompted, enter a name for your email account so that it is easily identifiable. The same name shows in the emails you send from this account.
- 7 When you are finished, tap **Done**.

To set an email account as your default account

- 1 From your Home screen, tap .
 - 2 Find and tap **Email**.
 - 3 Tap and hold the account you want to use as the default account for composing and sending email, then tap **Account settings**.
 - 4 Mark the **Default account** checkbox.
-  If you only have one email account, this account is automatically the default account.

To remove an email account from your phone



- 1 From your Home screen, tap .
- 2 Find and tap **Email**.
- 3 If you have several email accounts in your phone, go to step 4. If you only have one email account, press , then tap **More** > **Accounts**.
- 4 Touch and hold the account you want to remove, then tap **Remove account** > **OK**.

Gmail™ and other Google™ services

If you have a Google™ account, you can use the Gmail™ application in your phone to read, write and organise email messages. After you set up your Google™ account to work in the phone, you can also chat to friends using the Google Talk™ application, synchronise your phone calendar application with your Google Calendar™, and download applications and games from Android Market™.

-  The services and features described in this chapter may not be supported in all countries or regions, or by all networks and/or service providers in all areas.

To set up a Google™ account in your phone

- 1 From your Home screen, tap .
 - 2 Find and tap **Settings** > **Accounts & sync** > **Add account** > **Google**.
 - 3 Follow the registration wizard to create a Google™ account, or sign in if you already have an account. Your phone is now ready to use with Gmail™, Google Talk™ and Google Calendar™.
-  You can also sign in or create a Google™ account from the setup guide the first time you start your phone. Or you can go online and create an account at www.google.com/accounts.

To open the Gmail™ application

- 1 From the Home screen, tap .
- 2 Find and tap **Gmail™**.

Google Talk™

You can use Google Talk™ instant messaging in your phone to chat with friends who also use this application.

To start Google Talk™

- 1 From your Home screen, tap .
- 2 Find and tap **Talk**.

To reply to an instant message with Talk



- 1 When someone contacts you on **Talk**,  appears in the status bar.
- 2 Drag the status bar downwards, then tap the message and begin to chat.

Timescape™

Timescape™ collects all your communications into one integrated view. Events such as Facebook™ or Twitter™ updates appear as tiles in a chronological flow on the screen. Browse the files to get a snack-size preview of events before choosing to open them and view the full content. Timescape™ also features an infinite button  that gives you access to a range of content about the item you are currently viewing.

- ! The services and features described in this chapter may not be supported in all countries or regions, or by all networks and/or service providers in all areas.

To start Timescape™

- 1 From your Home screen, tap .
- 2 Find and tap **Timescape™** .
- 3 If you are starting Timescape™ for the first time, tap the tile in the welcome screen to set up Timescape.
- 4 Tap the **Services** screen to log in to social networking services such as Facebook™ or Twitter™, or to search for Timescape-related extensions on Android Market™.
- 5 If you do not want to log in to any social networking accounts or search Android Market™, tap **Done**.

Timescape™ main view

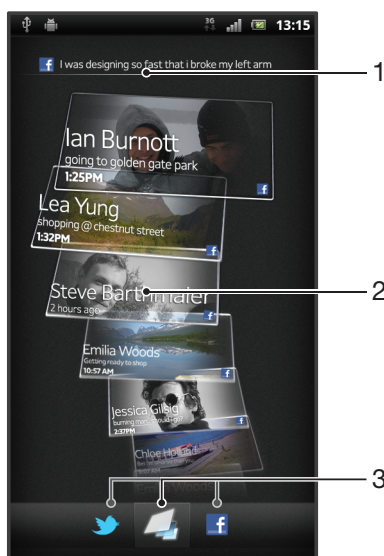

- 1 Your status on the web services you have selected
- 2 Timescape™ tiles, in chronological order, with the most recent tile at the top
- 3 Timescape™ event filter

Using Timescape™

To scroll through tiles in Timescape™

- 1 From your Home screen, tap .
- 2 Find and tap **Timescape™**.
- 3 Flick up or down to scroll through the tiles.

To preview a tile in Timescape™

- 1 From your Home screen, tap .
- 2 Find and tap **Timescape™**.
- 3 Scroll to the tile you want to preview, and then tap it.

Timescape™ event filter overview

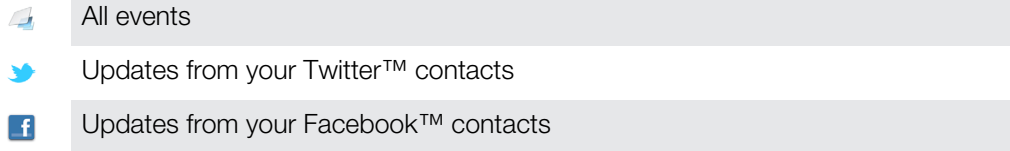

- 💡 More events appear in the Timescape™ event filter if you have installed other Timescape services.



To filter the events displayed in Timescape™

- 1 From your Home screen, tap .
- 2 Find and tap **Timescape™**.
- 3 Tap or flick through the filter icons.

To refresh the main view in Timescape™



- When the Timescape™ event filter is set to show all events, press , then tap **Refresh**.
- 💡 When you refresh the main view, your phone may connect to the Internet to update information from web service accounts that you have linked to Timescape™.

To log in to Facebook™ or Twitter™ from Timescape™



- 1 From your Home screen, tap .
- 2 Find and tap **Timescape™**.
- 3 Press , then tap **Settings > Set up services**.
- 4 Tap the service you want to log in to.
- 5 Enter your login details.

- 💡 When you have logged in to a web service, you can update your status or view updates from the web service in Timescape™.

To update your Facebook™ or Twitter™ status in Timescape™

- 1 From your Home screen, tap .
- 2 Find and tap **Timescape™**.
- 3 Tap  > **Update status**.
- 4 Tap the service for which you want to update your status. If you are not signed in to the service, you need to sign in before proceeding. When you have selected the desired service, tap **Continue**.
- 5 Tap the text field and enter your new status, then tap **Post**.

To log out of Facebook™ or Twitter™ from Timescape™

- 1 From your Home screen, tap .
- 2 Find and tap **Timescape™**.
- 3 Press , then tap **Settings > Set up services**.
- 4 Tap the service you want to log out of.



- ! Your account information gets deleted when you log out.

Downloading new services for Timescape™

You can perform an extension search in Android Market™ and download new services for Timescape™. Such services include applications and plug-ins that add extra features

to Timescape. For example, you can download applications that update Timescape with your activities on various social networking sites.

To download and install new services for Timescape™

- 1 From your Home screen, tap .
 - 2 Find and tap **Timescape™**.
 - 3 Press , then tap **Settings > Set up services > Extension search**.
 - 4 If you don't have a Google account set up on your phone, follow the on-screen instructions to add one. Otherwise, you are directed straight to Android Market™.
 - 5 In Android Market™, select a service to download from the list that appears, then follow the instructions to download and install it.
-  You can delete installed Timescape services the same way you delete any other installed application.



To view an event in Timescape™

- 1 From the Home screen, tap .
- 2 Find and tap **Timescape™**.
- 3 Scroll to and tap the tile for the desired event so it appears in preview mode. Then tap the tile again.

The infinite button in Timescape™



When you tap a tile, the infinite button  appears in the upper right corner. If the tile is connected to a contact, you can access related content by tapping the infinite button.

To view all communication with a contact in Timescape™



- 1 From your Home screen, tap .
- 2 Find and tap **Timescape™**.
- 3 Tap a tile for an event related to a contact.
- 4 Tap . All communication with the contact appears.
- 5 Tap or flick the filter items at the bottom of the screen to view communication with the contact through other media.

Timescape™ settings

To access Timescape™ settings

- 1 From the Home screen, tap .
- 2 Find and tap **Timescape™**.
- 3 Press , then tap **Settings**.

To schedule web service content updates in Timescape™

- 1 From your Home screen, tap .
- 2 Find and tap **Timescape™**.
- 3 Press , then tap **Settings > Update mode**.
- 4 Tap the desired option. If you select **Manual**, no automatic updates get scheduled.

Timescape™ Feed widget

The Timescape™ Feed widget shows all your most recent Timescape™ events in one view. You can flick up or down within the widget to view the full content of every event. You can also tap an event to view its content in fullscreen format or react to it using comments, likes and retweets.

Timescape™ Feed widget view

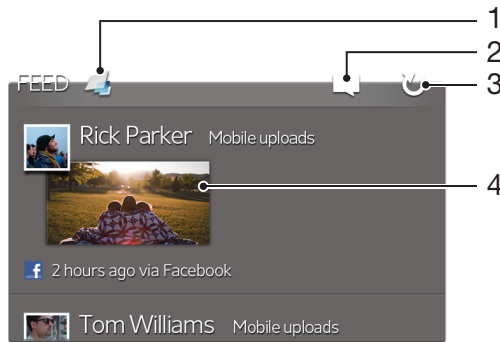

- 1 Shortcut to the Timescape™ main view
- 2 Shortcut to update status
- 3 Refresh the widget view
- 4 Most recent online event

To add the Timescape™ Feed widget to your Home screen

- 1 From your Home screen, press .
- 2 Tap **Add > Widgets**.
- 3 Tap **Timescape™ Feed**.

To remove the Timescape™ Feed widget from your Home screen

- 1 From your Home screen, touch and hold the Timescape™ Feed widget.
- 2 Drag the widget to .

Timescape™ Friends widget

The Timescape™ Friends widget notifies you of the latest social networking activities related to you and your friends. You can view all activities and communicate with your friends using comments, likes and retweets.

Timescape™ Friends widget view

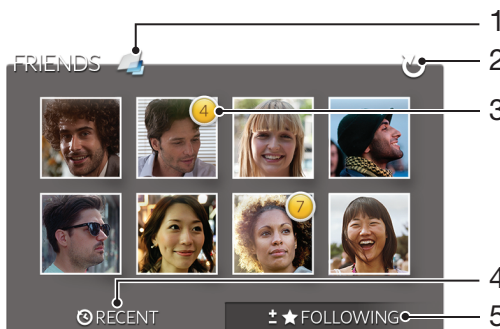

- 1 Shortcut to the Timescape™ main view
- 2 Tap to refresh the view
- 3 Activity indicator – indicates updates to feeds
- 4 Tap to show friends with most recent social networking activity
- 5 Open this tab to show the friends you are following and add other friends

To add the Timescape™ Friends widget to your Home screen

- 1 From your Home screen, press .
- 2 Tap **Add > Widgets**.
- 3 Tap **Timescape™ Friends**.

To remove the Timescape™ Friends widget from your Home screen

- 1 From your Home screen, touch and hold the Timescape™ Friends widget.
- 2 Drag the widget to .

Timescape™ Share widget

Share your status through one of the services that you have logged into from your phone. For example, you can post updates on Facebook™ or Twitter™.

Timescape™ Share widget view

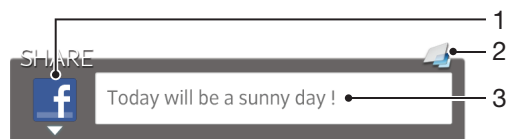

- 1 Icon showing the service currently used to send posts
- 2 Shortcut to the Timescape™ main view
- 3 Enter new posts here

To add the Timescape™ Share widget to your Home screen

- 1 From your Home screen, press .
- 2 Tap **Add > Widgets**.
- 3 Tap **Timescape™ Share**.

To remove the Timescape™ Share widget from your Home screen

- 1 From your Home screen, touch and hold the Timescape™ Share widget.
- 2 Drag the widget to .

Getting started with Android Market™

Open Android Market™ and enter a world of applications and games. You can browse these applications and games through different categories. You can also rate an application or game and send feedback on it.

To use Android Market™, you need to have a Google™ account. See *To set up a Google™ account in your phone* on page 51.

- ! Android Market™ may not be available in all countries or regions

To open Android Market™

- 1 From the Home screen, tap .
- 2 Find and tap **Market**.

Downloading from Android Market™

You can download all kinds of applications from Android Market™, including free applications.

Before you download applications

Before you start downloading from Android Market™, make sure that you have a working Internet connection.

Also, remember that you might incur data traffic charges when you download content to your phone. Contact your operator for more information.

To download a free application

- 1 In Android Market™, find an item you wish to download by browsing categories, or by using the search function.
- 2 Tap the item to view its details, and follow the instructions to complete the installation.
- 3 If the application you want to download requires access to your data or control of any functions on your phone, an additional screen appears with details. Read this screen carefully because the functionality of your phone may be seriously affected if you proceed. Tap **OK** if you agree, or **Cancel** if you wish to cancel the download.

To download a paid application

- 1 In Android Market™, find an item you wish to download by browsing categories, or by using the search function.
- 2 Tap the item to view its details, and follow the instructions in your phone to complete your purchase.
- 3 If the application you want to download requires access to your data or control of any functions on your phone, an additional screen appears with details. Read this screen carefully because the functionality of your phone may be seriously affected if you proceed. Tap **OK** if you agree, or **Cancel** if you wish to cancel the download.

To open a downloaded application

- 1 In Android Market™, press , then tap **My Apps**.
- 2 Tap the downloaded application.

- 💡 You can also access downloaded applications from the Application screen.

Clearing your application data

You may sometimes need to clear data for an application. This might happen if, for example, the application memory becomes full, or you want to clear high scores for a

game. You might also want to erase incoming email, text and multimedia messages in some applications.

To clear all cache for an application

- 1 From your Home screen, tap .
- 2 Find and tap **Settings**.
- 3 Tap **Applications > Manage applications**.
- 4 Tap the application for which you want to clear all cache.
- 5 Tap **Clear cache**.

! It is not possible to clear the cache for some applications.

To delete an installed application

- 1 From the Home screen, tap .
- 2 Find and tap **Settings**.
- 3 Tap **Applications > Manage applications**.
- 4 Tap the desired application.
- 5 Tap **Uninstall**.

! It is not possible to delete some preinstalled applications.

Permissions

Some applications need to access parts of your phone to be able to work properly. For example, a navigation application needs permissions to send and receive data traffic, and access your location. Some applications might misuse their permissions by stealing or deleting data, or reporting your location. Make sure you only install and give permissions to applications you trust.

To view permissions of an application

- 1 From the Home screen, tap .
- 2 Find and tap **Settings**.
- 3 Tap **Applications > Manage applications**.
- 4 Tap the desired application.
- 5 Scroll down to view **Permissions**.

Installing applications not from Android Market™

Installing applications of unknown or unreliable origin can damage your phone. By default, your phone is set to block such installations. However, you can change this setting and allow installations from unknown sources.

! Sony does not warrant or guarantee the performance of any third-party applications or content transferred via download or other interface to your phone. Similarly, Sony is not responsible for any damage or reduced performance of your phone attributable to the transfer of third-party content. Only use content from reliable sources. Contact the content provider if you have any questions or concerns.

To allow the installation of applications not from Android Market™

- 1 From the Home screen, tap .
- 2 Find and tap **Settings > Applications**.
- 3 Mark the **Unknown sources** checkbox.

PlayNow™ service

You can use the PlayNow™ service to download applications, music, games, ringtones and wallpapers. The PlayNow™ service offers both free and non-free downloads.



- 💡 The PlayNow™ service is not available in all countries.

Before you download content

Before you download, make sure that you have an Internet connection. Also, you may need to have enough space in the internal storage to download content.

- ! When you download content to your phone, you might be charged for the amount of data transferred. Contact your operator for information about data transfer rates in your country.

To start PlayNow™

- 1 From the Home screen, tap .
- 2 Find and tap .

Downloading from the PlayNow™ service

Download a range of content from the PlayNow™ service direct to your phone. Choose from a variety of applications, games, music, ringtones and other content. Note that payment options for non-free applications may vary per country.

To download a PlayNow item to your phone

- 1 From your Home screen, tap .
- 2 Find and tap **PlayNow™**.
- 3 Find an item you want to download by browsing categories, or by using the search function.
- 4 Tap the item to view its details.
- 5 Click “Buy now!” to start the purchase process. After your purchase has been validated, you can start to download your content.

Video Unlimited™









Use the Video Unlimited™ service to rent and purchase videos that you can view not only on your phone, but also on your PC, PlayStation® Portable (PSP®) and PlayStation® 3. Select your pick from the latest Hollywood releases, action movies, comedies, classics, and a range of other categories.

- ! Video Unlimited™ might not be available in all countries or regions.

To open Video Unlimited™

- 1 From your Home screen, tap .
- 2 Find and tap .

Video Unlimited™ menu overview

	View your account information
	Search for a video
	View the download status for all your items
	View and change settings for your account, purchases, and downloads
	Add the current video to a wish list
	Delete all items in your wish list
	Delete the video you're currently viewing from the wish list
	Share information about the current video via a social network, email, Bluetooth or other method
	View legal information

- ! The Video Unlimited™ menu is dynamic, which means that all options are not always available. For example, the option to delete all items in your wish list is only available when you are viewing the list.

To open the Video Unlimited™ menu

- Open **Video Unlimited**, then press .

Creating a Video Unlimited™ account

You need to create a Video Unlimited™ account if you want to buy or rent movies through the Video Unlimited™ service. If you already have a PlayStation® network account, then you can use that account instead.

Exploring the Video Unlimited™ selection







Browse videos by category, or enter text to search for a particular item. You can also choose to preview videos you're interested in.

Renting or buying a video

When you rent a video, you have a fixed amount of time in which to view it. This time period varies from market to market. You can also choose to download a purchased video to most Sony™ devices that are connected to your Video Unlimited™ account.

Video Unlimited™ notifications overview

When you buy or rent videos, the following notifications may appear:





-  Downloading of video is completed
-  Downloading has failed. You need to check that, for example, your phone is connected to a Wi-Fi® network, and that you have enough free space on your internal storage.
-  Downloading of video is ongoing
-  Downloading is paused
-  Confirmation of successful purchase
-  Rental countdown period has started

Watching a video from Video Unlimited™

You can watch your rented or purchased videos on most Sony™ device that are connected to your Video Unlimited™ account.

Video menu overview

When you watch a video from Video Unlimited™, you can open a menu to get the following options:

-  Delete the current video
-  View information about the current video
-  Change the audio language
-  Change the language of subtitles, or remove subtitles

Music Unlimited™

Music Unlimited™ is a subscription-based service that offers access to millions of songs over a 3G or Wi-Fi® connection. You can manage and edit your personal music library in the cloud from a variety of devices, or sync your playlists and music using a PC that runs the Windows® operating system. For more information, visit www.sonyentertainmentnetwork.com.

! Music Unlimited™ might not be available in all countries or regions.

To open Music Unlimited™

- 1 From your Home screen, tap .
- 2 Find and tap .

Getting organised



Calendar

Your phone has a calendar for managing your time schedule. If you have a Google™ account, you can also synchronise your phone calendar with your web calendar. See *Synchronising data on your phone* on page 68.



To set the calendar view



- 1 From your Home screen, tap , then find and tap **Calendar**.
- 2 Tap **Month**, **Week** or **Day** to select an option.

To view multiple calendars

- 1 From your Home screen, tap , then find and tap **Calendar**.
- 2 Press , then tap **Calendars**.
- 3 Select the calendars you want to view.

To create a calendar event



- 1 From your Home screen, tap , then tap **Calendar**.
- 2 Press , then tap **New event**.
- 3 Enter the name, time, location and description for the event.
- 4 If desired, select another option under **Repetition**.
- 5 Select a reminder for the event. To add a new reminder for the event, tap .
- 6 Tap **Save**.

-  When the appointment time approaches, your phone plays a short sound to remind you. Also,  appears in the status bar.

To view a calendar event

- 1 From your Home screen, tap , then tap **Calendar**.
- 2 Tap the event you want to view.

To change the calendar settings

- 1 From your Home screen, tap , then tap **Calendar**.
- 2 Press , then tap **Settings**.
- 3 Tap the setting you want to change, then edit as desired.

Alarm clock

Use your phone as an alarm clock and select any sound in your phone as your alarm signal. The alarm does not sound if your phone is turned off. But it does sound when your phone is set to silent mode.

To open the alarm clock

- 1 From your Home screen, tap .
- 2 Find and tap **Alarm**.

To set a new alarm

- 1 From your Home screen, tap .
- 2 Find and tap **Alarm**.
- 3 Tap **Add alarm**.
- 4 Adjust the time by scrolling up and down.
- 5 If desired, edit other alarm settings.
- 6 Tap **Done**.

To edit an existing alarm

- 1 From your Home screen, tap .
- 2 Find and tap **Alarm**.
- 3 Tap the alarm you want to edit.
- 4 Scroll up or down to adjust the time.
- 5 If desired, edit other alarm settings.
- 6 Tap **Done**.

! The alarm time format displayed is the same as the format you select for your general time settings, for example, 12-hour or 24-hour.

To deactivate an alarm

- 1 From your Home screen, tap .
- 2 Find and tap **Alarm**.
- 3 Unmark the checkbox next to the alarm you want to deactivate.

To activate an existing alarm

- 1 From your Home screen, tap .
- 2 Find and tap **Alarm**.
- 3 Tap the checkbox next to the alarm you want to activate.

To delete an alarm

- 1 From your Home screen, tap .
- 2 Find and tap **Alarm**.
- 3 Touch and hold the alarm you want to delete.
- 4 Tap **Delete alarm**, then tap **Yes**.

To set the ringtone for an alarm

- 1 From your Home screen, tap .
- 2 Find and tap **Alarm**.
- 3 Tap the alarm you want to edit.
- 4 Unmark **Style settings** checkbox.
- 5 Tap **Alarm sound** and select an option.
- 6 Tap **Done**.

To set a recurring alarm

- 1 From your Home screen, tap .
- 2 Find and tap **Alarm**.
- 3 Tap the alarm you want to edit.
- 4 Tap **Repeat**.
- 5 Mark the checkboxes for the desired days, then tap **OK**.

To set the title for an alarm

- 1 From your Home screen, tap .
- 2 Find and tap **Alarm**.
- 3 Tap the alarm you want to edit.
- 4 Tap the **Alarm text** field and enter a name for the alarm.
- 5 Tap **Done**.

To activate the vibrate function for an alarm

- 1 From your Home screen, tap .
- 2 Find and tap **Alarm**.
- 3 Tap the alarm you want to edit.
- 4 Mark the **Vibrate** checkbox.

To set alarms to sound when the phone is in silent mode

- 1 From your Home screen, tap .
- 2 Find and tap **Alarm**, then tap to select an alarm.
- 3 Mark the **Alarm in silent mode** checkbox, then tap **Done**.

To snooze an alarm when it sounds

- Tap **Snooze - min.**



To turn off an alarm when it sounds

- Slide  to the right.

Scanning with the NeoReader™ application

Use your phone as a barcode scanner to find out more about items you scan. For example, you see a coat in a magazine ad and want to find the nearest retail outlet to buy it. If the ad contains a readable barcode, the NeoReader™ application uses this code to access mobile web content, such as a web page with more product information or a map of nearby outlets. NeoReader™ supports most standard barcode types.

To start the NeoReader™ application

- 1 From the Home screen, tap .
- 2 Find and tap  NeoReader™.

To scan a barcode









- 1 When the NeoReader™ application is open, hold the phone camera over the barcode until the complete barcode is visible in the viewfinder.
- 2 The phone automatically scans the barcode, and vibrates when the barcode is recognised. If the barcode is not recognised, tap  to scan the code manually.

To enter a barcode manually

- 1 When the NeoReader™ application is open, tap .
- 2 Tap the text field, then enter the numbers of the barcode.

NeoReader™ application menu overview

The following menu options are available in the NeoReader™ application:

-  Capture the barcode using a higher image resolution in cases where NeoReader™ does not recognise the barcode automatically
-  Enter the bar code numbers manually. This option can be used if your camera has difficulty reading the bar code
-  View a list of previously scanned bar codes
-  Select preferences for how you use the NeoReader™ application
-  View information about the NeoReader™ application
-  Read more about different bar code types, and about how to use NeoReader™
-  Select your personal settings, such as language or country. This information is used to personalise bar code content
-  Send a text message to invite a friend to download the NeoReader™ application

Synchronising data on your phone

You can sync contacts, email, calendar events, and other information with your phone from multiple email accounts, synchronisation services and other kinds of accounts, depending on the applications installed on your phone. Synchronising your phone with other information sources is an easy and practical way to stay up to date.

You can:

- access your Gmail™, Google Calendar™, Google™ contacts and other Google services you use.
- access your corporate email, contacts and calendar applications.
- access your Facebook™ contacts, calendar, albums and other services you use.
- synchronise your phone with an Internet server using SyncML™.

Synchronising with Google™



Synchronise your phone with your Gmail™, Google Calendar™, Google™ contacts and data from other Google services you use. View and manage them from your phone just as easily as you would from a computer.

After synchronising, you can find Gmail™ in the Gmail™ application; Google Calendar™ in the Calendar application; Google™ contacts in the Contacts application; and other data in corresponding Google applications that you have installed.

To set up a Google™ account in your phone for synchronisation

- 1 From your Home screen, tap .
- 2 Tap **Settings > Accounts & sync**.
- 3 Make sure the **Activate auto-sync** checkbox is marked so that applications can synchronise data automatically.
- 4 Tap **Add account > Google**.
- 5 Follow the registration wizard to create a Google™ account, or sign in if you already have an account.
- 6 Mark the **Back up & restore** checkbox if you want to back up data to your Google™ account, then tap **Accept**.
- 7 Tap **Done**.
- 8 Tap your newly created Google™ account, then tap the items you want to synchronise.

To synchronise manually with your Google™ account

- 1 From the Home screen, tap .
- 2 Tap **Settings > Accounts & sync**.
- 3 Tap the Google™ account you want to synchronise.
- 4 Press , then tap **Sync now**.

To remove a Google™ account from your phone

- 1 From your Home screen, tap .
- 2 Tap **Settings > Accounts & sync**.
- 3 Tap the Google™ account you want to remove from the accounts list.
- 4 Tap **Remove account**.
- 5 Tap **Remove account** again to confirm.

- ! You can remove all your Google™ accounts from the accounts list, except for the first one. To remove the first account, you have to completely reset your phone. See *Resetting the phone* on page 137.

Synchronising your corporate email, calendar and contacts

Access your corporate email messages, calendar appointments and contacts directly from your phone. View and manage them just as easily as you would from a computer.

After setup, you can find your information in the **Email**, **Calendar** and **Contacts** applications.

- ! For you to access the functionality described above, your corporate information must be stored on a Microsoft® Exchange server.

To set up corporate email, calendar and contacts in your phone

- 1 From your Home screen, tap .
- 2 Tap **Settings** > **Accounts & sync**.
- 3 Make sure the **Activate auto-sync** checkbox is marked so that your data will synchronise automatically according to the sync interval you set.
- 4 Tap **Add account** > **Exchange Active Sync**.
- 5 Enter your corporate email address and password.
- 6 Tap **Next**.
- 7 Follow the steps to configure your account and select the kinds of data you want to sync to the phone, such as contacts and calendar. If the settings for your corporate account are not found automatically, complete the setup manually. Contact your corporate network administrator if you need more information.
- 8 When the setup is done, enter a name for this corporate account, so that it is easily identifiable, then tap **Done**.
- 9 If prompted, activate the device administrator to allow your corporate server to control certain security features in your phone. Device administrators for your phone are typically email, calendar, or other applications to which you grant authority to implement security policies on the phone when you connect to enterprise services that require this authority.

To edit the setup of corporate email, calendar and contacts

- 1 From your Home screen, tap .
- 2 Tap **Settings** > **Accounts & sync** and select your corporate account.
- 3 Tap **Account settings**.
- 4 Change the settings to suit your needs. For example, you can decide:
 - how often the phone should check for new email messages.
 - to get your corporate calendar and contacts in your phone.
 - server settings in **Incoming settings**.

To set a synchronisation interval for a corporate account

- 1 From your Home screen, tap .
- 2 Tap **Settings** > **Accounts & sync** and select your corporate account.
- 3 Tap **Account settings**.
- 4 Tap **Inbox check frequency** and select an interval option.

To remove a corporate account from your phone

- 1 From your Home screen, tap .
- 2 Tap **Settings** > **Accounts & sync**, then tap your corporate account.
- 3 Tap **Remove account**.
- 4 Tap **Remove account** again to confirm.



Synchronising with Facebook™

Set up your phone to synchronise your Facebook™ contacts, calendar entries, photos, and data from other services you use. When you set up Facebook to work in your phone, you may get the option to create a **Facebook inside Xperia™** account, which allows easier access to Facebook from other applications in your phone.

To set up a Facebook™ account on your phone

- 1 From your Home screen, tap .
- 2 Tap **Settings > Accounts & sync**.
- 3 Make sure the **Activate auto-sync** checkbox is marked so that applications can synchronise data automatically.
- 4 Tap **Add account > Facebook**.
- 5 Follow the registration wizard to create a Facebook™ account, or sign in if you already have a Facebook account.
- 6 Select a synchronisation option for your account, then tap **Finish**. The Facebook account is now set up to work on your phone.
- 7 If the Facebook icon appears in the status bar, drag down the status bar and tap **Facebook inside Xperia™** to get more information.
- 8 If you want to add a **Facebook inside Xperia™** account, mark the **Facebook integration** checkbox and then follow the on-screen instructions.

To synchronise manually with your Facebook™ account

- 1 From your Home screen, tap .
- 2 Tap **Settings > Accounts & sync**.
- 3 Tap the Facebook™ account or the **Facebook inside Xperia™** account.
- 4 Press , then tap **Sync now**.

To remove a Facebook™ account from your phone

- ! When you remove a Facebook™ account from your phone, the Facebook account is not deleted and you can still access it from a computer.

- 1 From your Home screen, tap .
- 2 Tap **Settings > Accounts & sync**.
- 3 Tap the Facebook account.
- 4 Tap **Remove account**.
- 5 Tap **Remove account** again to confirm. The Facebook account and the **Facebook inside Xperia™** account are now removed from your phone.



Synchronising using SyncML™

Synchronise your phone with an Internet server using SyncML™. View and manage contacts, calendar and bookmarks from your phone just as easily as you would from a computer.

To set up a SyncML™ account in your phone

- 1 From your Home screen, tap .
 - 2 Find and tap **Settings > Accounts & sync**.
 - 3 Make sure the **Activate auto-sync** checkbox is marked so that your data will synchronise automatically according to the interval you set.
 - 4 Tap **Add account > SyncML**.
 - 5 Tap the Name, Server address, Username and Password fields, and enter the information required.
 - 6 Tap **Sync interval** and select how often you want the phone to synchronise automatically.
 - 7 Tap a field that you want to synchronise, for example, Contacts. Then enter the information required. Repeat this step for each item you want to synchronise.
 - 8 When you're finished, tap **Done**.
- ! Contact your SyncML™ service provider for more information about your account settings.

To synchronise manually with your SyncML™ account

- 1 From your Home screen, tap .
- 2 Tap **Settings > Accounts & sync**.
- 3 Tap the SyncML™ account that you want to synchronise.
- 4 Press , then tap **Sync now**.

To set a synchronisation interval

- 1 From your Home screen, tap .
- 2 Tap **Settings** > **Accounts & sync**, then tap your SyncML™ account.
- 3 Tap **Account settings**.
- 4 Tap **Sync interval** and select an interval option.

To remove a SyncML™ account from your phone

- 1 From your Home screen, tap .
- 2 Tap **Settings** > **Accounts & sync**, then tap your SyncML™ account.
- 3 Tap **Remove account**.
- 4 Tap **Remove account** again to confirm.

NFC

NFC (Near Field Communication) is a short-range wireless technology that lets you exchange data with other devices, pay for goods using your phone, and scan special tags that give you more information about a product or service. You can share tags that you scan. You can also create your own tags and use them to send information to other NFC-compatible devices such as phones.

The tags you can create include contacts, URLs, map locations, or text. To scan or share a tag, you have to hold the NFC detection area of your phone right over the tag or next to the NFC detection area of the other device. The maximum reading distance is about one centimetre, which helps prevent unauthorised communications.

- ! NFC may not be available in all countries and/or regions.

To turn on the NFC function

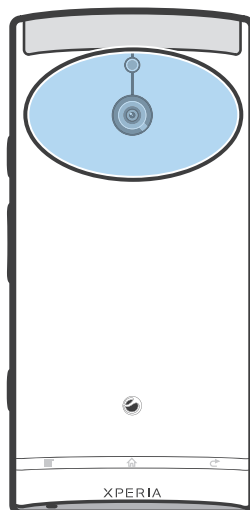

- 1 From your Home screen, tap .
- 2 Find and tap **Settings** > **Wireless & networks**.
- 3 Mark the **NFC** checkbox.

NFC detection area









- ! The location of the NFC detection area is not the same on all phones. When sharing data with another phone using NFC, refer to the User guide of the other phone for more information.

To share a contact with another phone using NFC





- 1 Make sure that both your phone and the receiving phone have the NFC function turned on and that both phone screens are active.
 - 2 To view contacts in your phone, go to your Home screen, tap , then tap .
 - 3 Tap the contact that you want to share.
 - 4 Hold your phone and the receiving phone back to back so that the NFC detection area of each phone touches the other. When the phones recognise each other, they both vibrate and the data transfer starts.
 - 5 Separate the two phones immediately after they vibrate.
 - 6 When the transfer is done, the contact information is displayed on the screen of the receiving phone and is also saved in the **Contacts** application.
- 💡 Separating the phones immediately after they vibrate prevents repeated connection attempts that could interfere with the data transfer.

To share a music file with another phone using NFC

- 1 Make sure that both your phone and the receiving phone have the NFC function turned on, the **Share my tag** checkbox under **Tags > My tag** is unchecked and that both phone screens are active.
 - 2 To open the music player, go to your Home screen, then tap **Media** > . If  is not displayed, tap , then find and tap .
 - 3 Tap the **MY MUSIC** tab to open the music library.
 - 4 Select a music category and browse to the track you want to send.
 - 5 Tap the track to play it. You can then tap  to pause the track. The transfer works whether the track is playing or paused.
 - 6 Hold your phone and the receiving phone back to back so that the NFC detection area of each phone touches the other. When the phones connect, they both vibrate and the data transfer starts.
 - 7 Separate the two phones immediately after they vibrate.
 - 8 When the transfer is done, the music file plays immediately on the receiving phone. At the same time, the file is saved in the Music application.
-  Separating the phones immediately after they vibrate prevents repeated connection attempts that could interfere with the data transfer.

-  You might not be able to copy, send or transfer copyright-protected items.

To share a photo or video with another phone using NFC

- 1 Make sure that both your phone and the receiving phone have the NFC function turned on, the **Share my tag** checkbox under **Tags > My tag** is unchecked and that both phone screens are active.
 - 2 To view photos and videos in your phone, go to your Home screen, then tap **Media** > . If  is not displayed, tap , then find and tap .
 - 3 Tap the album that contains the photo or video you want to share.
 - 4 Tap the photo or video that you want to share.
 - 5 Hold your phone and the receiving phone back to back so that the NFC detection area of each phone touches the other. When the phones recognise each other, they both vibrate and the data transfer starts.
 - 6 Separate the two phones immediately after they vibrate.
 - 7 When the transfer is done, the photo or video is displayed on the screen of the receiving phone. At the same time, it is saved in the **Gallery** application.
-  Separating the phones immediately after they vibrate prevents repeated connection attempts that could interfere with the data transfer.

Scanning NFC tags

Your phone can scan various kinds of NFC tags. For example, it can scan embedded tags on a poster, on a billboard advertisement, or beside a product in a retail store. You can receive additional information, such as a web address, or a phone number.



To scan an NFC tag

- 1 Make sure that your phone has the NFC function turned on and that the screen is active.
- 2 Place your phone over the tag so that the phone's NFC detection area touches it. Your phone scans the tag and displays the content collected. Tap the content of the tag to open it.
- 3 To open the tag, tap it.
- 4 To save the tag and return to the previous screen, tap **Done**.

Working with tags

You can use the Tags application to work with the tags you scan. For example, you can view tags and categorise the ones you like the most as favourites.

To view tags that you have scanned

- 1 From your Home screen, tap .
 - 2 Find and tap **Tags**. All tags you have scanned and saved appear under the **Tags** tab.
-  To open a tag, tap its content. For example, if the content is a URL, a webpage opens when you tap the URL.

To star a tag

- 1 Open the **Tags** application and tap a tag. The tag opens in a screen with information about the tag and a list of its contents.
 - 2 To star this tag, tap the star icon. To remove the tag from the list of starred tags, tap the star icon again.
 - 3 Tap **Done**.
-  To view all starred tags, tap the **Starred** tab.

Sharing tags

You can create tags that you can later share with others who have a phone or other device that can scan NFC tags. The tags you add can include information from one of your contacts, a URL of a web site, or text. Remember you can only share the tag that is currently selected for sharing.

To create a tag

- 1 From your Home screen, tap .
- 2 Find and tap **Tags > My tag > Add new tag**.
- 3 Select the type of tag you want to add.
- 4 Tap **Save**. The tag is added to the **Manage my tags** list and is made your current tag.

To share a tag

- 1 From your Home screen, tap .
- 2 Find and tap **Tags > My tag**.
- 3 Mark the **Share my tag** checkbox. Make sure that the NFC function is turned on and that the phone screen is active.
- 4 To stop sharing this tag, uncheck the **Share my tag** checkbox.

To change the tag currently selected for sharing

- 1 From your Home screen, tap .
- 2 Find and tap **Tags > My tag > Active tag**.
- 3 In the dialog that opens, tap the tag that you want to share. The tag is now selected for sharing.

To delete a shared tag

- 1 From your Home screen, tap .
- 2 Find and tap **Tags > My tag**.
- 3 Tap and hold a tag in the **Manage my tags** list.
- 4 In the dialog that opens, tap **Delete tag**.

Connecting to wireless networks

You can access the Internet wirelessly from your phone using Wi-Fi® technology. This way you can browse the web and access cheaper call and data rates.

If your company or organisation has a virtual private network (VPN), you can connect to this network with your phone. You can use a VPN to access intranets and other internal services at your company.

Wi-Fi®

Using Wi-Fi® technology you can access the Internet wirelessly with your phone. To access the Internet using a Wi-Fi® connection, you first need to search for and connect to an available Wi-Fi® network. The signal strength of the Wi-Fi® network may differ depending on your phone's location. Moving closer to the Wi-Fi® access point may increase the signal strength.

Before using Wi-Fi®





To browse the Internet using a Wi-Fi® connection, you need to search for and connect to an available Wi-Fi® network and then open the Internet browser. The signal strength of the Wi-Fi® network may differ depending on your phone's location. Move closer to the Wi-Fi® access point to increase the signal strength.

To turn on Wi-Fi®

- 1 From the Home screen, tap .
- 2 Find and tap **Settings** > **Wireless & networks**.
- 3 Mark the **Wi-Fi** checkbox. The phone scans for available Wi-Fi® networks.

! It may take a few seconds before Wi-Fi® is enabled.

To connect to a Wi-Fi® network

- 1 From the Home screen, tap .
- 2 Find and tap **Settings** > **Wireless & networks** > **Wi-Fi settings**.
- 3 Available Wi-Fi® networks are displayed under **Wi-Fi networks**. The available networks may be open or secured. Open networks are indicated by  and secured networks are indicated by  next to the Wi-Fi® network name.
- 4 Tap a Wi-Fi® network to connect to it. If you are trying to connect to a secure Wi-Fi® network, you are asked to enter a password.  is displayed in the status bar once you are connected.

! Your phone remembers Wi-Fi® networks you connect to. The next time you come within reach of a previously connected Wi-Fi® network, your phone automatically connects to it.

💡 In some locations, open Wi-Fi® networks require you to log in to a web page before you can get access to the network. Contact the relevant Wi-Fi® network administrator for more information.

To connect to another Wi-Fi® network

- 1 From the Home screen, tap .
- 2 Find and tap **Settings** > **Wireless & networks** > **Wi-Fi settings**. Detected Wi-Fi® networks are displayed in the **Wi-Fi networks** section.
- 3 Tap another Wi-Fi® network to connect to it.



Wi-Fi® network status

When you are connected to a Wi-Fi® network or when there are Wi-Fi® networks available in your vicinity, it is possible to see the status of these Wi-Fi® networks. You can also enable the phone to notify you whenever an open Wi-Fi® network is detected.

To enable Wi-Fi® network notifications

- 1 Turn on Wi-Fi®, if it is not already on.
- 2 From your Home screen, tap .
- 3 Find and tap **Settings** > **Wireless & networks** > **Wi-Fi settings**.
- 4 Mark the **Network notification** checkbox.

To scan for Wi-Fi® networks manually

- 1 From your Home screen, tap .
- 2 Find and tap **Settings** > **Wireless & networks** > **Wi-Fi settings**.
- 3 Press .
- 4 Tap **Scan**. The phone scans for Wi-Fi® networks and displays available networks in a list.
- 5 Tap a Wi-Fi® network in the list to connect to it.

Advanced Wi-Fi® settings

Before you add a Wi-Fi® network manually, you need to turn on the Wi-Fi® setting in your phone.

To add a Wi-Fi® network manually

- 1 From the Home screen, tap .
 - 2 Find and tap **Settings** > **Wireless & networks** > **Wi-Fi settings**.
 - 3 Tap **Add Wi-Fi network**.
 - 4 Enter the **Network SSID** for the network.
 - 5 Tap the **Security** field to select a security type.
 - 6 If required, enter a password.
 - 7 Tap **Save**.
- ! Contact your Wi-Fi® network administrator to get the **Network SSID** name and **Wireless password**.

To view detailed information about a connected Wi-Fi® network



- 1 From the Home screen, tap .
- 2 Find and tap **Settings** > **Wireless & networks** > **Wi-Fi settings**.
- 3 Tap the Wi-Fi® network that you are currently connected to. Detailed network information is displayed.

Wi-Fi® sleep policy

By adding a Wi-Fi® sleep policy, you can specify when to switch from Wi-Fi to mobile data.

- ! If you are not connected to a Wi-Fi® network, the phone uses mobile data connection to access the Internet (if you have set up and enabled a mobile data connection in your phone).





To add a Wi-Fi® sleep policy

- 1 From the Home screen, tap .
- 2 Find and tap **Settings** > **Wireless & networks** > **Wi-Fi settings**.
- 3 Press .
- 4 Tap **Advanced** .
- 5 Tap **Wi-Fi sleep policy**.
- 6 Select a **Wi-Fi sleep policy** to use.

Using a static IP address

You can set up the phone to connect to a Wi-Fi® network using a static IP address.

To set up a static IP address

- 1 From the Home screen, tap .
- 2 Find and tap **Settings > Wireless & networks > Wi-Fi settings**.
- 3 Press .
- 4 Tap **Advanced** .
- 5 Mark the **Use static IP** checkbox.
- 6 Tap and enter the information needed for your Wi-Fi® network:
 - **IP address**
 - **Gateway**
 - **Netmask**
 - **DNS 1**
 - **DNS 2**
- 7 Press  and tap **Save** .

WPS

WPS (Wi-Fi Protected Setup) is a computing standard that helps you establish secure wireless network connections. If you have little background knowledge of wireless security, WPS makes it easy for you to set up Wi-Fi Protected Access (WPA) encryption to secure your network. You can also add new devices to an existing network without entering long passwords.

Use one of these methods to enable WPS:

- Push button method – simply push a button on a WPS access point, for example, a router.
- PIN method – your phone creates a random PIN (Personal Identification Number), which you enter on the network access point device.

To connect to a Wi-Fi® network using a WPS button

- 1 From your Home screen, tap .
- 2 Find and tap **Settings > Wireless & networks**.
- 3 Mark the **Wi-Fi** checkbox.
- 4 Tap **Wi-Fi settings > Auto setup (WPS)**.
- 5 Press the WPS button on the access point within two minutes.





To connect to a Wi-Fi® network using a WPS PIN

- 1 From your Home screen, tap .
- 2 Find and tap **Settings > Wireless & networks**.
- 3 Mark the **Wi-Fi** checkbox.
- 4 Tap **Wi-Fi settings**.
- 5 Tap a network indicated by  and select **Use PIN**.
- 6 Follow the instructions that appear.



Using the Connected devices feature to share files

Share media files in your phone with other devices over a shared Wi-Fi® connection using the Connected devices feature. For example, you can use a connected client device to view photos or play music tracks that are saved on your phone. Or you can open files from the other device on your phone. A connected client device can be, for example, computer, a camera, TV, or a PlayStation®3. All devices must be DLNA Certified™ by the Digital Living Network Alliance.



To set up file sharing using the Connected devices feature

- 1 Connect your phone to a Wi-Fi® network.
 - 2 From your Home screen, tap , then find and tap **Connected Devices**.
 - 3 Press , then tap **Media server**.
 - 4 Tap  and edit your phone name, if desired. This name will later appear on other client devices connected to the Wi-Fi network, to identify your phone.
 - 5 Mark the **Share content** checkbox.  appears in the status bar. Your phone can now work as a media server.
 - 6 Connect your computer or other device(s) to the same Wi-Fi® network as your phone.
 - 7 A notification appears in the status bar of the phone. Tap it and set access permissions.
 - 8 To close the **Connected Devices** view, press . The Media server function stays running in the background.
 - 9 To turn off the media server, go to the **Connected Devices** view in the phone and unmark the **Share content** checkbox.
- ! The instructions described above may differ depending on the client devices. Also refer to your client device User guide. If the device cannot connect, check that your local network is working.



To set access permissions for a pending device

- 1 From your Home screen, tap , then find and tap **Connected Devices**.
- 2 Press , then tap **Media server**.
- 3 Select a device from the **Pending devices** list.
- 4 Select an access permission level.

To change the name of a registered device

- 1 From your Home screen, tap , then find and tap **Connected Devices**.
- 2 Press , then tap **Media server**.
- 3 Select a device from the **Registered devices** list, then select **Change name**.
- 4 Enter a new name for the device.

To change the access level of a registered device

- 1 From your Home screen, tap , then find and tap **Connected Devices**.
- 2 Press , then tap **Media server**.
- 3 Select a device from the **Registered devices** list.
- 4 Tap **Change access level** and select an option.

To get help about sharing content with other devices

- When the **Connected Devices** view is open, press , then tap **Help**.

Playing files from other devices on your phone

Once you have set up the Connected devices feature, you can start playing media files from other devices on your phone.



To play a shared media file on your phone

- 1 Make sure the devices that you want to share files with are connected to the same Wi-Fi® network as your phone.
- 2 From your Home screen, tap , then find and tap **Connected devices**.
- 3 Select a connected device under **Server list**.
- 4 Browse the folders of the connected device and select the media file that you want to open. The file starts playing automatically.



Playing shared media files on other devices

You can use the Connected devices feature to access photos and videos saved to the internal storage of your phone from other devices.

To view photos or videos from your phone on another device

- 1 Make sure the devices that you want to share files with are connected to the same Wi-Fi® network as your phone.
- 2 From your Home screen, tap .
- 3 Find and tap **Gallery**.
- 4 Open the album containing the files that you want to view.
- 5 Touch and hold any photo or video. Checkboxes appear for each item.
- 6 Mark the item or items that you want to view, then press , and then tap .
- 7 Select a device. The selected files start playing in chronological order on the device that you select.

To play a music track from your phone on another device

- 1 Make sure the devices that you want to share files with are connected to the same Wi-Fi® network as your phone.
- 2 From your Home screen, tap , then find and tap .
- 3 Tap **MY MUSIC** to open the music library.
- 4 Select a music category and browse to the track that you want to play.
- 5 Tap .
- 6 Select a device. The track plays automatically on the device that you select.

- 💡 You can also play a track from your phone on another device by tapping the cover art for the track and then tapping **Play on device**.

Sharing your phone's mobile data connection

You can share your phone's mobile data connection with a single computer using a USB cable. This process is called USB tethering. You can also share your phone's data connection with up to eight devices at once, by turning your phone into a portable Wi-Fi® hotspot.

When your phone is sharing its data connection, the following icons may appear in the status bar or in the Notification panel:



USB tethering is active



Portable Wi-Fi® hotspot is active



Both USB tethering and portable hotspot are active

To share your phone's data connection using a USB cable

- 1 Deactivate all USB cable connections to your phone.
- 2 Using the USB cable that came with your phone, connect your phone to a computer.
- 3 From your Home screen, tap .
- 4 Find and tap **Settings** > **Wireless & networks** > **Tethering**.
- 5 Mark the **USB tethering** checkbox. The phone starts sharing its mobile network data connection with the computer over the USB connection. An ongoing notification appears in the status bar and the Notification panel.
- 6 Unmark the **USB tethering** checkbox, or disconnect the USB cable to stop sharing your data connection.

- ! You cannot share your phone's data connection and internal storage over a USB cable at the same time. For more information, see *Connecting your phone to a computer* on page 119.

- 💡 You may need to prepare your computer to establish a network connection via USB cable. Go to android.com/tether to get the most current information.

To share your phone's data connection as a portable Wi-Fi® hotspot

- 1 From the Home screen, tap .
- 2 Find and tap **Settings > Wireless & networks > Tethering.**
- 3 Tap **Portable Wi-Fi hotspot settings > Configure Wi-Fi hotspot.**
- 4 Enter the **Network SSID** for the network. Tap the **Security** field to select a security type.
- 5 If required, enter a password.
- 6 Tap **Save.**
- 7 Mark the **Portable Wi-Fi hotspot** checkbox. The phone starts broadcasting its Wi-Fi® network name (SSID). You can now connect to this network with up to 8 computers or other devices.
- 8 Unmark the **Portable Wi-Fi hotspot** checkbox when you want to stop sharing your data connection via Wi-Fi®.

To rename or secure your portable hotspot



- 1 From the Home screen, tap .
- 2 Find and tap **Settings > Wireless & networks > Tethering.**
- 3 Make sure the **Portable Wi-Fi hotspot** checkbox is marked.
- 4 Tap **Portable Wi-Fi hotspot settings > Configure Wi-Fi hotspot.**
- 5 Enter the **Network SSID** for the network.
- 6 Tap the **Security** field to select a security type.
- 7 If required, enter a password.
- 8 Tap **Save.**

Virtual private networks (VPNs)

Use your phone to connect to virtual private networks (VPNs), which allow you to access resources inside a secured local network from outside the actual network. For example, VPN connections are commonly used by corporations and educational institutions for users who need to access intranets and other internal services when they are outside of the internal network, for example, when they are travelling.

VPN connections can be set up in many ways, depending on the network. Some networks may require you to transfer and install a security certificate in your phone. See *Connecting your phone to a computer* on page 119 for more information on how to transfer content to your phone. For detailed information on how to set up a connection to your virtual private network, please contact the network administrator of your company or organisation.

To add a virtual private network

- 1 From the Home screen, tap .
- 2 Find and tap **Settings > Wireless & networks > VPN settings.**
- 3 Tap **Add VPN.**
- 4 Select the type of VPN to add.
- 5 Enter your VPN settings.
- 6 Press  and tap **Save.**

To connect to a virtual private network

- 1 From the Home screen, tap .
- 2 Find and tap **Settings > Wireless & networks > VPN settings.**
- 3 In the list of available networks, tap the VPN you want to connect to.
- 4 Enter the required information.
- 5 Tap **Connect.**

To disconnect from a virtual private network

- 1 Drag the status bar downwards.
- 2 Tap the notification for the VPN connection to turn it off.

Web browser







Use your web browser to view and navigate web pages, add pages as bookmarks, and create shortcuts to your Home screen. You can open several browser windows at the same time and use the zoom function when navigating a web page.

To open the web browser

- 1 From your Home screen, tap .
- 2 Find and tap .

Toolbar

The toolbar options make browsing easy:

-  Open a new browser window
-  Add, open or edit a bookmark. View your most visited web pages or open web pages from the browser history
-  View open windows
-  Refresh the current web page
-  Go forward one page in the browsing history
-  Open a menu to see more options

To open the toolbar

- From the browser, press .

Browsing the web

Search and address bar

Use the search and address bar to browse the web.

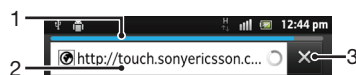

- 1 View the download progress of the current web page
- 2 Enter a search word to search for a web page, or enter a web page address to load a web page
- 3 Cancel the download of the current web page

- 💡 When a page has finished downloading, tap the bookmark icon  next to the search and address bar to bookmark it.

To open a web page

- 1 In your browser, tap the text field in the search and address bar to activate the keypad.
- 2 Enter a web address.
- 3 If you are using portrait view, tap . If you are using landscape mode, tap **Go**.

To search for a web page

- 1 Tap the search and address text field to activate the keypad.
- 2 Enter a search word or phrase.
- 3 If you are using portrait view, tap . If you are using landscape mode, tap **Go**.

To exit the web browser

- While browsing, press .
- 💡 When you open the browser again, the browser appears exactly as it did before you exited, that is, with the same number of windows, position and zoom levels.

Navigating web pages

To select a link



- To select a link in a web page, tap the link. The selected link is highlighted in orange, and the web page is loaded when you release your finger.
- 💡 If you select a link by mistake before releasing your finger, you can deselect it by dragging your finger away until the link is no longer highlighted.

To go to the previous page while browsing

- Press .

To zoom in or out on a web page

Use one of the following methods to zoom in or out on a web page:

- Touch an area of the page with two fingers at once and spread them apart to zoom in, or pinch them together to zoom out.
- Slide your finger on the screen to make the zoom controls appear. Tap the  icon to zoom in, or tap  to zoom out.
- Double-tap to zoom in on the web page, or double-tap again to zoom out.

To reload the current web page

- Press , then tap **Refresh**.

To add a web page shortcut to your Home screen

- 1 When viewing a web page, press .
- 2 Tap **Bookmarks > Add**.
- 3 If desired, you can edit the name and the web address. When you're done, tap **OK**.
- 4 Tap and hold the bookmark to open a menu.
- 5 Tap **Add shortcut to Home**.



To share a link to the current web page

- 1 While browsing, press .
- 2 Tap **More > Share page**.
- 3 Select an available transfer method, and follow the on-screen instructions.

Managing bookmarks

Bookmarks let you access your favourite and frequently visited web pages quickly. Depending on your network operator, some bookmarks may be pre-installed on your phone.

To bookmark a web page

- 1 While you are viewing a web page, press .
 - 2 Tap **Bookmarks > Add**.
 - 3 If desired, you can edit the name and the web address.
 - 4 When you're done, tap **OK**.
- 💡 To bookmark a web page, you can also tap the  icon to the right of the search and address field.

To open a bookmark

- 1 When the Browser is open, press .
- 2 Tap **Bookmarks**.
- 3 Tap the bookmark you want to open.



To edit a bookmark

- 1 When the Browser is open, press .
- 2 Tap **Bookmarks**.
- 3 Touch and hold a bookmark to open a menu.
- 4 Tap **Edit bookmark**.
- 5 Edit the name and the web address, as desired.
- 6 When you're done, tap **OK**.

To delete a bookmark



- 1 When the Browser is open, press .
- 2 Tap **Bookmarks**.
- 3 Touch and hold a bookmark to open a menu.
- 4 Tap **Delete bookmark** to delete the selected bookmark.

To bookmark a previously visited web page

- 1 When the Browser is open, press .
- 2 Tap **Bookmarks**.
- 3 Tap the **History** tab, or the **Most visited** tab, to view a list of previously visited web pages.
- 4 Tap the  icon to the right of the web page you want to add as a bookmark.

Managing text and images

To find text within a web page

- 1 When you are viewing a web page, press .
- 2 Tap **More > Find on page**.
- 3 Enter your search text. Matching characters appear highlighted in green.
- 4 Tap the left or right arrow to go to the previous or next matching item.
- 5 Tap  to close the search bar.

To copy text from a web page

- 1 Locate the text you want to copy.
- 2 Press .
- 3 Tap **More > Select text**.
- 4 Place your finger at the start of the text you want to select and then drag it to the desired end point. The text you select becomes highlighted.
- 5 Tap the selected text to copy it.
- 6 To paste text into an email, text message or multimedia message, touch and hold the text field in the relevant application and tap **Paste** in the menu that appears.

To save an image from a web page

- 1 On the active web page, touch and hold the desired image until a menu appears.
- 2 Tap **Save image**.

Multiple windows

Your browser can run in up to eight different windows at the same time. You can, for example, log in to your webmail in one window and read today's news in another. You can easily switch from one window to another.

To open a new browser window

- 1 When the Browser is open, press .
- 2 Tap **New window**.

To open a link in a new browser window

- 1 Touch and hold a link until a menu appears.
- 2 Tap **Open in new window**.

To switch between browser windows

- 1 When the Browser is open, press .
- 2 Tap **Windows** to see a list of all open windows.
- 3 Tap the window you want to switch to.

Downloading from the web

You can download applications and content when you browse the web using the web browser in your phone. Usually you have to touch a download link for the desired file and the download then starts automatically.

To view your downloaded files

- 1 When the Browser is open, press .
- 2 Tap **More > Downloads**.

To cancel an ongoing download

- 1 When the Browser is open, press .
- 2 Tap **More > Downloads**.
- 3 Mark the checkbox beside the downloading file you want to delete.
- 4 Tap **Cancel**.

Browser settings

You can change the browser settings and customise your browser view. For example, you can change the size of the text displayed to suit your needs, or you can clear cache, cookies, browser history, and other data linked to the websites you visit.

To change your browser settings

- 1 When the Browser is open, press .
- 2 Tap **More > Settings**.

To change the text size on web pages

- 1 When the browser is open, press .
- 2 Tap **More > Settings > Text size**.
- 3 Select a text size.

To clear the cache memory from your phone

- 1 When the browser is open, press .
- 2 Tap **More > Settings**.
- 3 Find and tap **Clear cache**, then tap **OK** to confirm.

To clear your browser cookies

- 1 When the browser is open, press .
- 2 Tap **More > Settings**.
- 3 Find and tap **Clear all cookie data**, then tap **OK** to confirm.

To clear your browser history

- 1 When the browser is open, press .
- 2 Tap **More > Settings**.
- 3 Find and tap **Clear history**, then tap **OK** to confirm.

Auto-fitting web pages

The auto-fit option makes it easier for you to read large websites with text and images, such as news sites. For example, if you zoom in on a web page when auto-fit is enabled,

the text automatically adjusts to the new screen size. If auto-fit is disabled, you might need to scroll sideways to read a full sentence.



To auto-fit web pages

- 1 When the Browser is open, press .
- 2 Tap **More > Settings > Auto-fit pages**.

Plug-in settings

You can adjust how a plug-in functions on a web page. For example, you can enable plug-ins to get optimal visual effect when you view a web page. Alternatively, to increase browsing speed, you can configure your browser to only run plug-ins on demand, or you can disable plug-ins completely.

To enable plug-ins on demand

- 1 When the browser is open, press .
 - 2 Tap **More > Settings**.
 - 3 Find and tap **Enable plug-ins**.
 - 4 Mark the **On demand** checkbox.
-  You may need to restart your browser for the setting to take effect.

Music

Get the most out of your music player. Listen to and organise music, audio books and podcasts that you have transferred to your phone's internal storage from a computer, or purchased and downloaded from online stores.

To make content easily available to the music player, you can use the Media Go™ application. Media Go™ helps transfer music content between a computer and a phone. For more information, see *Connecting your phone to a computer* on page 119.

Protecting your hearing

Listening to the music player or other media players for a prolonged period of time can damage your hearing, even when the volume is at a moderate level. To alert you to such risks, a volume level warning appears when the volume is too high, and after the music player is used for over 20 hours.

To turn off the volume level warning

- When  appears, tap **OK** to dismiss the warning.
- 💡 Every time you restart your phone, the media volume is automatically set to a safe level.





Copying media files to your phone's internal storage

Copy all your favourite media content from computer to phone and start using your phone's entertainment features to the full. It's easy to transfer music, photos, videos and other files. Just connect your phone to a computer with a USB cable and use either the computer's file manager application or the Media Go™ application to transfer your files.

See *Connecting your phone to a computer* on page 119 for more general information about connecting your phone to a computer and transferring files.

Using the music player

To play audio content

- 1 From your Home screen screen, tap **Media** >  to open the music player. If  is not displayed, tap , then find and tap .
- 2 Tap **MY MUSIC** to open the music library.
- 3 Select a music category and browse to the track that you want to open.
- 4 Tap a track to play it.

Music player overview

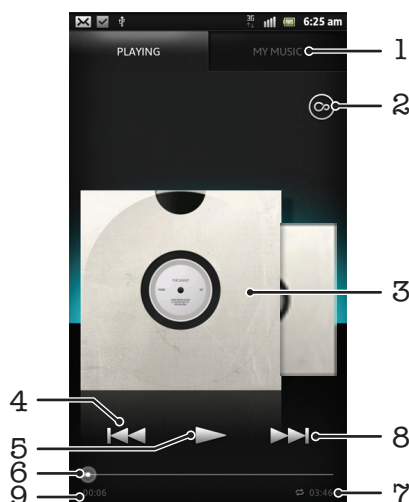

- 1 Browse the music on your phone's internal storage
- 2 Tap the infinite button to find related information online and plug-ins from Android Market™
- 3 Album art (if available)
- 4 Go to the previous track in the current play queue, or rewind
- 5 Play/Pause button
- 6 Progress indicator – drag the indicator or tap along the line to fast forward or rewind
- 7 Total time length of the track
- 8 Go to the next track in the current play queue, or fast forward
- 9 Elapsed time of current track



To change tracks

- When a track is playing, tap  or .
- When a track is playing, swipe the album art left or right.

To pause a track

- In the music player, tap .



To fast forward and rewind music

- In the music player, touch and hold  or .
- 💡 You can also drag the progress indicator marker right or left.

To adjust the audio volume

- When the music player is playing a track, press the volume key.

To improve the sound quality using the equalizer

- 1 When the music player is open, press .
- 2 Tap **Equalizer**. If you want to adjust the sound manually, drag the frequency band buttons up or down.
- 3 If you prefer to adjust the sound automatically, tap  and select a style.

To turn on the Surround sound

- 1 When the music player is open, press .
- 2 Tap **Equalizer** > **More** > **Headphone surround**.
- 3 Select a setting.
- 4 Tap **OK**.



To view the current play queue

- While a track is playing in the music player, tap the album art and then tap .

To minimise the music player

- When the music player is playing, press  to go to the previous screen, or press  to go to the Home screen. The music player stays playing in the background.

To return to the music player when it is playing in the background

- 1 Drag the status bar downwards to open the Notification panel.
 - 2 Tap the track title to open the music player.
- 💡 Alternatively, you can press and hold  and then tap  to return to the music player.

To delete a track

- 1 Open the music player library and browse to the track you want to delete.
- 2 Touch and hold the track title, then tap **Delete**.

- 💡 You can also delete albums this way.

To share a track

- 1 When browsing your tracks in the music player library, touch and hold a track title.
- 2 Tap **Send**.
- 3 Select an available transfer method, and follow the on-screen instructions.

💡 You can also share albums and playlists this way.

⚠️ You might not be able to copy, send or transfer copyright-protected items.

To recommend a track on Facebook™

- 1 While the track is playing in the music player, tap  to show that you "Like" it on **Facebook™**. If desired, add a comment in the comments field.
- 2 Tap **Share** to send the track to **Facebook™**. If the track is received successfully, you will get a confirmation message from **Facebook™**.

Searching for related content with the infinite button

When a track is playing in the music player, you can use the infinite button to instantly search for audio content that is related to the artist or track.

The infinite button launches a search for the following:

- music and karaoke videos on YouTube™
- artist info on Wikipedia™
- lyrics on Google.com

To search for related content using the infinite button

- When a track is playing in the music player, tap .

Overview of My music

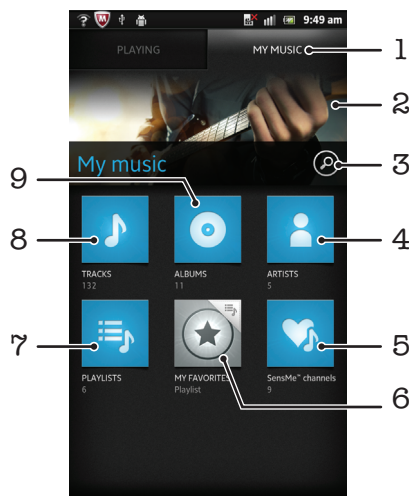

1 Browse the music on your phone's internal storage

2 Picture of the currently playing artist (if available)

3 Search all tracks saved on your phone

4 Browse your music by artist

5 Categorise your music using SensMe™ channels

6 Browse your favorite playlists

7 Browse all playlists



8 Browse audio by track

9 Browse by album

Using My music to organise your tracks

Tap the My Music tab in the Music player to get an overview of all the tracks you've saved to your phone's internal storage. In My Music you can manage your albums and playlists, create shortcuts, and arrange music by mood and tempo.

To add a music track as a shortcut

- 1 In the music player, tap **MY MUSIC**.
- 2 Tap , , or , and browse to the track that you want to save as a shortcut.
- 3 Touch and hold the track title.
- 4 Tap **Add as shortcut**. The shortcut now appears in the My music main view.

To rearrange shortcuts



- 1 In the music player, tap **MY MUSIC**.
- 2 Touch and hold a shortcut until it magnifies and the phone vibrates, then drag the item to a new location.

To delete a shortcut

- 1 In the music player, tap **MY MUSIC**.
- 2 Touch and hold a shortcut until it magnifies and the phone vibrates, then drag the item to .

! You can't delete the following tabs: **Tracks**, **Albums**, **Artists**, **Playlists** and **SensMe™ channels**.

To update your music with the latest information



- 1 In My music, press .
- 2 Tap . Your phone searches online and downloads the latest available album art and track information for your music.

💡 Downloading music information also enables SensMe™ channels.

Categorising your music using SensMe™ channels

The SensMe™ channels application helps you arrange your music by mood and tempo. SensMe™ groups all your tracks into twelve categories, or channels, so you can select music that matches your mood or suits the time of day.

To enable the SensMe™ channels application



- 1 In the music player, tap **MY MUSIC**.
- 2 Tap  > .

! This application requires a mobile or Wi-Fi® network connection.

Playing music in random order

You can play tracks in playlists in random order. A playlist can be, for example, a playlist you have created yourself or an album.

To play tracks in random order

- 1 In the music player, tap **MY MUSIC**.
- 2 Tap  or  and browse to an album or playlist.
- 3 Tap the album or playlist, to open it.
- 4 Tap .

💡 When an album or playlist is open, you can also tap  and choose shuffle mode or repeat mode.

Playlists

The music player automatically creates Smart playlists on the playlist tab  in the music player library. You can also create your own playlists from the music that is saved on your phone's internal storage.

In addition, you can install the Media Go™ application on a computer and use it to copy playlists from the computer to your phone's internal storage. For more information, see *Connecting your phone to a computer* on page 119.

To create your own playlists

- 1 In the music player, tap **MY MUSIC**.
- 2 To add an artist, album or a track to a playlist, touch and hold the name of the artist or the title of the album or track.
- 3 In the menu that opens, tap **Add to playlist > Create new playlist**.
- 4 Enter a name for the playlist and tap **OK**.

To add tracks to a playlist

- 1 When browsing the music player library, touch and hold the name of the artist or the title of the album or track you want to add.
- 2 Tap **Add to playlist**.
- 3 Tap the name of the playlist to which you want to add the artist, album or track. The artist, album or track is added to the playlist.

To play your own playlists

- 1 In the music player, tap **MY MUSIC**.
- 2 Tap .
- 3 Under **Playlists**, tap a playlist.
- 4 Tap a track to play it.

To remove a track from a playlist

- 1 In a playlist, touch and hold the title of the track you want to delete.
- 2 Tap **Delete from playlist**.

To delete a playlist

- 1 In the music player, tap **MY MUSIC**, then select **Playlists**.
- 2 Touch and hold the playlist you want to delete.
- 3 Tap **Delete**.
- 4 Tap **Delete** again to confirm.

Music player widget

The music player widget is a miniature application that gives you direct access to the music player from your Home screen. You need to add this widget to your Home screen before you can use it.

To add the music player widget to your Home screen



- 1 From your Home screen, press .
- 2 Tap **Add > Widgets**.
- 3 Tap .

Identifying music using TrackID technology



Use the TrackID™ music recognition service to identify a music track you hear playing in your surroundings. Just record a short sample of the song and you'll get artist, title and album info within seconds. You can purchase tracks identified by TrackID™ and you can view TrackID charts to see what TrackID users around the globe are searching for. For best results, use TrackID™ technology in a quiet area. If you have problems using this application, see *I cannot use Internet-based services* on page 138.

- ! The TrackID™ application and the TrackID™ service are not supported in all countries/regions, or by all networks and/or service providers in all areas.

To open the TrackID™ application

- 1 From your Home screen, tap .
 - 2 Find and tap **TrackID™** .
- 💡 You can also use the TrackID™ widget to open the TrackID™ application.



To search for track information using TrackID™

- 1 When the **TrackID™** application is open, hold the phone towards the music source.
 - 2 Tap . If the track is recognised by the TrackID™ service, the results appear on the screen.
- 💡 To return to the TrackID™ start screen, press .

To view your TrackID™ search history

- When the **TrackID™** application is open, tap .

To view TrackID™ charts

- 1 When the **TrackID™** application is open, tap the  tab. The first time you view a chart, it is set to your own region.
- 2 To see charts of the most popular searches in other regions, tap  > **Regions**.
- 3 Select a country or region.

Using TrackID™ technology results

Track information appears when the TrackID™ application recognises a track. You can choose to purchase the track, recommend it on Facebook™, or share it using email, Bluetooth or SMS. You can also get more information about the track's artist, or search for related track content on YouTube™.

To buy a track using TrackID™ technology

- 1 When the **TrackID™** application is open, tap a track title.
 - 2 In the track information screen, tap **Download**.
 - 3 Follow the instructions in your phone to complete your purchase.
- ! The track purchase feature may not be supported in all countries/regions, or by all networks and/or service providers in all areas.

To recommend a track on Facebook™

- 1 When the **TrackID™** application is open, tap a track title.
 - 2 In the track information screen, wait for the  tab to appear, then tap this tab.
 - 3 Log in to **Facebook** and recommend the track.
- ! The feature may not be supported in all countries/regions, or by all networks and/or service providers in all areas.

To share a track using TrackID™ technology



- 1 When the **TrackID™** application is open, tap a track title.
- 2 In the track information screen, tap **Share**.
- 3 Select one of the available transfer methods.

! The track share feature may not be supported in all countries/regions, or by all networks and/or service providers in all areas.

Using TrackID™ to identify tracks on the FM Radio

You can use **TrackID™** technology to identify music tracks as they play on your phone's FM radio and share them on **Facebook**.

To identify a track on the FM radio using TrackID™

- 1 Connect a headset or a set of headphones to your phone.
- 2 From your Home screen, tap .
- 3 To open the radio, find and tap **FM radio** . The available channels appear as you scroll through the frequency band.
- 4 While a song is playing on the FM radio, tap .
- 5 The TrackID™ application samples the song. If the track is recognised, you are presented with a track result, or a list of possible tracks.

! This feature is not supported in all countries/regions, or by all networks and/or service providers in all areas.

To share a radio track on Facebook™



- 1 Make sure that Facebook integration is enabled.
- 2 Log in to Facebook™.
- 3 Open the FM radio.
- 4 When the FM radio plays a song that you want to share, use the TrackID™ application to recognise the song.
- 5 When you are presented with a track result, tap  to send details of the track to Facebook™. If desired, you can also enter a comment in the Facebook™ comment field.

Using the FM radio

The FM radio in your phone works like any FM radio. For example, you can browse and listen to FM radio stations and save them as favourites. You must connect a wired headset or headphones to the phone before you can use the radio. This is because the headset or headphones act as an antenna. After one of these devices is connected, you can then switch the radio sound to the phone speaker, if desired.

- 💡 When you open the FM radio, available channels appear automatically. If a channel has RDS information, it appears a few seconds after you start listening to the channel.

To start the FM radio

- 1 Connect a headset or a set of headphones to your phone.
- 2 From your Home screen, tap .
- 3 Find and tap **FM radio** . The available channels appear as you scroll through the frequency band.

- ! When you start the FM radio, available channels appear automatically. If a channel has RDS information, it appears a few seconds after you start listening to the channel.

FM radio overview

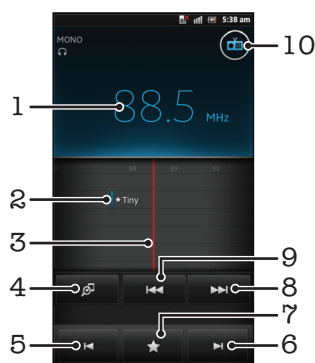

- 1 Tuned frequency
- 2 A saved favourite channel
- 3 Tuning dial
- 4 Launch the TrackID™ music recognition application
- 5 Move down the frequency band to the next favourite channel
- 6 Move up the frequency band to the next favourite channel
- 7 Save or remove a channel as a favourite
- 8 Move up the frequency band to search for a channel
- 9 Move down the frequency band to search for a channel
- 10 Radio on/off button



To move between radio channels

- Flick your finger left or right along the frequency band.
- Drag the tuning dial right or left.



Using your favourite radio channels

You can save the radio channels you most frequently listen to as favourites. By using favourites you can quickly return to a radio channel.

To save a channel as a favourite

- 1 When the radio is open, navigate to the channel that you want to save as a favourite.
- 2 Tap , then select .
- 3 Enter a name for the channel, then press **Save**.

To remove a channel as a favourite

- 1 When the radio is open, tap .
- 2 Tap  next to the channel that you want to remove.
- 3 Tap **Delete**.

To move between favourite channels

- When the radio is open, tap  or .
- ! To move between favourites, you must first save at least two channels as favourites.

Making a new search for radio channels

If you have moved to a new location or the reception has improved in your current location, you can start a new scan for radio channels.

- ! Any favourites you have saved are not affected by a new scan.



To start a new search for radio channels

- 1 When the radio is open, press .
- 2 Tap **Search for channels**. The radio scans the whole frequency band, and all available channels are displayed.

Switching the radio sound between devices

You can listen to the radio through a wired headset or through wired headphones. Once either device is connected, you can switch the sound to the phone speaker, if desired.



To switch the radio sound to the phone speaker

- 1 When the radio is open, press .
 - 2 Tap **Play in speaker**.
- 💡 To switch the sound back to the wired headset or headphones, press  and tap **Play in headphones**.

Switching between mono and stereo sound mode

You can listen to your FM radio in either mono or stereo mode. In some situations, switching to mono mode can reduce noise and improve sound quality.



To switch between mono and stereo sound mode

- 1 When the radio is open, press .
- 2 Tap **Enable stereo sound**.
- 3 To listen to the radio in mono sound mode again, press  and tap **Force mono sound**.

Identifying radio tracks using TrackID™

Use **TrackID™** technology to identify music tracks as they play on your phone's FM radio.



To identify a song on the FM radio using TrackID™

- 1 While the song is playing on your phone's FM radio, tap .
 - 2 A progress indicator appears while the TrackID™ application samples the song. If successful, you are presented with a track result, or a list of possible tracks.
 - 3 Press  to return the FM Radio.
- ! The TrackID™ application and the TrackID™ service are not supported in all countries/regions, or by all networks and/or service providers in all areas.

Sharing the details of music you like on Facebook™

When you listen to music using the FM Radio, you can share details of tracks you like on **Facebook**. You need to be a **Facebook** user and must be logged in to **Facebook**.

To share details of music you like on Facebook™

- 1 When the FM radio is playing a music track that you want to share, find and tap .
 - 2 Add a comment in the comment field, if desired.
 - 3 Tap **Share** to send details of the track to **Facebook**.
 - 4 Tap **Cancel** to return to the **FM radio** application.
 - 5 Once you have posted a track to your **Facebook** account, a confirmation message appears on the FM radio screen.
- !  will not appear on the FM radio screen if you are not logged in to **Facebook**.

Taking photos and recording videos

Your phone camera is equipped with the highly sensitive Exmor R™ sensor, which helps you capture sharp photos and videos even in low lighting conditions. With your phone camera, you can take regular 2D photos or you can shoot 3D photos in 3D Sweep Panorama mode and Sweep Multi Angle mode. Send your photos and videos to friends as multimedia messages, or upload them to a web service. Your phone also has a front camera, which is useful for self-portraits.

Camera controls overview

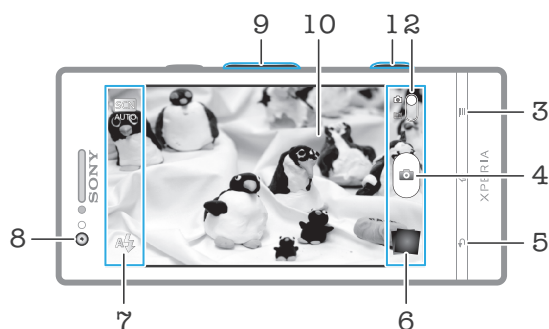

- 1 Camera key – Activate the camera/Take photos/Record videos
- 2 Switch between still and video camera
- 3 Display all settings
- 4 Take photos or record video clips
- 5 Go back a step or exit the camera
- 6 View photos and videos
- 7 Camera setting icons
- 8 Front camera
- 9 Zoom in or out
- 10 Main camera screen

To activate the camera

- Press and hold down the camera key.



To close the camera

- Press  from the main camera screen.

Using the still camera





There are three ways to take photos with the still camera. You can press the camera key, tap the on-screen camera button, or touch a spot on the screen.

To take a photo by touching the screen



- 1 Activate the camera.
- 2 If the still camera is not selected, drag  to .
- 3 To display all settings, press .
- 4 Tap **Capturing method** and select **Touch capture** if it is not already selected.
- 5 Point the camera towards the subject.
- 6 To activate auto focus, touch and hold a spot on the screen. When the focus frame turns green, lift your finger to take the photo.

- ! Be careful not to touch ,  or other icons when touching the screen to take a photo.

To take a photo by tapping the on-screen button

- 1 Activate the camera.
- 2 If the still camera is not selected, drag  to .
- 3 To display all settings, press .
- 4 Tap **Capturing method** and select **On-screen button** if it is not already selected.
- 5 Point the camera towards the subject.
- 6 Tap the on-screen button . The photo is taken as soon as you release your finger.

To take a self-portrait using the front camera

- 1 Activate the camera.
- 2 If the still camera is not selected, drag  to .
- 3 Tap the icon on the top left of the screen, then select **Front camera**.
- 4 To display all settings, press .
- 5 To take the photo, press the camera key. The photo is taken as soon as you release your finger.

To use the zoom function

- When the camera is open, press the volume key up or down to zoom in or out.



To use the still camera flash

- 1 When the camera is open, press .
- 2 Tap **Flash**, and select your desired flash setting.
- 3 Take the photo.

To view your photos and videos

- 1 Open the camera, then tap a thumbnail at the bottom of the screen to open a photo or video.
 - 2 Flick left or right to view your photos and videos. Videos are identified by .
- 💡 In step 1, you can also flick the thumbnails from right to left and then select the one you want to view.



To delete a photo

- 1 Open the photo you want to delete.
 - 2 Press , and then tap .
- 💡 To delete a recently taken photo or video, you can also flick the thumbnail at the bottom right of the viewfinder and then press and hold the item you want to delete.

Face detection

You can use face detection to bring an off-centre face into focus. The camera automatically detects up to five faces, indicated by white frames. A yellow frame shows which face has been selected for focus. Focus is set to the face closest to the camera. You can also tap one of the frames to select which face should be in focus.

To turn on face detection

- 1 Activate the camera.
- 2 If the still camera is not selected, drag  to .
- 3 Tap the icon on the top left, then select **Normal**.
- 4 To display all settings, press .
- 5 Tap **Focus mode** > **Face detection**.



To take a photo using face detection

- 1 When the camera is open and **Face detection** is set, point the camera at your subject. Up to five faces can be detected, and each detected face is framed.
- 2 Tap the frame you want to select for focus. Do not tap if you want the camera to select focus automatically.
- 3 Press the camera key halfway down. A green frame shows which face is in focus.
- 4 To take the photo, press the camera key fully down.

Smile detection

Smile detection allows you to capture a face just as it smiles. The camera detects up to five faces and selects one face for smile detection and auto focus. A green frame shows which face is selected. When the selected face smiles, the camera automatically takes a photo.

To turn on smile detection



- 1 Activate the camera.
- 2 If the still camera is not selected, drag  to .
- 3 To display all settings, press .
- 4 Tap **Smile detection** and select a smile level.

To take a photo using smile detection





- 1 When the camera is open and **Smile detection** is turned on, point the camera at your subject. Each detected face is framed in the viewfinder (not more than five faces).
- 2 The camera selects which face to focus on.
- 3 The face selected appears inside a green frame and the photo is taken automatically.
- 4 If no smile is detected, press the camera key to take the photo manually.

Adding the geographical position to your photos

Turn on geotagging to add the approximate geographical location (a geotag) to photos when you take them. The geographical location is determined either by wireless networks (mobile or Wi-Fi® networks) or GPS technology.



When  appears on the camera screen, geotagging is turned on but the geographical position has not been found. When  appears, geotagging is turned on and the geographical location is available, so your photo can get geotagged. When neither of these two symbols appears, geotagging is turned off.

To turn on geotagging



- 1 Activate the camera.
- 2 If the still camera is not selected, drag  to .
- 3 Press , then tap **Geotagging** > **On**.
- 4 Tap **OK** to agree to enable GPS and/or wireless networks.
- 5 Check the options you want to select under **My Location**.
- 6 After you confirm your settings, press  to return to the camera screen.
- 7 If  appears on the camera screen, your location is available and your photo can get geotagged. If not, check your GPS and/or wireless network connection.

Using still camera settings

To adjust the still camera settings

- 1 Activate the camera.
- 2 If the still camera is not selected, drag  to .
- 3 Tap one of the settings icons on the left of the screen.
- 4 To display all settings, press .
- 5 Select the setting you want to adjust, then edit as desired.

To customise the still camera settings panel

- 1 When the camera is open, press  to display all settings.
 - 2 Touch and hold the setting you want to move and drag it to the desired position.
-  If you drag the setting outside of the settings panel, the change is cancelled.

Still camera settings overview



Normal



Front camera

Select the front camera if you want to take self-portrait photos.



3D Sweep Panorama

3D Sweep Panorama let you to take wide-angle, panoramic photos of any scene in 3D. Just press the camera key and move the camera steadily from one side to the other.



Sweep Multi Angle

In Sweep Multi Angle mode, the camera takes several images at different angles as you sweep across the scene. These images are saved together in an MPO (Multiple Picture Object) file.



Sweep Panorama

Use this setting to take wide-angle, panoramic photos. Just press the camera key and move the camera steadily from one side to the other.

Focus mode

The focus function controls which part of a photo should be sharp. When continuous autofocus is on, the camera keeps adjusting focus so the area within the white focus frame stays sharp.



Single auto focus

The camera automatically focuses on the selected subject. Continuous autofocus is on. Touch and hold the camera screen, the white focus frame turns green when the focus is set. The photo is taken when you release you finger.



Multi auto focus

The focus is automatically set on several areas of the image. Touch and hold the camera screen, the white focus frame turns green when the focus is set. The photo is taken when you release you finger. Continuous autofocus is off.



Face detection

The camera automatically detects up to five human faces, indicated by frames on the camera screen. The camera automatically focuses on the nearest face. You can also select which face to focus on by tapping it on the screen. Touch and hold the camera screen, the white focus frame turns green when the focus is set. The photo is taken when you release you finger. Face detection cannot be used for all scene types. Continuous autofocus is on.



Touch focus

Touch a specific area on the camera screen to set the area of focus. Continuous autofocus is off. Touch and hold the camera screen, the white focus frame turns green when the focus is set. The photo is taken when you release you finger.

-  This setting is only available in **Normal** capturing mode.

Exposure value



Determine the amount of light in the photo you want to take. A higher value indicates an increased amount of light.

! This setting is only available in **Normal** capturing mode.

Image stabiliser

When recording a video, it can be difficult to hold the phone steady. The stabiliser helps you by compensating for small movements of the hand.

 **On**
You can record a video with the stabiliser turned on.

 **Off**
You can record a video with the stabiliser turned off.

Metering

This function automatically determines a well-balanced exposure by measuring the amount of light striking the image you want to capture.

 **Centre**
Adjust the exposure to the centre of the image.

 **Average**
Calculate the exposure based on the amount of light striking the whole image.

 **Spot**
Adjust the exposure in a very small part of image you want to capture.

! This setting is only available in **Normal** capturing mode.

White balance

The white balance setting adjusts the colour balance according to the lighting conditions.

 **Auto**
Adjust the colour balance automatically to the lighting conditions.

 **Incandescent**
Adjusts the colour balance for warm lighting conditions, such as under light bulbs.

 **Fluorescent**
Adjust the colour balance for fluorescent lighting.

 **Daylight**
Adjust the colour balance for sunny outdoor conditions.

 **Cloudy**
Adjust the colour balance for a cloudy sky.

! This setting is only available in **Normal** capturing mode.

Scenes

Use the Scenes feature to quickly set up the camera for common situations using pre-programmed scenes. The camera determines a number of settings for you to fit the selected scene, ensuring the best possible photo.

 **Off**
The Scenes feature is off and photos can be taken manually.

 **Portrait**
Use for portrait photos. Settings are optimised to give slightly softer skin tones.

 **Landscape**
Use for landscape photos. The camera focuses on distant objects. When **Landscape** is selected, focus mode is changed to **Infinity**.

 **Night scene**

Use when taking photos at night or in poorly lit environments (without the flash). Due to long exposure time, the camera must be held still or placed on a stable surface. When **Night scene** is selected, focus mode is changed to **Infinity**.



Night portrait

Use for portrait photos at night or in poorly lit environments (with or without the flash). Due to long exposure time, the camera must be held still or placed on a stable surface.



Beach and snow

Use in bright environments to avoid underexposed photos.



Sports

Use for photos of fast-moving objects. Short exposure time minimises motion blurring.



Party

Use for indoor photos in poorly lit environments. This scene picks up indoor background lighting or candlelight. Due to long exposure time, the camera must be held still or placed on a stable surface.



Document

Use for photos of text or drawings. Gives the photo increased, sharper contrast.

! This setting is only available in **Normal** capturing mode.

ISO

You can reduce image blurring caused by dark conditions or moving subjects by increasing the ISO sensitivity.



Auto

Sets the ISO sensitivity automatically.



100

Sets the ISO sensitivity to 100.



200

Sets the ISO sensitivity to 200.



400

Sets the ISO sensitivity to 400.



800

Sets the ISO sensitivity to 800.

! This setting is only available in **Normal** capturing mode.

Flash

Use the flash to take photos when lighting conditions are poor or when there is a backlight



Auto

The camera automatically determines if the lighting conditions require the use of a flash.



Fill flash

Use this setting when the background is brighter than the subject. This removes unwanted dark shadows.



Off

The flash is turned off. Sometimes photo quality can be better without the flash, even if lighting conditions are poor. Taking a good photo without using the flash requires a steady hand. Use the self-timer to avoid blurred photos.



Red-eye reduction

Reduces the red colour of eyes when taking a photo.

Resolution

Choose between several picture sizes and aspect ratios before taking a photo. A photo with a higher resolution requires more memory.



8MP 4:3

8 megapixel picture size with 4:3 aspect ratio. Suitable for photos you want to view on non-widescreen displays or print in high resolution.



6MP 16:9

6 megapixel picture size with 16:9 aspect ratio. A high resolution widescreen format. Has a higher resolution than full HD. Suitable for photos you want to view on widescreen displays.



2MP 4:3

2 megapixel picture size with 4:3 aspect ratio. Suitable for photos you want to view on non-widescreen displays.



2MP 16:9

2 megapixel picture size with 16:9 aspect ratio. Suitable for photos you want to view on widescreen displays.

Self-timer

With the self-timer you can take a photo without holding the phone. Use this function to take self-portraits, or group photos where everyone can be in the photo. You can also use the self-timer to avoid shaking the camera when taking photos



On (10 s.)

Set a 10-second delay from when you tap the camera screen until the photo is taken.



On (2 s.)

Set a 2-second delay from when you tap the camera screen until the photo is taken.



Off

The photo is taken as soon as you tap the camera screen.

Smile detection

Use the smile detection function to determine what kind of smile the camera reacts to before taking a photo.



Big smile

Only take a photo when a big smile is detected.



Average smile

Take a photo when an average smile is detected.



Small smile

Take a photo when only a slight smile is detected.



Off

Smile detection function is off.

Geotagging



Tag photos with details of where you took them



On

When geotagging is turned on, the approximate geographical location is added to photos when you take them. To use geotagging, you must enable location features from the **Settings** menu.

See *Using location services to find your position* on page 123.

For geotags to be added to a photo, the location must be determined before you take the photo. Your location is determined when  appears on the camera screen. When the phone is searching for your position,  appears.



Off

When geotagging is turned off, you cannot view the location where you took a photo

Shutter sound

Choose to have or not to have the sound when capturing a photo.

Capturing method

Select the method you use to take photos.



On-screen button

Take a photo by tapping the on-screen button on the camera screen. The photo is taken as soon as you release your finger.



Touch capture

Identify a particular focus area by touching the camera screen with your finger. The photo is taken as soon as you release your finger. This applies only when focus mode is set to touch focus.



Camera key only

Take a photo only using the hardware camera key. The photo is taken as soon as you release your finger.

Quick launch

Quick launch settings let you activate the camera from sleep mode by pressing and holding down the camera key.



Launch and capture

By pressing and holding down the camera key, the first photo is captured immediately after the camera is launched from sleep mode.



Launch only

By pressing and holding down the camera key, the camera is launched from sleep mode.



Off

While the phone is in sleep mode, the camera cannot be launched, even when you press and hold down the camera key.

Tips on using the camera

Rule of thirds

Don't place your subject in the middle of the frame. By placing it a third of the way in, you achieve a better result.

Hold it steady

Avoid blurry photos by holding the camera steady. Try to steady your hand by leaning it against a solid object.

Get closer

By getting as close as possible to your subject, you can fill the camera screen view with your subject.

Consider variety

Think about different angles, and move towards the subject. Take some vertical photos. Try different positions.

Use a plain background



A plain background helps highlight your subject.

Keep your lens clean



Mobile phones are used in all kinds of weather and places, and carried in pockets and bags. This results in the camera lens becoming dirty and covered with fingerprints. Use a soft cloth to clean the lens.

Using the video camera

To record a video using the camera key





- 1 Activate the camera.
 - 2 If the video camera is not selected, drag  to .
 - 3 To start recording a video, press the camera key.
 - 4 To stop recording, press the camera key again.
-  Shoot your videos in landscape orientation to get the best results.

To record a video by tapping the screen

- 1 Activate the camera.
- 2 If the video camera is not selected, drag  to .
- 3 To display all settings, press .
- 4 Tap **Capturing method** > **Touch capture** if it is not already selected.
- 5 Tap the camera screen to start recording.
- 6 Tap the camera screen to stop recording.





 Shoot your videos in landscape orientation to get the best results.

To record a video by tapping the on-screen button

- 1 Activate the camera.
- 2 If the video camera is not selected, drag  to .
- 3 To display all settings, press .
- 4 Tap **Capturing method**, then select **On-screen button** if it is not already selected.
- 5 Point the camera towards the subject.
- 6 Tap  to start recording.
- 7 Tap  to stop recording.



 Shoot your videos in landscape orientation to get the best results.

To play recorded videos

- 1 Activate the camera.
- 2 If the video camera is not selected, drag  to .
- 3 Tap the thumbnails on the bottom of the screen.
- 4 Flick left or right to browse all photo and video files. Videos are identified by .
- 5 Tap  to play the video.
- 6 To stop playing the video, tap the camera screen.

 You can also flick the thumbnails from right to left, and select the one you want to view.



To delete a recorded video

- 1 Browse to the video that you want to delete.
- 2 Press , then tap .

 To delete a recently taken photo or video, you can also flick the thumbnail at the bottom right of the viewfinder and then press and hold the item you want to delete.

Using video camera settings

To adjust video camera settings

- 1 Activate the camera.
- 2 If the video camera is not selected, drag  to .
- 3 Tap one of the settings icons on the left of the screen.
- 4 To display all settings, press .
- 5 Select the setting you want to adjust, then make your changes.

To customise the video camera settings panel

- 1 When the video camera is open, press  to display all settings.
- 2 Touch and hold the setting you want to move and drag it to the desired position.

 If you drag the setting outside of the settings panel, the change is cancelled.

Video camera settings overview

Scenes

The Scenes feature helps you to quickly set up the camera for common situations using pre-programmed scenes. The camera determines a number of settings for you to fit the selected scene, ensuring the best possible video.



Off

The Scenes feature is off and you can shoot videos manually.



Portrait

Use for portrait videos. Settings are optimised to give slightly softer skin tones.



Landscape

Use for videos of landscapes. The camera focuses on distant objects. When **Landscape** is selected, focus mode is changed to **Single auto focus**.



Night

When turned on, light sensitivity is increased. Use in poorly lit environments. Videos of fast-moving objects may get blurred. Hold your hand steady, or use a support. Turn off night mode when lighting conditions are good, to improve the video quality.



Beach and snow

Use in bright environments to avoid underexposed videos.



Sports

Use for videos of fast-moving objects. Short exposure time minimises motion blurring.



Party

Use for indoor videos in poorly lit environments. This scene picks up indoor background lighting or candlelight. Videos of fast-moving objects may get blurred. Hold your hand steady, or use a support.

Photo light

Use the light to record videos when lighting conditions are poor or when there is a backlight.



On



Off

Sometimes the video quality can be better without a light, even if lighting conditions are poor.

Metering

This function automatically determines a well-balanced exposure by measuring the amount of light striking the image you want to capture.



Centre

Adjust the exposure to the centre of the image.



Average

Calculate the exposure based on the amount of light striking the whole image.



Spot

Adjust the exposure in a very small part of image you want to capture.

! This setting is only available in **Normal** capturing mode.

Capturing method

Select the method you use to record a video.



On-screen button

Record a video by using the on-screen button on the camera screen.



Touch capture

Identify a particular focus area by touching the camera screen with your finger.



Camera key only

Record a video by using only the hardware camera key.

Focus mode

The focus setting controls which part of a video should be sharp. When continuous autofocus is on, the camera keeps adjusting focus so that the area within the white focus frame stays sharp.



Single auto focus

The camera automatically focuses on the selected subject. Continuous autofocus is on.



Face detection

The camera automatically detects up to five human faces, indicated by frames on the screen. The camera automatically focuses on the nearest face. You can also select which face to focus on by tapping it on the screen. When you tap the camera screen, a green frame shows which face is selected and in focus. Face detection cannot be used for all scene types. Continuous autofocus is on.



Infinity

Use when recording videos from a distance. Focus is set on subjects far away. Subjects close to the camera may be blurred.

Video size

Adjust the video size for different formats.



Full HD

Full HD (Full High Definition) format with 16:9 aspect ratio. 1920×1080 pixels.



HD 720p

HD (High Definition) format with 16:9 aspect ratio. 1280×720 pixels.



VGA

VGA format with 4:3 aspect ratio. 640×480 pixels.



Multimedia message

Record videos suitable for sending in multimedia messages. The recording time of this video format is limited to fit in a multimedia message.

Self-timer

With the self-timer you can record a video without holding the phone. Use it to record group videos where everyone can be in the video. You can also use the self-timer to avoid shaking the camera when recording videos.



On (10 s.)

Set a 10-second delay from when you tap the camera screen until the video begins to record.



On (2 s.)

Set a 2-second delay from when you tap the camera screen until the video begins to record.



Off

The video begins to record as soon as you tap the camera screen.

Exposure value



This setting allows you to determine the amount of light in the image you capture. A higher value indicates an increased amount of light.

White balance

The white balance setting adjusts the colour balance according to the lighting conditions.



Auto

Adjust the colour balance automatically to the lighting conditions.



Incandescent

Adjusts the colour balance for warm lighting conditions, such as under light bulbs.



Fluorescent

Adjust the colour balance for fluorescent lighting.



Daylight

Adjust the colour balance for sunny outdoor conditions.



Cloudy

Adjust the colour balance for a cloudy sky.

Image stabiliser

When recording a video, it can be difficult to hold the phone steady. The stabiliser helps you by compensating for small movements of the hand.



On

You can record a video with the stabiliser turned on.



Off

You can record a video with the stabiliser turned off.

Microphone

Select whether to pick up the surrounding sound when recording videos.



On



Off



Shutter sound

Select to turn on or turn off the shutter sound when you record a video.

3D camera

The 3D camera helps you take wide-angle, panoramic photos that capture more of the scene and add depth to the subject. 3D Sweep Panorama photos can be played back on a TV that supports 3D. In Sweep Multi Angle mode, the camera takes several images at different angles as you sweep across the scene. These images are saved together in an MPO (Multiple Picture Object) file. When you tilt the camera during playback, the camera sensor detects motion and displays the image in a 3D-like view on the camera screen.

To activate the 3D Camera

- From your Home screen, tap , then find and tap .

3D Camera overview



- | | |
|---|--|
| 1 | Switch between still and video camera |
| 2 | Take photos or record video clips |
| 3 | Directional arrow – helps you pan the camera |
| 4 | View photos and videos |
| 5 | Settings bar |

To take a photo in 3D Sweep Panorama mode

- 1 Activate the 3D camera.
- 2 Tap the icon on the top left of the screen, then select **3D Sweep Panorama** if it is not already selected.
- 3 Press the camera key halfway down to lock the focus.
- 4 Press the camera key fully down, then pan the camera from left to right in a steady horizontal movement.

Tips for taking 3D Sweep Panorama photos

Note these limitations when taking 3D photos:

- 3D shooting is not suitable: when the subject is large or not stationary; when the main subject is too close to the camera; and when the subject offers little contrast, such as the sky, a sandy beach, or a lawn.
- 3D images consist of several JPEG images and associated MPO files. If you delete an MPO file on the camera (while it is connected to a computer), you will no longer be able to view the associated JPEG image.
- If you cannot pan the camera across the entire subject within the given shooting time, a grey area occurs in the composite image. If this happens, move the camera faster to record a full 3D image.
- Under low light conditions, images may be blurred. To get the best results, shoot images in bright outside light.
- Under lights that flicker, such as fluorescent lights, 3D shots may not be successful.
- When you press the camera key halfway down, you set the Auto Focus lock and the Auto Exposure lock. If the brightness, focus and other conditions change considerably between the time you set these two locks and the time you press the camera key fully down to take the shot, the shot might not be successful.
- The camera may cancel 3D shooting in the following situations: you pan the camera too quickly; you shake the camera too much; you pan the camera in the reverse direction.

To take a photo in a Sweep Multi Angle mode

- 1 Activate the 3D camera.
- 2 Tap the icon on the top left of the screen, then select **Sweep Multi Angle**.
- 3 Press the camera key halfway down to lock the focus.
- 4 Press the camera key fully down, then pan the camera from left to right in a steady horizontal movement.

To take a photo in Sweep Panorama mode

- 1 Activate the 3D camera.
- 2 Tap the icon on the top left of the screen, then select **Sweep Panorama**.
- 3 Tap  and select the direction in which to pan.
- 4 Press the camera key halfway to lock the focus and exposure.
- 5 Press the camera key fully down, then pan the camera steadily in the direction of the moving arrow.

Tips for taking Sweep Panorama photos (2D)

Note these limitations when you take Sweep Panorama photos:

- If you cannot pan the phone across the entire subject within the given time, a grey area occurs in the composite image. If this happens, move the camera faster to record a full panorama image.
- Since several images are stitched together, the stitched part does not always record smoothly.
- Under low light conditions, panorama images can be blurred or of low quality.
- Under lights that flicker, such as fluorescent lights, the brightness or colour of the combined images may not be consistent.
- Sweep Panorama mode is not suitable for the following situations: when subjects are moving or are too close to the camera; when target images offer little contrast, such as photos of skies, sand beaches, or lawns; and when images change constantly, such as waves or waterfalls.
- The camera can cancel shooting in the following situations: you pan the camera too quickly; you shake the camera too much; you pan the camera in the reverse direction.

Viewing photos and videos in Gallery

Use Gallery to view photos and play videos that you've taken with your phone camera, or to view similar content that you've downloaded or copied to the phone's internal storage. In Gallery, you can also view photos and videos you've uploaded to an online service, for example, to a Picasa™ web album or to Facebook™.

From Gallery, you can also share your favorite photos and videos with friends by using Bluetooth™ wireless technology, email or messaging. And you can perform basic editing tasks on photos and set them as wallpaper or contact pictures. For more information, see *Connecting your phone to a computer* on page 119.



Mobile BRAVIA® Engine

Sony's Mobile BRAVIA® Engine technology improves the viewing quality of photos and videos after you take them, giving you clearer, sharper and more natural images. Mobile BRAVIA Engine is turned on by default, but you can turn it off if you want to reduce battery consumption.

To turn off Mobile BRAVIA® Engine

- 1 From your Home screen, tap .
- 2 Find and tap **Settings** > **Display**.
- 3 Unmark the **Mobile BRAVIA Engine** checkbox if it is already marked.

To open Gallery and view your albums

- 1 From your Home screen, tap .
 - 2 Find and tap **Gallery**. Photos and videos on your phone's internal storage, including those you've taken with the camera and those you've downloaded from the web or other locations, appear in albums.
-  If the screen orientation does not change automatically when you turn the phone sideways, mark the **Auto-rotate screen** checkbox under **Settings** > **Display**.

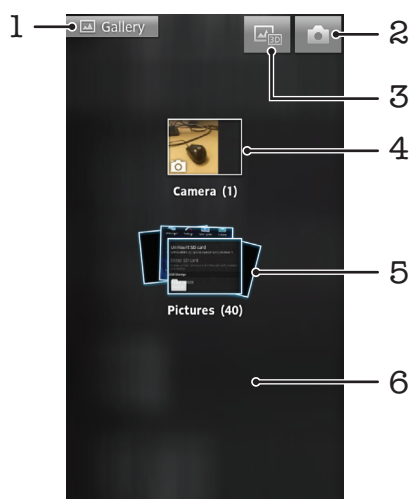

- 1 Tap in any view to return to the main Gallery screen
- 2 Tap to open the camera
- 3 Tap to open 3D Album
- 4 Album of photos and videos taken with the phone camera
- 5 Album stack – touch with two fingers and spread them apart to view the content
- 6 Flick left or right on the screen to view more albums

Working with albums

You can rearrange your photos and videos within albums as well as move content between albums. You can also upload content from your Gallery albums to online services such as Picasa™ and Facebook™, and you view content from such online services in Gallery.



To open an album in Gallery

- 1 From your Home screen, tap .
- 2 Find and tap **Gallery**.
- 3 Tap the album you want to view. The album opens displaying its photo and video content in a chronologically ordered grid. The name of the album appears at the top of the screen.





- 1 Tap to switch from grid to stack view
- 2 The name of the album
- 3 Tap a photo or video to view it
- 4 Tap an arrow to scroll a screen at a time. Drag left or right to scroll rapidly.
- 5 Tap to return to the main Gallery screen



To view photos and videos in Gallery

- 1 From your Home screen, tap .
 - 2 Find and tap **Gallery**.
 - 3 Tap an album. Photos and videos are displayed in a chronologically ordered grid. Videos are indicated by .
 - 4 Tap a photo or video to view it.
 - 5 Flick left to view the next photo or video. Flick right to view the previous photo or video.
-  If the screen orientation does not change automatically when you turn the phone sideways, mark the **Auto-rotate screen** checkbox under **Settings > Display**.

To view Facebook™ photos in Gallery

- 1 Make sure you are signed in to **Facebook™**.
- 2 From your Home screen, tap .
- 3 Find and tap **Gallery**.
- 4 Tap any album showing the  icon. The first time you tap a **Facebook™** album your **Facebook™** photos are copied to Gallery.
- 5 Photos are displayed in a chronologically ordered grid. Tap a photo to view it.
- 6 In the photo viewer, flick left to view the next photo or video. Flick right to view the previous photo or video.
- 7 Return to the main Gallery screen at any time by tapping  at the top left of the screen.



To change how the contents of an album are displayed in Gallery

- 1 When viewing an album in Gallery, drag the album view switch  to the right to view the contents of the album in stacks.
- 2 Drag the album view switch  to the left to view the album contents in a chronological grid.

Working with albums in Gallery

In addition to working with whole albums and with individual photos, you can select one or more photos or videos in an album to work on them in batches, for example, to send a few photos from an album to a friend.

To work with batches of photos or videos in Gallery

- 1 From your Home screen, tap .
- 2 Find and tap **Gallery**.
- 3 Open the album containing the content that you want to work with.
- 4 To activate selection mode, touch and hold one of the items that you want to work with.
- 5 Check or uncheck the items that you want to work with.
- 6 Press , then use the tools in the toolbar to work with your selected items.

To share an album in Gallery

- ! If you share an album, do not delete the original copy of the album before the items in the album are completely sent.
- 1 From the main Gallery screen, touch and hold an album that you want to work with. Selection mode is now activated.
 - 2 Check the albums you want to share, then press .
 - 3 Tap **Share**.
 - 4 In the menu that opens, tap the application that you want to use to share the selected albums.

To delete an album in Gallery

- 1 From the main Gallery screen, touch and hold an album that you want to work with. Selection mode is now activated.
- 2 Check the albums that you want to delete, then press .
- 3 Tap **Delete**. In the dialog that opens, tap **Delete** again.



Working with photos in Gallery

You can edit and reorganise your photos in Gallery. For example, you can crop photos, use them as contact pictures and as wallpaper.

To zoom a photo

- When you are viewing a photo, double-tap the screen to zoom in. Double-tap again to zoom out.
- When you are viewing a photo, spread two fingers apart to zoom in, or pinch two fingers together to zoom out.

To watch a slideshow of your photos

- 1 From your Home screen, tap .
- 2 Find and tap **Gallery**.
- 3 Tap an album to open it, then tap a photo and press .
- 4 In the toolbar at the bottom of the screen, tap **Slideshow**.
- 5 Tap a photo to end the slideshow.

To rotate a photo

- 1 When you are viewing a photo, press .
- 2 Tap **More**, then tap either **Rotate Left** or **Rotate Right**. The photo is saved in the new orientation.

To use a photo as a contact picture

- 1 When you are viewing a photo in the photo viewer, press .
- 2 In the toolbar at the bottom of the screen, tap **Set as > Contact picture**.
- 3 Select the contact you want to associate with the photo.
- 4 Crop the photo, if required.
- 5 Tap **Save**.

To use a photo as wallpaper

- 1 When you are viewing a photo in the photo viewer, press .
- 2 In the toolbar at the bottom of the screen, tap **Set as > Wallpaper**.
- 3 Crop the photo, if required.
- 4 Tap **Save**.

To crop a photo

- 1 When you are viewing a photo in the photo viewer, press .
- 2 In the toolbar, tap **More > Crop**.
- 3 To adjust the crop frame, touch and hold the edge of the crop frame. When crop arrows appear, drag inward or outward to resize the frame.
- 4 To resize all sides of the crop frame at the same time, touch and hold one of the four corners to make the arrows appear, then drag the corner accordingly.
- 5 To move the crop frame to another area of the photo, touch and hold inside the frame, then drag it to the desired position.
- 6 To save a copy of the photo as you cropped it, tap **Save**. The original uncropped version remains on your phone's internal storage.

To share a photo

- 1 When you are viewing a photo in the photo viewer, press  if no controls are displayed.
- 2 In the toolbar at the bottom of the screen, tap **Share**.
- 3 Select one of the available transfer methods.

To delete a photo

- 1 When you are viewing a photo in the photo viewer, press .
- 2 In the toolbar at the bottom of the screen, tap **Delete**.
- 3 In the dialog that opens, tap **Delete**.

Viewing your photos on a map

If you enabled location detection when taking photos, you can use the information gathered at a later stage. For example, you can view your photos on a map and show friends and family where you were when you took the photo. Adding location information is also referred to as geotagging. To geotag your photos, you first need to enable location detection in your phone. You can select to use either GPS satellites or wireless networks, or both, to find your position.

For more information, see *Using location services to find your position* on page 123

To enable location detection

- 1 From your Home screen, press .
- 2 Tap **Settings** > **Location & security**.
- 3 Mark the **Use GPS satellites** and/or **Use wireless networks** checkboxes.

To view geotagged photos on a map

- 1 When you are viewing a photo that you have geotagged, press .
- 2 Tap **More** > **Show on map**.

Working with videos

Use Gallery to watch videos that you've taken with the camera, downloaded, or copied to your phone's internal storage. You can also share your videos with friends, or upload them to YouTube™.

To play a video



- 1 In Gallery, browse to the album containing the video that you want to play.
- 2 Tap the video to play it.
- 3 If the playback controls are not displayed, tap the screen to display them. To hide the controls, tap the screen again.

To pause a video

- 1 When a video is playing, tap the screen to display the controls.
- 2 Tap .

To fast forward and rewind a video

- 1 When a video is playing, tap the screen to display the controls.
- 2 Drag the progress bar marker left to rewind, or right to fast forward.

 Alternatively, you can tap  or .

To adjust the volume of a video

- Press the volume key.

To share a video

- 1 Open a Gallery album containing a video.
- 2 To activate selection mode, touch and hold an item that you want to work with.
- 3 Check the video or videos that you want to share.
- 4 Press .
- 5 Tap **Share**.
- 6 In the menu that opens, tap the application that you want to use to share the selected video, then follow the relevant steps to send it.

 You might not be able to copy, send or transfer copyright-protected items. Also, some items may not send if the file size is too large.

To delete a video

- 1 Open a Gallery album containing a video.
- 2 To activate selection mode, touch and hold an item that you want to work with.
- 3 Check the video or videos that you want to delete.
- 4 Press , then tap **Delete**.
- 5 In the dialog that opens, tap **Delete**.

Viewing photos in 3D Album

In 3D Album you can view and play all photos taken with your 3D camera. You can also play photos that you have taken using Sweep Multi Angle mode and view them from multiple angles.

To view your 3D photos in 3D Album

- 1 From your Home screen, tap .
- 2 Find and tap **3D Album**.
- 3 Tap a 3D photo.
- 4 Flick left to view the next 3D photo in 3D Album. Flick right to view the previous 3D photo.

To play a 3D photo in 3D Album



- 1 Open the 3D photo. If no controls are displayed, tap the screen.
- 2 Tap .

! You can only play 3D photos that have been captured in the standard panorama image size.

To zoom a 3D photo in 3D Album

- When you view a 3D photo in 3D Album, double-tap the photo to zoom in or out.
- 💡 To zoom in or out, you can also pinch two fingers together or spread them apart. Then drag the 3D photo to view different parts of it.

To view multi-angle photos in 3D Album

- 1 From your Home screen, tap .
- 2 Find and tap **3D Album**.
- 3 Tap . All multi-angle photos are displayed.
- 4 Tap a photo.
- 5 Tilt the phone right or left to view the photo from different angles.

Managing your photos in 3D Album

Use 3D Album to upload your 3D photos to online web albums. For example, if you're a Facebook™ user, you can upload your photos in 3D Album to your Facebook™ account. You can also use 3D Album to delete photos.

To share a 3D photo in 3D Album

- 1 When you view a 3D photo in 3D Album, tap the 3D photo if no controls are displayed.
- 2 Tap .
- 3 Select one of the available transfer methods.

To delete a 3D photo in 3D Album

- 1 When you view a 3D photo in 3D Album, tap the photo if no controls are displayed.
- 2 Tap , then tap **OK**.

Bluetooth™ wireless technology

Use the Bluetooth™ function to send files to other Bluetooth™ compatible devices, or to connect to handsfree accessories. Turn on the Bluetooth™ function in your phone and create wireless connections to other Bluetooth™ compatible devices such as computers, handsfree accessories, and phones. Bluetooth™ connections work better within a 10 meter (33 foot) range, with no solid objects in between. In some cases you have to manually pair your phone with other Bluetooth™ devices. Remember to set your phone to "discoverable" if you want other Bluetooth™ devices to detect it.

! Interoperability and compatibility among Bluetooth™ devices can vary.

To turn on the Bluetooth™ function and make your phone visible

- 1 From your Home screen, tap .
- 2 Find and tap **Settings** > **Wireless & networks**.
- 3 Mark the **Bluetooth** checkbox.  appears in the status bar.
- 4 Tap **Bluetooth settings**.
- 5 Mark the **Discoverable** checkbox. The phone will now be visible to other devices for 120 seconds.

Naming your phone

You can give your phone a name. This name is shown to other devices after you have turned on the Bluetooth™ function and your phone is set to visible.

To give your phone a name

- 1 Make sure the Bluetooth™ function is turned on.
- 2 From your Home screen, tap .
- 3 Find and tap **Settings** > **Wireless & networks** > **Bluetooth settings** > **Device name**.
- 4 Enter a name for your phone.
- 5 Tap **OK**.

Pairing with another Bluetooth™ device

When you pair your phone with another device, you can, for example, connect your phone to a Bluetooth™ headset or a Bluetooth™ car kit and use these devices to make and receive calls.

Once you have paired your phone with a Bluetooth™ device the phone will remember this pairing. When pairing the phone with a Bluetooth™ device, you may need to enter a passcode. Your phone will automatically try the generic passcode 0000. If this does not work, refer to your Bluetooth™ device documentation for the device passcode. You do not need to re-enter the passcode the next time you connect to a paired Bluetooth™ device.

Some Bluetooth™ devices, for example, most Bluetooth™ headsets, require you to both pair and connect with the other device.

You can pair your phone with several Bluetooth™ devices, but you can only connect to one Bluetooth™ profile at the same time.

To pair your phone with another Bluetooth™ device

- 1 From the Home screen, tap .
 - 2 Find and tap **Settings** > **Wireless & networks** > **Bluetooth settings**.
 - 3 Tap **Scan for devices**. The Bluetooth™ devices found will be listed under **Bluetooth devices**.
 - 4 Tap the Bluetooth™ device that you want to pair with your phone.
 - 5 Enter a passcode, if required.
 - 6 The phone and the Bluetooth™ device are now paired. With some devices you also need to connect before you can start using them. The status of the pairing and connection is shown below the name of the Bluetooth™ device in the **Bluetooth devices** list.
- ! Make sure that the device you want to pair your phone with has the Bluetooth™ function activated and Bluetooth™ visibility turned on.

To connect your phone to another Bluetooth™ device

- ! Some Bluetooth™ devices, for example, most Bluetooth™ headsets, require you to first pair and then connect with other Bluetooth™ devices before a successful connection can be established.
- 1 From the Home screen, tap .
 - 2 Find and tap **Settings** > **Wireless & networks** > **Bluetooth settings**.
 - 3 In the **Bluetooth devices** list, tap the Bluetooth™ device to which you want to connect your phone.

To unpair a Bluetooth™ device

- 1 From the Home screen, tap .
- 2 Find and tap **Settings** > **Wireless & networks** > **Bluetooth settings**.
- 3 In the **Bluetooth devices** list, touch and hold the name of the paired but not connected Bluetooth™ device.
- 4 Tap **Unpair**.

Sending and receiving items using Bluetooth™ technology



Share items with other Bluetooth™ compatible devices such as phones or computers. You can send and receive several kinds of items using the Bluetooth™ function, such as:

- Photos and videos
- Music and other audio files
- Contacts
- Web pages

To send items using Bluetooth™

- 1 **Receiving device:** Make sure the Bluetooth™ device you want to send the item to has Bluetooth™ turned on and is in discoverable mode.
- 2 In your phone, open the application which contains the item you want to send and scroll to the item.
- 3 Depending on the application and the item you want to send, you may need to, for example, touch and hold the item, open the item or press . Other ways to send an item may exist.
- 4 Select a share or send menu item.
- 5 In the menu that appears, select **Bluetooth**.
- 6 Turn on Bluetooth™, if you are asked to do so.
- 7 Under **Bluetooth devices**, tap the name of the receiving device.
- 8 **Receiving device:** If asked, accept the connection.
- 9 If asked, enter the same passcode on both devices, or confirm the suggested passcode.
- 10 **Receiving device:** Accept the incoming item.

To receive items using Bluetooth™

- 1 From your Home screen, tap .
- 2 Find and tap **Settings** > **Wireless & networks**.
- 3 Mark the **Bluetooth** checkbox.  appears in the status bar.
- 4 Tap **Bluetooth settings**.
- 5 Mark the **Discoverable** checkbox. The phone is now visible to other devices for 120 seconds.
- 6 The sending device should now start sending data to your phone.
- 7 If prompted, enter the same passcode on both devices, or confirm the suggested passcode.
- 8 When you are notified of an incoming file to your phone, drag the status bar downwards and tap the notification to accept the file transfer.
- 9 Tap **Accept** to start the file transfer.
- 10 To view the progress of the transfer, drag the status bar downwards.
- 11 To open a received item, drag the status bar downwards and tap the relevant notification.

Connecting your phone to a computer

Connect your phone to a computer and start transferring pictures, music and other file types. The easiest ways to connect are using a USB cable or Bluetooth wireless technology.

When you connect your phone to the computer using a USB cable, you are prompted to install the PC Companion application on your computer. PC Companion helps you access additional computer applications to transfer and organise media files, update your phone, synchronise phone content, and more.

- ! You might not be able to transfer some copyright-protected material between your phone and computer.

Transferring and handling content using a USB cable

Use a USB cable connection between a computer and your phone for easy transfer and management of your files. Once the two devices are connected, you can drag and drop content between them using the computer's file explorer. If you're transferring music, video, pictures or other media files to your phone, it's best to use the Media Go™ application on your computer. Media Go™ converts media files so that you can use them on your phone.

To transfer content between a phone and computer using a USB cable

- 1 Using a USB cable, connect your phone to a computer. **Internal storage connected** appears in the status bar.
- 2 **Computer:** Open Microsoft® Windows® Explorer from the desktop and wait until your phone's internal storage appears as an external disk in Microsoft® Windows® Explorer.
- 3 **Computer:** Drag and drop the desired files between your phone and the computer.

Transferring files using Media transfer mode via Wi-Fi®

You can transfer files between your phone and other MTP compatible devices, such as a computer, using a Wi-Fi® connection. Before connecting, you first need to pair the two devices. If you're transferring music, video, pictures or other media files between your phone and a computer, it's best to use the Media Go™ application on the computer. Media Go™ converts media files so that you can use them on your phone.

- 💡 In order to use this feature, you need a Wi-Fi® enabled device that supports Media transfer, for example, a computer running Microsoft® Windows Vista® or Windows® 7.

To pair your phone wirelessly with a computer using Media transfer mode

- 1 Make sure Media transfer mode is enabled on your phone. It is normally enabled by default.
 - 2 Connect your phone to the computer using a USB cable.
 - 3 **Computer:** Once the phone name appears on the screen, click *Network configuration* and follow the instructions to pair the computer.
 - 4 When you are finished pairing, disconnect the USB cable from both devices.
- ! The above instructions only work if Windows® 7 is installed on your computer and the computer is connected to a Wi-Fi® Access Point via a network cable.

To connect paired devices wirelessly in Media transfer mode

- 1 Make sure Media transfer mode is enabled on your phone. It is normally enabled by default.
- 2 From your Home screen, tap .
- 3 Find and tap **Settings** > **Xperia™** > **Connectivity**.
- 4 Tap the paired device that you want to connect to under **Trusted devices**.
- 5 Tap **Connect**.

- ! Make sure your phone's Wi-Fi® function is turned on.

To disconnect a wirelessly paired device in Media transfer mode

- 1 From your Home screen, tap .
- 2 Find and tap **Settings** > **Xperia™** > **Connectivity**.
- 3 Tap the paired device that you want to disconnect from under **Trusted devices**.
- 4 Tap **Disconnect**.

To remove a pairing with another device

- 1 From your Home screen, tap .
- 2 Find and tap **Settings** > **Xperia™** > **Connectivity**.
- 3 Tap the paired device that you want to remove.
- 4 Tap **Forget**.

PC Companion

PC Companion is a computer application that gives you access to additional features and services which help you transfer music, video and pictures to and from your phone. You can also use PC Companion to update your phone and get the latest software version available. The installation files for PC Companion are saved on your phone and the installation is launched from the phone when you connect it to a computer via USB cable.

You need an internet connected computer running one of the following operating systems to use the PC Companion application:

- Microsoft® Windows® 7
- Microsoft® Windows Vista®
- Microsoft® Windows® XP (Service Pack 3 or higher)

To install PC Companion

- 1 **New phone:** Turn on your new Android™ phone and connect it to a PC using a USB cable.
- 2 **New phone:** Tap **Install** to install PC Companion on the PC.
- 3 **Computer:** If a popup window appears, select *Run Startme.exe*. In the new popup window that appears, click *Install* to start the installation and then follow the instructions to complete the installation.

To start PC Companion

- 1 Make sure that PC Companion is installed on your PC.
- 2 Open the PC Companion application on the PC, then click **Start** to open one of the features you want to use.

Media Go™

The Media Go™ computer application helps you transfer and manage media content in your phone and computer. You can install and access Media Go™ from within the PC Companion application. See *PC Companion* on page 120 for more information.

You need one of these operating systems to use the Media Go™ application:

- Microsoft® Windows® 7
- Microsoft® Windows Vista®
- Microsoft® Windows® XP, Service Pack 3 or higher

To transfer content using the Media Go™ application

- 1 Connect your phone to a computer using a supported USB cable.
 - 2 **Phone:** In the status bar, **Internal storage connected** appears.
 - 3 **Computer:** Open the PC Companion application on the PC first. In PC Companion, click *Media Go* to start the Media Go™ application. In some cases, you may have to wait for Media Go™ to install.
 - 4 Using Media Go™, drag and drop files between your computer and phone.
-  Media Go™ can also be downloaded from www.sonymobile.com.

Connecting your phone to a TV set

Connect your phone to a TV set using a HDMI™ (High Definition Multimedia Interface) cable, and start viewing content saved in your phone on a larger screen. When you connect your phone to the TV set, the TV Launcher application opens. This application helps you to play media files from your phone on TVs and other devices.

To view phone content on a TV using a HDMI cable connection

- 1 Connect your phone to the TV set using a HDMI™ cable.  appears in your phone's status bar after a connection is established.
- 2 The **TV launcher** application starts automatically. Follow the instructions on your phone screen to view your media files on the TV.

 You may need to purchase a TypeD HDMI™ cable separately. For best results, use a Sony IM-820 cable.

To view help about using the TV remote control

- 1 Drag the status bar downwards to open the Notification panel while the HDMI™ cable is connected to both your phone and the TV set.
- 2 Tap **HDMI connected** to view instructions on how to use the control buttons on your TV's remote control.

 You can also press the yellow button on the TV remote control to open the Notification panel.

To disconnect your phone from the TV set

- Disconnect the HDMI™ cable from your phone or the TV set.

Using location services to find your position

Use your phone to find out where you are. There are two methods: GPS and wireless networks. Enable the wireless networks option if you only need your approximate location, and want it fast. If you want a more exact position, and have a clear view of the sky, enable the GPS option. In situations where the wireless network connection is weak, you should enable both options to ensure that your location is found.

- ! Sony does not warrant the accuracy of any location services including but not limited to navigational services.

To enable GPS

- 1 From the Home screen, tap .
- 2 Tap **Settings** > **Location & security**.
- 3 Mark the **Use GPS satellites** checkbox.

To enable wireless networks

- 1 From your Home screen, tap .
- 2 Tap **Settings** > **Location & security**.
- 3 Mark the **Use wireless networks** checkbox.

Using GPS

Your phone has a global positioning system (GPS) receiver that uses satellite signals to calculate your location.

- ! When you use features that require the GPS receiver to find your location, make sure you have a clear view of the sky.

Getting the best performance

The first time you use the GPS it can take 5 to 10 minutes for your location to be found. To help the search, make sure you have a clear view of the sky. Stand still and don't cover the GPS antenna (the highlighted area in the image). The GPS signals can pass through clouds and plastic, but not through most solid objects such as buildings and mountains. If your location isn't found after a few minutes, move to another location.

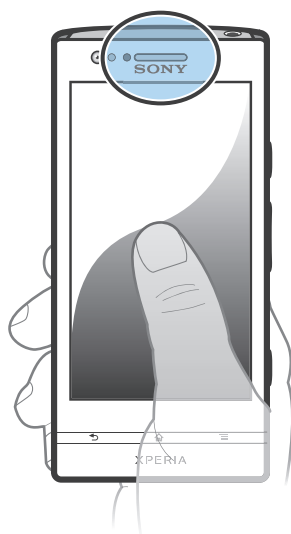

Google Maps™

Track your current location, view real-time traffic situations and receive detailed directions to your destination. Before taking trips, you can download and save maps to your internal storage to avoid high roaming costs.

- ! The Google Maps™ application requires the use of an Internet connection. You may incur data connection charges when you connect to the Internet from your phone. Contact your network operator for more information. The Google Maps™ application may not be available in every market, country or region.

To use Google Maps™

- 1 From the Home screen, tap .
- 2 Find and tap **Maps**.

- ! If you want to use your location, enable at least one of the location methods available under **Settings > Location & security**.

To learn more about Google Maps™

- When you use Google Maps™, press , then tap **Help**.

Viewing your friends' locations with Google Latitude™

Join Google Latitude™ to view your friends' locations on maps and share your location and other information with them.

Using Google Maps™ to get directions

Use the Google Maps™ application to get directions when you travel by foot, public transportation, or car. You can add a shortcut to a destination on your Home screen to get quick directions from wherever you are.

When you view a map, you make an Internet connection, and data is transferred to your phone. So it's a good idea to download and save maps to your phone before you take a trip. This way, you can avoid high roaming costs.

- ! Sony does not warrant the accuracy of any directional services.

Using the Navigation application

Use the Navigation application in your phone to get turn-by-turn instructions on how to get places. The directions are both spoken and displayed on the screen.

- ! The Navigation application may not be available in every market.

To start Navigation

- 1 From your Home screen, tap .
- 2 Find and tap **Navigation**.

Using the Wisepilot™ application

Get turn-by-turn voice instructions on how to get places. You can also manage your trips and share routes and locations with friends via SMS, Twitter™ or Facebook™.

- ! Wisepilot™ may not be available in every market. For more information, including a Wisepilot User manual, go to www.sonymobile.com.

To start Wisepilot™

- 1 From the Home screen, tap .
- 2 Find and tap **Wisepilot**.

Backing up and restoring phone content

Use the Backup and restore application to make backups of phone content to your internal storage or to an online storage account. Such backups can be used to restore your content and some phone settings in cases where your data gets lost or deleted.

Types of content you can back up

Use the Backup and restore application to back up the following types of data:

- Bookmarks
 - Call log
 - Contacts
 - Applications downloaded from Android Market™
 - Multimedia messages
 - System settings (such as alarms, ringer volume)
 - Text messages
- ! You do not need to back up music files and photos or videos taken with the phone camera. They are backed up automatically to the phone's internal storage.
- ! You may incur additional data transmission charges when you restore Android Market™ applications.

Locking and protecting your phone

IMEI number

Every phone has a unique IMEI (International Mobile Equipment Identity) number. You should keep a copy of this number. If your phone is stolen, your network provider can use your IMEI number to stop the phone from accessing the network in your country.

To view your IMEI number

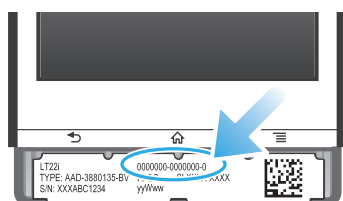

- Remove the cover to view your IMEI number.

To view your IMEI number in the phone

- 1 From the Home screen, tap .
- 2 Find and tap **Settings** > **About phone** > **Status**.
- 3 Scroll to **IMEI** to view the **IMEI** number.

SIM card protection

The SIM card lock only protects your subscription. Your phone will still work with a new SIM card. If the SIM card lock is on, you have to enter a PIN (Personal Identity Number). If you enter your PIN incorrectly more times than the maximum number of attempts allowed, your SIM card will become blocked. You need to enter your PUK (Personal Unblocking Key) and then a new PIN. Your PIN, PIN2 and PUK are supplied by your network operator.

To enable the SIM card PIN lock

- 1 From the Home screen, tap .
- 2 Find and tap **Settings** > **Location & security** > **Set up SIM card lock** > **Lock SIM card**.
- 3 Enter the SIM card PIN and tap **OK**.

To change the SIM card PIN

- 1 From the Home screen, tap .
- 2 Find and tap **Settings** > **Location & security** > **Set up SIM card lock** > **Change SIM PIN**.
- 3 Enter the old SIM card PIN and tap **OK**.
- 4 Enter the new SIM card PIN and tap **OK**.
- 5 Re-type the new SIM card PIN and tap **OK**.

To change the SIM card PIN2

- 1 From the Home screen, tap .
- 2 Find and tap **Settings** > **Call settings** > **Fixed Dialing Numbers** > **Change PIN2**.
- 3 Enter the old SIM card PIN2 and tap **OK**.
- 4 Enter the new SIM card PIN2 and tap **OK**.
- 5 Confirm the new PIN2 and tap **OK**.

To unblock a locked SIM card

- 1 When **SIM card locked** appears, enter the PUK code and tap **OK**.
- 2 Enter a new PIN code and tap **OK**.
- 3 Reenter the new PIN code and tap **OK**.

! If you enter an incorrect PUK code too many times, the SIM card becomes blocked. If this happens, contact your service provider to get a new SIM card.

Setting a screen lock

To set a screen lock

- 1 From your Home screen, tap  > **Settings** > **Location & security** > **Set up screen lock**.
- 2 Select an option.

💡 It is very important that you remember your screen unlock pattern, PIN or password. If you forget this information, it may not be possible to restore important data such as contacts and messages. Refer to Sony Customer support for more information.

To create a screen unlock pattern

- 1 From the Home screen, tap .
- 2 Find and tap **Settings** > **Location & security** > **Set up screen lock** > **Pattern**.
- 3 Follow the instructions in your phone. You are asked to select a security question that will be used to unlock the phone if you forget your screen unlock pattern.

To unlock the screen using a screen unlock pattern

- 1 Activate the screen.
- 2 Drag the lock icon  to the right across the screen.
- 3 Draw your screen unlock pattern.

! If the unlock pattern you draw on the screen is rejected five times in a row, you can select to either wait 30 seconds and then try again, or to answer the security question you have selected.

To change the screen unlock pattern

- 1 From the Home screen, tap .
- 2 Find and tap **Settings** > **Location & security** > **Change screen lock**.
- 3 Follow the instructions in your phone.

To disable the screen unlock pattern

- 1 From your Home screen, tap  > **Settings** > **Location & security** > **Change screen lock**.
- 2 Draw the screen unlock pattern.
- 3 Tap **None**.

To create a screen unlock PIN

- 1 From your Home screen, tap  > **Settings** > **Location & security** > **Set up screen lock** > **PIN**.
- 2 Enter a numeric PIN and tap **Continue**.
- 3 Confirm your PIN and tap **OK**.

To disable the screen unlock PIN

- 1 From your Home screen, tap  > **Settings** > **Location & security** > **Change screen lock**.
- 2 Enter your PIN and tap **Continue**.
- 3 Tap **None**.

To create a screen lock password

- 1 From your Home screen, tap  > **Settings** > **Location & security** > **Set up screen lock** > **Password**.
- 2 Enter a password. The password must contain at least one letter and must be at least four characters long.
- 3 Tap **Continue**.
- 4 Confirm your password and tap **OK**.

To disable the screen unlock password

- 1 From your Home screen, tap  > **Settings** > **Location & security** > **Change screen lock**.
- 2 Enter your password and tap **Continue**.
- 3 Tap **None**.

Updating your phone

Update your phone to the most recent software version to get optimal performance and the latest enhancements.

You can use the Update center application on your phone to run a wireless update or you can use the PC Companion application on a computer to run an update using a USB cable connection. If you update wirelessly, then you can use either a mobile network or a Wi-Fi® network connection. Just make sure you back up and save all data stored on your phone before you update.

- ! When you run an update using the Update center application, a data connection is established and related charges may be incurred. Also, the availability of updates over a mobile network depends on your operator. Contact your network operator for more information.

Updating your phone wirelessly



Use the Update center application to update your phone wirelessly. You can download software updates manually, or you can allow Update service to update your phone automatically whenever downloads become available. When the automatic update feature is activated, a notification appears in the status bar every time an update becomes available.

To download software updates manually from Update center

- 1 From your Home screen, tap .
- 2 Find and tap **Update Centre**.
- 3 Select the desired application or system update and tap **Download**, or tap **Update all** to download all application updates.

- ! Application updates launch automatically after download. With system updates, wait for your phone to restart, then install the update manually. Also, You may incur data connection charges when downloading updates over 3G/mobile networks.

To activate automatic software updates from Update center

- 1 From your Home screen, tap .
- 2 Find and tap **Update Centre**.
- 3 Press , then tap **Settings**.
- 4 Tap **Allow automatic update**: and select whether to download updates via 3G and Wi-Fi® networks, or via Wi-Fi® networks only. Updates are now downloaded automatically as soon as they become available.

- ! You may incur data connection charges when downloading updates over 3G/mobile networks.

To install system updates

- 1 From your Home screen, tap .
- 2 Find and tap **Update Centre**.
- 3 Select a system update you want to install, then tap **Install**.

Updating your phone using a USB cable connection

Some updates are not available for wireless download. Notifications appear in the status bar to inform you of such updates. To download and run the updates, you need a USB cable and a computer running the PC Companion application. You can install PC Companion on the computer using installation files saved on your phone, or you can download the application directly from www.sonymobile.com.

To download the PC Companion application from your phone

- 1 Connect your phone to a computer using a USB cable.
- 2 When prompted, follow the instructions in the phone to launch the installation of PC Companion on the computer.

 PC Companion can also be downloaded from www.sonymobile.com.

To download software updates using a USB cable connection

- 1 Install the PC Companion application on the computer you are using, if it is not already installed.
- 2 Connect your phone to the computer using a USB cable.
- 3 **Computer:** Launch the PC Companion application. After a few moments, PC Companion detects your phone and searches for new phone software.
- 4 **Phone:** When notifications appear in the status bar, follow the on-screen instructions to carry out the relevant software updates.

To update your phone using an Apple® Mac® computer

- 1 Install the Bridge for Mac application on the Apple® Mac® computer you are using, if it is not already installed.
- 2 Using a USB cable, connect your phone to the Apple® Mac® computer.
- 3 **Computer:** Launch the Bridge for Mac application. After a few moments, Bridge for Mac detects your phone and searches for new phone software.
- 4 **Computer:** If a new phone software update is detected, a popup window appears. Follow the on-screen instructions to carry out the relevant software updates.

 The Bridge for Mac application is downloadable from www.sonymobile.com.

Phone settings overview



Get to know the settings in your phone so that you can personalise them to your own requirements.

Wireless & networks	Manage your wireless connections and connection settings.
Call settings	Configure settings for listening to and managing your voicemail, for example.
Sound	Configure how your phone rings, vibrates, or alerts you in other ways when you receive communications. You can also use these settings to set the volume for music or other media with audio, and some related settings.
Display	Select to switch orientation when you rotate your phone, or set the screen brightness.
Location & security	Set navigation settings and protect your phone by setting up different locks and passwords.
Applications	Manage and remove installed applications.
Accounts & sync	Enable your applications to sync automatically and permit applications to synchronise data in the background, whether or not you are actively working in them.
Privacy	Manage your personal information, restore your settings and other data when you install an application, and erase all of your personal data from internal phone storage.
Storage	Check out the available space on your phone's internal storage.
Language & keyboard	Select phone language and adjust text input options.
Voice input & output	Configure the voice input feature to enter text by speaking.
Accessibility	Enable your installed accessibility applications and adjust related settings.
Date & time	Set the time and date or choose to use the network-provided values. Select your preferred date and hour format.
About phone	View information about your phone, such as model number, firmware version and battery status.

Status and notification icons overview



Status icons













The following status icons may appear on your screen:

	Signal strength
	No signal
	Roaming
	GPRS is available
	EDGE is available
	3G is available
	Sending and downloading GPRS data
	Sending and downloading EDGE data
	Sending and downloading 3G data
	Battery status
	The battery is charging
	GPS is activated
	Airplane mode is activated
	The Bluetooth™ function is activated
	Connected to another Bluetooth™ device
	The SIM card is not inserted
	The microphone is muted
	The speakerphone is on
	Silent mode
	Vibrate mode
	An alarm is set
	Synchronisation is ongoing
	Problem with sign-in or synchronisation
	A Wi-Fi® connection is enabled and wireless networks are available





Notification icons





The following notification icons may appear on your screen:

	New email message
	New text message or multimedia message
	New voicemail

-  An upcoming calendar event
-  A song is playing
-  The phone is connected to a computer via a USB cable
-  Warning message
-  Error message
-  Missed call
-  Call ongoing
-  Call on hold
-  Call forwarding on
-  Software updates available
-  Downloading data
-  Uploading data
-  More (undisplayed) notifications

Application overview

	Alarm	Set an alarm
	Browser	Browse the web
	Calculator	Perform basic calculations
	Calendar	Keep track of your appointments
	Camera	Take photos and record video clips
	Contacts	Keep track of your friends and colleagues
	3D Album	View photos and pictures in 3D presentation mode
	3D Camera	Create wide-angle, panoramic pictures
	Downloads	Access your downloaded applications
	Email	Send and receive emails
	Facebook™	Connect with your friends, family members and colleagues around the world
	FM radio	Listen to the radio in your phone
	Gallery	View your pictures and photos
	Gmail™	An email application that supports Gmail™
	Google Search	Find information in your phone and on the web
	Latitude	View your friends' locations on Google Maps™ and share your location and other information with them
	Maps	View your current location, find other locations and calculate routes
	Market	Go to Android Market™ to download free and paid applications for your phone
	Connected Devices	Share media files in your phone with other devices over a shared Wi-Fi® connection
	Messaging	Send and receive text and multimedia messages
	Music player	Play music and playlists
	Navigation	Navigate using spoken, turn-by-turn driving instructions
	News and Weather	View news stories and weather forecasts
	Phone	Make and receive calls, switch between calls, set up conference calling and view your call history
	Places	Search for places, for example, restaurants and cafés
	Video Unlimited	Rent and purchase videos
	Music Unlimited	Listen to music online
	Settings	Tailor phone settings to your own liking
	Setup guide	Explains basic functions and helps with essential settings

	Talk	Chat online
	TrackID™	A music recognition service
	Timescape™	Keep track of all daily communication
	YouTube™	Share and view videos from around the world

! Some applications are not supported by all networks and/or service providers in all areas.

User support

Access user support directly in your phone through the Help application. For example, you can open a User guide with instructions on how to use your phone. You can also get troubleshooting and other help from the Sony Mobile support zone, and from the Sony Mobile Customer support service.

- Help application features:
 - User guide in the phone – read and search information on how to use your phone.
 - Educate yourself – read tips and tricks, get the latest news, and watch how-to videos.
 - Email support – send an email to our support team.
 - Support zone – visit www.sonymobile.com to get comprehensive support for your phone.
 - Troubleshooting – find common problems and error messages at the end of our User guides and on the support zone.
 - Customer support – if all else fails. The relevant support numbers are listed in the supplied *Important information* leaflet.
- ! An extended User guide is also available at www.sonymobile.com.

To access the Help application

- 1 From your Application screen, find and tap .
- 2 Find and tap the required support item.

Troubleshooting

My phone is not working as expected

If you experience problems with your phone, check these tips before you try anything else:

- Charge your phone if the battery level gets low.
- Use the power key to restart your phone.
- Try restarting your phone by removing and reinserting the SIM card.
- Force a restart of the phone. Press and hold both the power  key and the volume up key for five seconds. After the phone vibrates once, release the keys. The phone restarts automatically.
- Update your phone software. Updating your phone ensures optimal performance and provides the latest enhancements. See *Updating your phone* on page 129 for more information.
- Reset your phone.

To force restart your phone

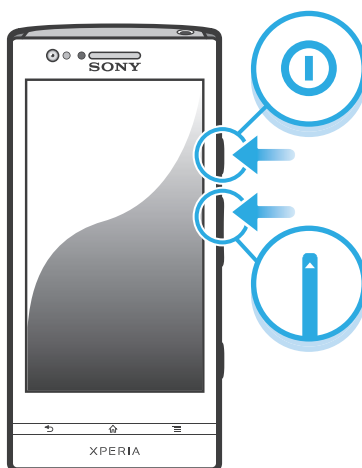

- 1 Press and hold both the volume up key and the power  key for five seconds.
- 2 After your phone vibrates once, release the keys. The phone restarts automatically.

To force a phone shutdown

- 1 Press and hold both the volume up key and the power  key for 10 seconds.
- 2 After your phone vibrates three times, release the keys. The phone turns off automatically.

Resetting the phone

You can reset your phone to its original settings, with or without deleting all of your personal data. It is possible to reset the phone to the state it was in before you first turned it on. But before you perform a reset, make sure to back up any important data saved on your phone.

To reset the phone

-  To avoid permanent phone damage, do not restart the phone while a reset procedure is underway.

- 1 From your Home screen, tap .
- 2 Find and tap **Settings** > **Privacy**.
- 3 Tap **Factory data reset**.
- 4 Tap **Reset phone**.
- 5 To confirm, tap **Erase everything**.

No battery charging icon appears when phone starts charging

It may take a few minutes before the battery icon appears on the screen.

The battery performance is low

Follow our smart tips on how to get more out of your battery. See *Improving battery performance* on page 15.

I cannot transfer content between my phone and the computer, when using a USB cable

The software or the USB drivers have not been properly installed. Go to www.sonymobile.com for more detailed installation instructions and troubleshooting sections.

I cannot use Internet-based services

Make sure your subscription covers data downloads and that the Internet settings in your phone are correct. See *Internet and messaging settings* on page 32 for more information on how to enable data traffic, data roaming, and download Internet settings. Contact your network operator for more information about your subscription settings.

Error messages

No network coverage

- Your phone is in Airplane mode. Make sure Airplane mode is turned off.
- Your phone is not receiving any network signal, or the received signal is too weak. Contact your network operator and make sure that the network has coverage where you are.
- The SIM card is not working properly. Insert your SIM card in another phone. If this works, it is probably your phone that is causing the problem. In this case, contact the nearest Sony service center.

Emergency calls only

You are within range of a network, but you are not allowed to use it. However, in an emergency, some network operators allow you to call the international emergency number 112. See *Emergency calls* on page 35 for more information.

SIM card is locked.

You have entered your PIN incorrectly 3 times in a row. To unlock the phone, you need the PUK provided by your operator.

SIM card is PUK-locked.

You have entered your PUK (Personal Unblocking Key) incorrectly 10 times in a row. Please contact your service provider.

Recycling your phone

Got an old phone lying around the house? Why not recycle it? By doing so, you will help us reuse its materials and components, and you'll protect the environment, too! Find out more about the recycling options in your region at www.sonymobile.com.

Legal information

Sony LT22i

This User guide is published by Sony Mobile Communications AB or its local affiliated company, without any warranty. Improvements and changes to this User guide necessitated by typographical errors, inaccuracies of current information, or improvements to programs and/or equipment, may be made by Sony Mobile Communications AB at any time and without notice. Such changes will, however, be incorporated into new editions of this User guide.

©Sony Mobile Communications AB, 2012.

All rights reserved.

Publication number: 1262-7679.1

Your mobile phone has the capability to download, store and forward additional content, for example, ringtones. The use of such content may be restricted or prohibited by rights of third parties, including but not limited to restriction under applicable copyright laws. You, and not Sony, are entirely responsible for additional content that you download to or forward from your mobile phone. Prior to your use of any additional content, please verify that your intended use is properly licensed or is otherwise authorized. Sony does not guarantee the accuracy, integrity or quality of any additional content or any other third party content. Under no circumstances will Sony be liable in any way for your improper use of additional content or other third party content.

This User guide may reference services or applications provided by third parties. Use of such programming or services may require separate registration with the third party provider and may be subject to additional terms of use. For applications accessed on or through a third-party website, please review such websites' terms of use and applicable privacy policy in advance. Sony does not warrant or guarantee the availability or performance of any third-party websites or offered services.

Remove the bottom cover to see regulatory information such as the CE mark.

All product and company names mentioned herein are the trademarks or registered trademarks of their respective owners. Any rights not expressly granted herein are reserved. All other trademarks are property of their respective owners.

Visit www.sonymobile.com for more information.

All illustrations are for illustration purposes only and may not accurately depict the actual phone.

This product is protected by certain intellectual property rights of Microsoft. Use or distribution of such technology outside of this product is prohibited without a license from Microsoft.

Content owners use Windows Media digital rights management technology (WMDRM) to protect their intellectual property, including copyrights. This device uses WMDRM software to access WMDRM-protected content. If the WMDRM software fails to protect the content, content owners may ask Microsoft to revoke the software's ability to use WMDRM to play or copy protected content. Revocation does not affect unprotected content. When you download licenses for protected content, you agree that Microsoft may include a revocation list with the licenses. Content owners may require you to upgrade WMDRM to access their content. If you decline an upgrade, you will not be able to access content that requires the upgrade.

This product is licensed under the MPEG-4 visual and AVC patent portfolio licenses for the personal and non-commercial use of a consumer for (i) encoding video in compliance with the MPEG-4 visual standard ("MPEG-4 video") or the AVC standard ("AVC video") and/or (ii) decoding MPEG-4 or AVC video that was encoded by a consumer engaged in a personal and non-commercial activity and/or was obtained from a video provider licensed by MPEG LA to provide MPEG-4 and/or AVC video. No license is granted or shall be implied for any other use. Additional information including that relating to promotional, internal and commercial uses and licensing may be obtained from MPEG LA, L.L.C. See <http://www.mpegla.com>. MPEG Layer-3 audio decoding technology licensed from Fraunhofer IIS and Thomson.

Index

3D Camera	
overview	108
screen	108
3D photos	115
deleting	115
playing	115
sharing	115
viewing	115
zooming	115
A	
accounts	11
Exchange Active Sync®	11
Facebook™	11
Google™	11
adjusting volume	87
Airplane mode	30
alarm	64
albums	
deleting	112
Android Market™	58
Android™	8
animated wallpaper	20
answering service	36
applications	8
overview	134
screen	20
audio	89
adjusting volume	87
playing	86
playing music in random order	89
B	
back up	
contacts	43
backing up	
contacts	125
content	125
battery	14
Bluetooth™ wireless technology	116
BRAVIA® Engine	110
brightness	30
<i>browsing - See web browser</i>	
business cards	
sending	43
C	
calendar	64
create an event	64
calling	31
calls	35, 38
barring	38
diverting	38
emergency	35
forwarding	38
list	36
log	36
missed	36
multiple	37
recent	36
settings	38
waiting	37
camera	96, 98, 99, 104
closing	96
continuous auto focus	99, 105
controls	96
face detection	97, 98
geotagging	98
HD (High Definition) video	105
icons	105
overview	96
recording videos	103, 104
screen	96
self-portraits	97
settings	99, 104, 105
smile detection	98
taking photos	97, 98
using the flash	97
video	103
viewing photos	97
viewing videos	104
zoom	97
caps lock	24
changing music tracks	87
charging	14
chat	52
conference calls	37
contacts	39
back up	43
copy	43
favourite	42
importing from SIM card	40
joining contact information	42
picture	41, 113
sending	43
sharing	43
transferring	40
corporate email, calendar and contacts	68
cropping	
photos	113
D	
Data monitor	33
date	
format	29
deleting	112
3D photos	115
an alarm	64
photos	113
tracks	87
videos	114
download	
Internet settings	32
driving directions	124
E	
email	47
more than one account	50
emergency numbers	35
equalizer	87
events	
calendar	64
in Timescape™	54
extensions	18
F	
face detection	97, 98
Facebook™	92, 95
logging in to	54
recommending music player tracks	88
recommending radio tracks	92
status update	54
synchronisation	69
favourites	
moving between in the radio	94

removing radio channels as	94
saving radio channels as	94
filter	
events in Timescape™	54
fixed dialling	38
flash	
using when taking photos	97
Flight mode	30
FM radio	
favourites	94
selecting channel	93
force restart	137
front camera	96
G	
Gallery	110, 115
changing views	112
opening	110
opening albums	111
viewing Facebook™ photos	112
geotagging	
of photos	98
Gesture input	25
Gmail™	50
Google Latitude™	124
Google Maps™	124
Google Talk™	52
Google™ account setup	51
Google™ synchronisation	68
GPS	123
H	
HD (High Definition) video	105
HDMI	122
headset	
using	32
Home screen	18
customising	19
I	
icons	132
in the camera	105
importing SIM contacts	40
Improving photos with Mobile BRAVIA® Engine ..	110
infinite button	88
in Timescape™	55
instant messaging	52
Internet	
controlling data traffic	33
settings	32
web browser	81
K	
keyboard	24
settings	27
keys	16
L	
language	30
writing	27
Latitude	124
LCD backlight control	30
live wallpaper	20
location	98, 123
locks	
activating the screen	10
locking the screen	10
screen lock	10
lockscreen	
viewing missed calls	10
viewing new text messages	11
M	
<i>mail See email</i>	
Maps	124
media files	
copying to internal storage	86
Media Go™	120
messages	
settings	32
Microsoft® Exchange synchronisation	68
MMS	
settings	32
Mobile BRAVIA® Engine	110
multi-angle	
viewing	115
multimedia	
copying to internal storage	86
music	31, 86, 89
adding tracks to playlists	90
adjusting volume	87
changing music tracks	87
copying to internal storage	86
copying to/from a computer	86
creating playlists	90
deleting	87
downloading music information	89
hearing protection	86
My playlists	90
pausing a track	87
player overview	86
playing	86
playing in random order	89
podcasts	86
purchasing	91
recommending	91
searching using TrackID™	91
sharing	88, 92
shortcuts	89
using a headset	32
using the equalizer	87
music player	
creating playlists	90
deleting tracks	87
equalizer	87
minimising	87
My music	88
playlists	90
SensMe™ channels	89
surround sound	87
music player widget	90
Music Unlimited™	63
N	
Navigation application	124
new services	54
notification	132
light	22
panel	23
ringtone	29
O	
on-screen keyboard	24
overview	
phone	86
P	
pausing a track	87
personal information	39
phone	
battery	15
performance	15
update	129
phonebook	39

Phonepad	24, 26	rotating	
photo albums	111	photos	113
deleting	112	S	
viewing	110	scanning barcodes	67
photos	112, 113	screen	30
adding the geographical position	98	cracked	16
associating with a contact	41	glass	16
copying to/from a computer	86	screen unlock pattern	126
cropping	113	warranty	16
deleting	113	searching	
photo viewer	111	music using TrackID™	91
rotating	113	track information	91
sharing	112, 113	self-portrait	96
slideshow	113	sending	112, 113, 115
taking	97, 98	business cards	43
using as a contact picture	113	contacts	43
using as wallpaper	113	sending items using Bluetooth™	117
viewing	97, 110, 111, 112, 115	SensMe™ channels	89
viewing on a map	113	services	11
viewing same location	98	settings	
zooming	112	call	38
PIN	126	camera	99, 104
playing		Internet	32
3D photos	115	messaging	32
music	86	MMS	32
playlists	90	still camera	99
adding a track	90	Timescape™	55
creating	90	video camera	104
deleting	90	setup guide	10
playing your own	90	sharing	
removing tracks	90	3D photos	115
power saver	15	music	88, 92
activating	15	photos	113
changing settings	16	photos and videos	112
deactivating	16	shuffle music	89
displaying notifications	16	silent mode	28
power saving mode	15	SIM card	126
powering off	9	exporting contacts to	43
powering on	9	importing contacts from	40
presets		slideshow	113
removing radio channels as	94	smile detection	98
saving radio channels as	94	SOS <i>See emergency numbers</i>	
protective plastic sheet	16	status	132
PUK	126	bar	22
purchasing		still camera	96
music	91	settings	99
R		symbols	24
radio	93	synchronising	68
favourites	94	calendar, bookmarks	12, 70
listening to with the speaker	94	contacts	12, 70
mono sound	94	Facebook™ contacts, calendar, photos	69
moving between channels	93	Google™ contacts, calendar, email	68
opening	93	Microsoft® Exchange contacts, calendar, email	68
overview	93	SyncML™	12, 70
searching for channels	94	T	
selecting channel	93	taking photos	96
stereo sound	94	by tapping	97
using with Facebook™	95	self-portraits	97
receiving items using Bluetooth™	117	using face detection	98
recent calls	36	using smile detection	98
recently used applications window	21	<i>telephony See calls</i>	
recommending music	88, 91	text input method	24
recording videos	96	themes	20
using the camera key	103	tiles	53
recycling your phone	139	time	29
related audio content	88	time management	64
resetting	137	Timescape™	53, 54
resizing		filter icons	54
photos	113		
ringtone	64		

infinite button in	55	volume	
screen overview	53	adjusting for videos	114
settings	55	key	28
Timescape™ Feed widget	55	W	
Timescape™ Friends widget	56	wallpaper	20
Timescape™ Share widget	57	using a photo as	113
widgets	56, 57	web browser	81
TrackID™ technology	91	managing bookmarks	82
buying a track	91	settings	84
opening	91	toolbar	81
recommending a track	91	Wi-Fi®	75
searching for track information	91	widgets	
sharing a track	92	introduction	19
using results	91	Timescape™ Feed	55, 56
using with Facebook™	92	Timescape™ Friends	56, 57
using with the FM Radio	92, 95	Timescape™ Share	57
viewing charts	91	wireless networks	123
viewing history	91	Wisepilot™	124
transferring		Z	
contacts	40	zoom	97
troubleshooting	137	zooming	
turning off	9	3D photos	115
turning on	9	photos	112
Twitter™			
logging in to	54		
status update	54		
U			
update			
status	54		
updating phone	129		
usage info	33		
USB connection	119		
V			
vibration	29, 64		
video albums	111, 112		
viewing	110		
video camera	96, 103		
continuous auto focus	105		
HD (High Definition) video	105		
recording videos	104		
settings	104, 105		
video player			
pausing a video	114		
Video Unlimited™	61		
buying videos	61		
creating an account	61		
menu overview	61, 62		
notifications	62		
renting videos	61		
watching a video	62		
videos	114		
adjusting volume	114		
copying to/from a computer	86		
deleting	114		
fast forwarding and rewinding	114		
pausing	114		
playing	114		
recording	103, 104		
sending	114		
sharing	114		
viewing	104, 110, 111, 112		
viewing			
photos	97		
videos recorded using the camera	104		
voice input	27		
voice recognition	27		
voicemail	36		