



HP Slate 2 Tablet PC

Maintenance and Service Guide

© Copyright 2011 Hewlett-Packard
Development Company, L.P.

Bluetooth is a trademark owned by its proprietor and used by Hewlett-Packard Company under license. Intel is a trademark of Intel Corporation in the U.S. and other countries. Microsoft, Windows, and Windows Vista are U.S. registered trademarks of Microsoft Corporation. SD Logo is a trademark of its proprietor.

The information contained herein is subject to change without notice. The only warranties for HP products and services are set forth in the express warranty statements accompanying such products and services. Nothing herein should be construed as constituting an additional warranty. HP shall not be liable for technical or editorial errors or omissions contained herein.

First Edition: November 2011

Document Part Number: 664643-001

Safety warning notice

⚠ WARNING! To reduce the possibility of heat-related injuries or of overheating the device, do not place the device directly on your lap or obstruct the device air vents. Use the device only on a hard, flat surface. Do not allow another hard surface, such as an adjoining optional printer, or a soft surface, such as pillows or rugs or clothing, to block airflow. Also, do not allow the AC adapter to contact the skin or a soft surface, such as pillows or rugs or clothing, during operation. The device and the AC adapter comply with the user-accessible surface temperature limits defined by the International Standard for Safety of Information Technology Equipment (IEC 60950).

Table of contents

1 Product description	1
2 External component identification	4
Identifying the hardware	4
Top edge	5
Bottom edge	5
Right edge	6
Opening the label tray	7
Left-edge	8
Display	9
Rear	9
3 Illustrated parts catalog	10
Identifying the labels	10
HP Slate 2 component spare part numbers	12
4 Removal and replacement procedures	18
Preliminary replacement requirements	18
Service considerations	18
Plastic parts	18
Cables and connectors	18
Drive handling	19
Grounding guidelines	19
Electrostatic discharge damage	19
Packaging and transporting guidelines	21
Workstation guidelines	21
Equipment guidelines	22
Component replacement procedures	23
Identifying the labels	23
Digital pen	24
HP Slate Dock	25

5 BIOS Setup	26
Starting BIOS Setup	26
Using BIOS Setup	26
Changing the language of BIOS Setup	26
Navigating and selecting in BIOS Setup	27
Displaying system information	27
Restoring factory settings in BIOS Setup	28
Exiting BIOS Setup	28
Updating the BIOS	29
Determining the BIOS version	29
Downloading a BIOS update	30
BIOS Setup Menu	32
Main menu	32
Diagnostics menu	32
System Configuration menu	32
6 Specifications	33
Operating environment	33
Input power	34
7 Backup and recovery	35
Using Windows Backup and Restore	35
Using system restore points	35
When to create restore points	36
Creating a system restore point	36
Restoring to a previous date and time	36
8 Power cord set requirements	37
Requirements for all countries	37
Requirements for specific countries and regions	38
9 Recycling	40
Index	41

1 Product description

Category	Description
Product Name	HP Slate 2 Tablet PC
Processor	Intel® Atom Lincroft Z670 1.50-GHz processor (512-KB L2 cache, 667-MHz front side bus (FSB))
Chipset	Intel SM35 System Controller Hub (SCH)
Graphics	Intel Graphics Media Accelerator 600
Panel	8.9-in, WSVGA (1024×600), AntiGlare, multitouch capacitive digitizer, AntiGlare type, chemically-strengthened glass, with digital pen, typical brightness: 200 nits
Memory	DDR2 memory built into system board, not customer-accessible/upgradable Memory support: <ul style="list-style-type: none">• DDR2 800 MHz (downgrade to 533 MHz due to chipset limitation)• DDR2 667 MHz (downgrade to 533 MHz due to chipset limitation)• DDR2 533 MHz single channel support Supports 2048-MB total system memory (2048 MB×1) on system board (8 components, 128 MB×16 chips) running at 533-MHz configuration
Primary storage	Supports 64- and 32-GB solid-state drive (SSD)
Optical drives	No support for internal or USB-powered optical drive
Audio and video	One digital microphone HD audio Two integrated 1.5-W, non-branded stereo speakers, supporting SRS Premium sound Two fixed integrated webcams: <ul style="list-style-type: none">• User-facing webcam using OV-7740 sensor with 2-pixel, F2.4 fixed-focus low-light lens supporting 640×480 by 24 frames per second• Rear-facing webcam using OV-3642 sensor with 4-pixel, F2.8 fixed-focus lens supporting extended depth of field (EDoF) feature, 3-megapixel stills, and video up to 24 frames per second
Modem	No support for modem
Ethernet	No support for Ethernet

Category	Description
Wireless	Integrated wireless local area network (WLAN) option by way of Broadcom 4313 802.11b/g/n WiFi and 2070 Bluetooth 2.1+EDR Combo adapter (Bluetooth 3.0+HS ready)
	WLAN antennas built into HP Slate 2
	Supports no WLAN option
	Integrated wireless wide area network (WWAN) option by way of Qualcomm Gobi3000 HSPA/CDMA with GPS
	WWAN antennas built into HP Slate 2
	Supports no WWAN option
External media card	Supports the following optional digital card formats: <ul style="list-style-type: none"> • Secure Digital High Capacity (SDHC) Memory Card (standard and large size) • xD-Picture card
Ports	<ul style="list-style-type: none"> • HP Slate 2 proprietary AC power • HP Slate 2 proprietary docking • Combination audio-in (mono microphone)/audio-out (stereo headphone) • USB 2.0
Docking	Supports HP Slate Dock (ports include two USB 2.0 ports, one HDMI-out port, one combination audio-in/audio-out jacks, and one power connector)
Keyboard/pointing devices	No integrated keyboard or TouchPad
	Supports USB- or Bluetooth-connected external keyboard and/or mouse
Power requirements	30-W AC adapter with localized cable plug support (AC adapter connects to the HP Slate 500 through the HP Slate Dock)
	Supports one 2-cell, 2.80-Ah (30-Wh) Lithium-polymer battery (non-replaceable)
Security	No support for security options
Operating system	Preinstalled: <ul style="list-style-type: none"> • Windows® 7 Enterprise • Windows 7 Home Premium 32 • Windows 7 Pro 32
	Restore media:
	OSDVD: <ul style="list-style-type: none"> • Windows 7 Home Premium 32 • Windows 7 Pro 32
	DRDVD: Windows 7

Category	Description
	Web-only support: Windows 7 Enterprise
Serviceability	No support for end-user replaceable parts

2 External component identification

Identifying the hardware

Components included with the Slate may vary by region and model. The illustrations in this chapter identify the standard features on most Slate models.

To see a list of hardware installed in the Slate:

1. Tap **Start > Control Panel**.
2. Tap **System and Security**, tap **System**, and then tap **Device Manager**.

You can also add hardware or modify Slate configurations using Device Manager.

Top edge



Item	Icon	Component	Description
(1)		Volume down button	Decreases speaker volume.
(2)		Volume up button	Increases speaker volume.
(3)		USB port	Connects optional USB devices. NOTE: To use an external optical disc drive (purchased separately) connected to the Slate, you must connect AC power separately to the external drive.
(4)		Ctrl+alt+del (Security) button	Performs the same action as pressing ctrl+alt+del on a computer keyboard.
(5)		Home button	Minimizes all open applications and displays the Windows desktop.

Bottom edge

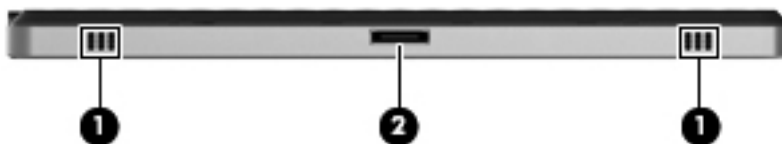

Item	Component	Description
(1)	Speakers (2)	Produce sound.
(2)	Power connector	Connects an AC adapter or an HP Slate Dock.

Right edge

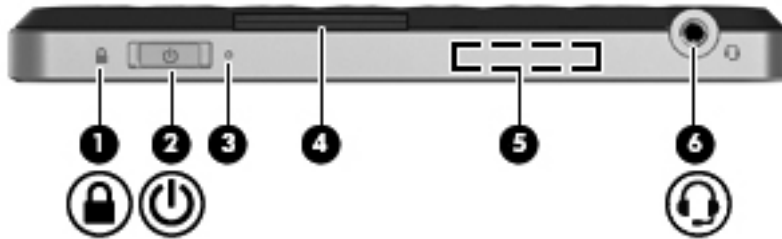

Item	Icon	Component	Description
(1)		PowerLock icon	<p>When the Slate is on, slide the power switch up to the lock position to lock the auto-rotate feature of the display.</p> <p>To turn off the auto-rotation feature:</p> <ol style="list-style-type: none"> 1. Tap the video icon in the notification area, at the far right of the taskbar, and then tap Graphics Properties, or tap and hold the desktop. 2. Tap Display Settings, tap to clear the Enable Rotation checkbox, and then tap OK.
(2)		Power switch	<ul style="list-style-type: none"> • When the Slate is off, slide the switch down to turn on the Slate. • When the Slate is on, briefly slide the switch down to initiate Sleep. • When the Slate is in the Sleep state, briefly slide the switch down to exit Sleep. • When the Slate is in Hibernation, briefly slide the switch down to exit Hibernation. <p>If the Slate has stopped responding and Windows shutdown procedures are ineffective, slide and hold the power switch down for at least five seconds to turn off the Slate.</p> <p>To learn more about your power settings, tap Start, tap Control Panel, tap System and Security, and then tap Power Options.</p>
(3)		Power light	<ul style="list-style-type: none"> • White: <ul style="list-style-type: none"> ◦ The Slate is on and connected to external power. ◦ The Slate is docked in the optional docking station, and the docking station is connected to external power. • Blinking: The Slate is in the Sleep state. • Off: The Slate is off or in Hibernation.
(4)		Label tray	Holds the serial number label and other labels.

Item	Icon	Component	Description
(5)		WLAN antennas	Sends and receives wireless signals to communicate with wireless local area networks (WLAN).
(6)		Audio-out (headphone)/Audio-in (microphone) combo jack	<p>Produces sound when connected to optional powered stereo speakers, headphones, earbuds, a headset, or line-in stereo audio connectors. Also connects an optional headset microphone.</p> <p>NOTE: When an audio component is connected to the jack, the Slate speakers are disabled.</p> <p>The audio component cable may have a 3-conductor or 4-conductor connector.</p>



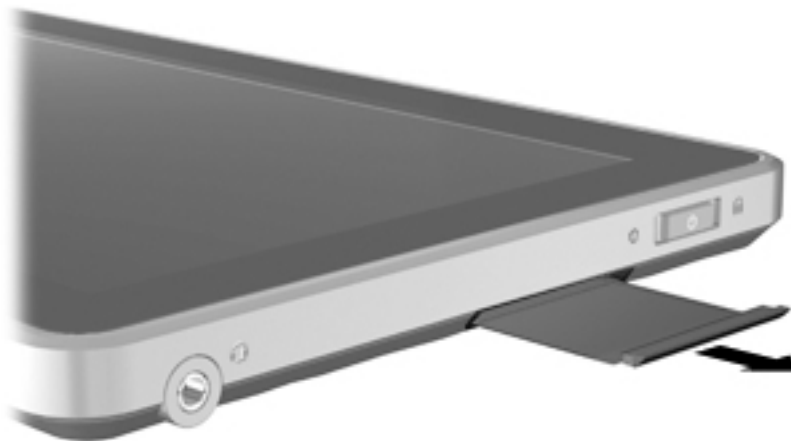

Opening the label tray

Pull the label tray out to view the serial number label, Microsoft Certificate of Authenticity label, regulatory label, Wireless certification label (select models only), SIM (subscriber identity module) label (select models only), and HP Broadband Module serial number label (select models only).



Left-edge



Item	Icon	Component	Description
(1)		SIM slot (select models only)	Supports a wireless subscriber identity module (SIM) (select models only).
(2)		SD Card Reader	Supports the following optional digital card formats: <ul style="list-style-type: none">Secure Digital High Capacity (SDHC) Memory Card (standard and large size)xD-Picture card
(3)		Keyboard button	Displays the default on-screen keyboard.
(4)		Internal microphone	Records sound.

Display



Item	Component	Description
(1)	Inward camera	Records video and captures still photographs.

Rear

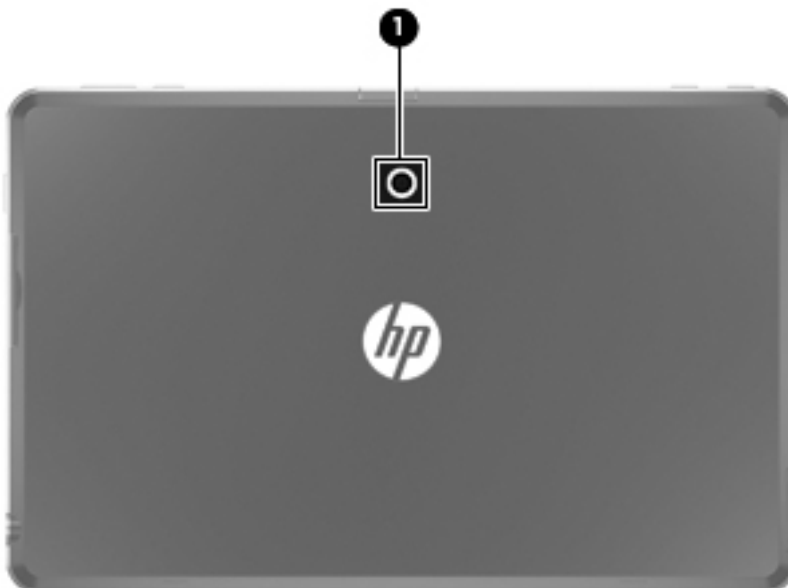

Item	Component	Description
(1)	Outward camera	Records video and captures still photographs.

3 Illustrated parts catalog

Identifying the labels

The labels affixed to the label tray of the Slate provide information you may need when you troubleshoot system problems or travel internationally with the Slate.

- Serial number label (part of the Master Regulatory label)—Provides important information including the following:

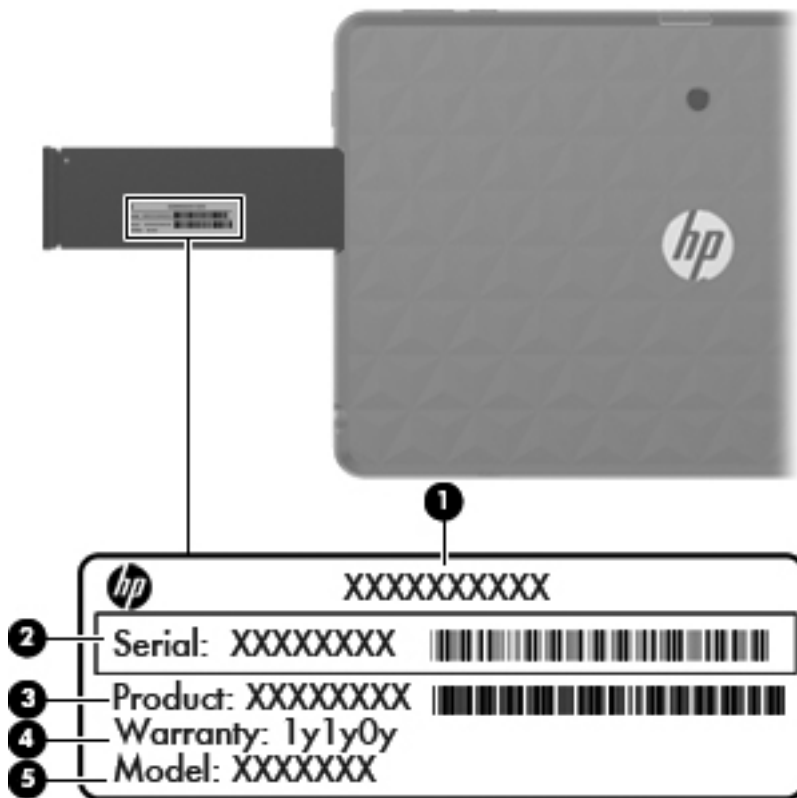

- Product name **(1)**. This is the product name affixed to the front of your Slate.
- Serial number **(2)**. This is an alphanumeric identifier that is unique to each product.
- Product number **(3)**. This is an alphanumeric identifier that provides specific information about the hardware components. The product number helps a service technician to determine what components and parts are needed.

- Warranty period **(4)**. This number describes the duration (in years) of the warranty period for this Slate.
- Model description (select models) **(5)**. This is an alphanumeric identifier that you use to locate documents, drivers, and support for your Slate.

Have this information available when you contact technical support. The serial number label is located inside the label tray of your Slate.

- Microsoft Certificate of Authenticity—Contains the Windows Product Key. You may need the Product Key to update or troubleshoot the operating system. This certificate is located inside the label tray.
- Regulatory label—Provides regulatory information about the Slate. The regulatory marks are located on the top or the bottom of the label tray.
- Wireless certification label(s)—Provide certification information about wireless devices, such as a wireless local area network (WLAN) device or a Bluetooth device, and the approval markings of some of the countries or regions in which the devices have been approved for use. You may need this information when traveling internationally. Wireless certification labels are affixed inside the label tray.

HP Slate 2 component spare part numbers



Item	Description	Spare part number
(1)	30-watt AC adapter	594913-001
(2)	Power cord (1.83-meter (6-foot), 3-pin):	
	For use in Argentina	490371-D01
	For use in Australia	490371-011
	For use in Brazil	490371-202
	For use in Denmark	490371-081
	For use in Europe	490371-021
	For use in India	490371-D61
	For use in Israel	490371-BB1
	For use in Italy	490371-061
	For use in Japan	490371-291
	For use in North America	490371-001
	For use in the People's Republic of China	490371-AA1
	For use in South Africa	490371-AR1
	For use in South Korea	490371-AD1
	For use in Switzerland	490371-111
	For use in Taiwan	490371-AB1
	For use in Thailand	490371-281

Item	Description	Spare part number
	For use in the United Kingdom and Singapore	490371-031
(3)	Black folio case	672413-001
(4)	HP Slate Dock	621229-001
(5)	HP Slate digital pen	611038-001
	RJ45-to-USB adapter cable (not illustrated)	539614-001
	HP Slate 2 (not illustrated):	
	HP Slate 2 for use in African-English countries and regions, equipped with 2-GB of system memory, 32-GB solid-state drive, and Windows 7 Professional	678562-001
	HP Slate 2 for use in African-English countries and regions, equipped with 2-GB of system memory, 32-GB solid-state drive, WWAN module. and Windows 7 Professional	678563-001
	HP Slate 2 for use in African-French-Arabic countries and regions, equipped with 2-GB of system memory, 32-GB solid-state drive, and Windows 7 Professional	678564-001
	HP Slate 2 for use in African-French-Arabic countries and regions, equipped with 2-GB of system memory, 32-GB solid-state drive, WWAN module. and Windows 7 Professional	678565-001
	HP Slate 2 for use in African-French countries and regions, equipped with 2-GB of system memory, 32-GB solid-state drive, and Windows 7 Professional	678560-001
	HP Slate 2 for use in African-French countries and regions, equipped with 2-GB of system memory, 32-GB solid-state drive, WWAN module. and Windows 7 Professional	678561-001
	HP Slate 2 for use in the Asia-Pacific countries and regions, equipped with 2-GB of system memory, 32-GB solid-state drive, and Windows 7 Home	679018-001
	HP Slate 2 for use in the Asia-Pacific countries and regions, equipped with 2-GB of system memory, 32-GB solid-state drive, WWAN module. and Windows 7 Home	679019-001
	HP Slate 2 for use in the Asia-Pacific countries and regions, equipped with 2-GB of system memory, 32-GB solid-state drive, and Windows 7 Professional	679020-001
	HP Slate 2 for use in the Asia-Pacific countries and regions, equipped with 2-GB of system memory, 32-GB solid-state drive, WWAN module. and Windows 7 Professional	679021-001
	HP Slate 2 for use in Brazil, equipped with 2-GB of system memory, 32-GB solid-state drive, and Windows 7 Professional	678576-001
	HP Slate 2 for use in Brazil, equipped with 2-GB of system memory, 32-GB solid-state drive, WWAN module. and Windows 7 Professional	678577-001
	HP Slate 2 for use in Bulgaria, equipped with 2-GB of system memory, 32-GB solid-state drive, and Windows 7 Professional	678554-001
	HP Slate 2 for use in Bulgaria, equipped with 2-GB of system memory, 32-GB solid-state drive, WWAN module. and Windows 7 Professional	678555-001
	HP Slate 2 for use in Croatia, Slovenia, Serbia, Montenegro, Bosnia and Herzegovina, equipped with 2-GB of system memory, 32-GB solid-state drive, and Windows 7 Professional	678540-001

Item	Description	Spare part number
	HP Slate 2 for use in Croatia, Slovenia, Serbia, Montenegro, Bosnia and Herzegovina, equipped with 2-GB of system memory, 32-GB solid-state drive, WWAN module. and Windows 7 Professional	678541-001
	HP Slate 2 for use in the Czech Republic and Slovakia, equipped with 2-GB of system memory, 32-GB solid-state drive, and Windows 7 Professional	678558-001
	HP Slate 2 for use in the Czech Republic and Slovakia, equipped with 2-GB of system memory, 32-GB solid-state drive, WWAN module. and Windows 7 Professional	678559-001
	HP Slate 2 for use in Europe, the Middle East, and Africa, equipped with 2-GB of system memory, 32-GB solid-state drive, and Windows 7 Professional	678544-001
	HP Slate 2 for use in Europe, the Middle East, and Africa, equipped with 2-GB of system memory, 32-GB solid-state drive, WWAN module. and Windows 7 Professional	678545-001
	HP Slate 2 for use in Europe-A2 countries and regions, equipped with 2-GB of system memory, 32-GB solid-state drive, and Windows 7 Professional	678550-001
	HP Slate 2 for use in Europe-A2 countries and regions, equipped with 2-GB of system memory, 32-GB solid-state drive, WWAN module. and Windows 7 Professional	678551-001
	HP Slate 2 for use in Europe-A5 countries and regions, equipped with 2-GB of system memory, 32-GB solid-state drive, and Windows 7 Professional	678556-001
	HP Slate 2 for use in Europe-A6 countries and regions, equipped with 2-GB of system memory, 32-GB solid-state drive, WWAN module. and Windows 7 Professional	678557-001
	HP Slate 2 for use in Greece, equipped with 2-GB of system memory, 32-GB solid-state drive, and Windows 7 Professional	678566-001
	HP Slate 2 for use in Greece, equipped with 2-GB of system memory, 32-GB solid-state drive, WWAN module. and Windows 7 Professional	678567-001
	HP Slate 2 for use in Hong Kong, equipped with 2-GB of system memory, 32-GB solid-state drive, and Windows 7 Home	679022-001
	HP Slate 2 for use in Hong Kong, equipped with 2-GB of system memory, 32-GB solid-state drive, WWAN module. and Windows 7 Home	679023-001
	HP Slate 2 for use in Hong Kong, equipped with 2-GB of system memory, 32-GB solid-state drive, and Windows 7 Professional	679024-001
	HP Slate 2 for use in Hong Kong, equipped with 2-GB of system memory, 32-GB solid-state drive, WWAN module. and Windows 7 Professional	679025-001
	HP Slate 2 for use in Hungary, equipped with 2-GB of system memory, 32-GB solid-state drive, and Windows 7 Professional	678552-001
	HP Slate 2 for use in Hungary, equipped with 2-GB of system memory, 32-GB solid-state drive, WWAN module. and Windows 7 Professional	678553-001
	HP Slate 2 for use in Iceland, equipped with 2-GB of system memory, 32-GB solid-state drive, and Windows 7 Professional	678542-001
	HP Slate 2 for use in Iceland, equipped with 2-GB of system memory, 32-GB solid-state drive, WWAN module. and Windows 7 Professional	678543-001
	HP Slate 2 for use in India, equipped with 2-GB of system memory, 32-GB solid-state drive, and Windows 7 Home	679026-001

Item	Description	Spare part number
	HP Slate 2 for use in India, equipped with 2-GB of system memory, 32-GB solid-state drive, WWAN module. and Windows 7 Home	679027-001
	HP Slate 2 for use in India, equipped with 2-GB of system memory, 32-GB solid-state drive, and Windows 7 Professional	679028-001
	HP Slate 2 for use in India, equipped with 2-GB of system memory, 32-GB solid-state drive, WWAN module. and Windows 7 Professional	679029-001
	HP Slate 2 for use in Indonesia, equipped with 2-GB of system memory, 32-GB solid-state drive, and Windows 7 Home	679030-001
	HP Slate 2 for use in Indonesia, equipped with 2-GB of system memory, 32-GB solid-state drive, WWAN module. and Windows 7 Home	679031-001
	HP Slate 2 for use in Indonesia, equipped with 2-GB of system memory, 32-GB solid-state drive, and Windows 7 Professional	679032-001
	HP Slate 2 for use in Indonesia, equipped with 2-GB of system memory, 32-GB solid-state drive, WWAN module. and Windows 7 Professional	679033-001
	HP Slate 2 for use in Israel, equipped with 2-GB of system memory, 32-GB solid-state drive, and Windows 7 Professional	678546-001
	HP Slate 2 for use in Israel, equipped with 2-GB of system memory, 32-GB solid-state drive, WWAN module. and Windows 7 Professional	678547-001
	HP Slate 2 for use in Japan, equipped with 2-GB of system memory, 32-GB solid-state drive, and Windows 7 Home	679035-001
	HP Slate 2 for use in Japan, equipped with 2-GB of system memory, 32-GB solid-state drive, WWAN module. and Windows 7 Home	679034-001
	HP Slate 2 for use in Japan, equipped with 2-GB of system memory, 32-GB solid-state drive, and Windows 7 Professional	679036-001
	HP Slate 2 for use in Japan, equipped with 2-GB of system memory, 32-GB solid-state drive, WWAN module. and Windows 7 Professional	679037-001
	HP Slate 2 for use in Japan, equipped with 2-GB of system memory, 32-GB solid-state drive, and Windows 7 Enterprise	679038-001
	HP Slate 2 for use in Japan, equipped with 2-GB of system memory, 32-GB solid-state drive, WWAN module. and Windows 7 Enterprise	679039-001
	HP Slate 2 for use in Japan (English), equipped with 2-GB of system memory, 32-GB solid-state drive, and Windows 7 Home	679041-001
	HP Slate 2 for use in Japan (English), equipped with 2-GB of system memory, 32-GB solid-state drive, WWAN module. and Windows 7 Home	679040-001
	HP Slate 2 for use in Japan (English), equipped with 2-GB of system memory, 32-GB solid-state drive, and Windows 7 Professional	679042-001
	HP Slate 2 for use in Japan (English), equipped with 2-GB of system memory, 32-GB solid-state drive, WWAN module. and Windows 7 Professional	679043-001
	HP Slate 2 for use in Latin America, equipped with 2-GB of system memory, 32-GB solid-state drive, and Windows 7 Home	675914-001

Item	Description	Spare part number
	HP Slate 2 for use in Latin America, equipped with 2-GB of system memory, 32-GB solid-state drive, WWAN module, and Windows 7 Home	675915-001
	HP Slate 2 for use in Latin America, equipped with 2-GB of system memory, 32-GB solid-state drive, and Windows 7 Professional	679215-001
	HP Slate 2 for use in Latin America, equipped with 2-GB of system memory, 32-GB solid-state drive, WWAN module, and Windows 7 Professional	679216-001
	HP Slate 2 for use in Latin America, equipped with 2-GB of system memory, 32-GB solid-state drive, and Windows 7 Enterprise	675912-001
	HP Slate 2 for use in Latin America, equipped with 2-GB of system memory, 32-GB solid-state drive, WWAN module, and Windows 7 Enterprise	675913-001
	HP Slate 2 for use in the People's Republic of China (Chinese), equipped with 2-GB of system memory, 32-GB solid-state drive, and Windows 7 Home	679054-001
	HP Slate 2 for use in the People's Republic of China (Chinese), equipped with 2-GB of system memory, 32-GB solid-state drive, WWAN module. and Windows 7 Home	679055-001
	HP Slate 2 for use in the People's Republic of China (Chinese), equipped with 2-GB of system memory, 32-GB solid-state drive, and Windows 7 Professional	679052-001
	HP Slate 2 for use in the People's Republic of China (Chinese), equipped with 2-GB of system memory, 32-GB solid-state drive, WWAN module. and Windows 7 Professional	679053-001
	HP Slate 2 for use in the People's Republic of China (Chinese), equipped with 2-GB of system memory, 32-GB solid-state drive, and Windows 7 Enterprise	679056-001
	HP Slate 2 for use in the People's Republic of China (Chinese), equipped with 2-GB of system memory, 32-GB solid-state drive, WWAN module. and Windows 7 Enterprise	679057-001
	HP Slate 2 for use in the People's Republic of China (Chinese and English), equipped with 2-GB of system memory, 32-GB solid-state drive, and Windows 7 Home	679050-001
	HP Slate 2 for use in the People's Republic of China (Chinese and English), equipped with 2-GB of system memory, 32-GB solid-state drive, WWAN module. and Windows 7 Home	679051-001
	HP Slate 2 for use in the People's Republic of China (Chinese and English), equipped with 2-GB of system memory, 32-GB solid-state drive, and Windows 7 Professional	679048-001
	HP Slate 2 for use in the People's Republic of China (Chinese and English), equipped with 2-GB of system memory, 32-GB solid-state drive, WWAN module. and Windows 7 Professional	679049-001
	HP Slate 2 for use in Russia, equipped with 2-GB of system memory, 32-GB solid-state drive, and Windows 7 Professional	678574-001
	HP Slate 2 for use in Russia, equipped with 2-GB of system memory, 32-GB solid-state drive, WWAN module. and Windows 7 Professional	678575-001
	HP Slate 2 for use in Saudi Arabia, equipped with 2-GB of system memory, 32-GB solid-state drive, and Windows 7 Professional	678548-001
	HP Slate 2 for use in Saudi Arabia, equipped with 2-GB of system memory, 32-GB solid-state drive, WWAN module. and Windows 7 Professional	678549-001

Item	Description	Spare part number
	HP Slate 2 for use in Singapore, equipped with 2-GB of system memory, 32-GB solid-state drive, and Windows 7 Home	679058-001
	HP Slate 2 for use in Singapore, equipped with 2-GB of system memory, 32-GB solid-state drive, WWAN module. and Windows 7 Home	679059-001
	HP Slate 2 for use in Singapore, equipped with 2-GB of system memory, 32-GB solid-state drive, and Windows 7 Professional	679060-001
	HP Slate 2 for use in Singapore, equipped with 2-GB of system memory, 32-GB solid-state drive, WWAN module. and Windows 7 Professional	679061-001
	HP Slate 2 for use in South Korea, equipped with 2-GB of system memory, 32-GB solid-state drive, WWAN module. and Windows 7 Home	679044-001
	HP Slate 2 for use in South Korea, equipped with 2-GB of system memory, 32-GB solid-state drive, and Windows 7 Home	679045-001
	HP Slate 2 for use in South Korea, equipped with 2-GB of system memory, 32-GB solid-state drive, and Windows 7 Professional	679046-001
	HP Slate 2 for use in South Korea, equipped with 2-GB of system memory, 32-GB solid-state drive, WWAN module. and Windows 7 Professional	679047-001
	HP Slate 2 for use in Taiwan, equipped with 2-GB of system memory, 32-GB solid-state drive, and Windows 7 Home	679064-001
	HP Slate 2 for use in Taiwan, equipped with 2-GB of system memory, 32-GB solid-state drive, WWAN module. and Windows 7 Home	679065-001
	HP Slate 2 for use in Taiwan, equipped with 2-GB of system memory, 32-GB solid-state drive, and Windows 7 Professional	679062-001
	HP Slate 2 for use in Taiwan, equipped with 2-GB of system memory, 32-GB solid-state drive, WWAN module. and Windows 7 Professional	679063-001
	HP Slate 2 for use in Thailand, equipped with 2-GB of system memory, 32-GB solid-state drive, and Windows 7 Home	679066-001
	HP Slate 2 for use in Thailand, equipped with 2-GB of system memory, 32-GB solid-state drive, WWAN module. and Windows 7 Home	679067-001
	HP Slate 2 for use in Thailand, equipped with 2-GB of system memory, 32-GB solid-state drive, and Windows 7 Professional	679068-001
	HP Slate 2 for use in Thailand, equipped with 2-GB of system memory, 32-GB solid-state drive, WWAN module. and Windows 7 Professional	679069-001
	HP Slate 2 for use in Turkey, equipped with 2-GB of system memory, 32-GB solid-state drive, and Windows 7 Professional	678572-001
	HP Slate 2 for use in Turkey, equipped with 2-GB of system memory, 32-GB solid-state drive, WWAN module. and Windows 7 Professional	678573-001

4 Removal and replacement procedures

Preliminary replacement requirements

Service considerations

The following sections include some of the considerations that you must keep in mind during disassembly and assembly procedures.



NOTE: As you remove each subassembly from the Slate, place the subassembly away from the work area to prevent damage.

Plastic parts



CAUTION: Using excessive force during disassembly and reassembly can damage plastic parts. Use care when handling the plastic parts. Apply pressure only at the points designated in the maintenance instructions.

Cables and connectors



CAUTION: When servicing the Slate, be sure that cables are placed in their proper locations during the reassembly process. Improper cable placement can damage the Slate.

Cables must be handled with extreme care to avoid damage. Apply only the tension required to unseat or seat the cables during removal and insertion. Handle cables by the connector whenever possible. In all cases, avoid bending, twisting, or tearing cables. Be sure that cables are routed in such a way that they cannot be caught or snagged by parts being removed or replaced. Handle flex cables with extreme care; these cables tear easily.

Drive handling

⚠ CAUTION: The solid-state drive inside the Slate is a fragile component that must be handled with care. To prevent damage to the Slate, damage to the solid-state drive, or loss of information, observe these precautions:

Before handling the Slate, be sure that you are discharged of static electricity.

Avoid dropping the Slate from any height onto any surface.

Avoid exposing the Slate to temperature extremes or liquids.

If the Slate must be mailed, place it in a bubble pack mailer or other suitable form of protective packaging and label the package "FRAGILE."

Grounding guidelines

Electrostatic discharge damage

Electronic components are sensitive to electrostatic discharge (ESD). Circuitry design and structure determine the degree of sensitivity. Networks built into many integrated circuits provide some protection, but in many cases, ESD contains enough power to alter device parameters or melt silicon junctions.

A discharge of static electricity from a finger or other conductor can destroy static-sensitive devices or microcircuitry. Even if the spark is neither felt nor heard, damage may have occurred.

An electronic device exposed to ESD may not be affected at all and can work perfectly throughout a normal cycle. Or the device may function normally for a while, then degrade in the internal layers, reducing its life expectancy.

⚠ CAUTION: To prevent damage to the Slate when you are removing or installing internal components, observe these precautions:

Keep components in their electrostatic-safe containers until you are ready to install them.

Before touching an electronic component, discharge static electricity by using the guidelines described in this section.

Avoid touching pins, leads, and circuitry. Handle electronic components as little as possible.

If you remove a component, place it in an electrostatic-safe container.

The following table shows how humidity affects the electrostatic voltage levels generated by different activities.

⚠ CAUTION: A product can be degraded by as little as 700 V.

Typical electrostatic voltage levels			
Event	Relative humidity		
	10%	40%	55%
Walking across carpet	35,000 V	15,000 V	7,500 V
Walking across vinyl floor	12,000 V	5,000 V	3,000 V
Motions of bench worker	6,000 V	800 V	400 V
Removing DIPS from plastic tube	2,000 V	700 V	400 V
Removing DIPS from vinyl tray	11,500 V	4,000 V	2,000 V
Removing DIPS from Styrofoam	14,500 V	5,000 V	3,500 V
Removing bubble pack from PCB	26,500 V	20,000 V	7,000 V
Packing PCBs in foam-lined box	21,000 V	11,000 V	5,000 V

Packaging and transporting guidelines

Follow these grounding guidelines when packaging and transporting equipment:

- To avoid hand contact, transport products in static-safe tubes, bags, or boxes.
- Protect ESD-sensitive parts and assemblies with conductive or approved containers or packaging.
- Keep ESD-sensitive parts in their containers until the parts arrive at static-free workstations.
- Place items on a grounded surface before removing items from their containers.
- Always be properly grounded when touching a component or assembly.
- Store reusable ESD-sensitive parts from assemblies in protective packaging or nonconductive foam.
- Use transporters and conveyors made of antistatic belts and roller bushings. Be sure that mechanized equipment used for moving materials is wired to ground and that proper materials are selected to avoid static charging. When grounding is not possible, use an ionizer to dissipate electric charges.

Workstation guidelines

Follow these grounding workstation guidelines:

- Cover the workstation with approved static-shielding material.
- Use a wrist strap connected to a properly grounded work surface and use properly grounded tools and equipment.
- Use conductive field service tools, such as cutters, screwdrivers, and vacuums.
- When fixtures must directly contact dissipative surfaces, use fixtures made only of static-safe materials.
- Keep the work area free of nonconductive materials, such as ordinary plastic assembly aids and Styrofoam.
- Handle ESD-sensitive components, parts, and assemblies by the case or PCM laminate. Handle these items only at static-free workstations.
- Avoid contact with pins, leads, or circuitry.
- Turn off power and input signals before inserting or removing connectors or test equipment.

Equipment guidelines

Grounding equipment must include either a wrist strap or a foot strap at a grounded workstation.

- When seated, wear a wrist strap connected to a grounded system. Wrist straps are flexible straps with a minimum of one megohm $\pm 10\%$ resistance in the ground cords. To provide proper ground, wear a strap snugly against the skin at all times. On grounded mats with banana-plug connectors, use alligator clips to connect a wrist strap.
- When standing, use foot straps and a grounded floor mat. Foot straps (heel, toe, or boot straps) can be used at standing workstations and are compatible with most types of shoes or boots. On conductive floors or dissipative floor mats, use foot straps on both feet with a minimum of one megohm resistance between the operator and ground. To be effective, the conductive must be worn in contact with the skin.

The following grounding equipment is recommended to prevent electrostatic damage:

- Antistatic tape
- Antistatic smocks, aprons, and sleeve protectors
- Conductive bins and other assembly or soldering aids
- Nonconductive foam
- Conductive tabletop workstations with ground cords of one megohm resistance
- Static-dissipative tables or floor mats with hard ties to the ground
- Field service kits
- Static awareness labels
- Material-handling packages
- Nonconductive plastic bags, tubes, or boxes
- Metal tote boxes
- Electrostatic voltage levels and protective materials

The following table lists the shielding protection provided by antistatic bags and floor mats.

Material	Use	Voltage protection level
Antistatic plastics	Bags	1,500 V
Carbon-loaded plastic	Floor mats	7,500 V
Metallized laminate	Floor mats	5,000 V

Component replacement procedures

Identifying the labels

The labels affixed to the label tray of the Slate provide information you may need when you troubleshoot system problems or travel internationally with the Slate.

- Serial number label (part of the Master Regulatory label)—Provides important information including the following:

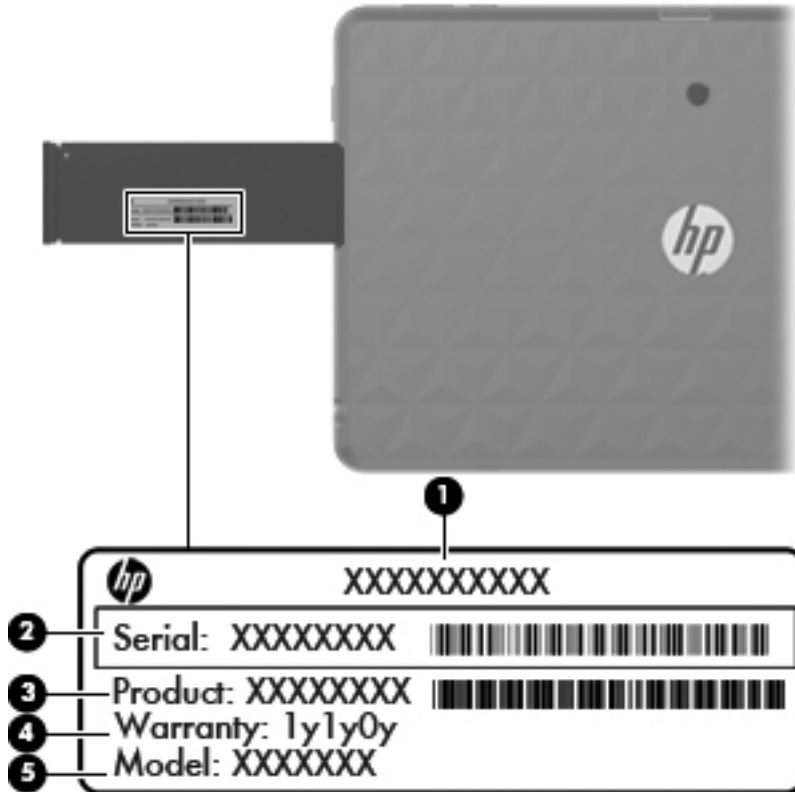

- Product name **(1)**. This is the product name affixed to the front of your Slate.
- Serial number **(2)**. This is an alphanumeric identifier that is unique to each product.
- Product number **(3)**. This is an alphanumeric identifier that provides specific information about the hardware components. The product number helps a service technician to determine what components and parts are needed.
- Warranty period **(4)**. This number describes the duration (in years) of the warranty period for this Slate.
- Model description (select models) **(5)**. This is an alphanumeric identifier that you use to locate documents, drivers, and support for your Slate.

Have this information available when you contact technical support. The serial number label is located inside the label tray of your Slate.

- Microsoft Certificate of Authenticity—Contains the Windows Product Key. You may need the Product Key to update or troubleshoot the operating system. This certificate is located inside the label tray.
- Regulatory label—Provides regulatory information about the Slate. The regulatory marks are located on the top or the bottom of the label tray.
- Wireless certification label(s)—Provide certification information about wireless devices, such as a wireless local area network (WLAN) device or a Bluetooth device, and the approval markings of some of the countries or regions in which the devices have been approved for use. You may need this information when traveling internationally. Wireless certification labels are affixed inside the label tray.

Digital pen

Description	Spare part number
Digital pen	611038-001

To insert the battery into the pen:

1. Unscrew the cap from the pen.
2. Insert the battery **(1)** in the pen.
3. Replace the cap **(2)** on the pen.
4. Turn the cap in a clockwise direction **(3)** to tighten it.

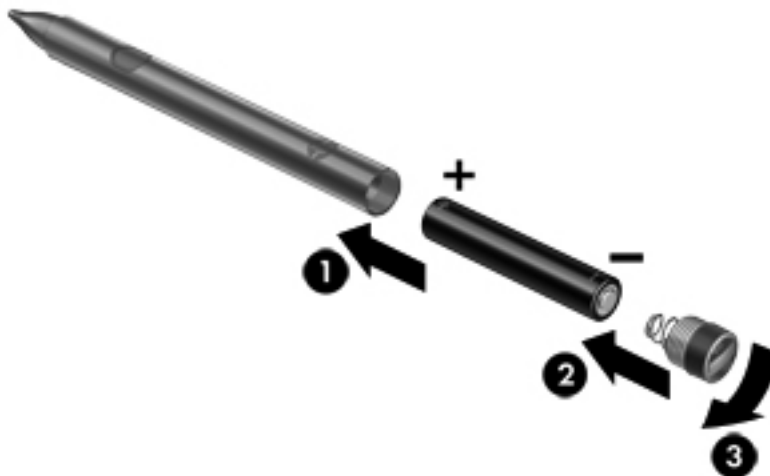

HP Slate Dock

Description	Spare part number
HP Slate Dock	621229-001

To dock the HP Slate to the HP Slate Dock:

1. Align the docking connector on the HP Slate Dock base with the power connector on the bottom edge of the HP Slate, and then lower the Slate onto the dock.



2. Plug the AC adapter into the power connector on the back of the HP Slate Dock.
3. Plug the power cord into the AC adapter.
4. Plug the other end of the power cord into an AC outlet.

Reverse this procedure to undock the HP Slate from the HP Slate Dock and disconnect the AC adapter and power cord.

5 BIOS Setup

Starting BIOS Setup

BIOS Setup is a ROM-based information and customization utility that can be used even when your Windows operating system is not working.

The utility reports information about the Slate and provides settings for startup, security, and other preferences.

To start BIOS Setup:

 **NOTE:** An external keyboard may be connected to the USB port to perform these steps.

1. Open the Startup Menu by turning on or restarting the Slate, and then, while the hyphen is displayed in the upper-left corner of the screen, repeatedly pressing the Volume down button (-) on the Slate or **f10** on an external keyboard.
2. Press the Volume down button (-) on the Slate to advance to BIOS Setup, and then select it by pressing the Home button on the Slate or **enter** on an external keyboard.

Using BIOS Setup

Changing the language of BIOS Setup

The following procedure explains how to change the language of BIOS Setup. If BIOS Setup is not already running, begin at step 1. If BIOS Setup is already running, begin at step 3.

 **NOTE:** An external keyboard may be connected to the USB port to perform these steps.

1. Open the Startup Menu by turning on or restarting the Slate, and then, while the hyphen is displayed in the upper-left corner of the screen, repeatedly pressing the Volume down button (-) on the Slate or **f10** on an external keyboard.
2. Press the Volume down button (-) on the Slate, or use the arrow keys on an external keyboard to advance to **BIOS Setup**, and then select it by pressing the Home button on the Slate or **enter** on an external keyboard.
3. Press the Volume up button (+) or the Volume down button (-) on the Slate, or use the arrow keys on an external keyboard to select **System Configuration > Language**, and then press the Home button on the Slate or **enter** on an external keyboard.

4. Press the Volume up button (+) or Volume down button (-) on the Slate or the arrow keys on an external keyboard to select a language, and then press the Home button on the Slate or **enter** on an external keyboard.
5. To save your changes and exit BIOS Setup, press the Ctrl+alt+del button on the top edge of the Slate, or use the arrow keys on an external keyboard to select **Exit > Exit Saving Changes**. Then press the Home button on the Slate or **enter** on an external keyboard.

Your change goes into effect immediately.

Navigating and selecting in BIOS Setup

Because BIOS Setup is not Windows based, it does not support the touch screen. Navigation and selection are by keystroke.

 **NOTE:** An external keyboard may be connected to the USB port to perform these steps.

- To choose a menu or a menu item, press the Home button on the Slate, or use the arrow keys on an external keyboard.
- To navigate between menus in BIOS Setup, press the Home button and the Volume up (+) or Volume down (-) button simultaneously, or use the arrow keys on an external keyboard.
- To choose an item in a list or to toggle a field, for example an Enable/Disable field, use either the Home button, the Volume up button, or the Volume down button on the Slate, or the arrow keys on an external keyboard.
- To select an item, press the Home button on the Slate or the **enter** key on an external keyboard.
- To close a text box or return to the menu display, press the Ctrl+alt+del (Security) button on the top edge of the Slate or **esc** on an external keyboard.
- Information about navigation keys is displayed at the bottom of the screen. To display additional navigation and selection information while BIOS Setup is open, press **f1** on an external keyboard.

Displaying system information

The following procedure explains how to display system information in BIOS Setup. If BIOS Setup is not open, begin at step 1. If BIOS Setup is open, begin at step 3.

 **NOTE:** An external keyboard may be connected to the USB port to perform these steps.

1. Open the Startup Menu by turning on or restarting the Slate, and then, while the hyphen is displayed in the upper-left corner of the screen, repeatedly pressing the Volume down button (-) on the Slate or **f10** on an external keyboard.
2. Press the Volume down button (-) on the Slate, or use the arrow keys on an external keyboard, to advance to **BIOS Setup**, and then select it by pressing the Home button on the Slate or **enter** on an external keyboard.

3. If BIOS Setup does not open with the system information displayed, press the Home button and the Volume up button (+) on the Slate simultaneously, or use the arrow keys on an external keyboard, to select the **Main** menu.

When the Main menu is selected, system information is displayed.

4. To exit BIOS Setup without changing any settings, press the Ctrl+alt+del (Security) button on the top edge of the Slate or the arrow keys on an external keyboard to select **Exit > Exit Discarding Changes**. Then press the Home button on the Slate or the **enter** key on an external keyboard.

Restoring factory settings in BIOS Setup

The following procedure explains how to restore the BIOS Setup factory settings. If BIOS Setup is not already running, begin at step 1. If BIOS Setup is already running, begin at step 3.

 **NOTE:** An external keyboard may be connected to the USB port to perform these steps.

1. Open the Startup Menu by turning on or restarting the Slate, and then, while the hyphen is displayed in the upper-left corner of the screen, repeatedly pressing the Volume down button (-) on the Slate or **f10** on an external keyboard.
2. Press the Volume down button (-) on the Slate, or use the arrow keys on an external keyboard, to advance to **BIOS Setup**, and then select it by pressing the Home button on the Slate or **enter** on an external keyboard.
3. Press the Home button and the Volume up button (+) on the Slate simultaneously or the arrow keys on an external keyboard to select **Exit > Load Setup Defaults**. Then press the Home button on the Slate or the **enter** key on an external keyboard.
4. When the Setup Confirmation is displayed, press the Home button on the Slate or the **enter** key on an external keyboard.
5. To save your changes and exit BIOS Setup, press the Ctrl+alt+del (Security) button on the top edge of the Slate, or use the arrow keys on an external keyboard, to select **Exit > Exit Saving Changes**. Then press the Home button on the Slate or the **enter** key on an external keyboard.

The BIOS Setup factory settings go into effect when the Slate restarts.

 **NOTE:** Your password, security, and language settings are not changed when you restore the factory default settings.

Exiting BIOS Setup

You can exit BIOS Setup with or without saving changes.



NOTE: An external keyboard may be connected to the USB port to perform these steps.

- To exit BIOS Setup and save your changes from the current session:
Press the Ctrl+alt+del (Security) button on the top edge of the Slate, or use the arrow keys on an external keyboard, to select **Exit > Exit Saving Changes**. Then press the Home button on the Slate or the [enter](#) key on an external keyboard.
- To exit BIOS Setup without saving your changes from the current session:
Press the Ctrl+alt+del (Security) button on the top edge of the Slate, or use the arrow keys on an external keyboard, to select **Exit > Exit Discarding Changes**. Then press the Home button on the Slate or the [enter](#) key on an external keyboard.

After either choice, the Slate restarts in Windows.

Updating the BIOS

Updated versions of the software provided with your Slate may be available on the HP Web site.

Most BIOS updates on the HP Web site are packaged in compressed files called SoftPaqs.

Some download packages contain a file named Readme.txt, which contains information regarding installing and troubleshooting the file.

Determining the BIOS version

To determine whether available BIOS updates contain later BIOS versions than those currently installed on the Slate, you need to know the version of the system BIOS currently installed.

BIOS version information (also known as *ROM date* and *System BIOS*) can be displayed by opening BIOS Setup.

To display the BIOS information:



NOTE: An external keyboard may be connected to the USB port to perform these steps.

1. Open the Startup Menu by turning on or restarting the Slate, and then, while the hyphen is displayed in the upper-left corner of the screen, repeatedly pressing the Volume down button (-) on the Slate or [f10](#) on an external keyboard.
2. Press the Volume down button (-) on the Slate, or use the arrow keys on an external keyboard, to advance to BIOS Setup, and then select it by pressing the Home button on the Slate or [enter](#) on an external keyboard.

3. If BIOS Setup does not open with the system information displayed, press the Home button and the Volume up button (+) on the Slate simultaneously, or use the arrow keys on an external keyboard, to select the **Main** menu.

When the Main menu is selected, BIOS and other system information is displayed.

4. To exit BIOS Setup without saving your changes from the current session:

Press the Ctrl+alt+del (Security) button on the top edge of the Slate, or use the arrow keys on an external keyboard, to select **Exit > Exit Discarding Changes**. Then press the Home button on the Slate or the [enter](#) key on an external keyboard.

Downloading a BIOS update

 **CAUTION:** To reduce the risk of damage to the Slate or an unsuccessful installation, download and install a BIOS update only when the Slate is connected to reliable external power using the AC adapter. Do not download or install a BIOS update while the Slate is running on battery power, docked in an optional docking device, or connected to an optional power source. During the download and installation, follow these instructions:

Do not disconnect power from the Slate by unplugging the power cord from the AC outlet.

Do not shut down the Slate or initiate Sleep or Hibernation.

Do not insert, remove, connect, or disconnect any device, cable, or cord.

To download a BIOS update:

1. Access the updates on the HP Web site at <http://www.hp.com>.
2. Follow the on-screen instructions to identify your Slate and access the BIOS update you want to download.
3. At the download area, follow these steps:
 - a. Identify the BIOS update that is later than the BIOS version currently installed on your Slate. Make a note of the date, name, or other identifier. You may need this information to locate the update later, after it has been downloaded to your hard drive.
 - b. Follow the instructions on the screen to download your selection to the hard drive.

Make a note of the path to the location on your hard drive where the BIOS update is to be downloaded. You will need to access this path when you are ready to install the update.

 **NOTE:** If you connect your Slate to a network, consult the network administrator before installing any software updates, especially system BIOS updates.

BIOS installation procedures vary. Follow any instructions that are displayed on the screen after the download is complete. If no instructions are displayed, follow these steps:

1. Open Windows Explorer by tapping **Start > Computer**.
2. Double-tap your hard drive designation. The hard drive designation is typically Local Disk (C:).

3. Using the hard drive path you recorded earlier, open the folder on your hard drive that contains the update.
4. Double-tap the file that has an .exe extension (for example, *filename.exe*).
The BIOS installation begins.
5. Complete the installation by following the instructions on the screen.



NOTE: After a message on the screen reports a successful installation, you can delete the downloaded file from your hard drive.

BIOS Setup Menu

The tables in this section provide an overview of the BIOS Setup menu options.

 **NOTE:** Some of the BIOS Setup menu items listed in this chapter may not be supported by your Slate

Main menu

Select	To do this
System information	<ul style="list-style-type: none">• View and change the system time and date.• View identification information about the Slate.• View specification information about the processor, memory size, and system BIOS.

Diagnostics menu

Select	To do this
Primary Hard Disk Self Test	Run a quick or comprehensive self-test on the hard drive.
Memory Test	Run a diagnostic test on the system memory.

System Configuration menu

Select	To do this
Language	Change the display language for BIOS Setup.
Virtualization Technology	Enable or disable. HP recommends that this feature remain disabled unless specialized applications are being used.
USB Legacy	Enable or disable a USB keyboard, disk, or drive to be used in BIOS Setup.
Processor deeper power saving states	Enable or disable.
Boot Options	<ul style="list-style-type: none">• POST HotKey Delay—Select 0, 5, 10, 15, or 20 seconds to allow more time to press a hotkey to enter BIOS Setup when the Slate restarts.• Boot Order options —Select the order in which the Slate searches for a boot disk.

6 Specifications

Operating environment

The operating environment information in the following table may be helpful if the Slate will be used in or transported to in extreme environments.

	Metric	U.S.
Dimensions		
Depth	23.39 cm	9.21 in
Width	14.98 cm	5.90 in
Height	1.50 cm	0.61 in
Weight		
	0.70 kg	1.53 lbs
Temperature		
Operating	5°C to 35°C	41°F to 95°F
Nonoperating	-20°C to 65°C	-4°F to 149°F
Relative humidity (noncondensing)		
Operating	10% to 90%	
Nonoperating	5% to 90%	
Maximum altitude (unpressurized)		
Operating	-15 m to 3,048 m	-50 ft to 10,000 ft
Nonoperating	-15 m to 12,192 m	-50 ft to 40,000 ft

Input power

The power information in this section may be helpful if the Slate will be used internationally.

The Slate operates on DC power, which can be supplied by an AC or a DC power source.

The AC power source must be rated at 100–240 V, 50–60 Hz.

Although the Slate can be powered from a standalone DC power source, it should be powered only with an AC adapter or a DC power source supplied and approved by HP for use with this Slate.

The Slate is capable of accepting DC power within the following specifications.

Input power	Rating
Operating voltage and current	19 V dc @ 1.58 A - 30 W

 **NOTE:** This product is designed for IT power systems in Norway with phase-to-phase voltage not exceeding 240 V rms.

 **NOTE:** The Slate operating voltage and current can be found on the system regulatory label, located inside the label tray on the right edge of the Slate.

7 Backup and recovery

To protect your information, back up your files and folders. In case of system failure, you can use the backup files to restore your Slate.

Using Windows Backup and Restore

To create a backup using Windows Backup and Restore, follow these steps:

 **NOTE:** Be sure that the Slate is connected to AC power before you start the backup process.

 **NOTE:** The backup process may take over an hour, depending on file size and the speed of the Slate.

1. Tap **Start**, tap **All Programs**, tap **Maintenance**, and then tap **Backup and Restore**.
2. Follow the on-screen instructions to set up and create a backup.

 **NOTE:** Windows includes the User Account Control feature to improve the security of your Slate. You may be prompted for your permission or password for tasks such as installing software, running utilities, or changing Windows settings. Refer to Help and Support for more information.

Using system restore points

 **NOTE:** “Hard drive” references in this chapter refer to the flash memory drive.

When you back up your system, you are creating a system restore point. A system restore point allows you to save and name a snapshot of your hard drive at a specific point in time. You can then revert back to that point if you want to reverse subsequent changes made to your system.

 **NOTE:** Recovering to an earlier restore point does not affect data files saved or e-mails created since the last restore point.

You also can create additional restore points to provide increased protection for your system files and settings.

When to create restore points

- Before you add or extensively modify software or hardware.
- Periodically, whenever the system is performing optimally.



NOTE: If you revert to a restore point and then change your mind, you can reverse the restoration.

Creating a system restore point

1. Tap **Start**, tap **Control Panel**, tap **System and Security**, and then tap **System**.
2. In the left pane, tap **System protection**.
3. Tap the **System Protection** tab.
4. Under **Protection Settings**, select the disk for which you want to create a restore point.
5. Tap **Create**.
6. Follow the on-screen instructions.

Restoring to a previous date and time

To revert to a restore point (created at a previous date and time) when the Slate was functioning optimally, follow these steps:

1. Tap **Start**, tap **Control Panel**, tap **System and Security**, and then tap **System**.
2. In the left pane, tap **System protection**.
3. Tap the **System Protection** tab.
4. Tap **System Restore**.
5. Follow the on-screen instructions.

8 Power cord set requirements

The wide-range input feature of the computer permits it to operate from any line voltage from 100 to 120 volts AC, or from 220 to 240 volts AC.

The 3-conductor power cord set included with the computer meets the requirements for use in the country or region where the equipment is purchased.

Power cord sets for use in other countries and regions must meet the requirements of the country or region where the computer is used.

Requirements for all countries

The following requirements are applicable to all countries and regions:

- The length of the power cord set must be at least **1.5 m** (5.0 ft) and no more than **2.0 m** (6.5 ft).
- All power cord sets must be approved by an acceptable accredited agency responsible for evaluation in the country or region where the power cord set will be used.
- The power cord sets must have a minimum current capacity of 10 A and a nominal voltage rating of 125 or 250 V ac, as required by the power system of each country or region.
- The appliance coupler must meet the mechanical configuration of an EN 60 320/IEC 320 Standard Sheet C13 connector for mating with the appliance inlet on the back of the computer.

Requirements for specific countries and regions

Country/region	Accredited agency	Applicable note number
Argentina	IRAM	1
Australia	SAA	1
Austria	OVE	1
Belgium	CEBEC	1
Brazil	ABNT	1
Canada	CSA	2
Chile	IMQ	1
Denmark	DEMKO	1
Finland	FIMKO	1
France	UTE	1
Germany	VDE	1
India	ISI	1
Israel	SII	1
Italy	IMQ	1
Japan	JIS	3
The Netherlands	KEMA	1
New Zealand	SANZ	1
Norway	NEMKO	1
The People's Republic of China	CCC	4
Saudi Arabia	SASO	7
Singapore	PSB	1
South Africa	SABS	1
South Korea	KTL	5
Sweden	SEMKO	1
Switzerland	SEV	1
Taiwan	BSMI	6
Thailand	TISI	1
The United Kingdom	ASTA	1

Country/region	Accredited agency	Applicable note number
The United States	UL	2
<ol style="list-style-type: none"> 1. The flexible cord must be Type HO5VV-F, 3-conductor, 0.75-mm² conductor size. Power cord set fittings (appliance coupler and wall plug) must bear the certification mark of the agency responsible for evaluation in the country or region where it will be used. 2. The flexible cord must be Type SVT/SJT or equivalent, No. 18 AWG, 3-conductor. The wall plug must be a two-pole grounding type with a NEMA 5-15P (15 A, 125 V) or NEMA 6-15P (15 A, 250 V ac) configuration. CSA or C-UL mark. UL file number must be on each element. 3. The appliance coupler, flexible cord, and wall plug must bear a "T" mark and registration number in accordance with the Japanese Dentori Law. The flexible cord must be Type VCTF, 3-conductor, 0.75-mm² or 1.25-mm² conductor size. The wall plug must be a two-pole grounding type with a Japanese Industrial Standard C8303 (7 A, 125 V ac) configuration. 4. The flexible cord must be Type RVV, 3-conductor, 0.75-mm² conductor size. Power cord set fittings (appliance coupler and wall plug) must bear the CCC certification mark. 5. The flexible cord must be Type HO5VV-F 3X0.75-mm² conductor size. KTL logo and individual approval number must be on each element. Corset approval number and logo must be printed on a flag label. 6. The flexible cord must be Type HVCTF 3x1.25-mm² conductor size. Power cord set fittings (appliance coupler, cable, and wall plug) must bear the BSMI certification mark. 7. For 127 V ac, the flexible cord must be Type SVT or SJT 3 x 18 AWG, with plug NEMA 5-15P (15 A, 125 V ac), with UL and CSA or C-UL marks. For 240 V ac, the flexible cord must be Type HO5VV-F 3x0.75-/1.00-mm² conductor size, with plug BS 1363/A with BSI or ASTA marks. 		

9 Recycling

When a non-rechargeable or rechargeable battery has reached the end of its useful life, do not dispose of the battery in general household waste. Follow the local laws and regulations in your area for battery disposal.

HP encourages customers to recycle used electronic hardware, HP original print cartridges, and rechargeable batteries. For more information about recycling programs, see the HP Web site at <http://www.hp.com/recycle>.

Index

A

- AC adapter
 - illustrated 12
 - spare part number 12
- antenna, locations 7
- audio, product description 1
- audio-in jack 7
- audio-out jack 7

B

- bottom-edge components 5
- buttons
 - ctrl+alt+del 5
 - home 5
 - keyboard 8
 - volume down 5
 - volume up 5

C

- cables, service considerations 18
- camera, inward 9
- camera, outward 9
- chipset, product description 1
- components
 - bottom edge 5
 - display 9
 - left edge 8
 - rear 9
 - right edge 6
 - top-edge 5
- connectors, service considerations 18
- ctrl+alt+del button 5

D

- digital pen
 - changing the battery 24
 - illustrated 13
 - spare part number 13, 24

- display component
 - illustrated 9
- display panel, product description 1
- dock
 - illustrated 13
 - removal 25
 - spare part number 13, 25
- docking, product description 2
- drives, preventing damage 19

E

- electrostatic discharge 19
- equipment guidelines 22
- Ethernet, product description 1
- external media cards, product description 2

F

- folio case
 - illustrated 13
 - spare part number 13

G

- graphics, product description 1
- grounding guidelines 19
- guidelines
 - equipment 22
 - grounding 19
 - packaging 21
 - transporting 21
 - workstation 21

H

- headphone jack 7
- home button 5
- HP Slate Dock
 - illustrated 13

- removal 25
- spare part number 13, 25

K

- keyboard button 8
- keyboard, product description 2

L

- label tray
 - location 6
 - opening 7
- left-edge components 8

M

- memory module, product description 1
- microphone
 - location 8
 - product description 1
- microphone jack 7
- model name 1

O

- operating system, product description 2
- optical drive, product description 1

P

- packaging guidelines 21
- pen
 - illustrated 13
 - spare part number 13
- plastic parts, service considerations 18
- pointing device, product description 2

- ports
 - product description 2
 - Universal Serial Bus (USB) 5
- power connector 5
- power cord
 - illustrated 12
 - set requirements 37
 - spare part numbers 12
- power light 6
- power requirements, product description 2
- power switch 6
- PowerLock icon 6
- primary storage, product description 1
- processor, product description 1
- product description
 - audio 1
 - chipset 1
 - display panel 1
 - docking 2
 - Ethernet 1
 - external media cards 2
 - graphics 1
 - keyboard 2
 - memory module 1
 - microphone 1
 - modem 1
 - operating system 2
 - optical drive 1
 - pointing device 2
 - ports 2
 - power requirements 2
 - primary storage 1
 - processor 1
 - product name 1
 - security 2
 - serviceability 3
 - video 1
 - wireless 2
- product name 1

R

- rear components 9
- removal/replacement
 - preliminaries 18
 - procedures 23
- right-edge components 6
- RJ45-to-USB adapter cable, spare part number 13

S

- SD Card Reader 8
- security, product description 2
- service considerations
 - cables 18
 - connectors 18
 - plastic parts 18
- serviceability, product description 3
- speakers, location 5

T

- top-edge components 5
- transporting guidelines 21

U

- Universal Serial Bus (USB) port 5

V

- video, product description 1
- volume down button 5
- volume up button 5

W

- wireless, product description 2
- workstation guidelines 21

