



SAMSUNG

User Manual

ST96

This user manual includes detailed usage instructions for your camera. Please read this manual thoroughly.

 [Click a topic](#)

Basic troubleshooting

Quick reference

Contents

Basic functions

Extended functions

Shooting options

Playback/Editing

Settings

Appendixes

Index

Health and safety information

Always comply with the following precautions and usage tips to avoid dangerous situations and ensure peak performance of your camera.



Warning—situations that could cause injury to yourself or others

Do not disassemble or attempt to repair your camera.

This may result in electric shock or damage to the camera.

Do not use your camera near flammable or explosive gases and liquids.

This may cause a fire or explosion.

Do not insert flammable materials into the camera or store these materials near the camera.

This may cause a fire or electric shock.

Do not handle your camera with wet hands.

This may result in electric shock.

Prevent damage to subjects' eyesight.

Do not use the flash in close proximity (closer than 1 m/3 ft) to people or animals. If you use the flash too close to your subject's eyes, this can cause temporary or permanent eyesight damage.

Keep your camera away from small children and pets.

Keep your camera and all accessories out of the reach of small children and animals. Small parts may cause choking or serious injury if swallowed. Moving parts and accessories may present physical dangers as well.

Do not expose the camera to direct sunlight or high temperatures for an extended period of time.

Prolonged exposure to sunlight or extreme temperatures can cause permanent damage to your camera's internal components.

Avoid covering the camera or charger with blankets or clothes.

The camera may overheat, which may distort the camera or cause a fire.

If liquid or foreign objects enter your camera, immediately disconnect all power sources, such as the battery or charger, and then contact a Samsung service center.



Caution—situations that could cause damage to your camera or other equipment

Remove the batteries from your camera when storing it for an extended period of time.

Installed batteries may leak or corrode over time and cause serious damage to your camera.

Use only authentic, manufacturer-recommended, Lithium-ion replacement batteries. Do not damage or heat the battery.

Inauthentic, damaged, or heated batteries may cause a fire or personal injury.

Use only Samsung-approved batteries, chargers, cables and accessories.

- Using unauthorized batteries, chargers, cables or accessories can cause batteries to explode, damage your camera, or cause injury.
- Samsung is not responsible for damage or injuries caused by unapproved batteries, chargers, cables or accessories.

Use the battery only for its intended purpose.

Misusing the battery may cause a fire or electric shock.

Do not touch the flash while it fires.

The flash is very hot when fired and may burn your skin.

When you use AC charger, turn off the camera before you disconnect the power to the AC charger.

Failing to do so may result in fire or electric shock.

Disconnect the charger from the wall socket when not in use.

Failing to do so may result in fire or electric shock.

Do not use a damaged power supply cord, plug, or loose outlet when you charge batteries.

This may cause a fire or electric shock.

Do not allow the AC charger to come in contact with the +/- terminals on the battery.

This may cause a fire or electric shock.

Do not force the camera's parts or apply pressure to the camera.

This may cause your camera to malfunction.

Exercise caution when you connect cables or adapters and install batteries and memory cards.

If you force the connectors, improperly connect cables, or improperly install batteries and memory cards, you can damage ports, connectors, and accessories.

Keep cards with magnetic strips away from the camera case.

Information stored on the card may be damaged or erased.

Never use a damaged charger, battery, or memory card.

This may result in electric shock or camera malfunction or cause a fire.

Check that the camera is operating properly before use.

The manufacturer takes no responsibility for any loss of files or damage that may result from camera malfunction or improper use.

You must plug the small end of the USB cable into your camera.

If the cable is reversed, it may damage your files. The manufacturer is not responsible for any loss of data.

Copyright information

- Microsoft Windows and the Windows logo are registered trademarks of the Microsoft Corporation.
- Mac is a registered trademark of the Apple Corporation.
- microSD™ and microSDHC™ are registered trademarks of the SD Association.
- HDMI, the HDMI logo and the term "High Definition Multimedia Interface" are trademarks or registered trademarks of HDMI Licensing LLC.
- Trademarks and trade names used in this manual are the property of their respective owners.

- Camera specifications or contents of this manual may be changed without prior notice due to upgrade of camera functions.
- You are not allowed to reuse or distribute any part of this manual without prior permission.
- For Open Source License information, refer to the 'OpenSourceInfo.pdf' in the provided CD-ROM.

Outline of the User Manual

Basic functions 12

Learn about your camera's layout, icons, and basic functions for shooting.

Extended functions 33

Learn how to capture a photo and record a video by selecting a mode.

Shooting options 51

Learn how to set the options in Shooting mode.

Playback/Editing 75

Learn how to play back photos or videos, and edit photos or videos. Also, learn how to connect your camera to your computer, photo printer, TV, HDTV, or 3D TV.







Settings 104

Refer to options to configure your camera's settings.

Appendixes 110

Get information about error messages, specifications, and maintenance.

Indicators used in this manual

Shooting mode	Indicator
Smart Auto	
Program	
Scene	
3D Photo	
DUAL IS	
Panorama	
Movie	

Shooting mode icons

These icons appear in the text when a function is available in a mode. See the example below.



Note: The  mode may not support functions for all scenes.

For example:





Adjusting the exposure manually (EV)

 Available in Program, DUAL IS, and Movie modes

Depending on the intensity of the ambient light, your photos may be too bright or dark. In these cases, you can adjust the exposure to get a better photo.

 ▲ Darker (-)  ▲ Neutral (0)  ▲ Brighter (+)

Icons used in this manual

Icon	Function
	Additional information
	Safety warnings and precautions
[]	Camera buttons. For example, [Shutter] represents the shutter button.
()	Page number of related information
→	The order of options or menus you must select to perform a step; for example: Select  → Photo Size (represents Select  , and then select Photo Size).
*	Annotation

Expressions used in this manual

Pressing the shutter

- Half-press [**Shutter**]: press the shutter halfway down
- Press [**Shutter**]: press the shutter all the way down

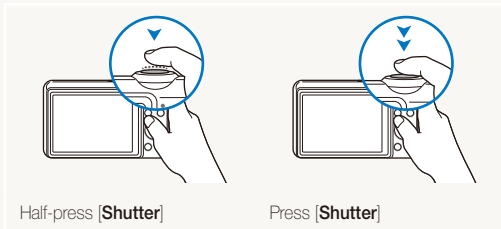

Subject, background, and composition

- **Subject**: the main object in a scene, such as a person, animal, or still life
- **Background**: the objects around the subject
- **Composition**: the combination of a subject and background

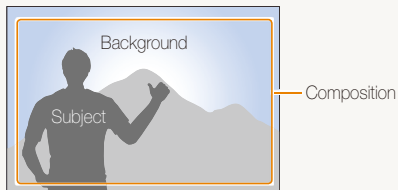

Exposure (Brightness)

The amount of light that enters your camera determines the exposure. You can alter the exposure with shutter speed, aperture value, and ISO sensitivity. By altering the exposure, your photos will be darker or lighter.

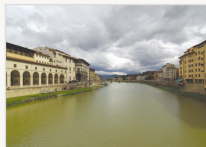















▲ Normal exposure



▲ Overexposure (too bright)

Basic troubleshooting

Learn to solve common problems by setting shooting options.

	The subject's eyes appear red.	<p>Red eye occurs when the subject's eyes reflect light from the camera flash.</p> <ul style="list-style-type: none">• Set the flash option to  Red-eye or  Red-eye Fix. (p. 55)• If the photo has already been captured, select  Red-eye Fix in the edit menu. (p. 91)
	Photos have dust spots.	<p>If dust particles are present in the air, you may capture them in photos when you use the flash.</p> <ul style="list-style-type: none">• Turn off the flash or avoid capturing photos in a dusty place.• Set ISO sensitivity options. (p. 57)
	Photos are blurred.	<p>Blurring can occur if you capture photos in low light conditions or hold the camera incorrectly.</p> <ul style="list-style-type: none">• Use the OIS function or half-press [Shutter] to ensure the subject is focused. (p. 31)• Use the  mode. (p. 43)
	Photos are blurred when shooting at night.	<p>As the camera tries to let in more light, the shutter speed slows. This can make it difficult to hold the camera steady long enough to take a clear picture and may result in camera shake.</p> <ul style="list-style-type: none">• Select  Night in  mode. (p. 36)• Turn on the flash. (p. 55)• Set ISO sensitivity options. (p. 57)• Use a tripod to prevent your camera from shaking.
	Subjects come out too dark because of backlighting.	<p>When the light source is behind the subject or when there is a high contrast between light and dark areas, the subject may appear too dark.</p> <ul style="list-style-type: none">• Avoid shooting toward the sun.• Select  Backlight in  mode. (p. 36)• Set the flash option to  Fill in. (p. 55)• Adjust the exposure. (p. 66)• Set the metering option to  Spot if a subject is in the center of the frame. (p. 67)

Quick reference



Capturing photos of people

- mode > Beauty Shot ▶ 39
- Red-eye/Red-eye Fix (to prevent or correct red-eye) ▶ 55
- Face Detection ▶ 61
- Self-Portrait ▶ 62



Capturing photos at night or in the dark

- mode > Night, Sunset, Dawn ▶ 36
- Flash options ▶ 55
- ISO sensitivity (to adjust the sensitivity to light) ▶ 57



Capturing action photos

- High-speed burst mode ▶ 70
- Precapture ▶ 71



Adjusting the exposure (brightness)

- mode > HDR ▶ 37
- ISO sensitivity (to adjust the sensitivity to light) ▶ 57
- EV (to adjust exposure) ▶ 66
- Metering ▶ 67
- AEB ▶ 71



Capturing panoramic action photos

- mode > Action Panorama ▶ 46



Capturing photos of text, insects, or flowers

- mode > Text ▶ 36
- Macro ▶ 58



Capturing photos of scenery

- mode > Landscape ▶ 36
- mode ▶ 44



Capturing 3D photos

- mode ▶ 42
- mode > 3D Panorama ▶ 44



Applying effects to photos

- mode > Magic Frame ▶ 38
- mode > Zooming Shot ▶ 40
- Smart Filter effects ▶ 72
- Image Adjust (to adjust Contrast, Sharpness, or Saturation) ▶ 74



Reducing camera shake

- Optical Image Stabilization (OIS) ▶ 30
- mode ▶ 43

- Viewing files by category in Smart Album ▶ 79
- Viewing files as thumbnails ▶ 80
- Deleting all files on the memory card ▶ 81
- Viewing files as a slide show ▶ 84
- Viewing files on a TV, HDTV, or 3D TV ▶ 94
- Connecting your camera to a computer ▶ 97
- Adjusting sound and volume ▶ 106
- Adjusting the brightness of the display ▶ 106
- Changing the display language ▶ 107
- Setting the date and time ▶ 107
- Before contacting a service center ▶ 121

Contents

Basic functions	12
Unpacking	13
Camera layout	14
Inserting the battery and memory card	17
Charging the battery and turning on your camera	18
Charging the battery	18
Turning on your camera	18
Performing the initial setup	19
Learning icons	21
Selecting options or menus	22
Using [MENU]	22
Using [Fn]	24
Setting the display and sound	25
Setting the display type	25
Setting the sound	26
Capturing photos	27
Zooming	28
Reducing camera shake (OIS)	30
Tips for getting a clearer photo	31

Extended functions	33
Using the Smart Auto mode	34
Using the Scene mode	36
Using the HDR mode	37
Using the Magic Frame mode	38
Using the Beauty Shot mode	39
Using the Zooming Shot mode	40
Using the Program mode	41
Using the 3D Photo mode	42
Using the DUAL IS mode	43
Using the Panorama mode	44
Using the 2D or 3D Panorama mode	44
Using the Action Panorama mode	46
Using the Movie mode	47
Recording high-speed videos	49
Using the Smart Scene Detection mode	50

Shooting options	51	Adjusting brightness and color	66
Selecting a resolution and quality	52	Adjusting the exposure manually (EV)	66
Selecting a resolution	52	Changing the metering option	67
Setting the photo quality	53	Selecting a light source (White balance)	68
Using the timer	54	Using burst modes	70
Shooting in the dark	55	Capturing photos in the High-speed burst mode	70
Preventing red-eye	55	Capturing photos in the Precapture mode	71
Using the flash	55	Capturing photos in the AEB mode	71
Adjusting the ISO sensitivity	57	Applying effects/Adjusting images	72
Changing the camera's focus	58	Applying Smart Filter effects	72
Using macro	58	Adjusting your photos	74
Using auto focus	58		
Using tracking auto focus	59		
Adjusting the focus area	60		
Using Face Detection	61		
Detecting faces	61		
Capturing a self portrait shot	62		
Capturing a smile shot	62		
Detecting eye blinking	63		
Using Smart Face Recognition	63		
Registering faces as your favorites (My Star)	64		

Playback/Editing	75
Viewing photos or videos in Playback mode	76
Starting Playback mode	76
Viewing photos	82
Playing a video	85
Using the Creative Movie Maker mode	87
Making a movie with the Creative Movie Maker	87
View a movie made in the Creative Movie Maker mode ..	88
Editing a photo	89
Resizing photos	89
Rotating a photo	89
Applying Smart Filter effects	90
Adjusting your photos	91
Creating a print order (DPOF)	92
Viewing files on a TV, HDTV, or 3D TV	94
Transferring files to your Windows computer	97
Transferring files with Intelli-studio	98
Transferring files by connecting the camera as a removable disk	100
Disconnecting the camera (for Windows XP)	101
Transferring files to your Mac computer	102
Printing photos with a PictBridge photo printer	103

Settings	104
Settings menu	105
Accessing the settings menu	105
Sound	106
Display	106
Settings	107

Appendixes	110
Error messages	111
Camera maintenance	112
Cleaning your camera	112
Using or storing the camera	113
About memory cards	114
About the battery	117
Before contacting a service center	121
Camera specifications	124
Glossary	128
FCC notice	133
Index	134

Basic functions

Learn about your camera's layout, icons, and basic functions for shooting.

Unpacking	13	Setting the display and sound	25
Camera layout	14	Setting the display type	25
Inserting the battery and memory card ...	17	Setting the sound	26
Charging the battery and turning on your camera	18	Capturing photos	27
Charging the battery	18	Zooming	28
Turning on your camera	18	Reducing camera shake (OIS)	30
Performing the initial setup	19	Tips for getting a clearer photo	31
Learning icons	21		
Selecting options or menus	22		
Using [MENU]	22		
Using [Fn]	24		

Unpacking

The following items are included in your product box.

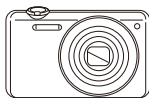

Camera



AC adapter/
USB cable

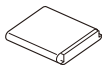

Rechargeable battery



Strap



User Manual CD-ROM



Quick Start Guide

Optional accessories



Camera case

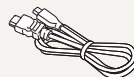

HDMI cable

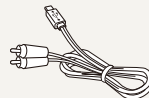

AV cable

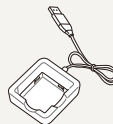

Battery charger



Memory card/
Memory card adapter



- The illustrations may differ slightly from the items shipped with your product.
- You can purchase optional accessories at a retailer or a Samsung service center. Samsung is not responsible for any problems caused by using unauthorized accessories.





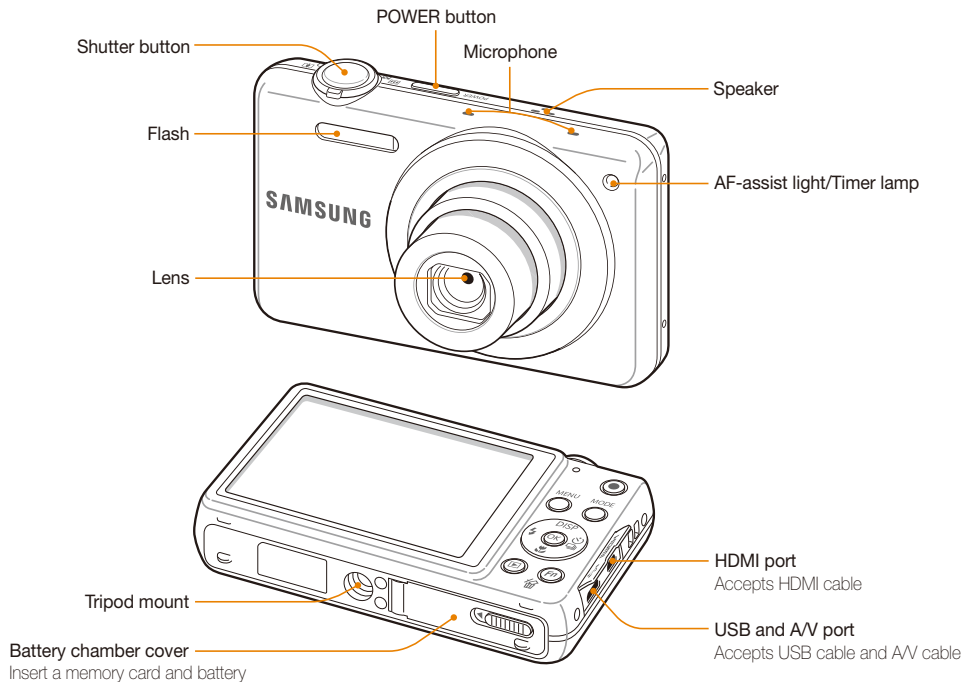

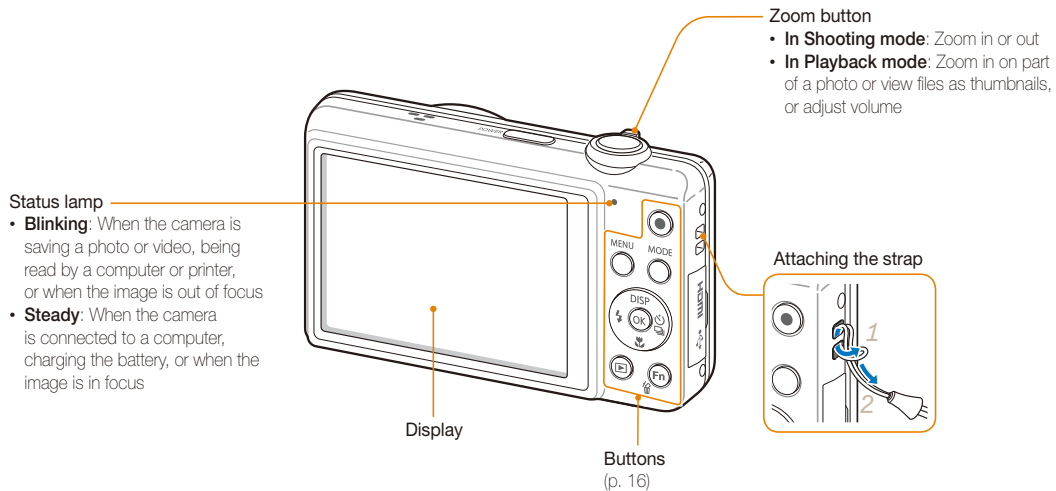

















Camera layout







Before you start, familiarize yourself with your camera's parts and their functions.





Buttons

Button	Description																
	Start recording a video.																
<small>MENU</small> 	Access options or menus.																
	Select a shooting mode.																
	<table border="1"> <thead> <tr> <th>Mode</th> <th>Description</th> </tr> </thead> <tbody> <tr> <td></td> <td>Smart Auto: Capture a photo with a scene mode selected automatically by the camera.</td> </tr> <tr> <td></td> <td>Program: Capture a photo by setting options except the shutter speed and aperture value which the camera sets automatically.</td> </tr> <tr> <td></td> <td>Scene: Capture a photo with options preset for a specific scene.</td> </tr> <tr> <td></td> <td>3D Photo: Capture scenes with a 3D effect. (The 3D effect works only on a 3D TV or 3D monitor.)</td> </tr> <tr> <td></td> <td>DUAL IS: Capture a photo with options that reduce camera shake.</td> </tr> <tr> <td></td> <td>Panorama: Capture and combine a series of photos to create a panoramic image.</td> </tr> <tr> <td></td> <td>Movie: Customize settings to record a video.</td> </tr> </tbody> </table>	Mode	Description		Smart Auto: Capture a photo with a scene mode selected automatically by the camera.		Program: Capture a photo by setting options except the shutter speed and aperture value which the camera sets automatically.		Scene: Capture a photo with options preset for a specific scene.		3D Photo: Capture scenes with a 3D effect. (The 3D effect works only on a 3D TV or 3D monitor.)		DUAL IS: Capture a photo with options that reduce camera shake.		Panorama: Capture and combine a series of photos to create a panoramic image.		Movie: Customize settings to record a video.
Mode	Description																
	Smart Auto: Capture a photo with a scene mode selected automatically by the camera.																
	Program: Capture a photo by setting options except the shutter speed and aperture value which the camera sets automatically.																
	Scene: Capture a photo with options preset for a specific scene.																
	3D Photo: Capture scenes with a 3D effect. (The 3D effect works only on a 3D TV or 3D monitor.)																
	DUAL IS: Capture a photo with options that reduce camera shake.																
	Panorama: Capture and combine a series of photos to create a panoramic image.																
	Movie: Customize settings to record a video.																

Button	Description		
	Basic functions	Other functions	
	DISP	Change the display option.	Move up
		Change the macro option.	Move down
		Change the flash option.	Move left
	Change the timer or burst option.	Move right	
	Confirm the highlighted option or menu.		
	Enter Playback mode.		
	<ul style="list-style-type: none"> Access options in Shooting mode. Delete files in Playback mode. 		

Inserting the battery and memory card

Learn how to insert the battery and an optional memory card into the camera.

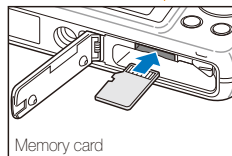
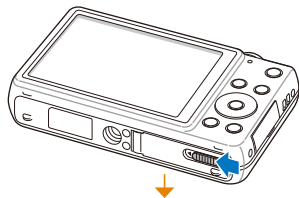

Insert a memory card with the gold-colored contacts facing up.

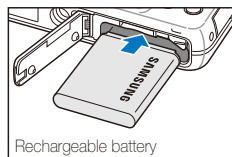

Insert the battery with the Samsung logo facing up.

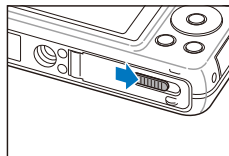
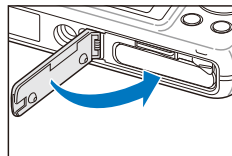

Removing the battery and memory card

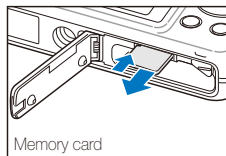

Push the card gently until it disengages from the camera, and then pull it out of the slot.

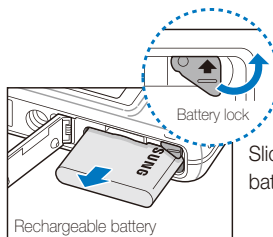

Slide the lock up to release the battery.



You can use the internal memory for temporary storage if a memory card is not inserted.

Charging the battery and turning on your camera

Charging the battery

Before you use the camera for the first time, you must charge the battery. Plug the small end of the USB cable into your camera, and then plug the other end of the USB cable into the AC adapter.

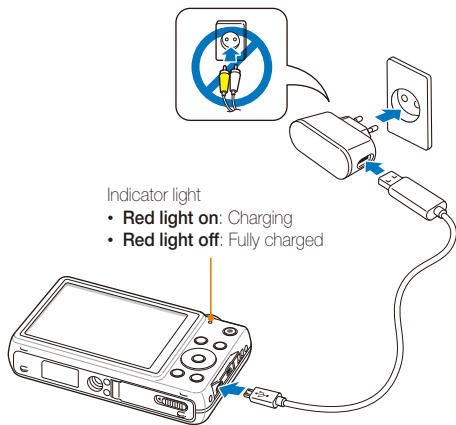

Use only the AC adapter and USB cable supplied with your camera. If you use another AC adapter (such as SAC-48), the camera battery may not charge or work properly.

Turning on your camera

Press **[POWER]** to turn your camera on or off.

- The initial setup screen appears when you turn on the camera for the first time. (p. 19)

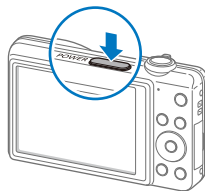

Turning on your camera in Playback mode

Press **[▶]**. The camera turns on and immediately accesses Playback mode.

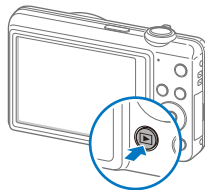

If you turn on your camera by pressing and holding **[▶]** for about 5 seconds, the camera does not emit any sounds.

Performing the initial setup

When you turn on your camera for the first time, the initial setup screen appears. Follow the steps below to configure the camera's basic settings.

- 1 Verify that **Language** is highlighted, and then press [OK] or [OK].

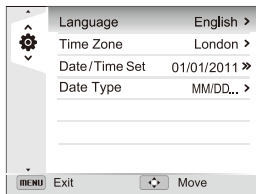

- 2 Press [DISP/🌿/🔌/📶] to select a language, and then press [OK].
- 3 Press [🌿] to select **Time Zone**, and then press [OK] or [OK].

- 4 Press [DISP/🌿] to select **Home**, and then press [OK].
 - When you travel to another country, select **Visit**, and then select a new time zone.
- 5 Press [🔌/📶] to select a time zone, and then press [OK].
 - To set daylight-savings time, press [DISP].

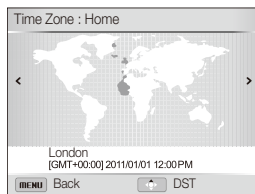

- 6 Press [**DATE**] to select **Date/Time Set**, and then press [**OK**] or [**OK**].

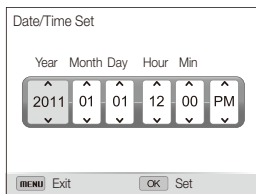

- The screen may differ depending on the language selected.

- 7 Press [**DOWN**] to select an item.

- 8 Press [**DISP/DATE**] to set the date and time, and then press [**OK**].

- 9 Press [**DATE**] to select **Date Type**, and then press [**OK**] or [**OK**].

- 10 Press [**DISP/DATE**] to select a date type, and then press [**OK**].

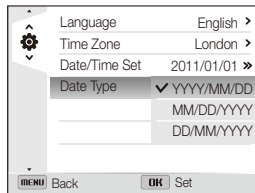

- The default date type may differ depending on the language selected.

- 11 Press [**MENU**] to switch to Shooting mode.

Learning icons

The icons the camera displays on the screen change according to the mode you select or the options you set.

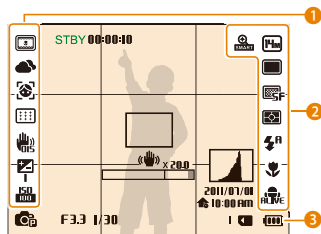

1 Shooting options (left)

Icon	Description
	Smart filter
	Face tone
	Image adjustment (contrast, sharpness, and saturation)
	White balance
	White balance adjusted
	Face retouch
	Face detection
	Focus area
	Optical Image Stabilization (OIS)
	EV adjusted
	ISO sensitivity

2 Shooting options (right)

Icon	Description
	Smart zoom on
	Photo resolution
	Video resolution
	Single shot mode
	High-speed burst mode
	Precapture mode
	AEB mode
	Timer
	Frame rate
	Photo quality
	Metering
	Flash
	Flash intensity adjusted
	Auto focus option
	Sound Alive on

3 Shooting information

Icon	Description
	Shooting mode
F3.3	Aperture value
1/30	Shutter speed
1	Available number of photos
	Memory card inserted
	<ul style="list-style-type: none"> : Fully charged : Partially charged : Empty (Recharge)
00:00:10	Available recording time
	Auto focus frame
	Camera shake
	Zoom indicator
x 20.0	Zoom ratio
	Histogram (p. 25)
2011/07/01 10:00 AM	Current time and date

Selecting options or menus

To select an option or a menu, press **[MENU]** or **[Fn]**.

Using **[MENU]**

To select options, press **[MENU]**, and then press **[DISP/⬇️/⚡️/📄]** or **[OK]**.

- 1 In Shooting mode, press **[MENU]**.
- 2 Select an option or a menu.
 - To move up or down, press **[DISP]** or **[⬆️]**.
 - To move left or right, press **[⚡️]** or **[📄]**.

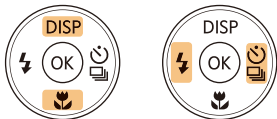

- 3 Press **[OK]** to confirm the highlighted option or menu.

Going back to the previous menu

Press **[MENU]** again to go back to the previous menu.

 Half-press **[Shutter]** to return to Shooting mode.

For example, to select a White Balance option in Program mode:

- 1 In Shooting mode, press **[MODE]**.
- 2 Select .
- 3 Press **[MENU]**.

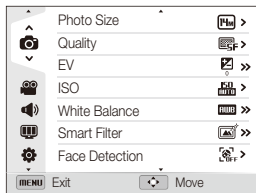

- 4 Press **[DISP/🌸]** to select , and then press **[👉]** or **[OK]**.

- 5 Press **[DISP/🌸]** to select **White Balance**, and then press **[👉]** or **[OK]**.

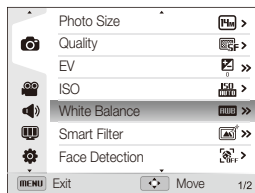

- 6 Press **[🌘/👉]** to select a White Balance option.

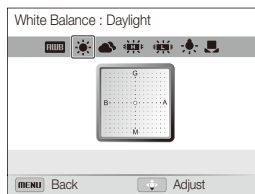

- 7 Press **[OK]** to save your settings.
- 8 Press **[MENU]** to return to Shooting mode.

Using [Fn]

You can access shooting options by pressing [Fn], but some options are not available.

For example, to select a White Balance option in Program mode:

- 1 In Shooting mode, press [MODE].
- 2 Select .
- 3 Press [Fn].

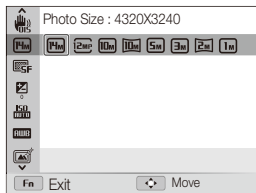

- 4 Press [DISP/☘] to scroll to **WB**.

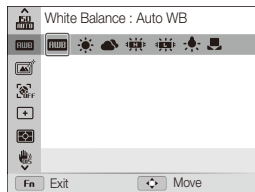

- 5 Press [/☘] to select a White Balance option.

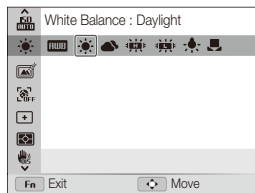

- 6 Press [OK] to save your settings.

Setting the display and sound

Learn how to change the basic display information and sound settings.

Setting the display type

You can select a display type for the Shooting or Playback mode. Each type displays different shooting or playback information. See the table below.

Press **[DISP]** repeatedly to change the display type.

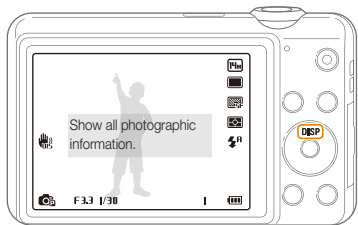

Mode	Description
Shooting	<ul style="list-style-type: none">• Hide all information about shooting.• Hide information about shooting, except the information on the bottom line.• Display all information about shooting.• Display histogram.
Playback	<ul style="list-style-type: none">• Hide all information about the current file.• Display information about the current file, except the shooting settings and histogram.• Display all information about the current file.

About histograms

A histogram is a graph that illustrates how light is distributed in your photo. If the histogram has a high peak on the left, the photo is underexposed and will appear dark. A peak on the right of the graph means that the photo is overexposed and will appear washed out. The height of the peaks is related to color information. The more of a particular color, the taller the peak.



▲ Under-exposed

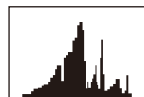

▲ Well-exposed



▲ Over-exposed

Setting the sound

Turn on or off the sound your camera emits when you perform functions.

- 1 In Shooting or Playback mode, press **[MENU]**.
- 2 Select  → **Beep Sound**.
- 3 Select an option.

Option	Description
Off	The camera does not emit any sounds.
On	The camera emits sounds.

Capturing photos

Learn how to capture photos easily and quickly in Smart Auto mode.

- 1 In Shooting mode, press **[MODE]**.
- 2 Select .
- 3 Align your subject in the frame.

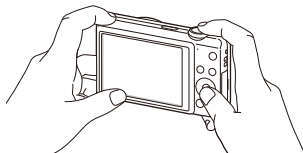

- 4 Half-press **[Shutter]** to focus.
 - A green frame means the subject is in focus.
 - A red frame means the subject is out of focus.

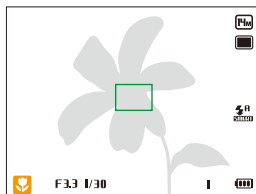

- 5 Press **[Shutter]** to capture a photo.
- 6 Press **[Q]** to view the captured photo.
 - To delete the photo, press **[Fn]**, and then select **Yes**.
- 7 Press **[Q]** to return to Shooting mode.



See page 31 for tips to get clearer photos.

Zooming

You can capture close-up photos by adjusting the zoom.

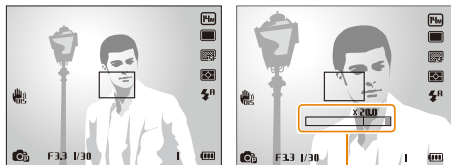

Zoom ratio



Digital zoom



The Digital zoom is supported by default in Shooting mode. If you zoom in on a subject in Shooting mode and the zoom indicator is in the digital range, your camera is using the Digital zoom. By using both the 5X Optical zoom and 4X Digital zoom, you can zoom in up to 20 times.

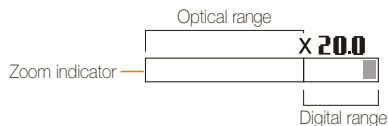

- The Digital zoom is not available with the Face detection option, Smart Filter effect, Tracking AF option, or Burst option.
- If you capture a photo with the Digital zoom, the photo quality may be lower than normal.

Smart zoom



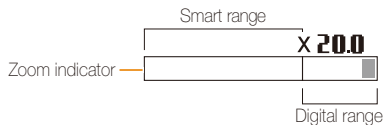

You can use 7X Smart zoom which lets you zoom in with less degradation of picture quality than the Optical zoom and Digital zoom. By using both the Smart zoom and Digital zoom, you can zoom in up to 20 times.



- Smart zoom is not available with the Face detection option, Smart Filter effect, Tracking AF option, or Burst option.
- If you capture a photo with the Smart zoom, the photo quality may be lower than normal.

Setting Smart zoom

- 1 In Shooting mode, press **[MENU]**.
- 2 Select  → **Smart Zoom**.
- 3 Select an option.

Icon	Description
	Off: The Smart zoom is deactivated.
	On: The Smart zoom is activated.

Reducing camera shake (OIS)



Reduce camera shake optically in Shooting mode.



▲ Before correction





▲ After correction

1 In Shooting mode, press **[MENU]**.

2 Select  or  → **OIS**.

3 Select an option.

Icon	Description
	Off: OIS is deactivated.
	On: OIS is activated.



- OIS may not function properly when:
 - you move your camera to follow a moving subject
 - you use the Digital zoom
 - there is too much camera shake
 - the shutter speed is slow (for example, when you capture night scenes)
 - the battery is low
 - you capture a close-up shot
- If you use the OIS function with a tripod, your images may be blurred by the vibration of the OIS sensor. Deactivate the OIS function when you use a tripod.
- If the camera is hit or dropped, the display will be blurry. If this occurs, turn off the camera, and then turn it on again.

Tips for getting a clearer photo

☺ Holding your camera correctly

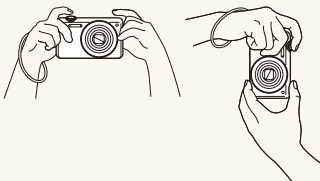

Ensure nothing is blocking the lens, flash, or microphone.

☺ Half-pressing the shutter button

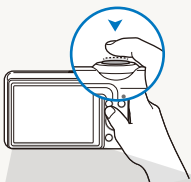

Half-press **[Shutter]** and adjust the focus. The camera adjusts the focus and exposure automatically.

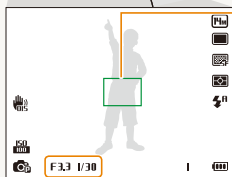

Focus frame

- Press **[Shutter]** to capture the photo if the focus frame appears in green.
- Change the composition and half-press **[Shutter]** again if the focus frame appears in red.

The camera sets the aperture value and shutter speed automatically.

☺ Reducing camera shake



- Set the Optical Image Stabilization option to reduce camera shake optically. (p. 30)
- Select the  mode to reduce camera shake both optically and digitally. (p. 43)

☺ When «» is displayed

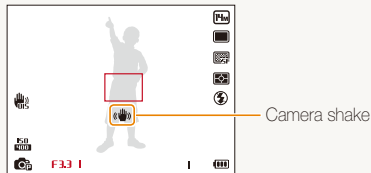

When you shoot in the dark, avoid setting the flash option to **Slow Sync** or **Off**. The aperture remains open longer and it may be harder to hold the camera steady long enough to capture a clear photo.

- Use a tripod or set the flash option to **Fill in**. (p. 55)
- Set ISO sensitivity options. (p. 57)



Preventing your subject from being out of focus

It may be difficult to get your subject in focus when:

- there is little contrast between the subject and background (for example, when your subject is wearing clothing that is similar in color to the background)
- the light source behind the subject is too bright
- the subject is shiny or reflective
- the subject includes horizontal patterns, such as blinds
- the subject is not positioned in the center of the frame



Using the focus lock

Half-press **[Shutter]** to focus. When the subject is in focus, you can reposition the frame to change the composition.

When you are ready, press **[Shutter]** to capture your photo.

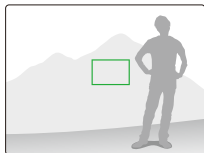
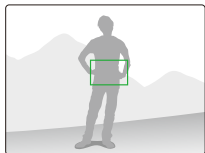

- When you capture photos in low light



Turn on the flash.
(p. 55)

- When subjects are moving rapidly

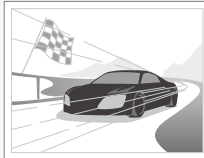

Use the High-speed burst mode or Precapture function.
(p. 70)

Extended functions

Learn how to capture a photo and record a video by selecting a mode.

Using the Smart Auto mode	34	Using the Panorama mode	44
Using the Scene mode	36	Using the 2D or 3D Panorama mode	44
Using the HDR mode	37	Using the Action Panorama mode	46
Using the Magic Frame mode	38	Using the Movie mode	47
Using the Beauty Shot mode	39	Recording high-speed videos	49
Using the Zooming Shot mode	40	Using the Smart Scene Detection mode ...	50
Using the Program mode	41		
Using the 3D Photo mode	42		
Using the DUAL IS mode	43		

Using the Smart Auto mode

In Smart Auto mode, your camera automatically chooses the appropriate camera settings based on the type of scene it detects. The Smart Auto mode is helpful if you are not familiar with the camera settings for various scenes.

- 1 In Shooting mode, press **[MODE]**.
- 2 Select .
- 3 Align your subject in the frame.
 - The camera automatically selects a scene. An appropriate scene icon appears at the bottom left of the screen. The icons are listed below.

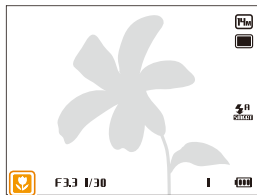



Icon	Description
	Landscapes
	Scenes with bright white backgrounds
	Landscapes at night (when the flash is off)
	Portraits at night
	Landscapes with backlighting

Icon	Description
	Portraits with backlighting
	Portraits
	Close-up photos of objects
	Close-up photos of text
	Sunsets
	Blue skies
	Forested areas
	Close-up photos of colorful subjects
	Camera is stabilized or on a tripod (when shooting in the dark)
	Actively moving subjects
	Fireworks (when using a tripod)

4 Half-press [**Shutter**] to focus.

5 Press [**Shutter**] to capture the photo.



- If the camera does not recognize an appropriate scene mode, it uses the default settings for the  mode.
- Even if it detects a face, the camera may not select a portrait mode depending on the subject's position or lighting.
- The camera may not select the correct scene depending on the shooting conditions, such as camera shake, lighting, or distance to the subject.
- Even if you use a tripod, the camera may not detect the  mode if the subject is moving.
- In  mode, the camera consumes more battery power, because it changes settings often to select appropriate scenes.

Using the Scene mode

In Scene mode, you can capture a photo with options that are preset for a specific scene.

- 1 In Shooting mode, press **[MODE]**.
- 2 Select **SCN**.
- 3 Select a scene.

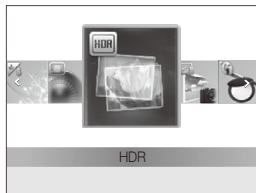

Option	Description
HDR	Capture scenes with emphasis on mid-tones, by minimizing the dark and bright areas.
Magic Frame	Capture scenes with various frame effects.
Beauty Shot	Capture a portrait with options to hide facial imperfections.
Night	Capture scenes at night or in low lighting (using a tripod is recommended).
Landscape	Capture still-life scenes and landscapes.

Option	Description
Text	Clearly capture text from printed or electronic documents.
Sunset	Capture scenes at sunset, with natural-looking reds and yellows.
Dawn	Capture scenes at sunrise.
Backlight	Capture backlit subjects.
Beach & Snow	Reduce underexposure of subjects caused by sunlight reflected from sand or snow.
Zooming Shot	Capture scenes with blurred edges.

- To change a scene mode, press **[MENU]**, and then select **SCN**. You can select any of the scenes listed.

- 4 Align your subject in the frame, and then half-press **[Shutter]** to focus.
- 5 Press **[Shutter]** to capture the photo.

Using the HDR mode

In HDR(High Dynamic Range) mode, your camera captures two photos with different exposures, and then overlays the bright area of the underexposed photo and the dark area of the overexposed photo. You can capture photos with soft, rich colors.



▲ Without HDR effect



▲ With HDR effect

- 1 In Shooting mode, press **[MODE]**.
- 2 Select  → **HDR**.
- 3 Align your subject in the frame, and then half-press **[Shutter]** to focus.

4 Press **[Shutter]** to capture the photo.

- The camera captures 2 photos, and then automatically merges them into a single photo.



- The HDR effect may be affected by camera shake, lighting, movement of the subject, and the shooting environment.
- You cannot use the flash when you use the HDR mode.
- It may take longer to save a photo using the HDR mode.
- When you use the HDR mode, the preview image on the screen and the captured photo may appear slightly larger than a photo captured without this effect.
- When you capture a moving subject using the HDR mode, an afterimage may appear.

Using the Magic Frame mode

In Magic Frame mode, you can apply various frame effects to your photos. The shape and the feel of the photos will change according to the frame you select.

- 1 In Shooting mode, press **[MODE]**.
- 2 Select **SEEN** → **Magic Frame**.
- 3 Press **[MENU]**.
- 4 Select **📷** → **Frame**.
- 5 Select an option.

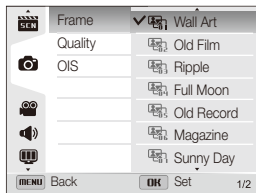

- 6 Press **[MENU]** to return to Shooting mode.
- 7 Align your subject in the frame, and then half-press **[Shutter]** to focus.
- 8 Press **[Shutter]** to capture the photo.



In Magic Frame mode, the resolution is automatically set to **2m**.

Using the Beauty Shot mode

In Beauty Shot mode, you can capture a portrait with options to hide facial imperfections.

1 In Shooting mode, press **[MODE]**.

2 Select  → **Beauty Shot**.

3 Press **[MENU]**.

4 Select  → **Face Tone**.

5 Select an option.

- For example, increase the face tone setting to make skin appear lighter.

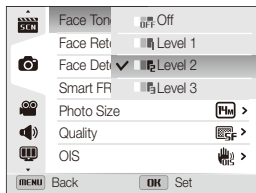

6 Select **Face Retouch**.

7 Select an option.

- For example, increase the face retouch setting to hide more imperfections.

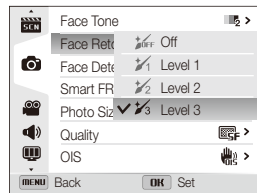

8 Press **[MENU]** to return to Shooting mode.

9 Align your subject in the frame, and then half-press **[Shutter]** to focus.

10 Press **[Shutter]** to capture the photo.



When you use the Beauty Shot mode, the focus distance will be set to Auto Macro.

Using the Zooming Shot mode

In Zooming Shot mode, you can emphasize the center of a photo by blurring the edges.



▲ Without Zooming Shot effect



▲ With Zooming Shot effect

- 1 In Shooting mode, press **[MODE]**.
- 2 Select  → **Zooming Shot**.
- 3 Align your subject in the frame, and then half-press **[Shutter]** to focus.
- 4 Press **[Shutter]** to capture the photo.



In Zooming Shot mode, the resolution is automatically set to **5m** or below.

Using the Program mode

In Program mode, you can set most options, except the shutter speed and aperture value, which the camera sets automatically.

- 1 In Shooting mode, press **[MODE]**.
- 2 Select .
- 3 Set the desired options. (For a list of options, refer to "Shooting options.")

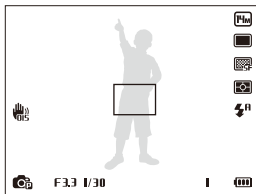

- 4 Align your subject in the frame, and then half-press **[Shutter]** to focus.
- 5 Press **[Shutter]** to capture the photo.

Using the 3D Photo mode

In 3D Photo mode, you can capture scenes with a 3D effect.

- 1 In Shooting mode, press **[MODE]**.
- 2 Select .
- 3 Align your subject in the frame, and then half-press **[Shutter]** to focus.
- 4 Press **[Shutter]** to capture the photo.
 - The camera captures 2 photos in both JPEG and MPO file formats.



- In 3D Photo mode, the resolution is automatically set to **[2M]**.
- In 3D Photo mode, some shooting options are not available.
- You can view an MPO file that supports the 3D effect only on an MPO-compatible display, such as a 3D TV or 3D monitor. On your camera's display, you can view only JPEG files.
- Use proper 3D glasses when you view an MPO file on a 3D TV or 3D monitor.

Using the DUAL IS mode

Reduce camera shake and prevent blurred photos with Optical and Digital Image Stabilization functions.



▲ Before correction

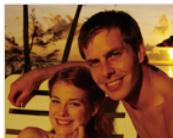

▲ After correction

- 1 In Shooting mode, press **[MODE]**.
- 2 Select .
- 3 Align your subject in the frame, and then half-press **[Shutter]** to focus.
- 4 Press **[Shutter]** to capture the photo.



- The Digital zoom and Smart zoom are not available in  mode.
- The camera will correct photos optically only when the light source is brighter than fluorescent light.
- If your subject is moving rapidly, the photo may be blurry.
- Set the Optical Image Stabilization option to reduce camera shake in different shooting modes. (p. 30)

Using the Panorama mode



In Panorama mode, you can capture a wide panoramic scene in a single photo. Capture and combine a series of photos to create a panoramic image.

Using the 2D or 3D Panorama mode

In Panorama mode, you can capture a normal or 3D panoramic photo.



▲ Shooting example

- 1 In Shooting mode, press **[MODE]**.
- 2 Select .
- 3 Press **[MENU]**.
- 4 Select  → **Panorama** → **Live Panorama** or **3D Panorama**.
- 5 Press **[MENU]** to return to Shooting mode.
- 6 Align your subject in the frame, and then half-press **[Shutter]** to focus.
- 7 Press and hold **[Shutter]** to start shooting.

- 8 With **[Shutter]** pressed, slowly move the camera in the direction you selected.

- In 3D Panorama mode, you can capture a scene only in horizontal directions.
- When the viewfinder is aligned with the next scene, the camera captures the next photo automatically.



- 9 When you are finished, release **[Shutter]**.
- When you have captured all the necessary shots, the camera combines them into one panoramic photo.



- For best results when capturing panoramic photos, avoid the following:
 - moving the camera too quickly or too slowly
 - moving the camera too little to capture the next image
 - moving the camera at irregular speeds
 - shaking the camera
 - changing the camera direction while capturing a photo
 - shooting in dark places
 - capturing moving subjects nearby
 - shooting conditions where the brightness or color of light is changing
- Selecting Panorama mode will disable digital and optical zoom functions. If you select Panorama mode while the lens is zoomed in, the camera automatically zooms out to the default position.
- In Panorama mode, some shooting options are not available.
- The camera may stop shooting due to the shooting composition or the subject's movement.
- To improve photo quality in Panorama mode, your camera may not capture the end of the scene when you stop moving the camera. To capture the entire scene, move your camera slightly beyond the point where you want the scene to end.
- In 3D Panorama mode, your camera may not capture the very beginning or end of a scene due to the nature of the 3D effect. To capture the entire scene, move slightly beyond the beginning and end points you want to capture.



- In 3D Panorama mode, photos are captured in both JPEG and MPO file formats.
- You can view an MPO file that supports the 3D effect only on an MPO-compatible display, such as 3D TV or 3D monitor. On your camera's display, you can view only JPEG files.
- Use proper 3D glasses when you view an MPO file on a 3D TV or 3D monitor.

Using the Action Panorama mode

In Action Panorama mode, you can capture and combine a series of photos of a moving subject.



▲ Shooting example

- 1 In Shooting mode, press **[MODE]**.
- 2 Select .
- 3 Press **[MENU]**.
- 4 Select  → **Panorama** → **Action Panorama**.
- 5 Press **[MENU]** to return to Shooting mode.
- 6 Align your subject in the frame, and then half-press **[Shutter]** to focus.
- 7 Press and hold **[Shutter]** to start shooting.

- 8 With **[Shutter]** pressed, slowly move the camera to the direction you selected.

- If there is more than one moving subject, the camera may not recognize the correct subject.
- If subjects are outside of the guide frame while capturing, the camera does not capture the movement of the subjects.

- 9 When you are finished, release **[Shutter]**.

- The camera automatically combines the shots into one photo.



- For best results when capturing panoramic photos, avoid the following:
 - moving the camera too quickly or too slowly
 - moving the camera too little to capture the next image
 - moving the camera at irregular speeds
 - shaking the camera
 - changing the camera direction while capturing a photo
 - shooting in dark places
 - capturing moving subjects nearby
 - shooting conditions where the brightness or color of light is changing
- The camera may take time to save panoramic photos.
- In Action Panorama mode, some shooting options are not available.

Using the Movie mode

In Movie mode, you can customize settings to record full HD videos of up to 20 minutes in length. The camera saves recorded videos as MP4 (H.264) files.

-  H.264 (MPEG-4 part10/AVC) is a high-compression video format established by the international standard organizations ISO-IEC and ITU-T.
- Some memory cards may not support high definition recording. In this case, set a lower resolution.
- Memory cards with slow writing speeds will not support high-resolution videos and high-speed videos. To record high-resolution or high-speed videos, use memory cards with faster writing speeds.
- If you activate the OIS function while recording a video, the camera may record the operating sound of the OIS function.
- If you use the zoom function when recording a video, the camera may record the noise of the zoom operating. To decrease zoom noise, use the Sound Alive function. See Steps 4 and 5 below.



1 In Shooting mode, press **[MODE]**.

2 Select .

3 Press **[MENU]**.

4 Select  → **Voice**.

5 Select a Sound Alive option.



Icon	Description
	Sound Alive Off: Turn off the Sound Alive function to record the zoom noise.
	Sound Alive On: Turn on the Sound Alive function to reduce the zoom noise.
	Mute: Do not record sounds.

-  Do not block the microphone when you use the Sound Alive function.
- Recordings made with Sound Alive may differ from actual sounds.

6 Set desired options. (For a list of options, refer to "Shooting options.")

7 Press  (Video recording) to start recording.

8 Press  (Video recording) again to stop recording.

-  You can start recording a video in some modes by pressing  (Video recording) without switching the mode to .
- The video frame size may appear smaller while you are recording a video depending on video resolution and frame rate.
- If you perform no operations for approximately 3 minutes while recording a video, the screen will become dim. To activate the screen, perform any camera operation. If you operate POWER, Zoom, Shutter, or Video recording button, the camera will carry out the assigned function, even when the screen is dim.

Pause recording

The camera allows you to temporarily pause a video while recording. With this function, you can record separate scenes as a single video.

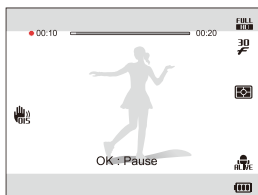

- Press **[OK]** to pause while recording.
- Press **[OK]** to resume.

Capturing still images while recording a video

You can capture still images while recording a video without switching to the photo shooting modes (up to 6 photos). This feature is available only when you use a memory card.

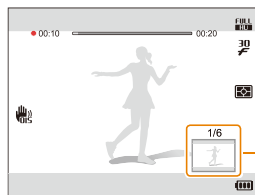

- Press **[Shutter]** to capture images while recording a video.
- Captured images will be saved automatically.



- Captured images will be automatically resized, depending on the size of the recorded video.
- You cannot capture still images while recording high-speed videos.
- You cannot capture still images when you pause the video recording.
- The quality of images captured while recording a video may be lower than those captured normally.

Recording high-speed videos

You can record high-speed videos by setting frame rates. High-speed videos will be played in slow motion at 30 FPS, regardless of the frame rate of the video.



- Memory cards with slow writing speeds do not support high-speed videos.
- You cannot set Smart Filter effects or Smart Scene Detection mode when recording high-speed videos.
- High-speed videos do not support the voice recording.
- The image quality of high-speed video may be lower than normal speed video.



- 1 In Shooting mode, press **[MODE]**.
- 2 Select .
 - mode only allows you to record a high-speed video.
- 3 Press and select a frame rate.

Icon	Description
	440fps : Record 440 frames per second (for up to 10 seconds).
	250fps : Record 250 frames per second (for up to 10 seconds).
	30fps : Record 30 frames per second (for up to 20 minutes). 30fps is not a high-speed recording option.

- 4 Press (Video recording) to start recording.
- 5 Press (Video recording) again to stop recording.



Using the Smart Scene Detection mode

In Smart Scene Detection mode, your camera automatically chooses the appropriate camera settings based on the scene it has detected.

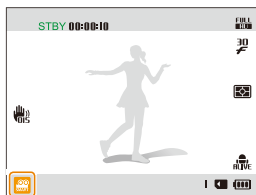
- 1 In Shooting mode, press **[MODE]**.
- 2 Select .
- 3 Press **[MENU]**.
- 4 Select  → **Smart Scene Detection** → **On**.
- 5 Press **[MENU]** to return to Shooting mode.
- 6 Align your subject in the frame.
 - The camera automatically selects a scene. An appropriate scene icon will appear at the bottom left of the screen.



Icon	Description
	Landscapes
	Sunsets
	Blue skies
	Forested areas

- 7 Press  (Video recording) to start recording.
- 8 Press  (Video recording) again to stop recording.



- If the camera does not recognize an appropriate scene mode, it uses the default settings for the Smart Scene Detection mode.
- The camera may not select the correct scene depending on the shooting conditions, such as camera shake, lighting, and distance to the subject.
- Smart Filter effects are not available in Smart Scene Detection mode.

Shooting options

Learn how to set the options in Shooting mode.

Selecting a resolution and quality	52	Detecting eye blinking	63
Selecting a resolution	52	Using Smart Face Recognition	63
Setting the photo quality	53	Registering faces as your favorites (My Star)	64
Using the timer	54	Adjusting brightness and color	66
Shooting in the dark	55	Adjusting the exposure manually (EV)	66
Preventing red-eye	55	Changing the metering option	67
Using the flash	55	Selecting a light source (White balance) ...	68
Adjusting the ISO sensitivity	57	Using burst modes	70
Changing the camera's focus	58	Capturing photos in the High-speed burst mode	70
Using macro	58	Capturing photos in the Precapture mode	71
Using auto focus	58	Capturing photos in the AEB mode	71
Using tracking auto focus	59	Applying effects/Adjusting images	72
Adjusting the focus area	60	Applying Smart Filter effects	72
Using Face Detection	61	Adjusting your photos	74
Detecting faces	61		
Capturing a self portrait shot	62		
Capturing a smile shot	62		

Selecting a resolution and quality

Learn how to change the image resolution and quality settings.

Selecting a resolution

As you increase the resolution, your photo or video will include more pixels, so it can be printed on larger paper or displayed on a larger screen. When you use a high resolution, the file size will also increase.

Setting the photo resolution



- 1 In Shooting mode, press **[MENU]**.
- 2 Select → **Photo Size**.
- 3 Select an option.

Icon	Description
	4320X3240 : Print on an A1 paper.
	4320X2880 : Print on an A1 paper in wide ratio (3:2).
	3648X2736 : Print on an A2 paper.
	4320X2432 : Print on an A2 paper in panorama ratio (16:9) or play back on an HDTV.
	2592X1944 : Print on an A4 paper.
	1984X1488 : Print on an A5 paper.
	1920X1080 : Print on an A5 paper in panorama ratio (16:9) or play back on an HDTV.
	1024X768 : Attach to an email.

Setting the video resolution



- 1 In Shooting mode, press **[MENU]**.
- 2 Select → **Movie Size**.
- 3 Select an option.

Icon	Description
	1920X1080 : Play back high-quality files on an HDTV.
	1280X720 : Play back on an HDTV.
	640X480 : Play back on an analog TV.





If a memory card is not inserted, the camera supports only **VGA**.

Setting the photo quality

Set the photo quality setting. Higher image quality settings will result in larger file sizes. The camera compresses and saves the photos you capture in the JPEG format.

- 1 In Shooting mode, press **[MENU]**.
- 2 Select  → **Quality**.
- 3 Select an option.

Icon	Description
	Super Fine: Capture photos in super high quality.
	Fine: Capture photos in high quality.
	Normal: Capture photos in normal quality.

Using the timer



Learn how to set the timer to delay shooting.

1 In Shooting mode, press [ⓘ].

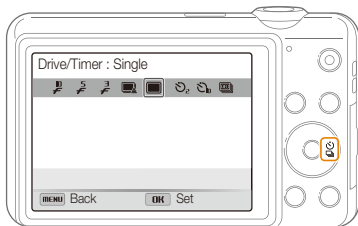

2 Select an option.

Icon	Description
	2 Sec: Capture a photo after a 2-second delay.
	10 Sec: Capture a photo after a 10-second delay.

3 Press **[Shutter]** to start the timer.

- The AF-assist light/timer lamp blinks. The camera will automatically capture a photo after the specified time has elapsed.



- Press **[Shutter]** or [ⓘ] to cancel the timer.
- Depending on the Face Detection options you selected, the timer function may not be available.
- Timer options are not available if you set Burst options.

Shooting in the dark

Learn how to capture photos at night or in low light conditions.

Preventing red-eye

If the flash fires when you capture a photo of a person in the dark, a red glow may appear in the person's eyes. To prevent this, select **Red-eye** or **Red-eye Fix**. Refer to flash options in "Using the flash."



▲ Before correction



▲ After correction



Using the flash



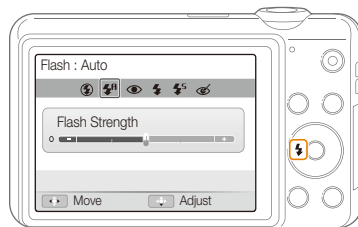



Use the flash when you capture photos in the dark or when you need more light in your photos.

1 In Shooting mode, press .



2 Select an option.

Icon	Description
	Off: <ul style="list-style-type: none">The flash will not fire.The camera will display the shake warning  when you are shooting in low light.
	Auto: The camera will select a proper flash setting for the scene it detects in Smart Auto mode.

Icon	Description
	Auto: The flash will fire automatically when the subject or background is dark.
	Red-eye: <ul style="list-style-type: none"> The flash will fire twice when the subject or background is dark to reduce the red-eye effect. There is an interval between the 2 bursts of the flash. Do not move until the flash fires a second time.
	Fill in: <ul style="list-style-type: none"> The flash always fires. The camera automatically adjusts light intensity.
	Slow Sync: <ul style="list-style-type: none"> The flash fires and the shutter stays open longer. This option is recommended when you want to capture ambient light to reveal more details in the background. Use a tripod to prevent your photos from blurring. The camera will display the shake warning () when you are shooting in low light.
	Red-eye Fix: <ul style="list-style-type: none"> The flash fires when the subject or background is dark and the camera corrects red-eyes through its advanced software analysis. There is an interval between the 2 bursts of the flash. Do not move until the flash fires a second time.



Available options may differ depending on the shooting conditions.



- Flash options are not available if you set Burst options or select **Self-Portrait** or **Blink Detection**.
- Make sure that your subjects are within the recommended distance from the flash. (p. 125)
- If light from the flash is reflected or there is a substantial amount of dust in the air, tiny spots may appear in your photo.

Adjusting the flash intensity

Adjust the flash intensity to avoid over-exposed or under-exposed photos.

- In Shooting mode, press [].
- Scroll to an option.
- Press [].

4 Press [**Flash/ISO**] to adjust the intensity.

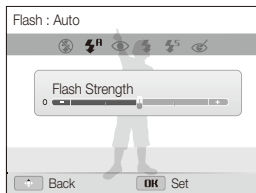

5 Press [**OK**] to save your settings.



- Adjusting the flash intensity may not be effective if:
 - the subject is too close to the camera
 - you set a high ISO sensitivity
 - the exposure value is too big or too small
- In some shooting modes, you cannot use this function.

Adjusting the ISO sensitivity

The ISO sensitivity is the measure of a film's sensitivity to light as defined by the International Organization for Standardization (ISO). The higher ISO sensitivity you select, the more sensitive to light your camera becomes. Use a higher ISO sensitivity to capture better photos and reduce camera shake when not using the flash.

1 In Shooting mode, press [**MENU**].

2 Select  → **ISO**.

3 Select an option.

- Select  to use an appropriate ISO sensitivity based on the brightness of the subject and lighting.



Higher ISO sensitivities may result in more image noise.

Changing the camera's focus

Learn how to adjust the camera's focus to suit the subject and the shooting conditions.

Using macro



Use macro to capture close-up photos of subjects, such as flowers or insects.



- Try to hold the camera firmly to prevent blurry photos.
- Turn off the flash if the distance to the subject is less than 16 in. (40cm)

Using auto focus



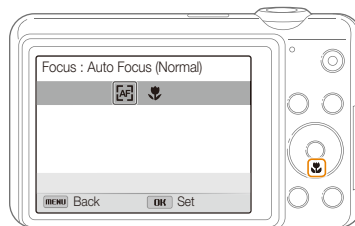

To capture sharp photos, select the appropriate focus option according to your distance from the subject.

1 In Shooting mode, press [AF].



2 Select an option.

Icon	Description
	Auto Focus (Normal): Focus on a subject farther than 31 in. (80 cm) (59 in. [150 cm] when you use the zoom).
	Macro: Manually focus on a subject that is 2-31 in. (5-80 cm) from the camera (39-59 in. [100-150 cm] when you use the zoom).
	Auto Macro: Focus on a subject farther than 2 in. (5 cm) (farther than 39 in. [100 cm] away when you use the zoom).

Available options may differ depending on the shooting conditions.

Using tracking auto focus

Tracking AF allows you to track and auto focus on your subject, even when you are moving.

- 1 In Shooting mode, press **[MENU]**.
- 2 Select  → **Focus Area** → **Tracking AF**.
- 3 Press **[MENU]** to return to Shooting mode.

4 Focus on the subject you want to track, and then press **[OK]**.

- A focus frame appears on the subject and follows the subject as you move the camera.

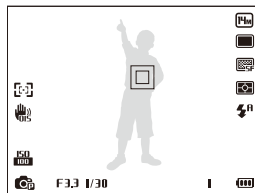

- The white frame means that your camera is tracking the subject.
- When you half-press **[Shutter]**, the green frame means that your subject is in focus.

5 Press **[Shutter]** to capture the photo.





- If you do not select a focus area, the focus frame will appear in the center of the screen.
- Tracking a subject may fail when:
 - the subject is too small
 - the subject moves excessively
 - the subject is backlit or you are shooting in a dark place
 - colors or patterns on the subject and the background are the same
 - the subject includes horizontal patterns, such as blinds
 - the camera shakes excessively
- When tracking a subject fails, the focus frame will appear as a white single-line frame (□).
- If the camera fails to track the subject, you must reselect the subject to track.
- If the camera fails to focus, the focus frame will change to a red single-line frame (□).
- If you use this function, you cannot set Face Detection options, Burst options, Smart zoom, and Smart Filter effects.

Adjusting the focus area

You can get clearer photos by selecting an appropriate focus area according to your subject's location in the scene.

- 1 In Shooting mode, press **[MENU]**.
- 2 Select  → **Focus Area**.
- 3 Select an option.

Icon	Description
	Center AF: Focus on the center of the frame (suitable when subjects are located at or near the center).
	Multi AF: Focus on one or more of 9 possible areas.
	Tracking AF: Focus on and track the subject. (p. 59)

Available shooting options may differ depending on the shooting mode.

Using Face Detection



If you use Face Detection options, your camera can automatically detect a human face. When you focus on a human face, the camera adjusts the exposure automatically. Use **Blink Detection** to detect closed eyes or **Smile Shot** to capture a smiling face. You can also use **Smart Face Recognition** to register faces and prioritize the focus on them.



- When your camera detects a face, it tracks the detected face automatically.
- Face Detection may not be effective when:
 - the subject is far from the camera (The focus frame will appear orange for the Smile Shot and Blink Detection.)
 - it is too bright or too dark
 - the subject is not facing the camera
 - the subject is wearing sunglasses or a mask
 - the subject's facial expression changes drastically
 - the subject is backlit or the lighting conditions are unstable
- Face Detection is not available when you set Smart Filter effects, Image adjustment, or Tracking AF.
- Depending on the shooting options you selected, available Face Detection options may differ.
- Depending on the Face Detection options you selected, the timer function may not be available.
- When you set Face Detection options, the AF area is automatically set to Multi AF.
- Depending on the Face Detection options you selected, Burst options are not available.
- When you capture photos of detected faces, they will be registered in the face list.
- You can view registered faces in order of priority in Playback mode. (p. 77) Even though faces are registered successfully, they may not be classified in Playback mode.
- A face detected in Shooting mode may not appear in the face list or Smart Album.

Detecting faces

Your camera automatically detects up to 10 human faces in one scene.

- 1 In Shooting mode, press **[MENU]**.
- 2 Select  → **Face Detection** → **Normal**.

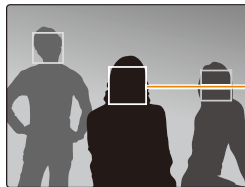

The face nearest the camera or nearest the center of the scene appears in a white focus frame and the rest of the faces appear in gray focus frames.



- The closer you are to the subjects, the quicker your camera will detect faces.
- If you have set Burst options, the camera may not register detected faces.

Capturing a self portrait shot

Capture photos of yourself. The camera sets the focus distance to close-up, and then emits a beep when ready.

- 1 In Shooting mode, press **[MENU]**.
- 2 Select  → **Face Detection** → **Self-Portrait**.
- 3 Press **[MENU]** to return to Shooting mode.
- 4 Compose your shot with the lens facing you.
- 5 When you hear a quick beep, press **[Shutter]**.

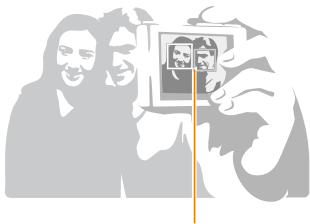

When faces are located in the center, the camera beeps rapidly.



If you turn **Volume** off in the sound settings, the camera will not emit a beep.
(p. 106)

Capturing a smile shot

The camera automatically releases the shutter when it detects a smiling face.

- 1 In Shooting mode, press **[MENU]**.
- 2 Select  → **Face Detection** → **Smile Shot**.
- 3 Press **[MENU]** to return to Shooting mode.
- 4 Compose your shot.
 - The camera automatically releases the shutter when it detects a smiling face.

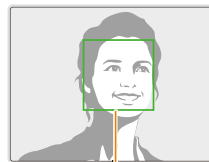

When your subject smiles broadly, your camera can detect the smile more easily.

Detecting eye blinking

If your camera detects closed eyes, it will automatically capture 2 photos in succession.

- 1 In Shooting mode, press **[MENU]**.
- 2 Select  → **Face Detection** → **Blink Detection**.





- Hold your camera still while **"Capturing"** is displayed on the screen.
- If Blink Detection fails, the **"Picture taken with eyes closed."** message appears. Capture another photo.

Using Smart Face Recognition

The camera automatically registers faces that you frequently photograph. The Smart Face Recognition feature will automatically prioritize the focus on those faces and on favorite faces. The Smart Face Recognition feature is available only when you use a memory card.

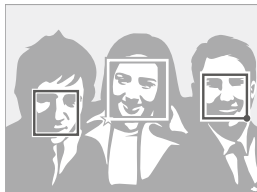
- 1 In Shooting mode, press **[MENU]**.
- 2 Select  → **Face Detection** → **Smart Face Recognition**.



- : Faces that you have registered as favorites. (To register faces as favorites, refer to page 64.)
- : Faces that the camera has automatically registered.



- The camera may recognize and register faces incorrectly depending on lighting conditions, drastic changes in the subject's pose or face, and whether or not the subject is wearing glasses.
- The camera can automatically register up to 12 faces. If the camera recognizes a new face when 12 faces have already been registered, it will replace the lowest priority face with the new one.

Registering faces as your favorites (My Star)

You can register your favorite faces to prioritize the focus and exposure on those faces. This feature is available only when you use a memory card.

- 1 In Shooting mode, press **[MENU]**.
- 2 Select  → **Smart FR Edit** → **My Star**.
- 3 Align your subject's face with the oval guideline, and then press **[Shutter]** to register the face.

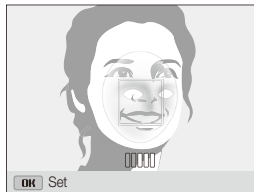



- Capture photos of one person at a time when registering faces.
- Capture 5 photos the subject's face for best results: one each from the front, left, right, above, and below.
- When capturing photos from the left, right, above, and below, instruct the subject not to turn his or her face more than 30 degrees.
- You can register a face even if you capture only one photo of the subject's face.

4 When you are finished capturing the photos, the face list appears.

- Your favorite faces are indicated with a ★ on the face list.



- You can register up to 8 favorite faces.
- The flash will not fire when you register a favorite face.
- If you register the same face twice, you can delete one of the faces in the face list.

Viewing your favorite faces

- 1 In Shooting mode, press **[MENU]**.
- 2 Select  → **Smart FR Edit** → **Face List**.



- To change the ranking of your favorite faces, press **[Fn]**, and then select **Edit Ranking**. (p. 77)
- To delete a favorite face, press **[Fn]**, and then select **Delete**. (p. 78)

Adjusting brightness and color

Learn how to adjust the brightness and color for better image quality.

Adjusting the exposure manually (EV)



Depending on the intensity of the ambient light, your photos may be too bright or dark. In these cases, you can adjust the exposure to get a better photo.



▲ Darker (-)



▲ Neutral (0)



▲ Brighter (+)

1 In Shooting mode, press **[MENU]**.

2 Select  or  → **EV**.

3 Select a value to adjust the exposure.

- The photo will be brighter as the exposure value increases.

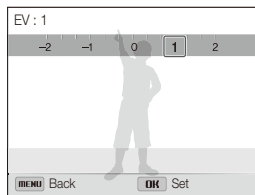

4 Press **[OK]** to save your settings.





- Once you adjust the exposure, the setting will be stored automatically. You may need to change the exposure value later to avoid overexposure or underexposure.
- If you cannot decide on an appropriate exposure, select **AEB** (Auto Exposure Bracket). The camera will capture 3 consecutive photos, each with a different exposure: normal, underexposed, and overexposed. (p. 71)

Changing the metering option

The metering mode refers to the way in which a camera measures the quantity of light. The brightness and lighting of your photos will vary depending on the metering mode you select.

- 1 In Shooting mode, press **[MENU]**.
- 2 Select  or  → **Metering**.
- 3 Select an option.

Icon	Description
	<p>Multi:</p> <ul style="list-style-type: none"> Your camera divides the frame into several areas, and then measures the light intensity of each area. Suitable for general photos.

Icon	Description
	<p>Spot:</p> <ul style="list-style-type: none"> Your camera measures only the light intensity at the very center of the frame. If a subject is not in the center of the frame, your photo may be improperly exposed. Suitable for a subject with backlighting.
	<p>Center-weighted:</p> <ul style="list-style-type: none"> Your camera averages the meter reading of the entire frame with emphasis placed on the center. Suitable for photos with subjects in the center of the frame.

Selecting a light source (White balance)



The color of your photo depends on the type and quality of the light source. If you want the color of your photo to be realistic, select a White Balance setting that is appropriate for the lighting conditions, such as Auto WB, Daylight, Cloudy, or Tungsten.



Auto WB



Daylight



Cloudy









Tungsten

- 1 In Shooting mode, press [MENU].
- 2 Select or → White Balance.
- 3 Select an option.

Icon	Description
	Auto WB: Automatically set the White Balance based on the lighting conditions.
	Daylight: For outdoor photos on a sunny day.
	Cloudy: For outdoor photos on a cloudy day or in shadows.
	Fluorescent_H: For shooting under a daylight fluorescent or 3-way fluorescent light.
	Fluorescent_L: For shooting under white fluorescent light.
	Tungsten: For shooting indoor photos under incandescent bulbs or halogen lamps.
	Custom Set: Use White Balance settings that you defined. (p. 69)

Customizing preset White Balance options

- 1 In Shooting mode, press **[MENU]**.
- 2 Select  or  → **White Balance**.
- 3 Scroll to a desired option.
- 4 Press .
- 5 Press **[DISP]**/// to adjust the value on the coordinates.

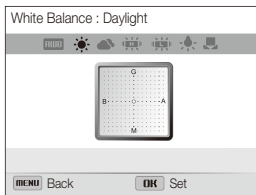



- **G**: Green
- **A**: Amber
- **M**: Magenta
- **B**: Blue

- 6 Press **[OK]** to save your settings.

Defining your own White Balance

You can customize the White Balance by capturing a photo of a white surface, such as a piece of paper, under the lighting conditions in which you intend to capture a photo. The White Balance feature will help you to match the colors in your photo with the actual scene.

- 1 In Shooting mode, press **[MENU]**.
- 2 Select  or  → **White Balance**.
- 3 Scroll to **Custom Set**.
- 4 Aim the lens at a piece of white paper, and then press **[Shutter]**.

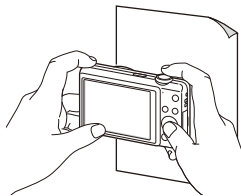





Using burst modes

It can be difficult to capture photos of fast-moving subjects or capture natural facial expressions and gestures of your subjects in photos. Also, it can be difficult to adjust the exposure correctly and select a proper light source. In these cases, select one of the burst modes.



Capturing photos in the High-speed burst mode

- 1 In Shooting mode, press .
- 2 Select an option.

Icon	Description
	10fps: Capture 10 photos per second continuously. (You can capture up to 8 photos in one burst.)
	5fps: Capture 5 photos per second continuously. (You can capture up to 8 photos in one burst.)
	3fps: Capture 3 photos per second continuously. (You can capture up to 8 photos in one burst.)
	Single: Capture a single photo. Single is not a high-speed burst option.

- 3 Align your subject in the frame, and then half-press **[Shutter]** to focus.
- 4 Press and hold **[Shutter]**.
 - While you are pressing **[Shutter]**, the camera captures photos continuously.



- You can use the flash, Smart Zoom, Face Detection options and Smart Filter options only when you select **Single**.
- It may take longer to save the photos depending on the memory card capacity and performance.
- The camera always displays captured photos before returning to Shooting mode.

Capturing photos in the Precapture mode

In Precapture mode, the camera starts shooting before you even press the shutter all the way down. If you do not want to miss the first couple of important shots, simply use this mode and select the photo with the best results after shooting.

- 1 In Shooting mode, press .
- 2 Select **Precapture**.
- 3 Align your subject in the frame, and then half-press **[Shutter]** to focus.
 - The camera captures 7 photos continuously. If you release **[Shutter]** too fast, the camera will capture less than 7 photos.
- 4 Press **[Shutter]**.
 - The camera captures the last photo and then saves all of the captured photos while you are half-pressing **[Shutter]**.
 - If you do not press **[Shutter]** all the way down, the photos captured while you are half-pressing **[Shutter]** will not be saved.

Capturing photos in the AEB mode

You can use the AEB (Auto Exposure Bracket) to capture 3 consecutive photos, each with a different exposure: normal, underexposed, and overexposed. This mode is suitable for the situation that is hard to calculate the appropriate exposure.

- 1 In Shooting mode, press .
- 2 Select **AEB**.
- 3 Align your subject in the frame, and then half-press **[Shutter]** to focus.
- 4 Press **[Shutter]**.
 - The camera captures 3 photos continuously.



Use a tripod to prevent blurry photos.

Applying effects/Adjusting images

Applying Smart Filter effects

Apply various filter effects to your photos and videos to create unique images.



Miniature





Vignetting















Fish-eye





Sketch









- 1 In Shooting mode, press **[MENU]**.
- 2 Select  or  → **Smart Filter**.
- 3 Select an effect.





Available filters in Program mode

Icon	Description
	Normal: No effect
	Miniature: Apply a tilt-shift effect to make the subject appear in miniature.
	Vignetting: Apply the retro-looking colors, high contrast, and strong vignette effect of Lomo cameras.
	Soft Focus: Hide facial imperfections or apply dreamy effects.
	Old Film: Apply a vintage film effect.
	Half Tone Dot: Apply a halftone effect.
	Sketch: Apply a pen sketch effect.
	Fish-eye: Distort close objects to imitate the visual effect of a fisheye lens.
	Classic: Apply a black and white effect.
	Retro: Apply a sepia tone effect.
	Oil Painting: Apply an oil painting effect.
	Cartoon: Apply a cartoon painting effect.



Icon	Description
	Ink Painting: Apply a watercolor painting effect.
	Cross Filter: Add lines that radiate outward from bright objects to imitate the visual effect of a cross filter.

Available filters in Movie mode

Icon	Description
	Normal: No effect
	Palette Effect 1: Create a vivid look with sharp contrast and strong color.
	Palette Effect 2: Make scenes clean and clear.
	Palette Effect 3: Apply a soft brown tone.
	Palette Effect 4: Create a cold and monotone effect.
	Miniature: Apply a tilt-shift effect to make the subject appear in miniature.
	Vignetting: Apply the retro-looking colors, high contrast, and strong vignette effect of Lomo cameras.
	Half Tone Dot: Apply a halftone effect.

Icon	Description
	Sketch: Apply a pen sketch effect.
	Fish-eye: Distort close objects to imitate the visual effect of a fisheye lens.
	Classic: Apply a black and white effect.
	Retro: Apply a sepia tone effect.



- If you select **Miniature** when recording a video, the miniature recording time is displayed with the icon and is shorter than the real recording time.
- If you select **Miniature** when recording a video, you cannot record the video sound and capture still images from a video.
- If you select **Miniature**, **Vignetting**, **Half Tone Dot**, **Sketch**, or **Fish-eye** while recording a video, the recording speed will be set to  and the recording resolution will be set to **VGA**.
- If you select **Sketch**, **Oil Painting**, **Cartoon**, **Ink Painting**, or **Cross Filter** when capturing a photo, the photo size will automatically change to  and below.
- If you set Smart Filter effects, you cannot set the Smart Zoom, Face Recognition options, Image Adjustment options, Burst options, or Tracking AF.

Adjusting your photos

Adjust the sharpness, saturation, or contrast of your photos.

- 1 In Shooting mode, press **[MENU]**.
- 2 Select  → **Image Adjust**.
- 3 Select an option.
 - Contrast
 - Sharpness
 - Saturation

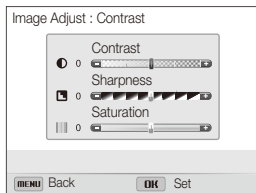

- 4 Press / to adjust each value.

Contrast	Description
-	Decrease the color and brightness.
+	Increase the color and brightness.

Sharpness	Description
-	Soften the edges on your photos (suitable for editing the photos on your computer).
+	Sharpen the edges to improve the clarity of your photos. This may also increase the noise in your photos.

Saturation	Description
-	Decrease the saturation.
+	Increase the saturation.

- 5 Press **[OK]** to save your settings.



- Select 0 if you do not want to apply any effects (suitable for printing).
- If you set adjustment functions, you cannot use Smart Filter options and Face Detection options.

Playback/Editing

Learn how to play back photos or videos, and edit photos or videos. Also, learn how to connect your camera to your computer, photo printer, TV, HDTV, or 3D TV.

Viewing photos or videos in

Playback mode	76
Starting Playback mode	76
Viewing photos	82
Playing a video	85

Using the Creative Movie Maker mode ...

Making a movie with the Creative Movie Maker	87
View a movie made in the Creative Movie Maker mode	88

Editing a photo

Resizing photos	89
Rotating a photo	89
Applying Smart Filter effects	90
Adjusting your photos	91
Creating a print order (DPOF)	92

Viewing files on a TV, HDTV, or 3D TV

Transferring files to your Windows

computer	97
Transferring files with Intelli-studio	98
Transferring files by connecting the camera as a removable disk	100
Disconnecting the camera (for Windows XP)	101

Transferring files to your Mac computer

Printing photos with a PictBridge photo printer	102
.....	103

Viewing photos or videos in Playback mode

Learn how to play back photos or videos and how to manage files.

Starting Playback mode

View photos or play videos stored in your camera.

- 1 Press [▶].
 - The most recent file will be displayed.
 - If the camera is off, it will turn on and display the most recent file.
- 2 Press [⚡/📷] to scroll through files.
 - Press and hold [⚡/📷] to scroll through files quickly.



- If you want to view files stored in the internal memory, remove your memory card.
- The camera will not properly play back files of unsupported sizes or files that were captured with other cameras.

Photo file information

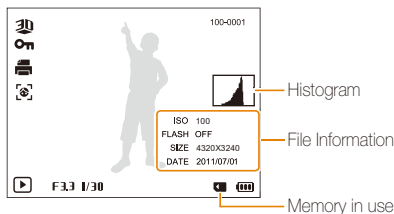

Icon	Description
100-0001	Folder name–File name
	Photo captured in 3D Photo mode
	Photo captured in a High-speed burst mode or in Precapture mode (Viewing files as a folder, p. 78)
	Protected file
	Print order has been set (DPOF)
	Photo includes a registered face (available only when you use a memory card)



To display file information on the screen, press [DISP].

Video file information

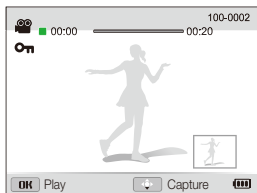

Icon	Description
100-0002	Folder name-File name
00:00	Current playback time
00:20	Video length
	Video file
	Video includes images captured while recording
	Video made in Creative Movie Maker mode
	Protected file
	Image captured while recording a video

Ranking your favorite faces

You can rank your favorite faces. The favorite face feature is available only when you insert a memory card into the camera.

- 1 In Playback mode, press **[MENU]**.
- 2 Select → **Face List Edit** → **Edit Ranking**.
- 3 Select a face from the list, and then press **[OK]**.

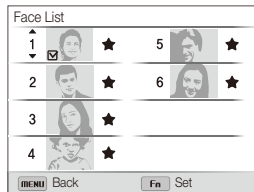

- 4 Press **[DISP/♥]** to change the ranking of the face, and then press **[Fn]**.

Deleting favorite faces

You can delete your favorite faces. The favorite face feature is available only when you insert a memory card into the camera.

- 1 In Playback mode, press **[MENU]**.
- 2 Select  → **Face List Edit** → **Delete**.
- 3 Select a face, and then press **[OK]**.
- 4 Press **[Fn]**.
- 5 When the pop-up message appears, select **Yes**.

Viewing files as a folder

Photos captured in a High-speed burst mode or in Precapture mode appear as a folder.

- 1 In Playback mode, press  to scroll to a desired folder.
 - The camera will automatically play back photos in the folder.

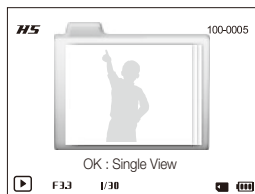

- 2 Press **[OK]** to open the folder.
- 3 Press  to scroll through files.
- 4 Press **[OK]** to return to Playback mode.



You cannot edit a photo while viewing a folder. To edit a photo in a folder, press **[OK]** to open the folder, and then scroll to the photo.

Viewing files by category in Smart Album

View files by category, such as date, face, or file type.

- 1 In Playback mode, rotate **[Zoom]** to the left.
- 2 Press **[MENU]**.
- 3 Select a category.

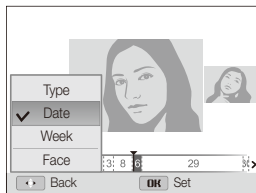

Option	Description
Type	View files by the file type.
Date	View files by the date they were saved.
Week	View files by the day of the week they were saved.
Face	View files by recognized faces and favorite faces. (Up to 20 people)

- 4 Press **[←/⏪]** to scroll through files.
 - Press and hold **[←/⏪]** to scroll through files quickly.
- 5 Press **[OK]** to return to the normal view.



It may take some time for the camera to open Smart Album, change the category, or reorganize files.

Viewing files as thumbnails

Scan thumbnails of files.

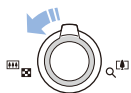

In Playback mode, rotate **[Zoom]** to the left to view thumbnails (3 at a time). Rotate **[Zoom]** to the left once or twice more to display more thumbnails (9 or 20 at a time). Rotate **[Zoom]** to the right to return to the previous view.

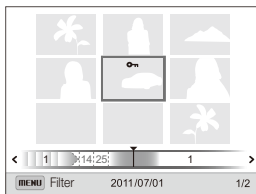

To	Description
Scroll through files	Press [DISP] .
Delete files	Press [Fn] , and then select Yes .



When you scroll to a video file or folder in the thumbnails view, the camera will automatically play back the video or the photos in the folder.

Protecting files

Protect your files from accidental deletion.

- In Playback mode, press **[MENU]**.
- Select → **Protect** → **Select**.
 - To protect all files, select **All** → **Lock**.
- Scroll to the file you want to protect, and then press **[OK]**.
 - Press **[OK]** again to cancel your selection.

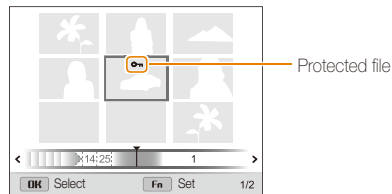

- Press **[Fn]**.



You cannot delete or rotate a protected file.

Deleting files

Select files to delete in Playback mode.

Deleting a single file

You can select one file, and then delete it.

- 1 In Playback mode, select a file, and then press **[Fn]**.
- 2 When the pop-up message appears, select **Yes**.



- When viewing files in Smart Album or thumbnails view, press **[Fn]** to delete a file.
- While viewing files as a folder, press **[Fn]** to delete all photos in the folder.
- To delete a specific photo in a folder, open the folder, select a file, and then press **[Fn]**.

Deleting multiple files

You can select multiple files, and then delete them at once.

- 1 In Playback mode, press **[Fn]**.
- 2 When the pop-up message appears, select **Multiple Delete**.
 - You can also delete multiple files in Playback mode by pressing **[MENU]**, and then selecting  → **Delete** → **Select**.
- 3 Scroll to each file you want to delete, and then press **[OK]**.
 - Press **[OK]** again to cancel your selection.
- 4 Press **[Fn]**.
- 5 When the pop-up message appears, select **Yes**.

Deleting all files

You can select all files, and then delete them at once.

- 1 In Playback mode, press **[MENU]**.
- 2 Select  → **Delete** → **All**.
- 3 When the pop-up message appears, select **Yes**.

Copying files to a memory card

Copy files from the internal memory to a memory card.

- 1 In Playback mode, press **[MENU]**.
- 2 Select  → **Copy to Card**.
- 3 Select **Yes**.

Viewing photos

Enlarge part of a photo or view photos as a slide show.

Enlarging a photo



In Playback mode, rotate **[Zoom]** to the right to enlarge a portion of the photo. Rotate **[Zoom]** to the left to zoom out.

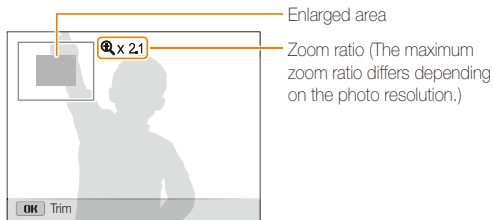

To	Description
Move the enlarged area	Press [DISP/🌺/🔍/📷] .
Trim the enlarged photo	Press [OK] , and then select Yes . (It will be saved as a new file.)



When you view photos that were captured by another camera, the zoom ratio may differ.

Viewing panoramic photos

View photos captured in Panorama mode.

- 1 In Playback mode, press **[🔍/📷]** to scroll to a desired panoramic photo.
 - The entire panoramic photo appears on the screen.
- 2 Press **[OK]**.
 - The camera automatically scrolls through the photo horizontally or vertically, depending on the direction you moved when capturing the photo. The camera then switches to Playback mode.
 - While playing back a panoramic photo, press **[OK]** to pause or resume.
 - When playback of a panoramic photo pauses, press **[DISP/🌺/🔍/📷]** to move the photo horizontally or vertically, depending on the direction you moved when capturing the photo.
- 3 Press **[MENU]** to return to Playback mode.



- The camera automatically scrolls through the panoramic photo only when the longest edge of the photo is two or more times longer than the shortest edge.
- On your camera's display, a photo captured in 3D Panorama mode appears as a 2D panoramic photo. To see the 3D effect, connect your camera to a 3D TV or 3D monitor. (p. 96)

Playing a slide show

Apply effects and audio to a slide show of your photos. The slide show function does not work for videos.

- 1 In Playback mode, press **[MENU]**.
- 2 Select .
- 3 Select a slide show effect option.
 - Skip to step 4 to start a slide show with no effects.

* Default

Option	Description
Start	Set whether or not to repeat the slide show. (Play, Repeat)
Images	Set the photos you want to view as a slide show. <ul style="list-style-type: none"> • All*: View all photos in a slide show. • Date: View photos captured on a specific date in a slide show. • Select: View selected photos in a slide show.
Interval	<ul style="list-style-type: none"> • Set the interval between photos. (1 sec*, 3 sec, 5 sec, 10 sec) • You must set the Effect option to Off to set the interval.

* Default

Option	Description
Effect	<ul style="list-style-type: none"> • Set a scene change effect between photos. (Off*, Calm, Shine, Relax, Lively, Sweet) • Select Off to cancel effects. • When you use the Effect option, the interval between photos will be set to 3 seconds.
Music	Set background audio.

- 4 Select **Start** → **Play**.
 - Select **Repeat** to loop the slide show.
- 5 View the slide show.
 - Press **[OK]** to pause the slide show.
 - Press **[OK]** again to resume the slide show.



Press **[OK]**, and then press **[⏏/⏪]** to stop the slide show and return to Playback mode.

Playing a video

In Playback mode, you can view a video, and then capture or trim parts of the playing video. You can save the captured or trimmed segments as new files.

- 1 In Playback mode, select a video, and then press **[OK]**.
- 2 View the video.

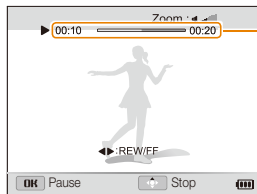

Current playback time/
Video length

Trimming a video

- 1 While viewing a video, press **[OK]** at the point where you want the trimming to begin.
- 2 Rotate **[Zoom]** to the right, and then press **[OK]**.
- 3 Press **[OK]** at the point where you want the trimming to end.
- 4 Rotate **[Zoom]** to the right.
- 5 When the pop-up message appears, select **Yes**.



- The original video should be at least 10 seconds long.
- The camera will save the edited video as a new file.

To	Description
Scan backward	Press [↶] . Each time you press [↶] , you change the scan speed in this order: 2X, 4X, 8X.
Pause or resume playback	Press [OK] .
Scan forward	Press [↷] . Each time you press [↷] , you change the scan speed in this order: 2X, 4X, 8X.
Adjust the volume level	Rotate [Zoom] to the left or right.

Capturing an image from video

- 1 While viewing a video, press **[OK]** at the point where you want to capture an image.
- 2 Press **[📷]**.



- The resolution of the captured image will be the same as the original video.
- The captured image is saved as a new file.

Using the Creative Movie Maker mode



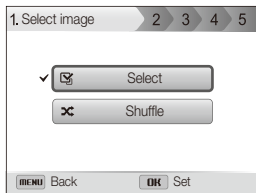

In Creative Movie Maker mode, you can easily make movies from the photos and videos stored on your memory card.

Making a movie with the Creative Movie Maker

- 1 In Playback mode, press **[MENU]**.
- 2 Select  → **Creative Movie Maker**.
- 3 Select **+ Movie Creation**.
- 4 Select **Select**, and then select files.
 - You must select at least 2 files.
 - If you select a folder, every photo in the folder will be selected.
 - If you select a  video, every photo captured while recording the video will be selected.
 - Select **Shuffle** to let the camera select photos and videos randomly. The movie cannot exceed 2 minutes 30 seconds in length.



-  You cannot select photos captured in Panorama mode, videos made in Creative Movie Maker mode, videos recorded with some Smart Filter effects (**Miniature, Vignetting, Half Tone Dot, Sketch, or Fish-eye**), or some high-speed videos (**440fps**).
- You can select up to 60 photos and 10 videos.

- 5 Press **[Fn]** to confirm the selection.
- 6 Press  to select **Theme**, and then select a theme.
- 7 Press  to select **Music**, and then select music.
- 8 Press  to select **Movie Size**, and then select a movie size.
- 9 Press  to select **Creation**, and then select **Creation Start**.
 - If your camera does not have enough available memory to store the movie, you cannot select **Creation Start**. Delete files from the memory card to make more memory available. (p. 81)
 - If the pop-up message appears when you select **Creation Start**, select a smaller movie size in **Movie Size** option.
 - The video rendering may take longer depending on the number and size of selected files.
 - Press **[MENU]** to cancel the video rendering.

View a movie made in the Creative Movie Maker mode

- 1 In Playback mode, press **[MENU]**.
- 2 Select  → **Creative Movie Maker**.
- 3 Press **[DISP/♥]** to select a movie.
- 4 Press **[OK]** to play the movie.



To view the movie in Playback mode, press . (p. 76)

Editing a photo

Learn how to edit photos.

- The camera will save edited photos as new files.
- When you edit photos, the camera will automatically convert them to a lower resolution. Photos that you rotate or resize manually are not automatically converted to a lower resolution.

Resizing photos

Change the size of a photo and save it as a new file.

- 1 In Playback mode, select a photo, and then press **[MENU]**.
- 2 Select  → **Resize**.
- 3 Select an option.

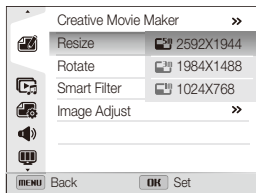

- Available resize options differ depending on the original size of the photo.

Rotating a photo

- 1 In Playback mode, select a photo, and then press **[MENU]**.
- 2 Select  → **Rotate**.
- 3 Select an option.

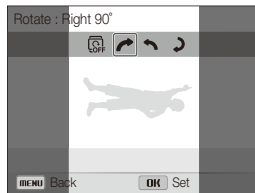





- The camera will overwrite the original file.



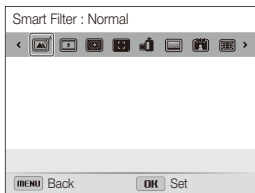







Applying Smart Filter effects

Apply special effects to your photos.

- 1 In Playback mode, select a photo, and then press **[MENU]**.
- 2 Select  → **Smart Filter**.
- 3 Select an effect.



Icon	Description
	Normal: No effect
	Miniature: Apply a tilt-shift effect to make the subject appear in miniature.
	Vignetting: Apply the retro-looking colors, high contrast, and strong vignette effect of Lomo cameras.
	Soft Focus: Hide facial imperfections or apply dreamy effects.

Icon	Description
	Old Film: Apply a vintage film effect.
	Half Tone Dot: Apply a halftone effect.
	Sketch: Apply a pen sketch effect.
	Fish-eye: Distort close objects to imitate the visual effect of a fisheye lens.
	Classic: Apply a black and white effect.
	Retro: Apply a sepia tone effect.
	Oil Painting: Apply an oil painting effect.
	Cartoon: Apply a cartoon painting effect.
	Ink Painting: Apply a watercolor painting effect.
	Cross Filter: Add lines that radiate outward from bright objects to imitate the visual effect of a cross filter.
	Zooming Shot: Blur the edges of a photo to emphasize the subjects in the center.



Adjusting your photos

Learn how to correct the red-eye effect, adjust the skin tone, and adjust the brightness, contrast, or saturation. The camera will save an edited photo as a new file, but may convert it to a lower resolution.

Removing red-eye



- 1 In Playback mode, select a photo, and then press **[MENU]**.
- 2 Select  → **Image Adjust** → **Red-eye Fix**.
- 3 Press **[OK]** to save your settings.



Retouching faces

- 1 In Playback mode, select a photo, and then press **[MENU]**.
- 2 Select  → **Image Adjust** → **Face Retouch**.
- 3 Press .
- 4 Press  to adjust the skin tone.
 - As the number increases, the skin tone becomes brighter.
- 5 Press **[OK]** to save your settings.

Adjusting brightness, contrast, or saturation

- 1 In Playback mode, select a photo, and then press **[MENU]**.
- 2 Select  → **Image Adjust**.
- 3 Select an adjusting option.

Icon	Description
	Brightness
	Contrast
	Saturation

- 4 Press .
- 5 Press / to adjust the option.
- 6 Press **[OK]** to save your settings.

Adding noise to the photo

- 1 In Playback mode, select a photo, and then press **[MENU]**.
- 2 Select  → **Image Adjust** → **Add Noise**.
- 3 Press **[OK]** to save.

Creating a print order (DPOF)

Select photos to print and save print options in the Digital Print Order Format (DPOF). This information is saved in the MISC folder on your memory card for convenient printing on DPOF-compatible printers.

- 1 In Playback mode, press **[MENU]**.
- 2 Select  → **DPOF** → **Standard** → **Select**.
 - Select **All** to print all photos.

- 3 Scroll to a photo you want to print, rotate **[Zoom]** to the left or right to select the number of copies, and then press **[Fn]**.
 - If you select **All**, press **[DISP/🌸]** to select the number of copies, and then press **[OK]**.
- 4 Press **[MENU]**.
- 5 Select **🖨️** → **DPOF** → **Size** → **Select**.
 - Select **All** to choose the print size for all photos.
- 6 Scroll to a photo you want to print, rotate **[Zoom]** to the left or right to select the print size, and then press **[Fn]**.
 - If you select **All**, press **[DISP/🌸]** to select the print size, and then press **[OK]**.

Printing photos as thumbnails

Print photos as thumbnails to check all the photos at once.

- 1 In Playback mode, press **[MENU]**.
- 2 Select **🖨️** → **DPOF** → **Index**.
- 3 When the pop-up message appears, select **Yes**.



- You can take the memory card to a print shop that supports DPOF (Digital Print Order Format) or you can print photos directly through a DPOF-compatible printer at home.
- Photos with dimensions that are wider than the paper may be cut off on the left and right edges. Ensure that your photo dimensions are compatible with the paper you select.
- You cannot set DPOF options for photos stored in the internal memory.
- If you specify the print size, you can print photos only with DPOF 1.1-compatible printers.

Viewing files on a TV, HDTV, or 3D TV

Play back photos or videos by connecting your camera to a TV with the A/V cable.

- 1 In Shooting or Playback mode, press **[MENU]**.
- 2 Select  → **Video Out**.
- 3 Select the video signal output for your country or region.
(p. 109)
- 4 Turn off your camera and TV.
- 5 Connect your camera to your TV with the A/V cable.
- 6 Turn on your TV, and then select the A/V video source with the TV remote control.
- 7 Turn on your camera.
 - The camera automatically enters into Playback mode when you connect it to a TV.
- 8 View photos or play videos using the camera buttons.

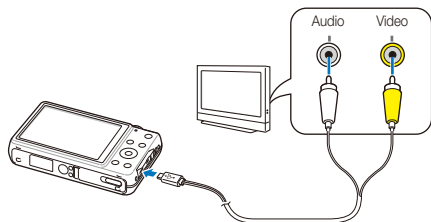

- Depending on the TV model, you may see some digital noise or part of an image may not appear.
- Images may not be centered on the TV screen depending on your TV settings.

Viewing files on an HDTV

You can view high-quality and uncompressed photos or videos on an HDTV using the optional HDMI cable. HDMI (High Definition Multimedia Interface) is supported by most HDTVs.

- 1 In Shooting or Playback mode, press **[MENU]**.
- 2 Select  → **HDMI Size**.
- 3 Select an HDMI resolution. (p. 109)
- 4 Turn off your camera and HDTV.
- 5 Connect your camera to your HDTV with the optional HDMI cable.

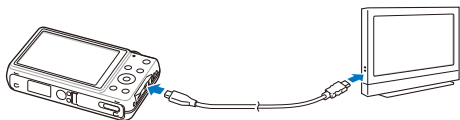

6 Turn on your camera.

- If you have an Anynet+ compatible Samsung HDTV and you have turned on your camera's Anynet+ function, the HDTV turns on automatically and displays the camera screen, while the camera automatically enters Playback mode.
- If you turn Anynet+ off in your camera, the HDTV does not turn on automatically.

7 View files using the buttons on your camera or a remote control of your HDTV.





- If your HDTV supports the Anynet+(CEC) profile, turn Anynet+ on in the camera's settings menu (p. 108) to control the camera and TV with the TV's remote control.
- Anynet+ lets you control all connected Samsung A/V devices with the TV remote control.
- The time it takes for the camera to connect to your HDTV may vary with the type of microSD or microSDHC card you use. A faster microSD or microSDHC card will not necessarily result in a faster HDMI transfer, because the main function of the card is to improve transfer rate during shooting.

Viewing files on a 3D TV

You can view photos captured in 3D Photo or 3D Panorama mode on a 3D TV.

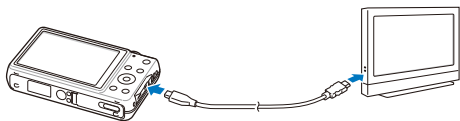
- 1 In Shooting or Playback mode, press **[MENU]**.
- 2 Select  → **HDMI Size**.
- 3 Select an HDMI resolution. (p. 109)
- 4 Turn off your camera and 3D TV.
- 5 Connect your camera to your 3D TV with the optional HDMI cable.



- 6 Turn on your camera.
 - If you have an Anynet+ compatible Samsung 3D TV and you have turned on your camera's Anynet+ function, the 3D TV turns on automatically and displays the camera screen, while the camera automatically enters Playback mode.
 - If you turn Anynet+ off in your camera, the 3D TV does not turn on automatically.
- 7 Press  to switch to **3D TV Mode**.
 - Press  again to switch to **2D TV Mode**.
- 8 Turn on your TV's 3D function.
 - Refer to your TV's user manual for more details.
- 9 View 3D photos with the buttons on your camera or your TV's remote control.



- You cannot view an MPO file in 3D effect on TVs that do not support the file format.
- Use proper 3D glasses when you view an MPO file on a 3D TV.



Do not view the 3D images captured by your camera on a 3D TV or 3D monitor for an extended period of time. It may cause unpleasant symptoms, such as eyestrain, fatigue, nausea, and more.

Transferring files to your Windows computer

Transfer files to your Windows computer, edit them with Intelli-studio, and upload them to the web.

Requirements

Item	Requirements
CPU	Intel® Core 2 Duo® 1.66 GHz or higher/ AMD Athlon™ X2 Dual-Core 2.2 GHz or higher
RAM	Minimum 512 MB RAM (1 GB or more recommended)
OS*	Windows XP SP2, Windows Vista, or Windows 7 (32-bit editions)
Hard disk capacity	250 MB or more (1 GB and above recommended)
Others	<ul style="list-style-type: none">• CD-ROM drive• 1024 X 768 pixels, 16-bit color display compatible monitor (1280 X 1024 pixels, 32-bit color display recommended)• USB 2.0 port• nVIDIA Geforce 7600GT or higher/ ATI X1600 series or higher• Microsoft DirectX 9.0c or higher

* The programs may not work properly on 64-bit editions of Windows XP, Windows Vista, and Windows 7.



- The requirements are recommendation only. Intelli-studio may not work properly even when the computer meets the requirements, depending on the condition of your computer.
- If your computer does not meet the requirements, videos may not play correctly or it may take longer to edit videos.
- Install DirectX 9.0c or above before you use Intelli-studio.
- Your computer must be running Windows XP, Windows Vista, or Windows 7 for you to connect the camera as a removable disk.





The manufacturer is not responsible for any damage that results from using unqualified computers such as a computer you assembled yourself.

Transferring files with Intelli-studio

Intelli-studio will start automatically when you connect the camera to your computer with the USB cable.

 The battery will charge while the camera is connected to a computer with the USB cable.

- 1 In Shooting or Playback mode, press **[MENU]**.
- 2 Select  → **PC Software** → **On**.
- 3 Turn off the camera.
- 4 Connect the camera to your computer with the USB cable.

 You must plug the small end of the USB cable into your camera. If the cable is reversed, it may damage your files. The manufacturer is not responsible for any loss of data.

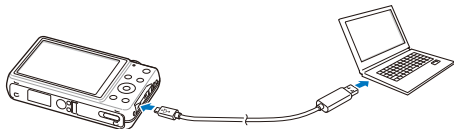

- 5 Turn on the camera.

- The computer recognizes the camera automatically and Intelli-studio launches automatically.

 If you set the USB option to **Select**, select **Computer** in the pop-up window.

- 6 Select a destination folder on your computer, and then select **Yes**.

- New files stored on the camera will automatically transfer to the selected folder.
- If your camera has no new files, the pop-up window for saving new files will not appear.

 For Windows Vista and Windows 7, select **Run iStudio.exe** from the Auto Play window to start Intelli-studio.

Using Intelli-studio

Intelli-studio is a built-in program that allows you to play back and edit files. For details, select **Help** → **Help** from the program toolbar.



- You can update the firmware of your camera by selecting **Web Support** → **Upgrade firmware for the connected device** from the program toolbar.
- If you install Intelli-studio on your computer, the program will launch more quickly. To install the program, select **Tool** → **Install Intelli-studio on PC**.
- You cannot edit files directly on the camera. Transfer files to a folder on your computer before editing.
- Intelli-studio supports the following formats:
 - Videos: MP4 (Video: H.264, Audio: AAC), WMV (WMV 7/8/9), AVI (MJPEG)
 - Photos: JPG, GIF, BMP, PNG, TIFF

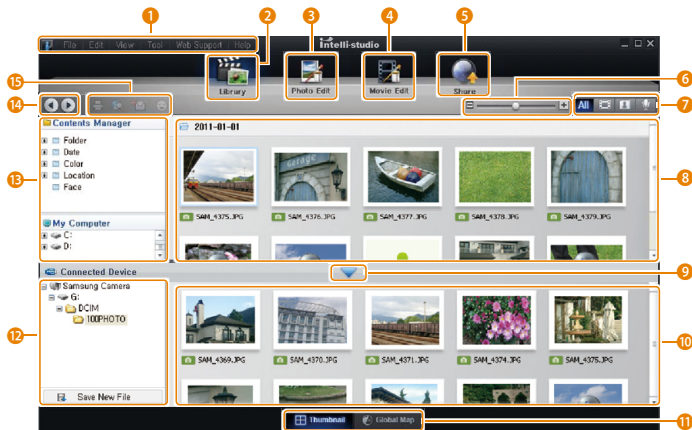

No.	Description
1	Open menus.
2	Display files in the selected folder.
3	Switch to the Photo edit mode.
4	Switch to the Video edit mode.
5	Switch to the Sharing mode (to send files by email or upload files to websites, such as Flickr or YouTube).
6	Enlarge or reduce the thumbnails in the list.
7	Select a file type.
8	View files in the selected folder on your computer.
9	Show or hide files on the connected camera.
10	View files in the selected folder on the camera.
11	View files as thumbnails or on a map.
12	Browse folders stored on the camera.
13	Browse folders stored on your computer.
14	Move to the previous or next folder.
15	Print files, view files on a map, store files in My Folder, or register faces.

Transferring files by connecting the camera as a removable disk

Connect the camera to your computer as a removable disk.

- 1 In Shooting or Playback mode, press **[MENU]**.
- 2 Select **⚙️** → **PC Software** → **Off**.
- 3 Turn off the camera.
- 4 Connect the camera to your computer with the USB cable.



You must plug the small end of the USB cable into your camera. If the cable is reversed, it may damage your files. The manufacturer is not responsible for any loss of data.

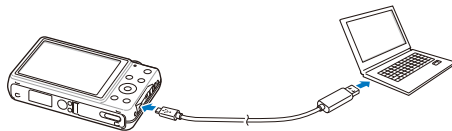

5 Turn on the camera.

- The computer recognizes the camera automatically.



If you set the USB option to **Select**, select **Computer** in the pop-up window.

6 On your computer, select **My Computer** → **Removable Disk** → **DCIM** → **100PHOTO**.

7 Drag or save files to your computer.

Disconnecting the camera (for Windows XP)

With Windows Vista and Windows 7, the methods for disconnecting the camera are similar.

- 1 If the status lamp on your camera is blinking, wait until it stops.
- 2 Click  on the tool bar at the bottom right of your computer screen.



- 3 Click the pop-up message.
- 4 Click the message box indicating safely removed.
- 5 Remove the USB cable.



The camera may not disconnect safely while Intelli-studio is running. End the program before disconnecting the camera.

Transferring files to your Mac computer

When you connect the camera to a Macintosh computer, the computer will automatically recognize the device. You can transfer files directly from the camera to the computer without installing any programs.



Mac OS 10.4 or later is supported.

1 Connect your camera to a Macintosh computer with the USB cable.



You must plug the small end of the USB cable into your camera. If the cable is reversed, it may damage your files. The manufacturer is not responsible for any loss of data.

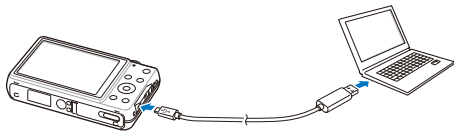

2 Turn on the camera.

- The computer recognizes the camera automatically and displays a removable disk icon.



If you set the USB option to **Select**, select **Computer** in the pop-up window.

3 Double-click the removable disk icon.

4 Drag or save files to your computer.

Printing photos with a PictBridge photo printer

Print photos with a PictBridge-compatible printer by connecting your camera directly to the printer.

- 1 In Shooting or Playback mode, press **[MENU]**.
- 2 Select  → **USB** → **Printer**.
- 3 Turn on the printer, and then connect your camera to the printer with the USB cable.

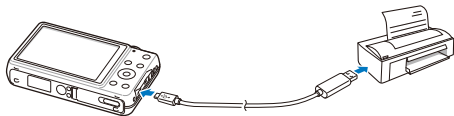

- 4 If the camera is off, press **[POWER]** or **[▶]** to turn it on.
 - The printer recognizes the camera automatically.
- 5 Press **[⚡/🔍]** to select a file to print.
 - Press **[MENU]** to set printing options. See "Configuring print settings."
- 6 Press **[OK]** to print.
 - Printing starts. Press **[⚡]** to cancel printing.

Configuring print settings

Press **[MENU]** to configure print settings.

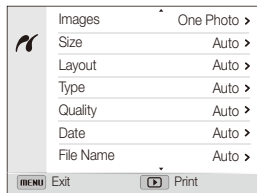

Option	Description
Images	Select whether to print the current photo or all photos.
Size	Set the print size.
Layout	Set the number of photos to be printed on a single sheet of paper.
Type	Set the type of paper.
Quality	Set the print quality.
Date	Set to print the date.
File Name	Set to print the file name.
Reset	Reset settings to their default values.



Some options may not be supported by some printers.

Settings

Refer to options to configure your camera's settings.

Settings menu	105
Accessing the settings menu	105
Sound	106
Display	106
Settings	107



Settings menu

Learn to configure your camera's settings.

Accessing the settings menu

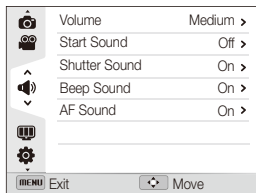
- 1 In Shooting or Playback mode, press **[MENU]**.
- 2 Select a menu.



Option	Description
	Sound: Set various camera sounds and the volume. (p. 106)
	Display: Customize the display settings. (p. 106)
	Settings: Customize the settings for the camera system. (p. 107)

- 3 Select an item.

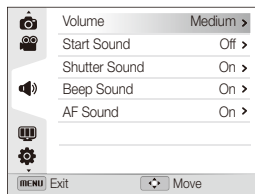

- 4 Select an option.

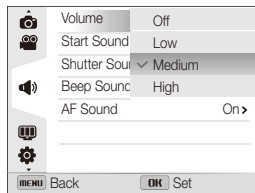

- 5 Press **[MENU]** to return to the previous screen.



Sound

* Default

Item	Description
Volume	Set the volume of any sound. (Off, Low, Medium*, High)
Start Sound	Set to emit a sound when you turn on your camera. (Off*, On)
Shutter Sound	Set to emit a sound when you press the shutter button. (Off, On*)
Beep Sound	Set to emit a sound when you press the buttons or switch modes. (Off, On*)
AF Sound	Set to emit a sound when you half-press the shutter button. (Off, On*)

Display

* Default

Item	Description
Function Description	Display a brief description of an option or a menu. (Off, On*)
Grid Line	Select a guide to help you compose a scene. (Off*, 3 X 3, 2 X 2, Cross, Diagonal)
Date/Time Display	Set whether or not to display the date and time on the camera's display. (Off*, On)
Display Brightness	Adjust the brightness of the screen. (Auto*, Dark, Normal, Bright)  Normal is fixed in Playback mode even if you have selected Auto.
Quick View	Set the duration for reviewing a captured image before returning to the Shooting mode. (Off, 0.5 sec*, 1 sec, 3 sec)
Power Save	If you perform no operations for 30 seconds, the camera automatically switches to Power save mode. (Off*, On)  <ul style="list-style-type: none"> In Power save mode, press any button other than [POWER] to resume using the camera. Even if you do not set the Power save mode, the screen will dim 30 seconds after the last operation to save power.

Settings



Item	Description
Language	Set a language for the display text.
Time Zone	Set the time zone for your location. When you travel to another country, select Visit , and then select the appropriate time zone. (Home* , Visit)
Date/Time Set	Set the date and time.
Date Type	Set a date format. (YYYY/MM/DD*, MM/DD/YYYY, DD/MM/YYYY)  The default date type may differ depending on the language selected.

* Default

* Default

Item	Description
File No.	<p>Specify how to name files.</p> <ul style="list-style-type: none"> • Reset: Set the file number to start from 0001 when you insert a new memory card, format a memory card, or delete all files. • Series*: Set the file number to resume from the previous file number when you insert a new memory card, format a memory card, or delete all files. <p> • The default name of the first folder is 100PHOTO and the default name of the first file is SAM_0001.</p> <ul style="list-style-type: none"> • The file number increases one at a time from SAM_0001 to SAM_9999. • The folder number increases one at a time from 100PHOTO to 999PHOTO. • The maximum number of files that can be stored in one folder is 1,000. • The camera defines file names according to the Design rule for Camera File system (DCF) standard. If you intentionally change file names, the camera may not play back the files.

* Default

Item	Description
Imprint	<p>Set whether or not to display the date and time on captured photos. (Off, Date, Date & Time)</p>  <ul style="list-style-type: none"> The date and time will be displayed on the bottom right corner of the photo. Some printer models may not print the date and time properly. The camera will not display the date and time if: <ul style="list-style-type: none"> - you select Text in RAW mode - you select Panorama mode
Auto Power Off	<p>Set the camera to automatically turn off when you perform no operations for a specified period. (Off, 1 min, 3 min*, 5 min, 10 min)</p>  <ul style="list-style-type: none"> Your settings will not change when you replace the battery. The camera will not automatically turn off when the camera is connected to a computer or printer, and when you are playing a slide show or videos.
AF Lamp	<p>Set a light to automatically turn on in dark places to help you focus. (Off, On*)</p>

* Default

Item	Description
Format	<p>Format the internal memory and the memory card (formatting will delete all files, including protected files). (No, Yes)</p>  <p>Errors can occur if you use a memory card formatted by another brand of camera, a memory card reader, or a computer. Please format memory cards in the camera before using them to capture photos.</p>
Reset	<p>Reset menus and shooting options (date and time, language, and video output settings will not be reset). (No, Yes)</p>
Anynet+ (HDMI-CEC)	<p>Turn on to control the camera with a TV remote control when you connect it to an HDTV that supports the Anynet+(CEC) profile.</p> <ul style="list-style-type: none"> Off: View files without using an HDTV remote control. On*: Control the camera with an HDTV remote control.

Item	Description	* Default
HDMI Size	<p>Set the resolution of photos when the camera plays back files on an HDTV via the HDMI cable. (NTSC: 1080i*, 720p, 480p/ PAL: 1080i*, 720p, 576p)</p>  <ul style="list-style-type: none"> If the HDTV does not support the selected resolution, the HDTV automatically selects the next lower resolution. If you select 480p or 576p, the playback menus and Smart Album will not be available when you connect the camera to a TV. 	
Video Out	<p>Set the video signal output for your region.</p> <ul style="list-style-type: none"> NTSC: USA, Canada, Japan, Korea, Taiwan, Mexico PAL (supports only BDGHI): Australia, Austria, Belgium, China, Denmark, England, Finland, Germany, Italy, Kuwait, Malaysia, Netherlands, New Zealand, Norway, Singapore, Spain, Sweden, Switzerland, Thailand 	

Item	Description	* Default
USB	<p>Select the mode to use when you connect the camera to a computer or printer with a USB cable.</p> <ul style="list-style-type: none"> Select: Manually select the USB mode when you connect your camera to a device. Computer*: Connect your camera to a computer for transferring files. Printer: Connect your camera to a printer for printing files. 	
PC Software	<p>Set Intelli-studio to launch automatically when you connect your camera to your computer. (Off, On*)</p>	

Appendixes

Get information about error messages, specifications, and maintenance.

Error messages	111
Camera maintenance	112
Cleaning your camera	112
Using or storing the camera	113
About memory cards	114
About the battery	117
Before contacting a service center	121
Camera specifications	124
Glossary	128
FCC notice	133
Index	134

Error messages

When the following error messages appear, try these remedies.

Error message	Suggested remedies
Card Error	<ul style="list-style-type: none">• Turn off your camera, and then turn it on again.• Remove your memory card, and then insert it again.• Format your memory card.
Card not supported.	The inserted memory card is not supported by your camera. Insert a microSD or microSDHC memory card.
DCF Full Error	File names do not match the DCF standard. Transfer the files from the memory card to your computer and format the card. Then, open the Settings menu and select File No. → Reset. (p. 107)

Error message	Suggested remedies
File Error	Delete the damaged file or contact a service center.
File system not supported.	Your camera does not support the FAT file structure of the inserted memory card. Format the memory card on the camera.
Low Battery	Insert a charged battery or recharge the battery.
Memory Full	Delete unnecessary files or insert a new memory card.
No Image File	Capture photos or insert a memory card that contains some photos.

Camera maintenance

Cleaning your camera

Camera lens and display

Use a blower brush to remove dust and wipe the lens gently with a soft cloth. If any dust remains, apply lens cleaning liquid to a piece of lens cleaning paper and wipe gently.

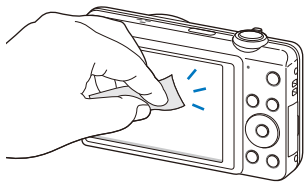
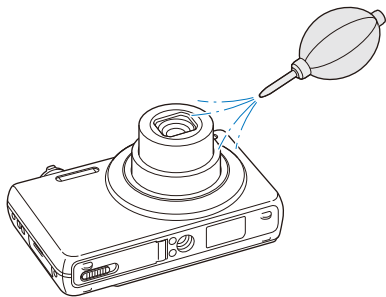

Camera body

Wipe gently with a soft, dry cloth.

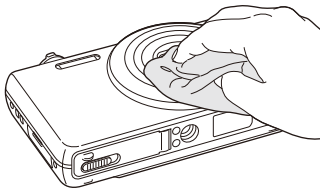

- Never use benzene, thinners, or alcohol to clean the device. These solutions can damage the camera or cause it to malfunction.
- Do not press on the lens cover or use a blower brush on the lens cover.

Using or storing the camera

Inappropriate places to use or store the camera

- Avoid exposing the camera to very cold or very hot temperatures.
- Avoid using your camera in areas with extremely high humidity, or where the humidity changes drastically.
- Avoid exposing the camera to direct sunlight and storing it in hot, poorly-ventilated areas, such as in a car during summer time.
- Protect your camera and the display from impact, rough handling, and excessive vibration to avoid serious damage.
- Avoid using or storing your camera in dusty, dirty, humid, or poorly-ventilated areas to prevent damage to moving parts and internal components.
- Do not use your camera near fuels, combustibles, or flammable chemicals. Do not store or carry flammable liquids, gases, or explosive materials in the same compartment as the camera or its accessories.
- Do not store the camera where there are mothballs.

Using on beaches or shores

- Protect your camera from sand and dirt when you use it on beaches or in other similar areas.
- Your camera is not waterproof. Do not handle the battery, adapter, or memory card with wet hands. Operating the camera with wet hands may cause damage to your camera.

Storing for extended period of time

- When you store the camera for an extended period, place it in a sealed container with an absorbent material, such as silica gel.
- Remove the batteries from your camera when storing it for an extended period. Installed batteries may leak or corrode over time and cause serious damage to your camera.
- Over time, unused batteries will discharge and must be recharged before use.

Using the camera with caution in humid environments

When you transfer the camera from a cold environment to a warm one, condensation can form on the lens or internal components of the camera. In this situation, turn off the camera and wait for at least 1 hour. If condensation forms on the memory card, remove the memory card from the camera and wait until all moisture has evaporated before reinserting it.

Other cautions

- Do not swing your camera by the strap. This may cause injury to yourself or others or damage to your camera.
- Do not paint your camera, as paint can clog moving parts and prevent proper operation.
- Turn off the camera when not using it.
- Your camera consists of delicate parts. Avoid impacts to the camera.
- Protect the display from external force by keeping it in the case when not in use. Protect the camera from scratches by keeping it away from sand, sharp implements, or loose change.
- Do not expose the lens to direct sunlight, as this may discolor the image sensor or cause it to malfunction.
- Protect your lens from fingerprints and scratches. Clean your lens with a soft, clean, debris-free lens cloth.
- The camera may turn off if impacted from the outside. This is to protect the memory card. Turn on the camera to use it again.
- While you use the camera, it may heat up. This is normal and should not affect your camera's lifespan or performance.
- When you use the camera in low temperatures, it may take some time to turn on, the color of the display may be changed temporarily, or after-images may appear. These conditions are not malfunctions and they will correct themselves when the camera is returned to normal temperatures.

- Paint or metal on the outside of the camera may cause allergies, itchy skin, eczema, or swelling for people with sensitive skin. If you experience any of these symptoms, stop using the camera immediately and consult a doctor.
- Do not insert foreign objects into any of your camera's compartments, slots, or access points. Damage due to improper use may not be covered by your warranty.
- Do not allow unqualified personnel to service the camera or attempt to service the camera yourself. Any damage that results from unqualified service is not covered by your warranty.

About memory cards

Supported memory cards

Your camera supports microSD (Secure Digital) or microSDHC (Secure Digital High Capacity) memory cards.

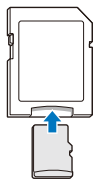









To read data with a PC or memory card reader, insert the memory card into a memory card adapter.

Memory card capacity

The memory capacity may differ depending on shooting scenes or shooting conditions. These capacities are based on a 1 GB microSD card:

Photo

Size	Super Fine	Fine	Normal
 14m	133	165	215
 12m	149	184	240
 10m	183	225	292
 10m	182	224	291
 5m	341	413	523
 3m	533	634	783
 2m	699	820	991
 1m	1285	1432	1617

Video

Size	440fps	250fps	30fps
FULL HD 1920X1080	-	-	Approx. 08' 30"
HD 1280X720	-	-	Approx. 13' 11"
VGA 640X480	-	-	Approx. 26' 10"
400 400X304	-	Approx. 21' 59"	-
240 240X176	Approx. 14' 45"	-	-

* The figures above are measured without using the zoom function. Available recording time may vary if you use the zoom. Several videos were recorded in succession to determine the total recording time.

Cautions when using memory cards

- Avoid memory cards to very cold or very hot temperatures (below 0 °C/32 °F or above 40 °C/104 °F). Extreme temperatures can cause memory cards to malfunction.
 - Insert a memory card in the correct direction. Inserting a memory card in the wrong direction may damage your camera and memory card.
 - Do not use memory cards that have been formatted by other cameras or by a computer. Reformat the memory card with your camera.
 - Turn off the camera when you insert or remove the memory card.
 - Do not remove the memory card or turn off your camera while the lamp is blinking, as this may damage your data.
 - When the lifespan of a memory card has expired, you cannot store any more photos on the card. Use a new memory card.
 - Do not bend, drop, or subject memory cards to heavy impact or pressure.
 - Avoid using or storing memory cards near strong magnetic fields.
 - Avoid using or keeping memory cards in areas with high temperature, high humidity, or corrosive substances.
- Prevent memory cards from making contact with liquids, dirt, or foreign substances. If dirty, wipe the memory card clean with a soft cloth before you insert the memory card in your camera.
 - Do not allow liquids, dirt, or foreign substances to come in contact with memory cards or the memory card slot. Doing so may cause memory cards or the camera to malfunction.
 - When you carry a memory card, use a case to protect the card from electrostatic discharges.
 - Transfer important data to other media, such as a hard disk, CD, or DVD.
 - When you use the camera for an extended period, the memory card may become warm. This is normal and does not indicate a malfunction.



The manufacturer is not responsible for any loss of data.

About the battery

Use only Samsung-approved batteries.

Battery specifications

Specification	Description
Model	BP70A
Type	Lithium-ion battery
Cell capacity	740 mAh (min. 700 mAh)
Voltage	3.7 V
Charging time* (when the camera is switched off)	Approximately 150 min

* Charging the battery by connecting it to a computer may take longer.

Battery life

Average shooting time/ Number of photos		Test conditions (when the battery is fully charged)
Photos	Approximately 90 min/ Approximately 180 photos	<p>The battery life was measured under the following conditions: in Cp mode, in darkness, FHD resolution, Fine quality, OIS on.</p> <ol style="list-style-type: none"> 1. Set the flash option to Fill in, take a single shot, and zoom in or out. 2. Set the flash option to Off, take a single shot, and zoom in or out. 3. Perform steps 1 and 2, waiting 30 seconds between each step. Repeat the process for 5 minutes, and then turn off the camera for 1 minute. 4. Repeat steps 1 to 3.
Videos	Approximately 50 min	Record videos at FULL HD resolution and 30 FPS.

- The figures above are measured by Samsung's standards. Your results may differ, depending on your actual usage.
- Several videos were recorded in succession to determine the total recording time.

Low battery message

When the battery has fully discharged, the battery icon will turn red and the "Low Battery" message will appear.

Notes about using the battery

- Avoid exposing batteries to very cold or very hot temperatures (below 0 °C/32 °F or above 40 °C/104 °F). Extreme temperatures can reduce the charging capacity of your batteries.
- When you use the camera for an extended period, the area around the battery chamber may become warm. This does not affect the normal use of the camera.
- Do not pull the power supply cord to disconnect the plug from the power outlet, as this may cause a fire or electric shock.
- In temperatures below 0 °C/32 °F, battery capacity and battery life may decrease.
- Battery capacity may decrease in low temperatures but will return to normal in milder temperatures.

Cautions about using the battery

Protect batteries, chargers, and memory cards from damage

Prevent batteries from making contact with metal objects, as this can create a connection between the + and – terminals of your battery and lead to temporary or permanent battery damage and may cause a fire or electric shock.

Notes about charging the battery

- If the indicator light is off, make sure that the battery is inserted correctly.
- If the camera is on while charging, the battery may not fully charge. Turn off the camera before charging the battery.
- Do not use your camera when you charge the battery. This may cause a fire or electric shock.
- Do not pull the power supply cord to disconnect the plug from the power outlet, as this may cause a fire or electric shock.
- Let the battery charge for at least 10 minutes before turning on the camera.
- If you connect the camera to an external power source while the battery is depleted, using some high energy-consuming functions will cause the camera to turn off. To use the camera normally, recharge the battery.

- Using the flash or recording videos depletes the battery quickly. Charge the battery until the red indicator light turns off.
- If the indicator light does not illuminate, reconnect the cable, or remove the battery and insert it again.
- Overcharging batteries may shorten battery life. After charging is finished, disconnect the cable from your camera.
- Do not bend or place heavy objects on the AC cable. Doing so may damage the cable.

Notes about charging with a computer connected

- Use only the provided USB cable.
- The battery may not charge when:
 - you use a USB hub
 - other USB devices are connected to your computer
 - you connect the cable to the port on the front side of your computer
 - the USB port of your computer does not support the power output standard (5 V, 500 mA)

Handling and disposing of batteries and chargers with care

- Never dispose of batteries in a fire. Follow all local regulations when you dispose of used batteries.
- Never place batteries or cameras on or in heating devices, such as microwave ovens, stoves, or radiators. Batteries may explode when they are overheated.



Personal injury or death can occur if the battery is handled carelessly or improperly. For your safety, follow these instructions for proper battery handling:

- The battery can ignite or explode if not handled properly. If you notice any deformities, cracks, or other abnormalities in the battery, immediately discontinue use of the battery and contact a service center.
- Use only authentic, manufacturer-recommended battery chargers and adapters and charge the battery only by the methods described in this user manual.
- Do not place the battery near heating devices or expose it to excessively warm environments, such as the inside of an enclosed car in the summertime.
- Do not place the battery in a microwave oven.
- Avoid storing or using the battery in hot, humid places, such as spas or shower enclosures.
- Do not rest the device on flammable surfaces, such as bedding, carpets, or electric blankets for a prolonged period.
- When the device is switched on, do not leave it in any confined space for a prolonged period.
- Do not allow battery terminals to come in contact with metallic objects, such as necklaces, coins, keys, or watches.
- Use only authentic, manufacturer-recommended, Lithium-ion replacement batteries.

- Do not disassemble or puncture the battery with any sharp object.
- Avoid exposing the battery to high pressure or crushing forces.
- Avoid exposing the battery to major impacts, such as dropping it from high places.
- Do not expose the battery to temperatures of 60 °C (140 °F) or above.
- Do not allow the battery to come in contact with moisture or liquids.
- Do not expose the battery to sources of excessive heat such as sunshine, fire or the like.

Disposal guidelines

- Dispose of the battery with care.
- Do not dispose of the battery in a fire.
- Disposal regulations may differ by country or region. Dispose of the battery in accordance with all local and federal regulations.

Guidelines for charging the battery

Charge the battery only by the method described in this user manual. The battery can ignite or explode if not charged properly.

Before contacting a service center

If you are having trouble with your camera, try these troubleshooting procedures before you contact a service center. If you have attempted the suggested remedy and are still having problems with your device, contact your local dealer or service center.

 When you leave your camera at a service center, be sure to also leave the other components that may have contributed to the malfunction, such as the memory card and battery.

Situation	Suggested remedies
Cannot turn on the camera	<ul style="list-style-type: none">• Ensure that the battery is inserted.• Ensure that the battery is inserted correctly. (p. 17)• Charge the battery.
The power turns off suddenly	<ul style="list-style-type: none">• Charge the battery.• Your camera may be in Power save mode. (p. 106)• The camera may turn off to prevent the memory card from being damaged due to an impact. Turn on your camera again.
The camera is losing battery power quickly	<ul style="list-style-type: none">• The battery may lose power more quickly in low temperatures (below 0 °C/32 °F). Keep the battery warm by putting it into your pocket.• Using the flash or recording videos depletes the battery quickly. Recharge if needed.• Batteries are consumable parts that must be replaced over time. Get a new battery if the battery life is diminishing quickly.

Situation	Suggested remedies
Cannot capture photos	<ul style="list-style-type: none">• There is no space on the memory card. Delete unnecessary files or insert a new card.• Format the memory card.• The memory card is defective. Get a new memory card.• Make sure that the camera is switched on.• Charge the battery.• Make sure that the battery is inserted correctly.
The camera freezes	Remove the battery and insert it again.
The camera heats up	While you use the camera, it may heat up. This is normal and should not affect your camera's lifespan or performance.
The flash does not work	<ul style="list-style-type: none">• The flash option may be set to Off. (p. 55)• You cannot use the flash in some modes.

Situation	Suggested remedies
The flash fires unexpectedly	The flash may fire due to static electricity. The camera is not malfunctioning.
The date and time are incorrect	Set the date and time in the display settings. (p. 107)
The display or buttons do not work	Remove the battery, and then insert it again.
The camera display responds poorly	If you use your camera at very low temperatures, it may cause the camera screen to malfunction or discolor. For better performance of your camera screen, use your camera in moderate temperatures.
The memory card has an error	<ul style="list-style-type: none"> • Turn off your camera, and then turn it on again. • Remove your memory card, and then insert it again. • Format your memory card. See "Cautions when using memory cards" for more detail. (p. 116)
Cannot play back files	If you change the name of a file, your camera may not play the file (the name of the file should meet the DCF standard). If you encounter this situation, play back the files on your computer.

Situation	Suggested remedies
The photo is blurry	<ul style="list-style-type: none"> • Make sure that the focus option you set is suitable for close-up shots. (p. 58) • Make sure that the lens is clean. If not, clean the lens. (p. 112) • Make sure that the subject is within range of the flash. (p. 125)
The colors in the photo do not match the actual scene	An incorrect White Balance can create unrealistic color. Select the proper White Balance option to suit the light source. (p. 68)
The photo is too bright	Your photo is overexposed. <ul style="list-style-type: none"> • Turn off the flash. (p. 55) • Adjust the ISO sensitivity. (p. 57) • Adjust the exposure value. (p. 66)
The photo is too dark	Your photo is underexposed. <ul style="list-style-type: none"> • Turn on the flash. (p. 55) • Adjust the ISO sensitivity. (p. 57) • Adjust the exposure value. (p. 66)

Situation	Suggested remedies
The TV does not display your photos	<ul style="list-style-type: none"> • Make sure that the camera is correctly connected to the TV with the A/V cable. • Make sure that your memory card contains photos.
Your computer does not recognize your camera	<ul style="list-style-type: none"> • Make sure that the USB cable is connected correctly. • Make sure that your camera is switched on. • Make sure that you are using a supported operating system.
Your computer disconnects the camera while transferring files	The file transmission may be interrupted by static electricity. Disconnect the USB cable and connect it again.
Your computer cannot play videos	Videos may not play on some video player programs. To play video files captured with your camera, install and use the Intelli-studio program on your computer. (p. 98)

Situation	Suggested remedies
Intelli-studio is not functioning properly	<ul style="list-style-type: none"> • End Intelli-studio and restart the program. • You cannot use Intelli-studio on Macintosh computers. • Make sure that PC Software is set to On in the settings menu. (p. 109) • Depending on your computer's specifications and environment, the program may not launch automatically. In this case, click Start → My Computer → Intelli-studio → iStudio.exe on your computer.

Camera specifications









Image sensor	
Type	1/2.3" (Approximately 7.76 mm) BSI CMOS
Effective pixels	Approximately 14.52 mega-pixels
Total pixels	Approximately 14.6 mega-pixels
Lens	
Focal length	Samsung Lens f = 4.7-23.5 mm (35 mm film equivalent: 26-130 mm)
F-stop range	F3.3 (W)-F5.9 (T)
Zoom	<ul style="list-style-type: none">• Still image mode: 1.0-5.0X (Optical zoom X Digital zoom: 20.0X, Smart zoom X Digital zoom: 20.0X)• Playback mode: 1.0-9.3X (depending on image size)
Display	
Type	TFT LCD
Feature	2.7" (6.9 cm) QVGA (230K)

Focusing			
Type	TTL auto focus (Multi AF, Center AF, Face Detection AF, Tracking AF, Smart Face Recognition AF)		
Range		Wide (W)	Tele (T)
	Normal (AF)	80 cm-infinity	150 cm-infinity
	Macro	5-80 cm	100-150 cm
	Auto Macro	5 cm-infinity	100 cm-infinity
Shutter speed			
<ul style="list-style-type: none">• Auto: 1/8-1/2,000 sec.• Program: 1-1/2,000 sec.• Night: 8-1/2,000 sec.			
Exposure			
Control	Program AE		
Metering	Multi, Spot, Center-weighted, Face Detection		
Compensation	±2EV (1/3 EV Step)		
ISO equivalent	Auto, ISO 100, ISO 200, ISO 400, ISO 800, ISO 1600, ISO 3200		

Flash	
Mode	Smart Auto, Auto, Red-eye, Fill in, Slow Sync, Off, Red-eye Fix, Flash EV
Range	<ul style="list-style-type: none"> • Wide: 0.2-3.4 m (ISO Auto) • Tele: 1.0-1.9 m (ISO Auto)
Recharging time	Approximately 4 sec.
Shake reduction	
DUAL IS [Optical Image Stabilization (OIS) + Digital Image Stabilization (DIS)]	
Effect	
Photo Shooting mode	<ul style="list-style-type: none"> • Smart Filter: Normal, Miniature, Vignetting, Soft Focus, Old Film, Half Tone Dot, Sketch, Fish-eye, Classic, Retro, Oil Painting, Cartoon, Ink Painting, Cross Filter • Image Adjust: Contrast, Sharpness, Saturation
Video Shooting mode	Smart Filter: Normal, Palette Effect 1, Palette Effect 2, Palette Effect 3, Palette Effect 4, Miniature, Vignetting, Half Tone Dot, Sketch, Fish-eye, Classic, Retro
White Balance	
Auto WB, Daylight, Cloudy, Fluorescent_H, Fluorescent_L, Tungsten, Custom Set	

Date Imprinting	
Off, Date, Date & Time	
Shooting	
Photos	<ul style="list-style-type: none"> • Modes: Smart Auto (Portrait, Night Portrait, Backlight Portrait, Night, Backlight, Landscape, White, Natural Green, Blue Sky, Sunset, Macro, Macro text, Macro Color, Tripod, Action, Fireworks), Program, Scene (HDR, Magic Frame, Beauty Shot, Night, Landscape, Text, Sunset, Dawn, Backlight, Beach & Snow, Zooming Shot), 3D Photo, DUAL IS, Panorama (Live Panorama, Action Panorama, 3D Panorama) • Burst: Single, High-speed (10fps, 5fps, 3fps), Precapture, AEB • Timer: 10 Sec, 2 Sec
Videos	<ul style="list-style-type: none"> • Modes: Smart Scene Detection (Landscape, Blue Sky, Natural Green, Sunset), Movie • Format: MP4 (H.264) (Max recording time: 20 min) • Size: 1920X1080, 1280X720, 640X480 • Frame Rate: 30fps, 15fps (only in some Smart Filter options) • High-speed: 440fps (240X176), 250fps (400X304) • Sound Alive: Sound Alive On, Sound Alive Off, Mute • Video editing (embedded): Pause during recording, Still image capture

Playback	
Photos	<ul style="list-style-type: none"> Type: Single image, Thumbnails, Multi Slide Show with Music and Effect, Movie clip, Smart Album* * Smart Album category: Type, Date, Week, Face Edit: Resize, Rotate, Image Adjust, Smart Filter, Trim Effect: Image Adjust (Red-eye Fix, Face Retouch, Brightness, Contrast, Saturation, Add Noise), Smart Filter (Normal, Miniature, Vignetting, Soft Focus, Old Film, Half Tone Dot, Sketch, Fish-eye, Classic, Retro, Oil Painting, Cartoon, Ink Painting, Cross Filter, Zooming Shot)
Videos	Edit: Creative Movie Maker, Still image capture, Time trimming
Storage	
Media	<ul style="list-style-type: none"> Internal memory: Approximately 16 MB External memory (Optional): microSD card (1-2 GB guaranteed), microSDHC card (up to 32 GB guaranteed) <p>Internal memory capacity may not match these specifications.</p>
File format	<ul style="list-style-type: none"> Still Image: JPEG (DCF), EXIF 2.21, DPOF 1.1, PictBridge 1.0 Movie Clip: MP4 (Video: MPEG-4.AVC/H.264, Audio: AAC)

		For 1 GB microSD: Number of photos			
			Super Fine	Fine	Normal
Image size	 4320X3240	133	165	215	
	 4320X2880	149	184	240	
	 3648X2736	183	225	292	
	 4320X2432	182	224	291	
	 2592X1944	341	413	523	
	 1984X1488	533	634	783	
	 1920X1080	699	820	991	
	 1024X768	1285	1432	1617	

These figures are measured under Samsung's standard conditions. Your results may vary depending on the shooting conditions and camera settings.

Camera specifications

Interface

Digital output connector	USB 2.0
Audio input/output	Internal speaker (Mono), Microphone (Stereo)
Video output	<ul style="list-style-type: none">• A/V: NTSC, PAL (selectable)• HDMI 1.4: NTSC, PAL (selectable)
DC power input connector	4.2 V

Power source

Rechargeable battery	Lithium-ion battery (BP70A, 740 mAh: Min. 700 mAh)
Connector type	Micro USB (5 pin)

The power source may differ depending on your region.

Dimensions (W X H X D)

90 X 55 X 18.7 mm (without protrusions)

Weight

110 g (without battery and memory card)

Operating Temperature

0-40 °C (32-104 °F)

Operating Humidity

5-85 %

Software

Intelli-studio

Specifications may change without notice to improve performance.

Glossary

AEB (Auto Exposure Bracket)

This feature automatically captures several images at different exposures to help you capture a properly-exposed image.

AF (Auto Focus)

A system that automatically focuses the camera lens on the subject. Your camera uses the contrast to focus automatically.

Aperture

The aperture controls the amount of light that reaches the camera's sensor.

Camera shake (Blur)

If the camera is moved while the shutter is open, the entire image may appear blurred. This occurs more often when the shutter speed is slow. Prevent camera shake by raising the sensitivity, using the flash, or using a faster shutter speed. Alternately, use a tripod, the DIS or OIS function to stabilize the camera.

Composition

Composition in photography means arranging objects in a photo. Usually, abiding by the rule of thirds leads to a good composition.

DCF (Design rule for Camera File system)

A specification to define a file format and file system for digital cameras created by the Japan Electronics and Information Technology Industries Association (JEITA).

Depth of field

The distance between the nearest and farthest points that can be acceptably focused in a photograph. Depth of field varies with lens aperture, focal length, and distance from the camera to the subject. Selecting a smaller aperture, for example, will increase the depth of field and blur the background of a composition.

Digital zoom

A feature that artificially increases the amount of zoom available with a zoom lens (Optical zoom). When using the Digital zoom, the image quality will deteriorate as the magnification increases.

DPOF (Digital Print Order Format)

A format for writing printing information, such as selected images and number of prints, on a memory card. DPOF-compatible printers, sometimes available at photo shops, can read the information from the card for convenient printing.

EV (Exposure Value)

All the combinations of the camera's shutter speed and lens aperture that result in the same exposure.

EV Compensation

This feature allows you to quickly adjust the exposure value measured by the camera, in limited increments, to improve the exposure of your photos. Set the EV compensation to -1.0 EV to adjust the value one step darker and 1.0 EV to one step brighter.

Exif (Exchangeable Image File Format)

A specification to define an image file format for digital cameras created by the Japan Electronic Industries Development Association (JEIDA).

Exposure

The amount of light allowed to reach the camera's sensor. Exposure is controlled by a combination of the shutter speed, the aperture value, and ISO sensitivity.

Flash

A speed light that helps to create adequate exposure in low-light conditions.

Focal length

The distance from the middle of the lens to its focal point (in millimeters). Longer focal lengths result in narrower angles of view and the subject is magnified. Shorter focal lengths result in wider angles of view.

Histogram

A graphical representation of the brightness of an image. The horizontal axis represents the brightness and the vertical axis represents the number of pixels. High points at the left (too dark) and right (too bright) on the histogram indicate a photo that is improperly exposed.

H.264/MPEG-4

A high-compression video format established by international standard organizations ISO-IEC and ITU-T. This codec is capable of providing good video quality at low bit rates developed by the Joint Video Team (JVT).

Image sensor

The physical part of a digital camera that contains a photosite for each pixel in the image. Each photosite records the brightness of the light that strikes it during an exposure. Common sensor types are CCD (Charge-coupled Device) and CMOS (Complementary Metal Oxide Semiconductor).

ISO sensitivity

The sensitivity of the camera to light, based on the equivalent film speed used in a film camera. At higher ISO sensitivity settings, the camera uses a higher shutter speed, which can reduce blur caused by camera shake and low light. However, images with high sensitivity are more susceptible to noise.

JPEG (Joint Photographic Experts Group)

A lossy method of compression for digital images. JPEG images are compressed to reduce their overall file size with minimal deterioration of the image resolution.

LCD (Liquid Crystal Display)

A visual display commonly used in consumer electronics. This display needs a separate backlight, such as CCFL or LED, to reproduce colors.

Macro

This feature allows you to capture close-up photos of very small objects. When using the macro feature, the camera can maintain a sharp focus on small objects at a near life-size ratio (1:1).

Metering

The metering refers to the way in which the camera measures the quantity of light to set the exposure.

MJPEG (Motion JPEG)

A video format which is compressed as a JPEG image.

MPO (Multi Picture Object)

An image file format that contains multiple images in a file. An MPO file provides a 3D effect on MPO-compatible displays, such as 3D TVs or 3D monitors.

Noise

Misinterpreted pixels in a digital image that may appear as misplaced or random, bright pixels. Noise usually occurs when photos are shot with a high sensitivity or when a sensitivity is automatically set in a dark place.

Optical zoom

This is a general zoom which can enlarge images with a lens and does not deteriorate quality of images.

Quality

An expression of the rate of compression used in a digital image. Higher quality images have a lower rate of compression, which usually results in a larger file size.

Resolution

The number of pixels present in a digital image. High resolution images contain more pixels and typically show more detail than low resolution images.

Shutter speed

Shutter speed refers to the amount of time it takes to open and close the shutter, and it is an important factor in the brightness of a photo, as it controls the amount of light which passes through the aperture before it reaches the image sensor. A fast shutter speed allows less time to let light in and the photo becomes darker and more easily freezes subjects in motion.

Smart zoom

Smart zoom lets you zoom in with less degradation of picture quality than the optical zoom and digital zoom.

Vignetting

A reduction of an image's brightness or saturation at the periphery (outer edges) compared to the center of the image. Vignetting can draw interest to subjects positioned in the center of an image.

White balance (color balance)

An adjustment of the intensities of colors (typically the primary colors red, green, and blue), in an image. The goal of adjusting the white balance, or color balance, is to correctly render the colors in an image.



**Correct Disposal of This Product
(Waste Electrical & Electronic Equipment)**

(Applicable in the European Union and other European countries with separate collection systems)

This marking on the product, accessories or literature indicates that the product and its electronic accessories (e.g. charger, headset, USB cable) should not be disposed of with other household waste at the end of their working life. To prevent possible harm to the environment or human health from uncontrolled waste disposal, please separate these items from other types of waste and recycle them responsibly to promote the sustainable reuse of material resources. Household users should contact either the retailer where they purchased this product, or their local government office, for details of where and how they can take these items for environmentally safe recycling. Business users should contact their supplier and check the terms and conditions of the purchase contract. This product and its electronic accessories should not be mixed with other commercial wastes for disposal.



PlanetFirst represents Samsung Electronics' commitment to sustainable development and social responsibility through eco-driven business and management activities.



Correct disposal of batteries in this product

(Applicable in the European Union and other European countries with separate battery return systems)

This marking on the battery, manual or packaging indicates that the batteries in this product should not be disposed of with other household waste at the end of their working life. Where marked, the chemical symbols Hg, Cd or Pb indicate that the battery contains mercury, cadmium or lead above the reference levels in EC Directive 2006/66. If batteries are not properly disposed of, these substances can cause harm to human health or the environment.

To protect natural resources and to promote material reuse, please separate batteries from other types of waste and recycle them through your local, free battery return system.

This Class [B] digital apparatus complies with Canadian ICES-003.

Dispose unwanted electronics through an approved recycler.
To find the nearest recycling location, go to our website:
www.samsung.com/recyclingdirect Or call, (877) 278 - 0799

FCC notice

- **NOTE:**

This equipment has been tested and found to comply with the limits for a Class B digital device, pursuant to part 15 of the FCC Rules. These limits are designed to provide reasonable protection against harmful interference in a residential installation. This equipment generates, uses and can radiate radio frequency energy and, if not installed and used in accordance with the instructions, may cause harmful interference to radio communications. However, there is no guarantee that interference will not occur in a particular installation. If this equipment does cause harmful interference to radio or television reception, which can be determined by turning the equipment off and on, the user is encouraged to try to correct the interference by one or more of the following measures:

- Reorientate, or relocate, the receiving antenna.
- Increase the distance between the equipment and receiver.
- Connect the equipment into an outlet on a circuit different from that to which the receiver is connected.
- Consult the dealer or an experienced radio / TV technician for help.

- **CAUTION:**

Changes or modifications not expressly approved by the manufacturer responsible for compliance could void the user's authority to operate the equipment.

- **Declaration of Conformity**

Trade Name	: Samsung Electronics America, Inc.
Model No.	: Samsung ST96
Responsible Party	: Samsung Electronics America, Inc.
Address	: 85 Challenger Road, Ridgefield Park, NJ 07660
Telephone No.	: 1-800-SAMSUNG (726-7864)

This device complies with Part 15 of the FCC Rules. Operation is subject to the following two conditions:
(1) This device may not cause harmful interference, and (2) this device must accept any interference received, including interference that may cause undesired operation.

Index

A

AF-assist light

- Location 14
- Settings 108

AF Lamp 108

AF Sound 106

Anynet+ 108

A/V port 14

B

Battery

- Caution 118
- Charging 18
- Inserting 17

Beauty Shot mode 39

Blink Detection 63

Brightness

- Playback mode 92
- Shooting mode 66

Burst modes

- AEB 71
- High-speed 70
- Precapture 71

C

Camera maintenance 112

Camera specifications 124

Capturing an image from video 86

Charging 18

Cleaning

- Camera body 112
- Display 112
- Lens 112

Connecting to a computer

- Mac 102
- Windows 97

Contrast

- Playback mode 92
- Shooting mode 74

D

Date/Time Set 107

Deleting files 81

Digital Print Order Format (DOF) 92

Digital zoom 28

Disconnecting the camera 101

Display brightness 106

Display type 25

DUAL IS mode 43

E

Editing photos 89

Editing videos

- Capturing 86
- Trimming 85

Enlarging 82

Error messages 111

Exposure 66

F

Face Detection 61

Flash

- Auto 56
- Fill in 56
- Intensity 56
- Off 55
- Red-eye 56
- Red-eye Fix 56
- Slow Sync 56

Focus area

- Center AF 60
- Multi AF 60
- Tracking AF 60

Formatting 108

Function button 16

G

Grid Line 106

H

Half-press shutter 31

HDMI Size 109

HDR mode 37

HDTV 95

I**Icons**

- Playback mode 76
- Shooting mode 21

Image Adjustment

- Add Noise 92
- Brightness
 - Playback mode 92
 - Shooting mode 66
- Contrast
 - Playback mode 92
 - Shooting mode 74
- Red-eye 91
- Saturation
 - Playback mode 92
 - Shooting mode 74
- Sharpness 74

Image quality 53

Imprint 108

Intelli-studio 99

ISO sensitivity 57

L

Language settings 107

M**Macro**

- Auto Macro 59
- Macro 59

Magic Frame mode 38

Memory card

- Caution 116
- Insert 17

Menu button 16

Metering

- Center-weighted 67
- Multi 67
- Spot 67

Movie mode 47

My star

- Cancelling 78
- Ranking 77
- Registering 64

O

Optical Image Stabilization (OIS) 30

Optional accessories 13

P**Panorama**

- 3D Panorama 44
- Action Panorama 46
- Live Panorama 44

PictBridge 103

Playback button 16

Playback mode 76

Power button 14

Power save mode 106

Printing photos 103

Program mode 41

Protecting files 80

Q

Quick view 106

R

Red-eye

Playback mode 91

Shooting mode 55

Reset 108

Resolution

Playback mode 89

Shooting mode 52

Retouching faces

Playback mode 91

Shooting mode 39

Rotating 89

S

Saturation

Playback mode 92

Shooting mode 74

Scene mode 36

Self portrait 62

Service center 121

Settings 107

Sharpness 74

Shooting portraits

Beauty Shot mode 39

Blink Detection 63

Face Detection 61

Red-eye 56

Red-eye fix 56

Self portrait 62

Smart Face Recognition 63

Smile Shot 62

Shutter button 14

Slide show 84

Smart Album 79

Smart Auto mode 34

Smart Face Recognition 63

Smart Filter

Playback mode 90

Shooting mode 72

Smart Scene Detection
mode 50

Smart zoom 29

Smile Shot 62

Sound settings 26

Status lamp 15

T

Thumbnails 80

Timer

Shooting mode 54

Timer lamp 14

Time settings 19

Time zone settings 19, 107

Transferring files

Mac 102

Windows 97

Tripod mount 14

U

Unpacking 13

USB port 14

V

Video

Playback mode 85

Shooting mode 47

Video out 109

Viewing files

Folder 78

Slide show 84

Smart Album 79

Thumbnails 80

TV 94

W

White Balance 68

Z

Zoom

Using the zoom 28

Zoom button 15

Zoom sound settings 47

Zooming Shot mode 40

3

3D Photo mode 42

3D TV 96



Please refer to the warranty that came with your product or visit our website www.samsung.com for after-sales service or inquiries.

