



Sony Ericsson
Yendo™ with Walkman™
Extended User guide

Contents

Experience more. Discover how.....	5
Getting started.....	6
Starting your phone for the first time.....	7
Getting to know your phone.....	9
Phone overview.....	9
Charging the battery.....	9
Using the home key.....	10
Home screen.....	10
Applications panes.....	11
Using the touch screen.....	12
Internet and messaging settings.....	12
Phone settings overview.....	12
Entering text.....	12
Contacts	14
Calling.....	15
Music.....	16
Walkman™ player overview.....	16
Walkman™ player widget.....	17
Walkman™ mini-player.....	17
Connecting your phone to a computer.....	18
Transferring and handling content using a USB cable.....	18
Camera.....	19
Viewfinder and camera controls.....	19
TrackID™ technology.....	20
PlayNow™.....	21
Multimedia and text messaging.....	22
Email.....	23
Bluetooth™ wireless technology.....	24
Phone name.....	24
Web browser.....	25
Browsing the web.....	25
More features.....	26
Alarms.....	26
Calendar.....	26
Voicemail.....	26
Locking and protecting your phone.....	28
IMEI number.....	28

Troubleshooting	29
Common questions.....	29
Error messages.....	29
Legal information	31
Index	32

Important information

Please read the *Important information* leaflet before you use your mobile phone.

- ! Some of the services and features described in this User guide are not supported in all countries/regions or by all networks and/or service providers in all areas. Without limitation, this applies to the GSM International Emergency Number 112. Please contact your network operator or service provider to determine availability of any specific service or feature and whether additional access or usage fees apply.

Experience more. Discover how.

Visit www.sonyericsson.com/support to get the most from your phone.

Getting started

To insert the SIM card



- 1 Remove the battery cover.
- 2 Slide the SIM card into its holder with the gold-coloured contacts facing down.

To insert or remove a memory card

- ! You may have to purchase a memory card separately.

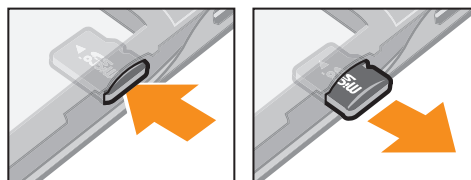

- 1 Insert the memory card with the gold-coloured contacts facing down.
- 2 To remove the memory card, press the edge of the memory card inwards and release it immediately.

To insert the battery



- 1 Insert the battery with connectors facing each other.
- 2 Attach the battery cover.

To turn on the phone

- 1 Press and hold down the **⏻** key on the top of your phone.
- 2 Enter your SIM card PIN, if requested, and select **Done**.
- 3 At first startup, follow the setup instructions that appear.

- 💡 Your PIN is supplied by your network operator. If you want to correct a mistake made while entering your SIM card PIN, press **✖**.

To turn off the phone

- Press and hold the **⏻** key on the top of the phone until the phone turns off.

To lock the screen

- When the screen is active, briefly press the **⏻** key.

To unlock the screen

- When the screen is locked, briefly press the **⏻** key.

Starting your phone for the first time

The first time you start your phone, a setup wizard helps you enter essential phone settings. Follow the steps to select your language, import your SIM contacts, and set the time and date, respectively. If you prefer, you can skip some steps and access the setup wizard later from the phone settings menu.

To set the phone language

- 1 When you start your phone for the first time, a list of languages appears. Scroll through the list and select your language.
- 2 Tap **Done**.

To import contacts from a SIM card

- When you start your phone for the first time with a SIM card inserted, the setup wizard prompts you to import your SIM contacts. Tap **Import contacts**.
- 💡 When you copy contacts between two phones using your SIM card, the amount and the type of information you can transfer for each contact is limited. To get more help on how to copy contacts between two phones, go to www.sonyericsson.com/support.

To set the time and date

- 1 When you start your phone for the first time, the setup wizard prompts you to set the time and date. Tap **Time & date**.
 - 2 Find and tap **Time**.
 - 3 Tap the hour and minute fields to adjust the time.
 - 4 Tap **Save**.
 - 5 Find and tap **Date**.
 - 6 Tap the day, month and year fields to adjust the date.
 - 7 Tap **Save**.
-  While setting the time and date, you can also select your preferred time and date display formats. Tap **Time format** or **Date format** to select a desired format.

Getting to know your phone

Phone overview

- 1 3.5 mm Audio Video Plus connector
- 2 Power key/screen lock
- 3 Ear speaker
- 4 Strap hole
- 5 Connector for charger/USB cable
- 6 Touch screen
- 7 Home key
- 8 Microphone

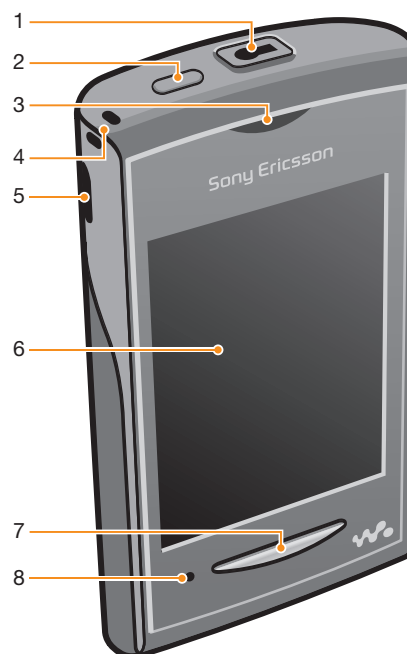

- 9 Volume key
- 10 Camera lens
- 11 Speaker

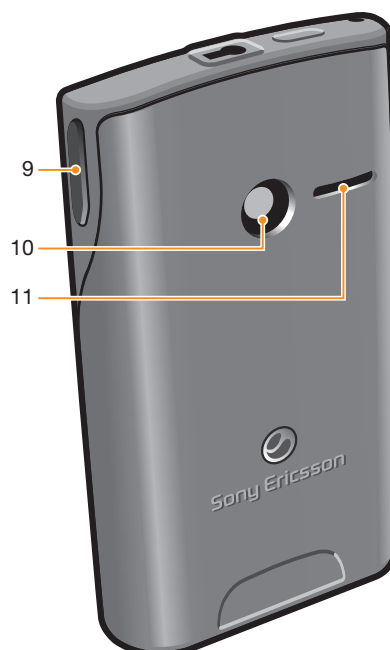

Charging the battery

Your phone battery is partly charged when you buy the phone. It may take a few minutes before the battery icon  appears on the screen when you connect the phone charger cable to a power source, such as a USB port or a phone charger. You can still use your phone while it is charging.

- ! The battery will start to discharge a little after it is fully charged and then charges again after a certain time. This is to extend battery life and may result in the charge status showing a level below 100 percent.

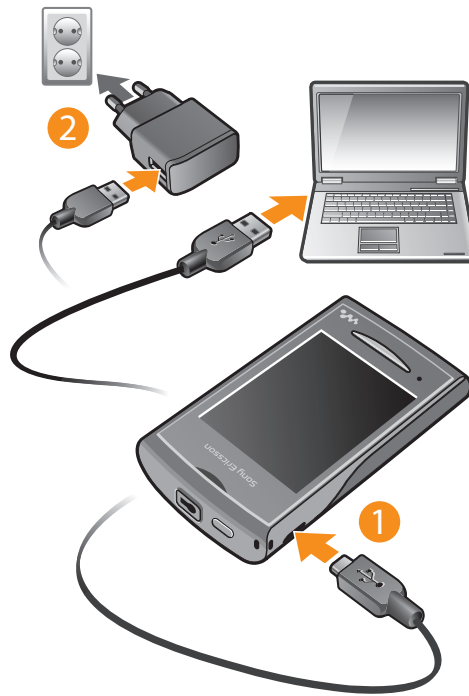

To charge the phone using the power adapter

- Connect the phone to a power outlet using the USB cable and the power adapter.

Using the home key



To go to the home screen

- Press the home key.

Home screen

The **Home screen** is your gateway to the main features in your phone. You can customise it with different application icons, shortcuts, wallpaper and more. The **Home screen** extends beyond the regular screen display width, giving you more room to play with.

- ! Close your opened applications before going to the **Home screen**. Otherwise, these applications may stay running in the background and slow down your phone.

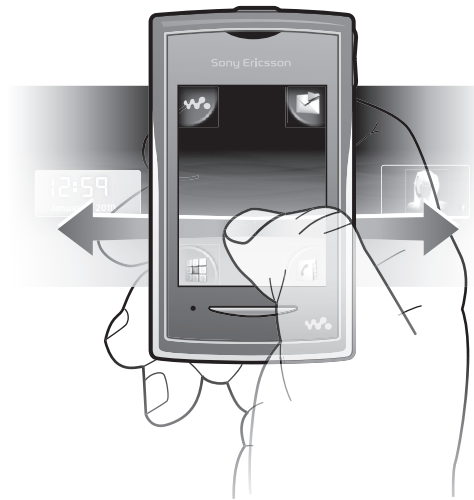

Applications panes

Use the applications panes to get quick access to applications in your phone. You can also customise your panes. Remember that applications panes extend beyond the regular screen dimensions, so you might have to flick left or right to see everything.



- 💡 An indicator at the top of the screen shows which of the applications panes you are in. For example, ● ○ ● indicates you are in the middle applications pane.

To open the applications panes

There are two ways to open the applications panes:

- From the **Home screen**, drag  upwards.
- Flick upwards from any location on the **Home screen**.

To browse the applications panes

- From the applications panes, flick right or left.

To move an application

- 1 From the **Home screen**, drag  upwards.
- 2 Touch and hold an item until application icons appear in four corners of the screen.
- 3 Drag the item into one of the corners, or into another applications pane.

- 💡 The items in the applications panes are the actual applications, and are not shortcuts. So if you move an item from one applications pane to another location, you are moving the actual application, and not creating a shortcut.

Using the touch screen

To open or highlight an item

- Tap the item.

To mark or unmark options

- Tap the relevant checkbox, or in some cases tap the switch beside the option name.



To go back to the previous screen

- Tap , when this option is available.

Scrolling

Scroll by moving your finger up or down on the screen. On some web pages you can also scroll to the sides.

- ! Dragging or flicking will not activate anything on the screen.

Internet and messaging settings

For most mobile phone networks and operators, messaging and Internet settings come preinstalled on your phone. In some cases the settings are downloaded the first time you turn on the phone with your SIM card inserted.

You can manually add and change Internet and network settings in your phone at any time, or you can get the settings sent to your phone automatically. Contact your network operator if you need more information about your subscription settings.

Phone settings overview

You can customise some phone settings to suit your preferences. For example, you can adjust the **Time & date** and **Phone language** settings.

To change the phone language

- 1 From the **Home screen**, drag  upwards.
- 2 Find and tap **Settings** > **Language and writing** > **Phone language**.
- 3 Select an option.

- ! If you choose the wrong language and cannot read the menu texts, go to www.sonyericsson.com/support for help.

To turn on Flight mode

- 1 From the **Home screen**, drag  upwards.
- 2 Find and tap **Settings** > **General**.
- 3 Select **Flight mode**.

Entering text

There are two text input methods: multitap and quick text . Quick text input uses the in-phone dictionary to help you spell words.

To display the keypad and enter text

- Tap a text field to display the keypad, then enter your text.

To shift between upper-case and lower-case letters

- Before you enter a letter, tap .

To turn on the caps lock

- Before you type a word, tap  until  appears.

To enter numbers using the keypad

- When you enter text, tap . A keypad with numbers appears.

To insert symbols

- When you enter text, tap . A keypad with symbols appears.



To change the writing language

- 1 When you enter text, tap the language icon, for example, .
- 2 Select an option.

To enter text using multitap text input

- 1 When you enter text, tap the language icon, for example, .
- 2 Tap **Multitap** to change to multitap input.
- 3 To write a word, tap the character key as many times as needed to show the letter you want.

To enter text using quick text input

- 1 When you enter text, tap the language icon, for example, .
- 2 Tap **Quick text** to change to quick text input.
- 3 To write a word, tap each character key only once, even if the letter you want is not the first letter on the key.
- 4 Tap the word that appears or tap  to select a word from the list.
- 5 If the word you want is not in the list, tap **Spell**, make any necessary changes, and tap **Save**.

Contacts

Use the **Contacts** application to save information about the people you know. Enter their phone numbers, email addresses, birthdays and other details. You can keep track of all communication with a particular contact.

To call a contact

- 1 From the **Home screen**, tap .
- 2 Tap the contact.
- 3 Tap the desired phone number for the contact.

To add a contact

- 1 From the **Home screen**, tap .
- 2 Tap **Add contact**.
- 3 Tap **Name**, enter the name and tap **Done**.
- 4 Tap **Phone number**, enter the phone number and tap **Done**.
- 5 Enter or select the desired additional information for the contact, then scroll up and tap **Save**. To add additional information fields, tap **Add more**.

 You can also add contacts from numbers in your call log.

To back up contacts on a memory card



- 1 From the **Home screen**, drag  upwards.
- 2 Tap **Settings** > **Contacts** > **Back up to memory card**.

To restore contacts from a memory card

- 1 From the **Home screen**, drag  upwards.
- 2 Tap **Settings** > **Contacts** > **Restore from memory card**.





Calling

To make an emergency call

- 1 From the **Home screen**, tap .
- 2 Enter the emergency number and tap . To delete a number, tap .



 You can make emergency calls when no SIM card is inserted.

To make a call

- 1 From the **Home screen**, tap .
- 2 If the call log appears, tap  to enter the dial pad view.
- 3 Enter the number you want to call and tap . To delete a number, tap .

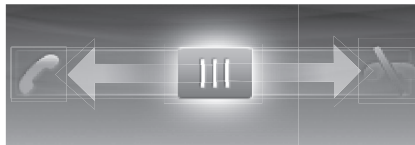
To answer a call



- Drag  to the left until it touches .

To decline a call

- Drag  to the right until it touches .

To end a call

- Tap .

Music

Get the most out of your Walkman™ player. Listen to music, audio books and podcasts. Manage your own playlists, and send your favourite tunes to friends.





- 💡 Install the Media Go™ application on your computer and transfer content to and from the memory card in your phone. Media Go™ can be downloaded from www.sonyericsson.com/support.

Walkman™ player overview



- 1 Browse the music on your memory card
- 2 Cover art (if available)
- 3 Go to the previous track in the current play queue, or rewind
- 4 Play/pause button
- 5 Progress indicator: fast forward or rewind by dragging or tapping
- 6 Current track time remaining
- 7 Go to the next track in the current play queue, or fast forward
- 8 View the current play queue

To play audio content

- 1 From the **Home screen**, tap .
- 2 Tap .
- 3 Tap  to browse audio by artist. Tap  to browse audio by playlist. Tap  to browse audio by track.
- 4 Scroll up or down and browse to a track.
- 5 Tap a track to play it.

To pause a track

- In the Walkman™ player, tap .

To fast forward and rewind music



- In the Walkman™ player, touch and hold  or .

- 💡 You can also drag the progress indicator marker right or left.

To send or delete a track

- 1 In the Walkman™ player, tap the cover art for a particular track.
- 2 Selete an option.

To play smart playlists

- 1 In the Walkman™ player, tap .
- 2 Tap .
- 3 Under **Smart playlists**, tap a playlist.
- 4 Tap a track to play it.

To adjust the audio volume

- Press the volume key.



Walkman™ player widget

The Walkman™ player widget appears on your **Home screen** when you minimise the Walkman™ player, but you might have to flick left or right to find it.

Walkman™ mini-player

Use the Walkman™ mini-player to control music playback features when the screen is locked.

To use the mini-player when the screen is locked

- 1 Press the volume key to activate the mini-player.
- 2 Tap ,  or  to control the playback.

Connecting your phone to a computer

Connect your phone to a computer and start transferring pictures, music and other file types.

- ! You might not be able to transfer some copyright-protected material between your phone and computer.

Transferring and handling content using a USB cable

The most common way to transfer files between your phone and a computer is using a USB cable. Once the phone and computer are connected, you can drag and drop content from one to the other using your computer's file explorer.

- ! Make sure you place files in the corresponding folder types. For example, put your music files in the *Music* folder. Java application files are an exception. You should place them in the *Other* folder.

To drag and drop content between your phone and a computer

- 1 Connect the USB cable to the phone and the computer.
- 2 **Phone:** Select **Mass storage**.
- 3 **Computer:** Wait until the phone memory and memory card appear as external disks in the file explorer.
- 4 **Computer:** On the computer desktop, double-click the *My Computer* icon.
- 5 **Computer:** To view the phone memory and memory card folders, double-click the icon representing your phone.
- 6 **Computer:** Copy and paste your file, or drag and drop it, into a corresponding folder on your computer, in your phone memory, or on your memory card.

- ! You cannot use your phone while transferring files.

To disconnect the USB cable safely

- ! Do not disconnect the USB cable while you are transferring content as this may corrupt the content.
- 1 **Computer:** Use the Safely Remove Hardware function to select the device you want to unplug, then click *Stop*.
 - 2 Disconnect the USB cable.
- ! Computer instructions may vary depending on your operating system. See the documentation of your computer's operating system for more information.



Camera

Take photos, record videos, view albums and share your favourite clips and pictures with friends – all with your camera application.

To activate the camera

- 1 From the **Home screen**, drag  upwards.
- 2 Find and tap **Camera**.

To take a photo

- 1 Activate the camera.
- 2 If the still camera is not selected, tap .
- 3 Point the camera towards the subject and tap . A photo is taken and appears in review mode.
- 4 To return to the camera viewfinder, tap .

Viewfinder and camera controls

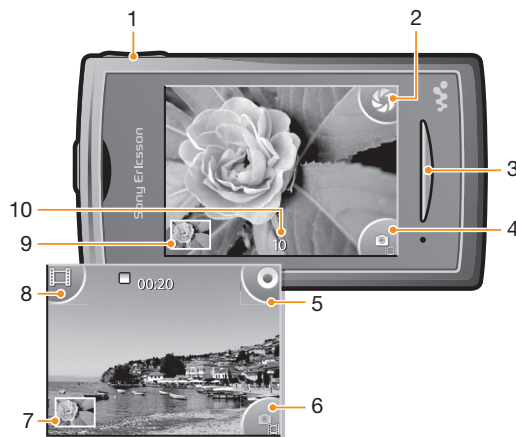



- 1 Zoom in and out (only available in video mode)
- 2 Take photos
- 3 Exit the camera
- 4 Switch between still and video camera
- 5 Record video clips
- 6 Switch between still and video camera
- 7 View photos and video clips
- 8 Select video length
- 9 View photos and video clips
- 10 Number of remaining photos you can take

TrackID™ technology

Use the TrackID™ music recognition service to identify a music track you hear playing in your surroundings. Just record a short sample of the song and you'll get artist, title and album info within seconds. You can also purchase tracks identified by TrackID™. For best results, use TrackID™ technology in a quiet area. If you have problems using this application, see *I cannot use Internet-based services* on page 29.

- ! The TrackID™ application and the TrackID™ service are not supported in all countries/ regions, or by all networks and/or service providers in all areas.

To open the TrackID™ application

- 1 From the **Home screen**, drag  upwards.
- 2 Find and tap **TrackID™** .

To search for track information



- 1 Open the **TrackID™** application and tap **Record**.
- 2 Hold your phone towards the music source. The results are shown in the result screen.
- 3 Flick left or right to view previous search results.

PlayNow™

Use the PlayNow™ application in your phone to browse, purchase and download the latest music, games, ringtones, applications, themes and wallpapers.



! PlayNow™ is not available in all countries.

To start PlayNow™

- 1 From the **Home screen**, drag  upwards.
- 2 Find and tap .

Multimedia and text messaging

To create and send a message

- 1 From the **Home screen**, tap .
- 2 Tap **New message > Write message**. Enter your message text and tap .
- 3 To add a recipient, select a contact from the list that appears. You can also tap the text field, enter a number manually, and then tap **Done**.
- 4 If you want to add a photo or a video, tap  and select an option.
- 5 When you are finished, tap **Send**.



To read a received message

- 1 From the **Home screen**, tap .
- 2 Tap a message thread.
- 3 To download a message that is not downloaded yet, tap the message.
- 4 If the received message contains music or a video, tap the item and then tap **View video** or **Play audio**.



Email

Use your phone to send and receive emails through your regular email account. Before you get started, you need the correct Internet settings in your phone. See *Internet and messaging settings* on page 12.



To set up an email account in your phone

- 1 From the **Home screen**, drag  upwards.
 - 2 Find and tap **Email**.
 - 3 Select an email account. If the account you want to use is not in the list, tap **Other**.
 - 4 Enter your Email address and password, then tap **Continue**.
 - 5 If the phone cannot download your email account settings automatically, enter them manually.
-  If you need to enter the settings manually, contact your email service provider for the correct email account settings. For example, you need to know if the account type is POP3 or IMAP.

To create and send an email message

- 1 From the **Home screen**, drag  upwards.
- 2 Find and tap **Email**.
- 3 Tap **Write new**.
- 4 Tap **To:** and enter the recipient's address, then tap **Done**. You can add more recipients the same way, or delete a recipient by tapping .
- 5 Tap **Subject** and enter the email subject.
- 6 Tap **Write email**, then enter your message text.
- 7 To attach a file, tap **Attach**, select the type of file, and then select the file you want to send.
- 8 Tap **Send**.

To receive and open email messages

- 1 From the **Home screen**, drag  upwards.
- 2 Find and tap **Email**.
- 3 Tap **Inbox**.
- 4 To update the inbox with new messages, tap .
- 5 To open and read a message, tap the message.

Bluetooth™ wireless technology

Turn on the Bluetooth™ function in your phone and create wireless connections to other Bluetooth™ compatible devices such as computers, handsfree accessories, and phones. Bluetooth™ connections work better within a 10 metre (33 feet) range, with no solid objects in between. In some cases you have to manually pair your phone with other Bluetooth™ devices. Remember to set your phone to visible if you want other Bluetooth™ devices to detect it.

To turn on the Bluetooth™ function and make your phone visible

- 1 From the **Home screen**, drag  upwards.
- 2 Find and tap **Settings** > **Connectivity** > **Bluetooth**.
- 3 Tap **Bluetooth** and tap the on/off button to turn on Bluetooth.  appears in the status bar.
- 4 Tap **Visibility** and tap the on/off button to make your phone visible.

Phone name

You can give your phone a name. This name is shown to other devices after you have turned on the Bluetooth™ function and your phone is set to visible.

To give your phone a name

- 1 From the **Home screen**, drag  upwards.
- 2 Find and tap **Settings** > **Connectivity** > **Bluetooth** > **Device name**.
- 3 Enter your desired phone name.
- 4 Tap **OK**.

To pair your phone with another Bluetooth™ device



- 1 From the **Home screen**, drag  upwards.
 - 2 Find and tap **Settings** > **Connectivity** > **Bluetooth**.
 - 3 Tap **Add new device**. The Bluetooth™ devices found will be shown in a list.
 - 4 Tap the Bluetooth™ device that you want to pair with your phone.
 - 5 Enter a passcode, if required.
 - 6 The phone and the Bluetooth™ device are now paired. In some cases, you may need create connection manually after pairing. The status of the pairing and connection is shown below the name of the Bluetooth™ device in the **My devices** list.
- ! Make sure the device you want to pair your phone with has the Bluetooth™ function activated and has Bluetooth™ visibility turned on.

Web browser

Browsing the web

View and navigate web pages, bookmark your favourites, create shortcuts, and browse with several windows open at the same time – all with your web browser.

To open the web browser

- 1 From the **Home screen**, drag  upwards.
- 2 Find and tap **Browser** .

To go to a web page

- 1 Tap .
- 2 Tap the text field to activate the keypad.
- 3 Enter a web address.
- 4 Tap **Go to**.

More features

Alarms

Customise your alarm and wake up to your preferred alarm tone or radio station. Activated alarms sound even if your phone is turned off.

To set a new alarm

- 1 From the **Home screen**, drag  upwards.
- 2 Find and tap **Alarm**.
- 3 Tap **Add new**.
- 4 Set an alarm time and enter the relevant details in the **Alarm text**, **Recurrence** and **Alarm signal** fields, then tap **Done**.

To delete an alarm

- 1 From the **Home screen**, drag  upwards.
- 2 Find and tap **Alarm**.
- 3 Scroll to the alarm you have set and want to delete, and tap it.
- 4 Scroll down and Tap **Delete**.



To silence the alarm

- 1 When the alarm sounds, drag **Slide to turn off** to the right to turn off the alarm.
- 2 To repeat the alarm, select **Snooze**.

Calendar

Use your phone calendar to manage your schedule and appointments.

To open the Calendar application

- 1 From the **Home screen**, drag  upwards.
 - 2 Find and tap **Calendar**.
-  When you open the **Calendar** application for the first time, it opens in month view. If you have previously used the application, it opens in the view you last used.

To log in to Facebook

- 1 From the **Home screen**, drag  upwards.
- 2 Find and tap **Facebook**.
- 3 Enter your login details.

To log in to Twitter

- 1 From the **Home screen**, drag  upwards.
- 2 Find and tap **Twitter**.
- 3 Enter your login details.

Voicemail

If your subscription includes a voicemail service, callers can leave voice messages for you when you can't answer calls. Your voicemail service number is normally saved on your SIM card. If not, you can get the number from your service provider and enter it manually.

To enter your voicemail service number

- 1 From the **Home screen**, drag  upwards.
- 2 Select **Settings > Calls > Voicemail**.
- 3 Enter your voicemail number and tap **Done**.

To call your voicemail service

- 1 From the **Home screen**, drag  upwards.
- 2 Tap **Voicemail**.

Locking and protecting your phone

IMEI number

Every phone has a unique IMEI (International Mobile Equipment Identity) number. You should keep a copy of this number. If your phone is stolen, your network provider can use your IMEI number to stop the phone from accessing the network in your country.

To view the IMEI number in your phone

- 1 From the **Home screen**, drag  upwards.
- 2 Find and tap **Settings** > **General** > **About phone**.

To change your SIM card PIN

- 1 From the **Home screen**, drag  upwards.
- 2 Find and tap **Settings** > **General** > **Security** > **Change PIN**, then follow the instructions.

Troubleshooting

Common questions

My phone is not working as expected

If you experience problems with your phone, check these tips before you try anything else:

- Restart your phone.
- Remove and re-insert the battery and SIM card. Then restart your phone.
- Update your phone. Even if you have the latest software, updating your phone can improve software stability and solve other problems. By running the latest update on your phone, you also ensure optimal performance and get the latest enhancements.
- Reset your phone.

 Be patient while resetting your phone. Restarting the phone during a reset procedure may damage the phone permanently.

Resetting the phone

When you reset your phone, you delete all data, including downloaded applications. You are basically resetting the phone to the state it was in before you first turned it on. So before you perform a reset, make sure to back up any important data saved on your phone.

To reset the phone

- 1 From the **Home screen**, drag  upwards.
- 2 Find and tap **Settings** > **General** > **Master reset** > **Reset all** .
- 3 Tap **Reset**.

No battery charging icon appears when I start charging the phone

It may take a few minutes before the battery icon appears on the screen.

I cannot use Internet-based services

Make sure your subscription covers data downloads and that the Internet settings in your phone are correct. Contact your network operator for more information about your subscription settings.

Error messages

No network coverage

- Your phone is in flight mode. Make sure flight mode is off.
- Your phone is not receiving any network signal, or the received signal is too weak. Contact your network operator and make sure that the network has coverage where you are.
- The SIM card is not working properly. Insert your SIM card in another phone. If this works, it is probably your phone that is causing the problem. In this case, contact the nearest Sony Ericsson service center.

Emergency calls only

You are within range of a network, but you are not allowed to use it. However, in an emergency, some network operators allow you to call the international emergency number 112.

SIM locked

You have entered your PIN incorrectly three times in a row. To unlock the phone, you need the PUK ((Personal Unblocking Key) provided by your operator.

PUK blocked. Contact operator.

You have entered your PUK code incorrectly 10 times in a row. Please contact your service provider.

Legal information

Sony Ericsson Yendo™ with Walkman™ W150i

This User guide is published by Sony Ericsson Mobile Communications AB or its local affiliated company, without any warranty. Improvements and changes to this User guide necessitated by typographical errors, inaccuracies of current information, or improvements to programs and/or equipment, may be made by Sony Ericsson Mobile Communications AB at any time and without notice. Such changes will, however, be incorporated into new editions of this User guide. All rights reserved.

©Sony Ericsson Mobile Communications AB, 2010

Publication number: 1239-1711.1

Attention: Some of the services and features described in this User guide are not supported by all networks and/or service providers in all areas. Without limitation, this applies to the GSM International Emergency Number 112. Please contact your network operator or service provider to determine availability of any specific service or feature and whether additional access or usage fees apply.

Your mobile phone has the capability to download, store and forward additional content, e.g. ringtones. The use of such content may be restricted or prohibited by rights of third parties, including but not limited to restriction under applicable copyright laws. You, and not Sony Ericsson, are entirely responsible for additional content that you download to or forward from your mobile phone. Prior to your use of any additional content, please verify that your intended use is properly licensed or is otherwise authorized. Sony Ericsson does not guarantee the accuracy, integrity or quality of any additional content or any other third party content. Under no circumstances will Sony Ericsson be liable in any way for your improper use of additional content or other third party content.

The Liquid Identity logo and TrackID are trademarks or registered trademarks of Sony Ericsson Mobile Communications AB.

This User guide may reference services or applications provided by third parties. Use of such programming or services may require separate registration with the third party provider and may be subject to additional terms of use. For applications accessed on or through a third-party website, please review such websites' terms of use and applicable privacy policy in advance. Sony Ericsson does not warrant or guarantee the availability or performance of any third-party websites or offered services.

WALKMAN, WALKMAN logo, Sony, Memory Stick Micro™ and M2™ are trademarks or registered trademarks of Sony Corporation.

The Liquid Identity logo and Yendo are trademarks or registered trademarks of Sony Ericsson Mobile Communications AB.

Sony and "make.believe" are trademarks or registered trademarks of Sony Corporation.

Bluetooth is a trademark or a registered trademark of Bluetooth SIG Inc. and any use of such mark by Sony Ericsson is under license.

Media Go is a trademark or registered trademark of Sony Electronics Inc.

Ericsson is a trademark or registered trademark of Telefonaktiebolaget LM Ericsson.

Facebook and the F logo are trademarks or registered trademarks of Facebook, Inc.

Twitter and the Twitter T are trademarks or registered trademarks of Twitter, Inc.

TrackID™ is powered by Gracenote Mobile MusicID™. Gracenote and Gracenote Mobile MusicID are trademarks or registered trademarks of Gracenote, Inc.

The Liquid Identity logo, PlayNow, TrackID, are trademarks or registered trademarks of Sony Ericsson Mobile Communications AB.

WALKMAN, WALKMAN logo are trademarks or registered trademarks of Sony Corporation.

This product is protected by certain intellectual property rights of Microsoft. Use or distribution of such technology outside of this product is prohibited without a license from Microsoft.

Other product and company names mentioned herein may be the trademarks of their respective owners. Any rights not expressly granted herein are reserved. All other trademarks are property of their respective owners.

All illustrations are for illustration only and may not accurately depict the actual phone.

Microsoft, Windows and Vista are registered trademarks or trademarks of Microsoft Corporation in the United States and/or other countries.

"Export Regulations: This product, including any software or technical data contained in or accompanying the product, may be subject to import and export regulations of the European Union, the United States and other countries. The user and any possessor of the product agrees to comply strictly with all such regulations and acknowledges that it is their responsibility to obtain any required licenses to export, re-export, or import this product. Without limiting the foregoing, and as an example, the user and any possessor of the product: (1) must not knowingly export or re-export Products to destinations identified pursuant to Articles in Chapter II of European Council Regulation (EC) 428/2009; (2), must comply with U.S. government Export Administration Regulations ("EAR", 15 C.F.R. §§ 730-774, <http://www.bis.doc.gov/>) administered by Department of Commerce, Bureau of Industry and Security; and (3) must comply with economic sanctions regulations (30 C.F.R. §§ 500 et. seq., <http://www.treas.gov/offices/enforcement/ofac/>) administered by the U.S. Department of Treasury, Office of Foreign Assets Control. The user and any possessor of the product may not transport or deliver the product, its accessories or separate software to any country, region, entity or person prohibited by these regulations."

Index

A	
adjusting volume	17
answering service	26
applications	21
audio	
adjusting volume	17
playing	16
B	
battery	9
Bluetooth™ wireless technology	24
<i>browsing - see web browser</i>	
C	
calls	15
caps lock	12
charging	9
contacts	14
G	
games	21
H	
Home screen	10
I	
input method	12
Internet	
web browser	25
K	
keypad	12
M	
messages	
multimedia	22
picture	22
text	22
MMS	22
multimedia messages	22
music	16
adjusting volume	17
audiobooks	16
downloading	21
pausing a track	16
player overview	16
playing	16
podcast	16
music player	
smart playlists	17
N	
navigation	12
O	
overview	
Walkman™ player	16
P	
pausing a track	16
personal information	14
phonebook	14
picture messages	22
PIN	28
playing	
music	16
playlists	
smart (auto-generated)	17
PlayNow™	21
PUK	28
R	
reset	29
S	
screen lock	28
screen lock pattern	28
searching	
music using TrackID™ technology	20
track information	20
setup guide	7
SIM	28
SIM card	
inserting	6
smart playlists	
playing	17
SMS	22
symbols	12
T	
<i>telephony See calls</i>	
text messages	22
TrackID™ technology	20
opening	20
searching for track information	20
troubleshooting	29
U	
USB connection	18
V	
voicemail	26
W	
Walkman™ player	16
web browser	25