

**Canon**

**PowerShot S110**  
DIGITAL ELPH

DIGITAL  
IXUS 

# Camera User Guide



## Flowchart and Reference Guide

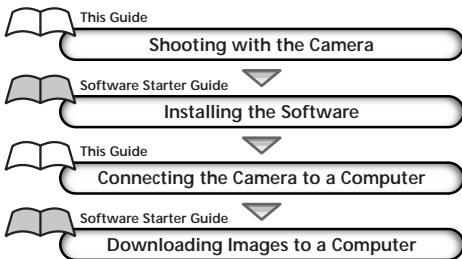

- Please start by reading the Precaution on the reverse side of this cover.
- Please see the user's guide for the printer for operating instructions for Card Photo Printer CP-10.

**ENGLISH**

## Precautions

### Camera Body Temperature

If your camera is used for prolonged periods, the camera body may become warm. Please be aware of this and take care when operating the camera for an extended period.

### About the LCD monitor

The LCD monitor is produced with extremely high-precision manufacturing techniques. With more than 99.99% of the pixels operating to specifications, less than 0.01% of the pixels may occasionally misfire or appear as black, red or green dots. This has no effect on the recorded image and does not constitute a malfunction.

**Notice:** Please ensure that you read and follow the handling and safety precautions on pages 5 to 9 of this guide before attempting to use the camera.

### Video Format

Please set the camera's video signal format to the one used in your region before using it with a TV monitor (p. 82).

### Language Setting

Please see page 83 to change the language setting.

### Charging the Date/Time Battery

- The camera has a built-in rechargeable lithium battery that maintains the date, time and other camera settings. This battery recharges when the main battery pack is inserted into the camera. When you first purchase the camera, place a charged battery pack in it or use the AC adapter kit (sold separately) for at least 4 hours to charge the date/time battery. It will charge even when the camera power is set to Off.
- If the Set Date/Time menu appears when the camera power is turned on, it means that the date/time battery charge is depleted. Recharge it as described above.

# Table of Contents

Read This First .....	5
Quick Start .....	10

## Preparing the Camera

Guide to Components .....	12
Front View .....	12
Back View .....	13
Operation Panel .....	14
Charging the Battery Pack .....	15
Installing the Battery Pack .....	17
Using a Household Power Source .....	19
Installing a CF Card .....	20
Setting the Date and Time .....	22
Attaching the Wrist Strap .....	23

## Basic Functions

Turning the Power On/Off .....	24
Switching between the Shooting/Replay Modes .....	25
Using the Viewfinder .....	26
Using the LCD Monitor .....	27
Shooting Mode .....	27
Replay Mode .....	28
Information Displayed on the LCD Monitor .....	28
Shooting Mode .....	28
Replay Mode (Standard Display) .....	29
Replay Mode (Detailed Display) .....	29
LCD Monitor Menus/Switching between Display Modes .....	30
Shooting .....	30
Replaying .....	30
Pressing the Shutter Button .....	32

Reviewing an Image Immediately after Recording It .....	33
Changing the Default Review Setting .....	34
Adjusting the Zoom (Angle of View) .....	35
Telephoto/Wide Angle .....	35
Digital Zoom .....	35

## Shooting

Selecting a Shooting Mode .....	36
Changing Resolution/Compression Settings .....	37
⚡ Using the Flash .....	39
Shooting 📷 Close-Ups/▲ Infinity Shots .....	41
📺 Shooting Continuously .....	42
🕒 Using the Self-Timer .....	43
Adjusting the Exposure Compensation .....	44
Setting the White Balance .....	45
Shooting in Stitch Assist Mode .....	46
Framing a Subject .....	46
Shooting .....	47
Shooting a Movie .....	49
Functions Available in Each Shooting Mode .....	51

## Replaying

Displaying Images Singly (Single Image Replay) .....	52
🔍 Zooming an Image .....	53
📺 Displaying Images in Sets of Nine (Index Replay) .....	54
Switching between Sets of Nine Images .....	55
Replaying a Movie .....	56
Rotating Images in the Display .....	57
Automating Playback (Auto Play) .....	58
Protecting Images .....	60

## Erasing Images

Erasing Images Singly .....	61
Erasing All Images .....	62

## Print Settings (DPOF Settings)

Displaying the Print Settings Menu .....	63
Setting the Print Style .....	64
Selecting Images for Printing .....	65
Resetting Print Settings .....	68

## Printing with Card Photo Printer CP-10

Connecting Card Photo Printer CP-10 .....	69
Printing .....	70
Printing the Displayed Image .....	70
Printing with DPOF Print Settings .....	72
Setting the Print Style .....	75

## Camera Settings

Displaying the Rec. Menu .....	77
Resetting the File Number .....	78
Setting the Beep On/Off .....	79
Formatting CF Cards .....	80
Changing Other Settings .....	81
Switching the Auto Power Down Function On/Off .....	81
Setting the Video Signal Format .....	82
Setting the Language .....	83

## Shooting/Replaying with a TV Monitor

Shooting/Replaying with a TV Monitor .....	84
--	----

## Downloading Images to a Computer

Downloading Directly from a CF Card .....	85
Inserting the CF Card .....	85
Downloading Images .....	86
Connecting the Camera to a Computer with a USB Cable .....	87
Connecting to a USB Port .....	88

## Appendices

Care and Maintenance of the Camera .....	90
Troubleshooting .....	91
List of Messages .....	95
Specifications .....	98
Index .....	101
Canon Customer Support Help Desk .....	104

# Read This First

## Please Read

### Test Shots

Before you shoot images of subjects of importance to you, we strongly recommend that you shoot several trial images to confirm that you are operating the camera correctly. Please note that Canon Inc., its subsidiaries and affiliates, and distributors of its digital cameras are not liable for any consequential damages arising from any malfunction of the Canon digital camera or CompactFlash™ card (CF card) resulting in the failure of an image to be recorded or to be recorded in a format that is machine sensible.

### Warning Against Copyright Infringement

Please note that Canon digital cameras are intended for personal use and must be used in a manner that respects international and domestic copyright laws and regulations. Please be advised that in certain cases the copying of images from performances, exhibitions, or commercial properties by means of a camera or other device may contravene copyright or other legal rights even if the image was recorded for personal use.

### Warranty Limitations

This camera's warranty is only effective in the country of sale. If a problem arises while the camera is in use abroad, please convey it back to the country of sale before proceeding with a warranty claim to a Canon Customer Support Help Desk.

## Safety Precautions

- Before using the camera, please ensure that you have read and understood the safety precautions described below. Always ensure that the camera is operated correctly.
- The safety precautions noted on the following pages are intended to instruct you in the safe and correct operation of the camera and its accessories to prevent injuries or damage to yourself, other persons and equipment.
- In the next few pages, the term "equipment" refers primarily to the camera, battery charger and optional compact power adapter.

**⚠ WARNINGS**

- Do not aim the camera directly into the sun or at other intense light sources which could damage your eyesight.

---

- Do not trigger the flash in close proximity to human or animal eyes. Exposure to the intense light produced by the flash may damage eyesight. In particular, remain at least one meter (39 inches) away from infants when using the flash.

---

- Store this equipment out of the reach of children and infants. Accidental damage to the camera or batteries by a child could result in serious injury. In addition, placement of the wrist strap around the child's neck could result in asphyxiation.

---

- Do not attempt to disassemble or alter any part of the equipment that is not expressly described in this guide. Disassembly or alteration may result in high-voltage electrical shock. Internal inspections, alterations and repairs should be conducted by qualified service personnel authorized by your camera distributor or a Canon Customer Support Help Desk.

---

- To avoid the risk of high-voltage electrical shock, do not touch the flash portion of the camera if it has been damaged. Similarly, never touch internal portions of the equipment which become exposed as a result of damage. There is a risk of high-voltage electrical shock. Please take the first opportunity to consult your camera distributor or a Canon Customer Support Help Desk.

---

- Stop operating the equipment immediately in the event that it emits smoke or noxious fumes. Failure to do so may result in fire or electrical shock. Immediately turn the camera's power off and remove the camera battery or unplug the power cord from the electrical outlet. Confirm that smoke or fume emissions have ceased. Please consult your camera distributor or the closest Canon Customer Support Help Desk.

---

- Stop operating the equipment if it is dropped or the casing is damaged. Failure to do so may result in fire or electrical shock. Immediately turn the camera's power off and remove the camera battery or unplug the power cord from the electrical outlet. Please consult your camera distributor or the closest Canon Customer Support Help Desk.

---



- 
- Do not allow the equipment to come into contact with, or become immersed in, water or other liquids. Do not allow liquids to enter the interior. The camera has not been waterproofed. If the exterior comes into contact with liquids or salt air, wipe it dry with a soft, absorbent cloth. In the event that water or other foreign substances enter the interior, immediately turn the camera's power off and remove the camera battery or unplug the power cord from the electrical outlet. Continued use of the equipment may result in fire or electrical shock. Please consult your camera distributor or the closest Canon Customer Support Help Desk.
- 
- Do not use substances containing alcohol, benzene, thinners or other flammable substances to clean or maintain the equipment. The use of these substances may lead to fire.
- 
- Do not cut, damage, alter or place heavy items on the power adapter cord. Any of these actions may cause an electrical short circuit, which may lead to fire or electrical shock. Replace a broken or damaged power adapter cord.
- 
- Do not handle the power cord if your hands are wet. Handling it with wet hands may lead to electrical shock. When unplugging the cord, ensure that you hold the solid portion of the plug. Pulling on the flexible portion of the cord may damage or expose the wire and insulation, creating the potential for fires or electrical shocks.
- 
- Use of power sources not expressly recommended for this equipment may lead to overheating, distortion of the equipment, fire, electrical shock or other hazards. Use only the recommended power accessories.
- 
- Do not place the batteries near a heat source or expose them to direct flame or heat. Neither should you immerse them in water. Such exposure may damage the batteries and lead to the leakage of corrosive liquids, fire, electrical shock, explosion or serious injury.
- 
- Do not attempt to disassemble, alter or apply heat to the batteries. There is serious risk of injury due to an explosion. Immediately flush with water any area of the body, including the eyes and mouth, or clothing, that comes into contact with the inner contents of a battery. If the eyes or mouth contact these substances, immediately flush with water and seek medical assistance.
- 
- Avoid dropping or subjecting the batteries to severe impacts that could damage the casings. It could lead to leakage and injury.
- 
- Do not short-circuit the battery terminals with metallic objects, such as key holders. It could lead to overheating, burns and other injuries. Use the supplied battery case to transport or store the battery pack.
-

- Before you discard a battery, cover the terminals with tape or other insulators to prevent direct contact with other objects. Contact with the metallic components of other materials in waste containers may lead to fire or explosions. Discard the batteries in specialized waste facilities if available in your area.

---

- Use of batteries not expressly recommended for this equipment may cause explosions or leaks, resulting in fire, injury and damage to the surroundings. Use only recommended batteries and accessories.

---

- Use only the recommended battery charger to charge the Battery Pack NB-1L rechargeable batteries. Use of chargers not expressly recommended may result in overheating, distortion, fire or electrical shock.

---

- Disconnect the battery charger or the compact power adapter from both the camera and electrical outlet after recharging and when the camera is not in use to avoid fires and other hazards.

---

- The camera terminal of the battery charger cord and the compact power cord is designed for exclusive use with your camera. Do not use it with other products or batteries. There is a risk of fire and other hazards.

### CAUTIONS

- Avoid using, placing or storing the equipment in places subject to strong sunlight or high temperatures, such as the dashboard or trunk (boot) of a car. Exposure to intense sunlight and heat may cause the batteries to leak, overheat or explode, resulting in fire, burns or other injuries. High temperatures may also cause deformation of the casing. Ensure that there is good ventilation when using the compact power adapter to charge the battery pack or power the camera.

---

- Do not store the equipment in humid or dusty areas. Storage in such areas could lead to fire, electrical shock or other damage.

---

- Be careful not to bang the camera or subject it to strong impacts or shocks that could lead to injury or damage the equipment when wearing or holding it by the wrist strap.

---

- Be careful not to cover the flash with your fingers when shooting. In addition, do not touch the surface of the flash after taking several pictures in rapid succession. Either action could result in burns.

---

- If your camera is used for prolonged periods, the camera body may become warm. Please take care when operating the camera for an extended period as your hands may experience a burning sensation.

## Preventing Malfunctions

### **Avoid Strong Magnetic Fields**

Never place the camera in close proximity to electric motors or other equipment generating strong electromagnetic fields. Exposure to strong magnetic fields may cause malfunctions or corrupt image data.

### **Avoid Condensation Related Problems**

Moving the equipment rapidly between hot and cold temperatures may cause condensation (water droplets) to form on its external and internal surfaces. You can avoid this by placing the equipment in an airtight, resealable plastic bag and letting it adjust to temperature changes slowly before removing it from the bag.

### **If Condensation Forms Inside the Camera**

Stop using the camera immediately if you detect condensation. Continued use may damage the equipment. Remove the CF card and battery or power cord (if connected) from the camera and wait until the moisture evaporates completely before resuming use.

### **Extended Storage**

When not using the camera for extended periods of time, remove the battery pack and store the equipment in a safe place. Storing the camera for extended periods with a battery pack installed will run down the battery pack and may damage the camera. Please note, however, that the date, time and other camera settings may reset to the default settings if the battery pack has been removed for more than three weeks. Follow the instructions in this guide to reset the desired settings.

# Quick Start

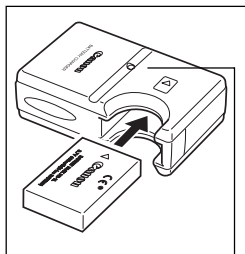

Charge Indicator

## 1 Charge the Battery Pack (→ p. 15)

Place the battery pack in the battery charger and plug the charger into the electrical outlet. The charge indicator will glow orange while the battery pack is charging and change to green when it is fully charged.

- Please note that the battery charger shape varies between regions.

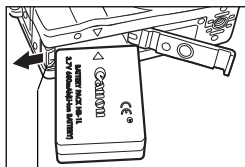

Battery Lock

## 2 Install the Battery Pack (→ p. 17)

Slide the battery cover to open it and press the battery lock while inserting the battery pack all the way in.

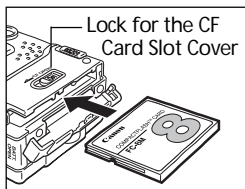

## 3 Install a CF Card (→ p. 20)

Slide the lock down and open the CF card slot cover. Insert the CF card.

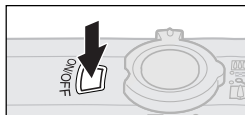

## 4 Turn the Power On (→ p. 24)

Press and hold the main switch until the green indicator blinks.

- If the Set Date/Time menu appears, set the date and time (p. 22).

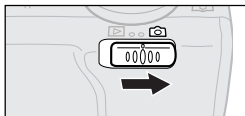

- 5** Slide the mode switch to  (shooting) (→ p. 25).

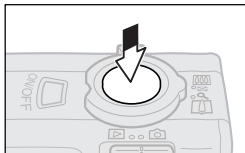

- 6** Focus (→ p. 32)

Aim the camera at the subject and press the shutter button halfway. The camera will focus automatically and beep twice.

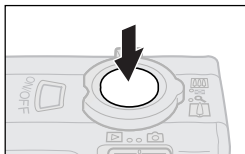

- 7** Shoot (→ p. 32)

Press the shutter button down fully. One beep will sound when the image has been shot.



- 8** View the Image (→ p. 33)

The image you shoot will appear in the LCD monitor for approximately 2 seconds. If you keep the shutter button held down and press the **SET** button, the image will remain displayed even if you release the shutter button.

- To view all of the images that you have shot, please read the Replaying section (p. 52).
- After you finish using the camera, press the main switch to turn off the power.

# Preparing the Camera

## Guide to Components

### Front View

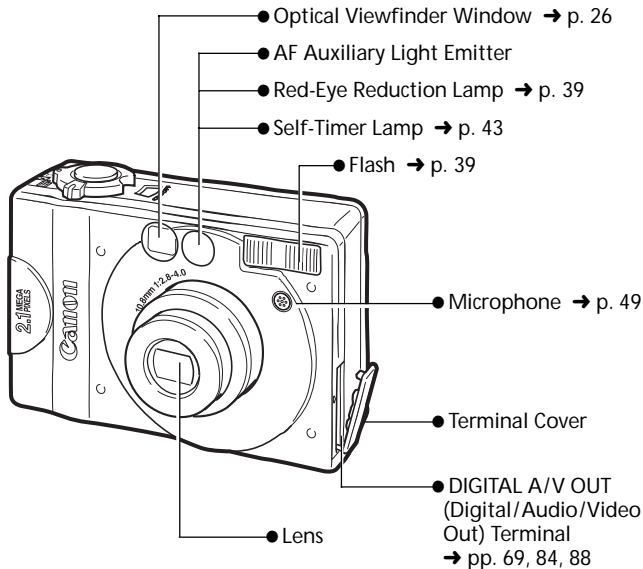

\* To connect Card Photo Printer CP-10 (Optional), use the direct interface cable provided with the printer. To connect a computer, use the USB interface cable supplied with the camera. Use the supplied AV cable to connect to a TV.

## Back View

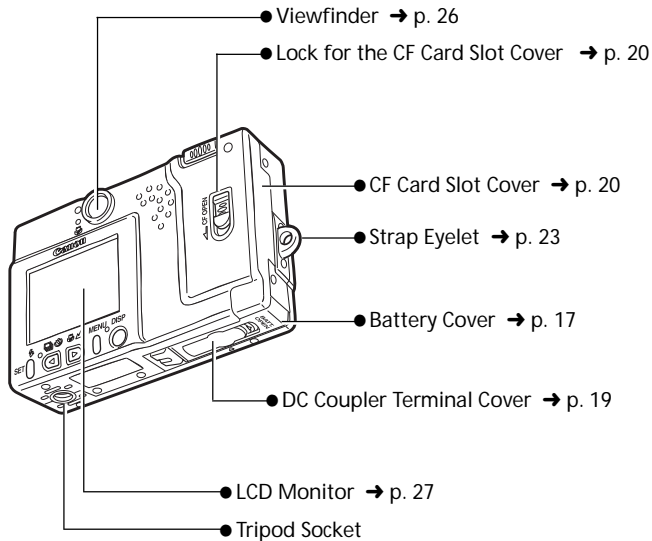

## Operation Panel

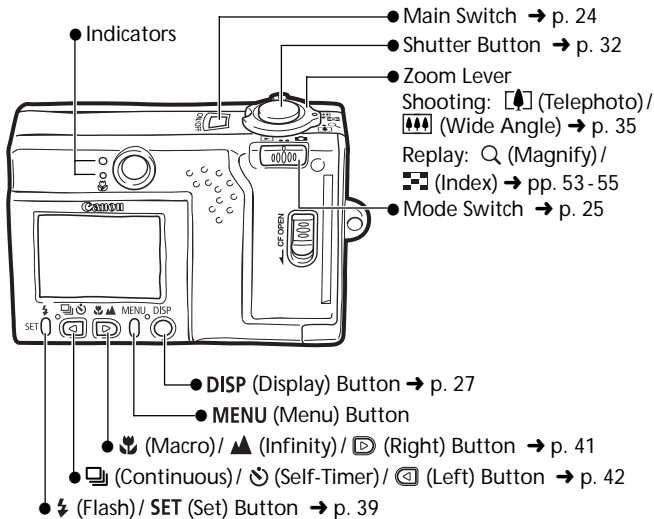

### Indicators

- The indicators will glow or flash at various stages when the main switch or shutter button is pressed.

#### Upper Indicator

Green:	Ready to record/Connection preparations complete (in PC mode)
Flashing Green:	During camera warm-up/Recording to CF card/Reading CF card/Deleting CF card images/Transmitting images to or from a CF card (while connecting to a computer)
Orange:	Ready to record with flash
Flashing Orange:	Ready to record but the camera blur warning is flashing

#### Lower Indicator

Yellow:	Macro mode
---------	------------



## Charging the Battery Pack

Recharge the battery pack with battery charger CB-2LS or CB-2LSE the first time you use the camera or when the "Change the battery pack" message is displayed.

**Battery charger model names and types vary by region.**

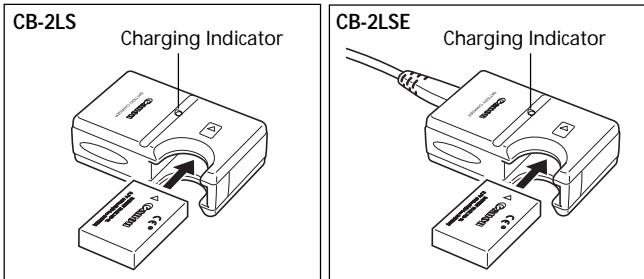

- Insert the battery pack all the way into the battery charger and plug the charger into an electrical outlet.
- The charging indicator will glow orange while the battery pack is charging. It will change to a steady green when the charge is complete.
- After charging, unplug the battery charger and remove the battery pack from it.

- Since this is a lithium ion battery pack, you need not completely use or discharge it before recharging.
- It takes approximately 130 minutes to fully charge the battery pack from a fully discharged state (based on standard Canon testing conditions). Please charge it at an ambient temperature ranging between 5 and 40 °C (41 and 104 °F).
- Charge times may vary according to the ambient temperature and the charge state of the battery pack.

- To protect and prolong the life of the battery pack, do not charge it for longer than 24 hours at a time.

## Handling Precautions

- Do not rapidly overturn or wave the battery charger around when the battery pack is in it. There is a danger of the battery pack flying out.
- At low temperatures, the battery pack performance may be reduced and the low battery icon may appear earlier than usual. Under these conditions, resuscitate the battery pack by warming it in a pocket immediately before use. However, ensure that there are no metallic items in the pocket that could cause the battery pack to short circuit, such as key holders, etc.
- Do not place anything, such as tablecloths, carpets, bedding or cushions, on top of the battery charger while it is charging. Heat will build up and could result in a fire.
- Do not charge batteries other than Battery Pack NB-1L in this charger.
- The battery pack continues to discharge a minimal portion of its power while installed in the camera, even with the camera power off or inserted into the battery charger. This will shorten battery life. To conserve the battery pack, store it in its case in a cool, dry place. Recharge it fully before using it again.
- If the performance of the battery pack diminishes substantially even when it is fully charged, the battery pack should be replaced.

## Installing the Battery Pack

Install Battery Pack NB-1L (supplied) as shown below.

- Please recharge the battery pack ( p. 15) before you use it for the first time.



- Slide the battery cover in the direction of the arrows.

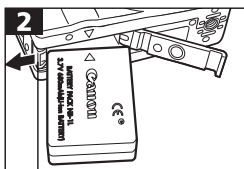

Battery Lock

- Press the battery lock while inserting the battery pack all the way in until the lock clicks.
- To remove the battery pack, press the battery lock and pull the battery pack out.

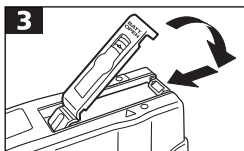

- Slide the battery cover closed.

- When the camera's indicator flashes green, do not turn off the power or open the battery cover. The camera is writing, reading, erasing or transmitting an image to or from the CF card.
- Remove the battery pack from the camera when the camera is not in use. Please note, however, that the date, time and other camera settings may reset to the default settings if the battery pack has been removed for more than three weeks.

- Please use a household power source for extended use of the camera (p. 19).

## Battery Performance

	Recordable Images		Replay Time
	LCD Monitor On	LCD Monitor Off	
Battery Pack NB-1L (fully charged)	Approx. 120 shots	Approx. 270 shots	Approx. 85 min.

- The actual performance may vary from the above data according to the shooting conditions and the shooting mode.
- Excludes movie data.
- At low operating temperatures, the battery performance may drop and the low battery icon may appear sooner than at high temperatures. To improve performance at these temperatures, warm the battery in your pocket just before using it in the camera.





### <Test Conditions>

Shooting: Room temperature (23°C, 73°F), alternating between wide angle and telephoto every 20 seconds, flash used one in four shots, power turned off and on again after every eighth shot

Replay: Room temperature (23°C, 73°F), continuous replay at 3 seconds per image

## Battery Pack Charge

The following icons and messages will display when the charge of the battery pack is low.

	Battery pack charge is low. Recharge it as soon as possible before it is required for an extended period. When the LCD monitor is off, this icon will display when you press the  ,  ,  or  button.
Change the battery pack	Battery charge is insufficient to operate the camera. Replace the battery pack immediately.

## Using a Household Power Source

It is best to power the camera with AC Adapter Kit ACK500 (sold separately) when you are using it for long periods of time or connecting it to a computer.

- Turn the camera power off before connecting or disconnecting the AC adapter.

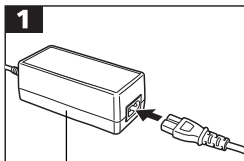

Compact Power Adapter  
CA-PS500

- Connect the power cord to the compact power adapter first and then plug the other end into the electrical outlet.

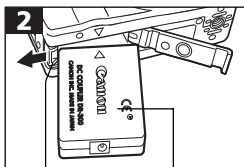

Battery Lock      DC Coupler  
Lock              DR-500

- Open the battery cover and press the battery lock in the direction shown while inserting DC Coupler DR-500. Insert the DC coupler all the way in until the battery lock clicks. Slide the battery cover closed.

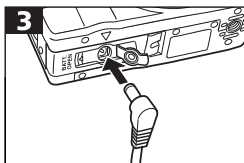

- Open the DC coupler terminal cover and attach the cord to the DC terminal.
- After you have finished using the camera, unplug the AC adapter from the electrical outlet.

- Use of an AC adapter kit other than ACK500 may cause a malfunction in the camera or kit.

## Installing a CF Card

Turn the camera power off and insert the CF card with the following procedures.

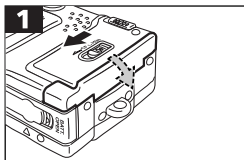

- Slide the lock down and open the CF card slot cover.

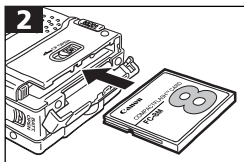

- Insert the CF card until the slot's eject button fully extends. Close the CF card slot cover.



CF Card Eject Button













- To remove the CF card, push the eject button and pull the CF card out.







- When the camera's indicator flashes green, do not turn off the power or remove the CF card. The camera is writing, reading, erasing or transmitting an image to or from the CF card.
- Please note that CF cards from other manufacturers, or CF cards which have been edited with application software using other formats, may not operate correctly in the camera.

## Handling Precautions for CF Cards

- CF cards are high-precision electronic devices. Do not bend them, apply force to them, or subject them to shocks or vibration.
- Do not attempt to disassemble or alter a CF card.
- Moving a CF card rapidly between temperature extremes will cause condensation to form in the card and lead to a malfunction. To avoid condensation, place the CF card in a sealed plastic bag before moving it into a different temperature zone and allow it to adjust slowly to the new temperature. If condensation forms on the CF card, store it at room temperature until the water droplets have evaporated naturally.
- Place the CF card in the supplied case for storage.
- Do not use or store CF cards in the following types of location.
  - Location subject to dust or sand
  - Locations subject to high humidity and high temperatures

## CF Cards and Estimated Capacities (Recordable Images)

		FC-8M	FC-16M	FC-32M	FC-64M	FC-128M
<b>L</b> (1600 x 1200 pixels)		7	15	31	64	128
		11	24	49	100	200
		24	48	99	200	401
<b>M</b> (1024 x 768 pixels)		16	32	67	135	271
		24	49	102	205	412
		46	92	189	379	760
<b>S</b> (640 x 480 pixels)		35	70	143	288	577
		50	99	206	415	831
		87	172	353	707	1417
MOVIE	 (640 x 480 pixels)	6 sec.	13 sec.	27 sec.	56 sec.	113 sec.
	 (320 x 240 pixels)	18 sec.	36 sec.	75 sec.	152 sec.	305 sec.
	 (160 x 120 pixels)	48 sec.	97 sec.	198 sec.	399 sec.	799 sec.

- These figures reflect standard shooting conditions established by Canon. Actual totals may vary according to the subject, shooting conditions and shooting mode.
- The maximum length of a movie clip recording is approximately: 4 seconds () , 10 seconds () or 30 seconds () . The times shown are the maximum continuous recording times.
- **L** (Large), **M** (Medium), **S** (Small), , ) and ) indicate the recording resolution.
-  (Superfine),  (Fine) and  (Normal) indicate the compression setting.

## Setting the Date and Time

- The Set Date/Time menu will appear the first time the camera power is turned on or whenever the built-in rechargeable lithium battery charge is low. Start from Step 5 to set the date and time.

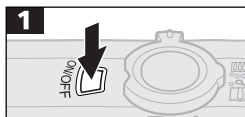

- Press and hold the main switch until the green indicator blinks.

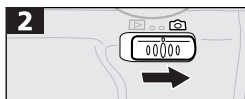

- Press the **MENU** button several times until the Rec. menu displays (p. 30).
- Use the **◀** or **▶** button to select the **⏸** icon.



- Use the **◀** or **▶** button to select the **⌚** icon.



- The Set Date/Time menu will display.
- Select a field (month, day, year, hour, minutes and date format) with the **SET** button.
- Use the **◀** or **▶** button to change the value in a field.
- The factory default for the date format in some regions may differ from that shown.





- After you select the date format, the date format will take effect when you press the **SET** button.



- The LCD monitor will return to the shooting mode.

- Please note that the date and time settings may reset to the default settings if the camera battery has been removed for more than three weeks. Reset them when this occurs.

## Attaching the Wrist Strap

Thread the small loop of the wrist strap through the strap holder on the camera and pull the large loop through the small loop until the small loop fits snugly against the strap holder.

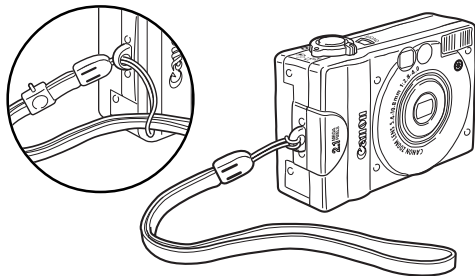



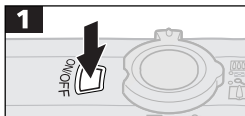

- Be careful not to wave the camera about or catch it on other items when dangling it from the wrist strap.

## Basic Functions

### Turning the Power On/Off



Press and hold the main switch until the green indicator blinks.

- The lens will extend when the mode switch is set to .
- The lens will retract approximately 1 minute after the mode switch is set to  from .
- The LCD monitor will turn on regardless of its On/Off status when the mode switch is set to .

Press the main switch again to turn off the power.

- The Set Date/Time menu will appear the first time the camera is turned on. Please set the date and time (p. 22).
- If the auto power down function activates, press the main switch again to restore power.

### Auto Power Down Function

The camera is equipped with an auto power down function (p. 81). It will power down when the auto power down function is set to On under the following circumstances.

- Shooting: shuts down approximately 3 minutes after the last action.
- Replaying: shuts down approximately 5 minutes after the last action (excluding auto replay mode).
- Connected to Card Photo Printer CP-10 (optional): shuts down approximately 5 minutes after the last action involving the camera or printer.
- Connected to a computer: (auto power down always active) a warning message displays on the computer approximately 5 minutes after the last action and the camera shuts down after an additional 1 minute without action.

## Switching between the Shooting/Replay Modes

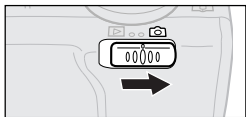

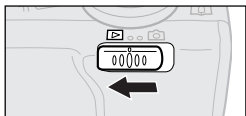

### Shooting

Slide the mode switch to the  position.



### Replay

Slide the mode switch to the  position.

- You should also slide the mode switch to  to print an image with Card Photo Printer CP-10 (optional) (p. 70).
- You should also slide the mode switch to  to download or view images on the computer (p. 89).

- The  (direct print) icon will display in the LCD monitor when the connection to Card Photo Printer CP-10 (optional) is complete.
- The LCD monitor will shut off and the indicator will glow green when the connection to a computer is complete.

## Using the Viewfinder

This camera is equipped with an optical viewfinder.

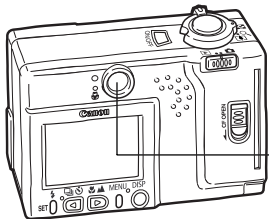

Align the square brackets (autofocus metering field) inside the viewfinder on the primary subject to compose the image.

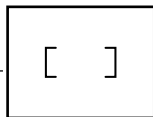

Viewfinder

### About the Autofocus Function

This camera employs AiAF (artificial intelligence autofocus) technology which uses a broad metering field to calculate the focal distance with high precision. It delivers a crisp focus even when the photographic subject is slightly off-center.

### Using the Focus Lock

The following types of subject may not be suited to autofocus photography. Use the focus lock in these situations.

- Subjects with extremely low contrast to the surroundings
- Subjects with extremely bright objects at the center of the composition
- Subjects that are moving quickly
- Subjects through glass

Try to shoot as close to the glass as possible to reduce the chances of light reflecting back off the glass.

#### How to Use the Focus Lock

1. Aim the camera so that a subject at the same focal distance as the main subject is centered in the brackets in the optical viewfinder.
2. Press the shutter button halfway and wait until two beeps sound.
3. Re-aim the camera to compose the shot as desired and press the shutter button all the way.

## Using the LCD Monitor

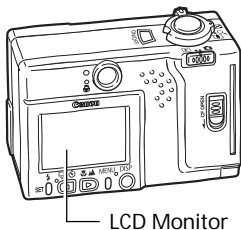

The LCD monitor can be used to compose images while shooting, adjust settings menus and replay images.

- The image in the LCD monitor will darken in strong sunlight or bright light. This does not constitute a malfunction.

## Shooting Mode (Mode switch set to )



- Pressing the **DISP** button turns the LCD monitor on or off.

- The LCD monitor setting (On or Off) is saved by the camera when the power is turned off so that the same setting is automatically available when the power is turned on again. However, the setting may be lost when the power has been turned off after the "Change the battery pack" message has displayed, while the LCD monitor was on in shooting mode.
- In macro mode, the parallax phenomenon may cause images composed with the viewfinder to be off-center. Use the LCD monitor to compose close-ups in macro mode (p. 41).

- Set the flash to On or affix the camera to a tripod when the upper indicator flashes orange and the camera blur warning icon () appears in the LCD monitor after the metering preparations are complete.

## Replay Mode (Mode switch set to )



- The LCD monitor will turn on when the mode switch is set to the  position.
- In replay mode, pressing the **DISP** button cycles between display modes.



Single Image Replay ..... Standard → Detailed → No Display  
 Index Replay (9 Images) ..... Standard → No Display

## Information Displayed on the LCD Monitor

### Shooting Mode

In shooting mode, information about the current settings and remaining image capacity will display on the LCD monitor for approximately six seconds when the actions below are taken, regardless of whether the LCD monitor is set to On or Off.

While this information is displayed, you may set the flash, continuous mode, self-timer, macro and infinity settings.



























- The power is turned on.
- The **DISP**, , , or  button is pressed.
- The camera settings are changed.
- The Rec. menu is closed.
- The shutter button has been pressed and a shot has been taken.  
 (LCD monitor must be on)

The resolution, but not compression, shows in movie mode.



Remaining Image Capacity  
 (Recordable seconds remaining  
 for movies)

### Information Displayed

Shooting Mode	    	p. 36
Exposure Compensation	-2 ... ±0 ... +2	p. 44
White Balance	     	p. 45
Compression	  	p. 37
Resolution	<b>L</b> <b>M</b> <b>S</b> 640 320 160	p. 37
Flash	     	p. 39
Shooting Method	  	p. 42
Macro/Infinity	 	p. 41
Zoom Setting*	x2.5/x3.1/x4.0/x5.0	p. 35
Camera Blur Warning		p. 27

\* The displayed zoom setting is the combined effect of the optical and digital zooms. It displays when the digital zoom is activated.

## Replay Mode (Standard Display)



In standard display mode, the following information is displayed.

- File Number
- Image Number (Image Number/Total Number of Images)
- Shooting Date
- Compression (S, M, L)
- Resolution (L, M, S, 640, 320, 160)
- Movie (AVI)
- Protection Status (On)

## Replay Mode (Detailed Display)



In detailed mode, the following supplementary information is displayed.

Shooting Mode		p. 36
Macro/Infinity		p. 41
Shooting Method		p. 42, 43
Flash		p. 39
Exposure Compensation		p. 44
White Balance		p. 45

The following information may also be displayed with some images.

	A sound file (WAVE file) is attached.
	A sound file in a format other than the WAVE format is attached or the file format is not recognized.
	JPEG file with format not conforming to Design rule for Camera File system standards
	RAW format file
	File with unrecognized format

- The image information may not display correctly if images shot with this camera are replayed on other cameras or images from other cameras are replayed on this camera.

## LCD Monitor Menus / Switching between Display Modes

### Shooting (Mode switch set to )

The following menus will show on the LCD monitor according to the selected shooting mode.

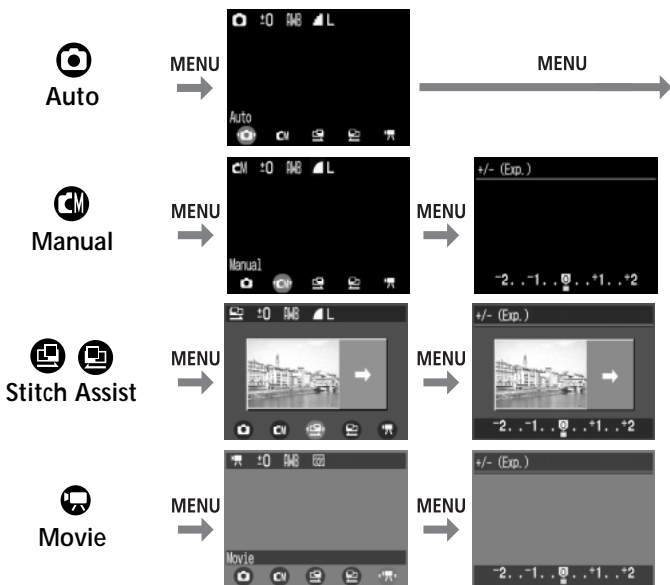

### Replay (Mode switch set to )

You can switch between display modes with the zoom lever.



Zoomed View



Entire Image  
(Single Image Replay)





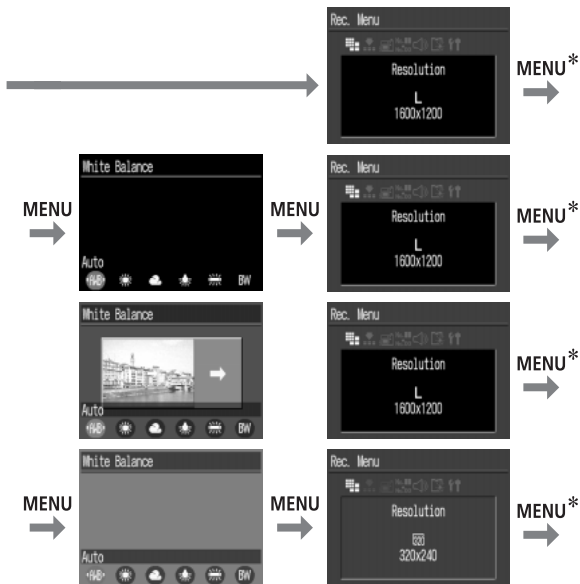

\* Closes the Setup menu and prepares the camera for shooting.



Displays Nine Images  
(Index Replay)



Switches between  
Sets of Nine Images

## Pressing the Shutter Button

The shutter button features a two-stage action.

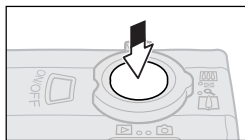

### Pressing Halfway

The camera uses the first stage to automatically set the exposure, autofocus and white balance. When it has finished metering, two beeps sound and the upper indicator glows green.

When the flash is used, the indicator glows orange when the flash is ready to fire. A flashing orange indicator warns of insufficient light and the risk of camera blur.



Indicator

In macro mode, the lower indicator glows yellow.

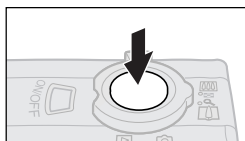

### Pressing Fully

Pressing the shutter button down fully activates the shutter and causes one beep to sound. While the image is being recorded to the CF card, the indicator flashes green.

- Recorded images are temporarily stored in the camera's internal memory and then written to the CF card. The next image can be recorded immediately after the first as long as sufficient internal memory is available.

## Reviewing an Image Immediately after Recording It

Images display in the LCD monitor (regardless of its On/Off status) for 2 seconds immediately after recording even if you release the shutter button. Images can also be reviewed with the following procedures.

### Continuing to Press the Shutter Button Fully

If you continue to press the shutter button fully after shooting, the image will display until the button is released.

### Pressing the SET Button

If you press the SET button while continuing to press the shutter button fully, it will continue to display even when you release the shutter button. To cancel the review, press the shutter button halfway.

- You can erase an image right away while it is displayed (p. 52).

## Changing the Default Review Setting

The default review time is approximately 2 seconds. This can either be turned off or set to approximately 10 seconds.

1

Display the Rec. menu  
(→ p. 77)



2

SET [REVIEW] MENU DISP

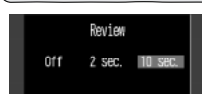

3

SET [REVIEW] MENU DISP



• [REVIEW] is not available in the [VIEW] modes.

- Use the [LEFT] or [RIGHT] button to select the [REVIEW] icon.
- Use the [LEFT] or [RIGHT] button to select Off, 2 sec. or 10 sec.
- No image will display when the review function is set to Off unless you continue to press the shutter button fully after shooting.
- With the 2- or 10-second options, the image will display for the specified time even if the shutter button is released right after shooting.
- With the 2- or 10-second options, you can display the image for longer than the specified time as long as the shutter button is held down continuously.
- You can shoot another image even while an image is displayed.

## Adjusting the Zoom (Angle of View)

The zoom can be adjusted to any setting in the 35 to 70 mm range in 35 mm film equivalent terms.

### Telephoto/Wide Angle



Pressing  (telephoto) on the zoom lever zooms in, making the subject appear larger in the composition.



Pressing  (wide angle) on the zoom lever zooms out, making the subject appear smaller in the composition.

### Digital Zoom

When the LCD monitor is on, you can digitally zoom in on a subject with the zoom lever once it is at the maximum optical telephoto setting. Images can be zoomed up to 5 times, which combines the effect of the optical zoom.

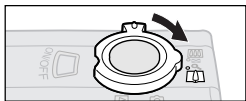

The displayed zoom setting is the combined effect of the optical and digital zooms.

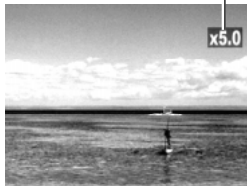



Press  on the zoom lever until it reaches the maximum telephoto setting and stops.

Press  on the zoom lever again to further zoom the image.

Press  on the zoom lever to zoom back out.





- Please note that the image appears grainier, the more the image is digitally zoomed.

- The digital zoom is not available when the LCD monitor is set to Off or the shooting mode is set to , , or .



# Shooting

## Selecting a Shooting Mode

The camera features the following shooting modes.

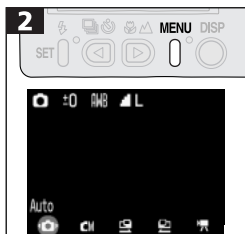
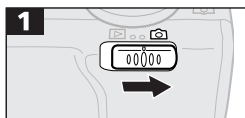
	Auto	Most settings are automatically selected by the camera.
	Manual	The exposure compensation, white balance and other settings can be manually selected.
	Stitch Assist	Images are shot in overlapping series to create single panoramic images.
	Movie	Shoots movie clips.





- Use the  or  button to select a shooting mode.





- The settings selected for each shooting mode remain effective even when you switch between shooting modes. When the power is turned off, the settings are also retained for certain shooting modes, but not for others (p. 51).



## Changing Resolution/Compression Settings

Still image resolution and compression settings and movie resolution settings can be adjusted to suit your requirements. Resolution settings get progressively higher ranging from the **S** (Small) and **M** (Medium) to the **L** (Large) settings. Use a high resolution setting to obtain the best quality for printing an image at a large size, but select a lower one to print on small labels, to send images by email or to fit more images on a CF card. Compression settings yield progressively higher image quality as one switches from the  (Normal) and  (Fine) to the  (Superfine) setting.

Still Image Resolution	
<b>L</b> (Large)	1600 x 1200 pixels
<b>M</b> (Medium)	1024 x 768 pixels
<b>S</b> (Small)	640 x 480 pixels





Compression	
	Superfine
	Fine
	Normal



The following resolutions are available for movies.

Movies Resolution	
	640 x 480 pixels
	320 x 240 pixels
	160 x 120 pixels

**1**





Select a Shooting Mode  
(→ p. 36)

- Set the shooting mode to , , ,  or .

 cannot be adjusted in  mode.

**2**



- Press the **MENU** button repeatedly until the Rec. menu appears (p. 30).
- Use the  or  button to select  or  for still images or  for movies.



### Resolution (Still Images)

Select [1600 x 1200], [1024 x 768] or [640 x 480].



### Resolution (Movies)

Select [640 x 480], [320 x 240] or [160 x 120].

### Compression

Select [Superfine], [Fine] or [Normal].



- Use the or button to select a setting.
- The LCD monitor will return to the shooting mode.

## Approximate Image Sizes





Resolution	Compression		
<b>L</b> (1600 x 1200 pixels)	957 KB	611 KB	302 KB
<b>M</b> (1024 x 768 pixels)	450 KB	294 KB	155 KB
<b>S</b> (640 x 480 pixels)	208 KB	141 KB	79 KB
<b>640</b> (640 x 480 pixels)		900 KB/s	
Movies <b>320</b> (320 x 240 pixels)		380 KB/s	
<b>160</b> (160 x 120 pixels)		130 KB/s	

- These figures reflect standard shooting conditions established by Canon. Actual totals may vary according to the subject and shooting conditions.

• Please see page 21 for the available CF cards and their capacities.

















## ⚡ Using the Flash

	Red-Eye Reduction Auto	The main flash may fire automatically as required by the light level. The red-eye reduction lamp fires whenever the flash fires.
	Auto	The flash fires automatically as required by the light level.
	On	The flash fires with every shot.
	Off	The flash will not fire.
	Slow-Synchro	The flash timing is adjusted to slow shutter speeds. This reduces the chance that the background will be dark when shots are taken at night or in rooms with artificial lighting. The red-eye reduction lamp fires with each shot. Use of a tripod is recommended.

1

Select a Shooting Mode  
(→ p. 36)

- Set the shooting mode to , ,  or .

			 	
	●	●	–	–
	●	●	–	–
	–	●	▲	–
	●	●	▲	●
	–	●	▲	–

- Setting available.
- ▲ Can be selected for first image only.

2



- Press the  button to cycle through the flash settings.





- The flash can be fired when the upper indicator glows a steady orange.
- The flash takes approximately 10 seconds to charge. Recharging time may vary with the state of the battery charge.



Please note that a slow shutter speed will be selected in dark places when the flash is set to off or slow-synchro. Be careful to avoid camera blur under these conditions.

- **Shooting in  Mode**

Be careful to hold the camera still to avoid camera blur.

- **Shooting in ,  or  Mode**

Fix the camera to a tripod to shoot in the ,  or  mode since the shutter speed will be slower than in the  mode.



If an image is dark in  mode, reshooting it in  mode will make it brighter.

- The flash fires twice. A preparatory pre-flash is followed by the main flash. The exposure readings obtained from the subject with the pre-flash are used to set the optimal flash intensity for the main flash, which is used to shoot the image.

## Red-Eye Reduction





- Light reflecting back from eyes can make them appear red when the flash is used in dark areas. Under these conditions, use the red-eye reduction mode. For this mode to be effective, the subject must be looking right at the red-eye reduction lamp. Try asking them to look directly at the lamp. Even better results can be obtained by shooting with the lens set to the wide angle, increasing the lighting in indoor settings or approaching closer to the subject.
- To improve the effect of the red-eye reduction lamp, the camera will not shoot for approximately 1 second after the shutter button is fully pressed. If you wish to shoot immediately, set the flash to any one of the auto, on or off settings.







## / Shooting Close-Ups/Infinity Shots

	Macro Mode	Use this mode to record subjects in the range of 10 to 57 cm (3.9 in. to 1.9 ft.) from the lens tip when at maximum wide angle and in the range of 27 to 57 cm (10.6 in. to 1.9 ft.) when at the maximum telephoto setting.
	Infinity Mode	Use this mode to record landscapes and distant objects. It can also be used for compositions combining both near and distant objects.

**1**

Select a Shooting Mode  
(→ p. 36)

- Set the shooting mode to , , ,  or .

			 	
	●	●	▲	●
	-	●	▲	●

- Setting available.
- ▲ Selectable for first image only.

**2**

- Display  or .

- Use the LCD monitor to compose close-ups in macro mode since the parallax phenomenon may cause images composed with the optical viewfinder to be off-center.
- The exposure may not be optimal when the flash is used in macro mode in the range of 10 to 27 cm (3.9 to 10.6 in.).

## Shooting Continuously

**1**

Select a Shooting Mode  
(→ p. 36)

**2**

- Set the shooting mode to .

- Display .
- The camera will shoot continuously at approximately 2.5 images per second\* (Large and Fine settings with the LCD monitor off) while the shutter button is held down. Recording ceases when the shutter button is released.





\* This figure reflects standard shooting conditions established by Canon. Actual figures may vary according to the subject and shooting conditions.

- Images may be recorded consecutively in continuous mode until the CF card is full.
- The interval between shots lengthens slightly when the camera's internal memory becomes full.
- Since the flash requires time to recharge, the interval between shots lengthens when the flash is used.

## 🕒 Using the Self-Timer

**1**

Select a Shooting Mode  
(→ p. 36)

- Set the shooting mode to , , ,  or .

**2**

- Display .
- When the shutter button is pressed, the self-timer indicator will flash and the shutter will activate after 10 seconds. The self-timer indicator will flash at a faster rate two seconds before the picture is taken.





- To cancel partway through, press the  button.
- Please see Step 4 on page 49 to learn how to stop shooting a movie clip.

## Adjusting the Exposure Compensation



An image can be under-exposed if the subject is backlit or positioned in a bright location. Lights in night shots may also appear too bright. To avoid under-exposing the image, use the exposure compensation function.

**1**

Select a Shooting Mode  
(→ p. 36)

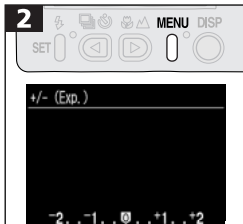
- Set the shooting mode to , ,  or .







**2**

- Press the **MENU** button repeatedly until the Exposure Compensation menu appears (p. 30).
- Use the  or  button to select a setting.
- You can confirm the effect of the exposure compensation setting in the LCD monitor image when the LCD monitor is on.
- A shot can be taken immediately after. The menu will reappear after the shot, allowing you to adjust the setting.

**3**





## Setting the White Balance

Setting the white balance to match the dominant light source when shooting will adjust the coloring of the image (excluding **BW** images) to the correct settings for the prevailing light conditions.

	Auto	The camera sets the white balance automatically.
	Daylight	Use this setting for recording outdoors on a bright day.
	Cloudy	Use this setting to record in shade or under overcast or twilight.
	Tungsten	Use this setting for recording under tungsten lighting.
	Fluorescent	Use this setting to record under fluorescent lighting.
	Black and White	Use this setting to record black and white images.



1

Select a Shooting Mode  
(→ p. 36)

- Set the shooting mode to , ,  or .

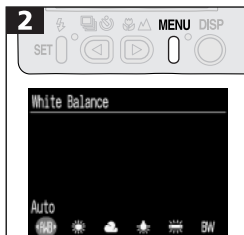
2



- Press the **MENU** button repeatedly until the White Balance menu appears (p. 30).
- Use the  or  button to select a setting.
- You can confirm the effect of the setting adjustment in the LCD monitor image when the LCD monitor is on.
- A shot can be taken immediately after. The menu will reappear after the shot, allowing you to adjust the setting.

3



## Shooting in Stitch Assist Mode

Stitch Assist mode can be used to shoot images, which overlap, and which can later be merged to create one panoramic image on a computer.

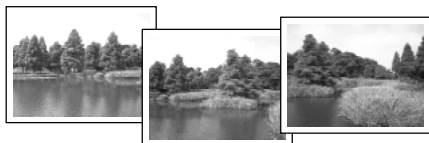

The overlapping seams of several adjacent images can be joined into a single panoramic image.

- To merge the images on the computer, use PhotoStitch, one of the supplied programs.

## Framing a Subject

The PhotoStitch program detects the overlapping portions of adjoining images and merges them. When shooting, try to include a distinctive item (landmark) in the overlapping portions.

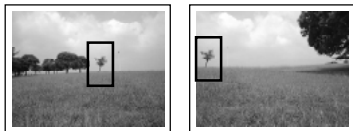

- Compose each frame so that it overlaps 30 to 50% of the adjoining image. Try to keep the vertical misalignment to less than 10% of the image height.
- Do not include moving items in the overlap.
- Do not try to stitch images that include both distant and close items. Objects may appear warped or doubled up.



- Make the brightness in each image consistent. The final image will appear unnatural if the difference in brightness is too great.

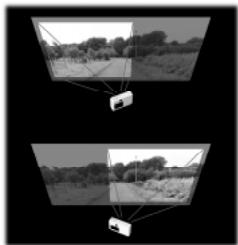

For good results, pan (swivel) the camera to take successive shots.

To shoot close-ups, slide the camera over the subject, keeping it parallel as you move.

## Shooting

Images can be shot in two sequences.

	Left → Right	Left to right horizontally
	Left ← Right	Right to left horizontally

**1**

Select a Shooting Mode  
(→ p. 36)

- Set the shooting mode to or .
- The LCD monitor will turn on.



Left to right horizontally

**2**



**3**

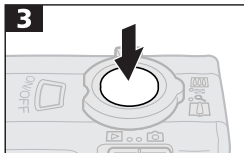

- Shoot the first frame in the series.
- The exposure and white balance settings are set and locked with the first image. Successive images use the same settings.

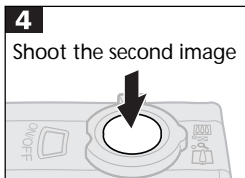

- Compose the second image so that it overlaps a portion of the first and shoot.



- Pressing the or button allows you to check the images that have been recorded.

• Minor discrepancies in the overlapping portions can be corrected when the images are stitched together.



- Repeat the procedure for additional images. A sequence may contain up to 26 images.



- Press the **SET** button to close Stitch Assist mode.

• The zoom, flash (//), self-timer, resolution, compression, exposure compensation, white balance and macro/infinity mode (/) settings can only be adjusted for the first image. Additional images from the second shot onward are shot with the same settings as the first.

- The digital zoom, certain flash settings (/) and continuous shooting mode cannot be used with the Stitch Assist mode.
- A TV monitor cannot be used when shooting in Stitch Assist mode.

## 🎥 Shooting a Movie

Use the movie mode to shoot movie clips.

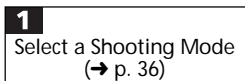

- Set the shooting mode to .
- The LCD monitor will turn on.



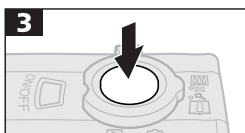

- The available recording time (seconds) will display.

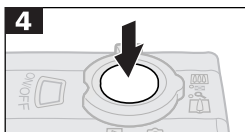

- Press the shutter button fully to start recording images and sounds.
- A red dot and recorded time (in seconds) will appear on the LCD monitor while recording is in process.























- The maximum length of a movie clip (at approximately 20 frames/second) is approximately 4 seconds () , 10 seconds () or 30 seconds () (according to standard Canon testing conditions). These times may vary with the subject and shooting conditions. Recording will automatically stop when the maximum time is reached or when the CF card runs out of free capacity.
- Recording will stop when the shutter button is pressed again while a movie is recording.

- Be careful not to touch the microphone while recording.
- The exposure compensation, focus, white balance and zoom settings remained fixed at the values selected for the first frame.
- After a clip is shot, the upper indicator will flash green while the clip is being written to the CF card. You cannot shoot until the flashing stops.
- The digital zoom, flash, continuous shooting mode and compression settings cannot be selected for movies.

- Three resolution settings (640 x 480 pixels, 320 x 240 pixels, 160 x 120 pixels) are available for movies (p. 37).
- Sound is recorded monophonically.
- The beep will not sound in the middle of a movie clip recording.
- QuickTime 3.0 or a later version of this software is required to replay movie files (AVI file format, Motion JPEG compression format) on a computer.

## Functions Available in Each Shooting Mode

The chart below is a reference for the settings available for various shooting conditions. The settings selected in each shooting mode are saved when switching between shooting modes.

Function	 Auto	 Manual	 Stitch Assist	 Movie	Reference Page
Digital Zoom	●	●	–	–	p. 35
Red-Eye Reduction Auto 	●*	●*	–	–	p. 39
Flash					
Auto 	●	●	–	–	
On 	–	●	▲	–	
Off 	●	●	▲*	●	
Slow-Synchro 	–	●	▲	–	
Resolution					p. 37
Large 	●*	●*	▲*	●	
Medium 	●	●	▲	●*	
Small 	●	●	▲	●	
Compression					p. 37
Superfine 	●	●	▲	–	
Fine 	●*	●*	▲*	–	
Normal 	●	●	▲	–	
Shooting Method					p. 42
Single 	●*	●*	▲*	●*	
Continuous 	–	●	–	–	
Self-Timer 	●	●	▲	●	p. 43
Macro Mode 	●	●	▲	●	p. 41
Infinity Mode 	–	●	▲	●	p. 41
Exposure Compensation	–	●	▲	●	p. 44
White Balance	–	●	▲	●	p. 45

\* Default value.

● Setting available.

▲ Selectable for first frame only.

■ : The settings are saved when the power is turned off.



# Replaying

## Displaying Images Singly (Single Image Replay)



- The last recorded image will appear in the display (single image replay).



- Press the  button to switch the display to the previous image. The  button switches to the next image. Hold down the button to advance through the images more rapidly. Images will appear coarser at the faster speed.

## Erasing Shortcut for the Displayed Image

- Hold the **SET** button down and press the  button while the image is displayed.
- Use the  button to select [OK].
- Press the **SET** button.



- A TV can also be used to replay images (p. 84).

## Zooming an Image







- An image can be magnified approximately 2.5 times in the single image replay mode.



Approximate  
Location of the  
Magnified Area



- Press the  or  button to move the selection area left or right and hold the **SET** button while pressing the  or  button to move the selection area up or down.
- Press  on the zoom lever to return to single image replay mode.

- Movie clips cannot be magnified.

## ■ ■ ■ Displaying Images in Sets of Nine (Index Replay)

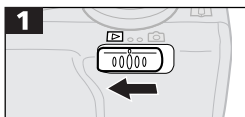

- The last recorded image will appear in the display (single image replay).



- A set of up to nine images will appear in the display (index replay).



Selected  
Image

Movie



- You can change the image selection with the ◀ or ▶ button. Pressing Q on the zoom lever displays the selected image in single image replay mode.

- You can use a shortcut to erase the selected image by holding the SET button and pressing the ◀ button (p. 52).





## Switching between Sets of Nine Images



- Successive sets of nine images can be shown in the display.



- Press the  button to display the previous set of nine images. The  button displays the next set of nine.
- Pressing Q on the zoom lever restores the index replay mode.

## Replaying Movies

Movie clips can be replayed with the following procedures.

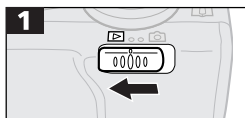

- Use the or button to select a movie.

• Movies cannot be played in the index replay mode.



- The movie images will play.
- Pressing the or button during replay stops it and displays the previous or next image.
- When the movie finishes, the last frame shows in the display.

## Pausing/Resuming



- Pressing the **SET** button pauses the replay. Pressing the **SET** button again resumes it.

- Frames may be dropped or the audio may break up if there are insufficient memory resources when movies are replayed on a computer.
- Movies can also be replayed on a TV. Both audio and visual recordings can be replayed when connected to a TV (p. 84).
- You can use a shortcut to erase the displayed movie by holding the **SET** button and pressing the button (p. 52).

- Movies and other clips shot with other cameras may not replay on this camera (List of Messages, p. 95).

## Rotating Images in the Display

Images can be rotated 90° or 270° clockwise in the display.



0° (Original)



90°



270°



- Use the ◀ or ▶ button to select .
- Cycle between the 90°/270°/0° orientation each time you press the **SET** button.
- Press the **MENU** button several times until the replay screen reappears.

- If an image has been rotated in the camera before being loaded onto a computer, the particular software in use will determine whether or not the rotation settings are retained.

- Movie clips cannot be rotated.
- Zooming rotated images reverses the rotation and displays the original orientation.

## Automating Playback (Auto Play)

All of the images on a CF card can be displayed one-by-one automatically with the auto play function. Each image is displayed for approximately 3 seconds.



- Use the ◀ or ▶ button to select .
- The camera will read the images on the CF card and start auto play.

- As with the single image display mode, pressing the ◀ or ▶ button during auto play will advance through the images more rapidly (p. 52).
- The display interval may vary for some images.
- Movies play for the entire recorded interval.

## Pausing and Resuming Auto Play



- Pressing the **SET** button temporarily pauses auto play. Press the **SET** button again to resume auto play.
- If the ◀ or ▶ button is pressed while auto play is paused, the display can be switched to the previous or next image, respectively. Hold down the ◀ or ▶ button to advance through the images more rapidly.

## Stopping Auto Play



- Stop the auto play by pressing the **MENU** button several times until the LCD monitor returns to the standard replay mode.

## Protecting Images

You can protect important images to prevent their accidental erasure.



- Use the ◀ or ▶ button to select 0000.

- Use the ◀ or ▶ button to select an image. Press the **SET** button to protect it.
- Pressing the **SET** button protects the image. If the **SET** button is pressed a second time, the protection is removed.



Protected  
Icon



- Press the **MENU** button several times until the replay screen reappears.

- Please note that even protected images are erased when a CF card is reformatted.

# Erasing Images

## Erasing Images Singly



- Please note that erased images cannot be recovered. Exercise adequate caution before erasing a file.
- Protected images cannot be erased with this function.

- Use the or button to select .

- Use the or button to select the image you wish to erase.





- Use the or button to select [OK].
- To cancel instead of erasing, select [Cancel].

- Images can also be erased using a shortcut (p. 52). However, images cannot be erased while Card Photo Printer CP-10 (sold separately) is connected.

## Erasing All Images



- Please note that erased images cannot be recovered. Exercise adequate caution before erasing a file.
- Protected images cannot be erased with this function.

- Use the  or  button to select .
- Use the  or  button to select [OK].
- To cancel the command, select [Cancel].



## Print Settings (DPOF Settings)

Images on a CF card can be individually selected for printing in a specified number of copies. The print type and date or file number printing options can also be selected. These settings are compatible with Digital Print Order Format (DPOF) standards so that images can be printed conveniently on DPOF compliant digital printers or at participating photo labs.

- After you set the DPOF settings, you can connect Card Photo Printer CP-10 (sold separately) and print images directly from the camera (p. 69). Please note that images with the print type set to [Index] cannot be printed on Card Photo Printer CP-10.

### Displaying the Print Settings Menu

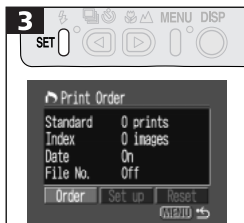
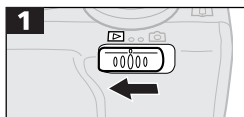







- Use the or button to select .
- Adjust the settings in the Print Settings menu in the following order.
  - 1 Set the Print Style (p. 64).
  - 2 Select Images for Printing (p. 65)
- Select Reset if you wish to reset all settings (p. 68).

- Print settings cannot be set for movies.
- The  mark will display on images that have had print marks set by another DPOF-compliant camera. These settings will be overwritten by any settings set by your camera.
- The output of some printers or developing labs may not reflect the specified print settings.

## Setting the Print Style

The following settings can be selected.

	 Standard	Prints one image per page.
 Print Type	 Index	Prints selected images at reduced size on a single sheet in an index format.
	 Both	Prints the images in both standard and index formats.
 Date		Adds the date to the print.
 File No.		Adds the file number to the print.

1

Display the Print Order menu (→ p. 63).



- Use the  or  button to select [Set up].

2



Print Order

- Use the  or  button to select ,  or .

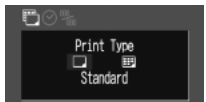

### (Print Type)

You may select [Standard], [Index] or [Both] options.

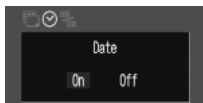

### (Date)

You may select either [On] or [Off].

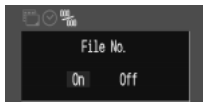

### (File No.)

You may select either [On] or [Off].



- Use the or button to select a setting. Press the **SET** button.
- Press the **MENU** button several times until the replay screen reappears.

- The date is printed in the format selected in the date format field of the Set Date/Time menu (p. 22).

- The date and file number options cannot both be set to On when [Index] is selected as the print type.

## Selecting Images for Printing

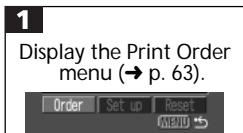

1 Display the Print Order menu (→ p. 63).

- Use the or button to select [Order].



The selection method will vary according to the print type (🖨️) (p. 64).

### Standard/Both



- Use the ◀ or ▶ button to select an image.
- The zoom lever can be used to switch between the single and index replay (3 images) modes for image selection.



- Pressing the **SET** button displays the ◀ ▶ icon so that the number of print copies can be specified. Pressing the **SET** button a second time causes the ◀ ▶ icon to disappear and restores the image selection mode.
- Use the ◀ or ▶ button to select the number of copies. The maximum is 99 copies.
- Press the **MENU** button several times



until the replay screen reappears.

## Index



- Use the ◀ or ▶ button to select an image.



- Pressing the **SET** button causes a check mark icon to appear. Pressing the **SET** button a second time deselects the image.



- Press the **MENU** button several times until the replay screen reappears.

- Images are printed in the order of the oldest image to the newest.
- When the print type is set to [Both] and both the date and file number are set to [On], only the file number will print on the index sheet.

## Resetting Print Settings

Resetting the print settings removes them from all the selected images and resets the print type to [Standard], the date setting to [Off] and the file number setting to [Off].

**1**

Display the Print Order menu (→ p. 63)



- Use the ◀ or ▶ button to select [Reset].

**2**

SET

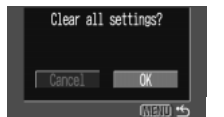

- Use the ◀ or ▶ button to select [OK].
- To cancel instead of resetting, select [Cancel].

**3**

SET



# Printing with Card Photo Printer CP-10

The optional Card Photo Printer CP-10 can be used to print images directly and effortlessly from the camera. It can also print images marked with DPOF print settings.

## Connecting Card Photo Printer CP-10

- Two direct interface cables are shipped with Card Photo Printer CP-10. Use the one with the ► symbol on its connectors.
- You are recommended to use a household power source (AC adapter sold separately) to power the camera when connecting it to a printer. When using a battery, ensure that it is fully charged. Monitor the battery charge closely when printing.

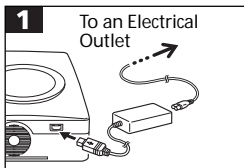



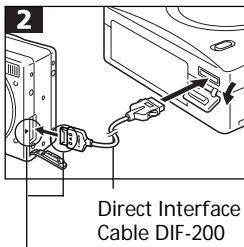

- Plug the power cable into the printer and then into an electrical outlet.



- Connect the direct interface cable to the printer.
- Open the terminal cover on the camera and attach the direct interface cable to the Digital A/V Out terminal.

- When detaching the cable, from the camera's Digital A/V Out Terminal, always press the **PUSH** button on the connector.

Attach the cable so that the ► symbols on the camera and cable meet.

- After you connect the printer, slide the mode switch to  and turn on the camera. If you switch from  mode to  mode when the camera power is already on, the lens will retract immediately.
- Please refer to the Card Photo Printer CP-10 manual for instructions on feeding paper or installing the ink cassette.
- All of the replay functions are available when the printer is connected, except for the following: replaying a movie, erasing images using the SET button and  button shortcut, and setting a language using the SET and MENU buttons.
- The  (direct printer) icon will disappear from the upper left of the LCD monitor and the normal replay mode will be restored when the connection with the printer is canceled.

## Printing

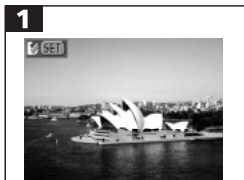

### Printing the Displayed Image

A single copy of an image can be printed while it is displayed in single image replay or index replay.



- The  icon will display when the printer is connected correctly.
- Select an image for printing.



- Use the  or  button to select [OK].
- Select [Style] if you wish to change the print style (p. 75).
- Select [Cancel] if you wish to stop printing.





- Press the **SET** button to start printing.
- The LCD monitor returns to the replay mode when the print concludes successfully.

- Printing cannot be stopped in mid process.
- Movie clips cannot be printed.

## Printing Errors

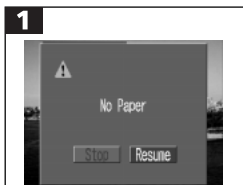

- Use the ◀ or ▶ button to select [Stop] or [Resume].

- The [Resume] option does not display with some types of error. In that case, select [Stop].



- Printing will stop or resume.

## Printing with DPOF Print Settings

Card Photo Printer CP-10 can print images marked with DPOF print settings, excluding those with the print type set to [Index].

1

Display the Print Order menu (→ p. 63)



- Use the ◀ or ▶ button to select [Print].

2

SET



DPOF Print Setting



Current Print Style

- Use the ◀ or ▶ button to select [OK].
- Select [Style] if you wish to change the print style (p. 75).
- Select [Cancel] if you wish to stop printing.
- Printing will start.

3

SET



4



- The LCD monitor returns to the replay mode when the print concludes successfully.

## Stopping Printing



- If the **SET** button is pressed while printing is underway, a confirmation message will appear.



- Use the **◀** or **▶** button to select [OK].
- Pressing the **SET** button stops the print queue after the image currently printing is finished. The LCD monitor returns to the replay mode.

## Resuming Printing

If printing is stopped with images left in the print queue, the remaining images can be printed with the following procedures.

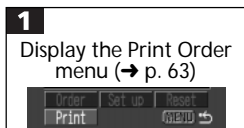

- Use the **◀** or **▶** button to select [Print].

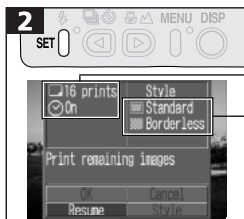

Number of Images Left to Print

Current Print Style

- Use the **◀** or **▶** button to select [Resume].
- Select [Style] if you wish to change the print style (p. 75).
- Select [Cancel] if you wish to stop printing.



- Press the **SET** button to resume printing.
- The LCD monitor returns to the replay mode when printing concludes successfully.

Printing cannot be resumed, however, under the following circumstances.

- When print setting are changed before printing is resumed.
- When images marked for printing are deleted before printing is resumed.
- When there is limited free capacity on the CF card when printing is stopped.

Printing resumes from the first image if [OK] is selected in the Print menu. You are recommended to use a household power source (AC adapter sold separately) if the battery pack charge is depleted and the camera shuts down. If you intend to use a battery pack, ensure that you charge it fully before use. Then turn the camera on again.

## Printing Errors

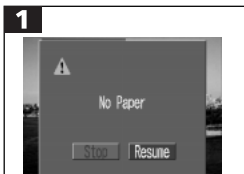

- Use the **◀** or **▶** button to select [Stop] or [Resume].







- The [Resume] option does not display with some types of error. In that case, select [Stop].



- Printing will stop or resume.



## Setting the Print Style

The following settings can be selected.

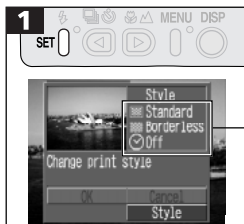
	 Standard	Prints one copy of one image per sheet.
 Image	 Multiple	Prints 8 copies of one image on a single sheet. Use the Multiple setting to print on adhesive labels.
 Borders	 Borderless	Prints the image to the edges of the sheet.
	 Bordered	Prints the image with borders.
 Date		Prints the date with the image.



Current Print Style

- Use the  or  button to select [Style].
- Select [Cancel] if you wish to cancel the setting.



- Use the  or  button to select ,  or .



 **Image**

Select [Standard] or [Multiple].



 **Borders**



Select [Borderless] or [Bordered].



### Date

Select [On] or [Off].





- Use the  or  button to select the desired option and press the **SET** button.
- Press the **MENU** button to complete the procedure.



- The date and border settings cannot be selected for images set to [Multiple] in the [Image] menu (they will print without dates or borders).
- The date cannot be selected for images marked with DPOF print settings. The date is printed according to the DPOF settings (p. 63).
- Printing with the [Bordered] setting prints virtually all of the image shown in the LCD monitor.
- Printing with the [Borderless] setting or the [Multiple] setting will result in the image being slightly cropped on all four sides because the aspect ratio of the image and paper is different.

# Camera Settings

## Displaying the Rec. Menu

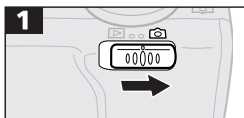
Camera settings are adjusted with the Rec. menu according to the following procedures. For instructions on changing the resolution  and compression , please see page 37. Please see page 34 to learn how to change the review time  for images.



- The Rec. menu can be displayed in  mode. It can not be shown in  mode.

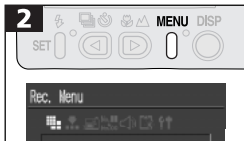

- Press the **MENU** button repeatedly until the Rec. menu appears (p. 30).



- Complete the procedure.

## Resetting the File Number

You can select the method which the camera uses to assign file numbers with the File No. Reset function.

<b>On</b>	The starting file number is reset to 100-0001 each time a new CF card is inserted. New images recorded on previously recorded CF cards with existing files are assigned the next available number.
<b>Off</b>	The file number of the last recorded image is saved so that the next image recorded on any CF card, including a new one, is assigned the next available number.

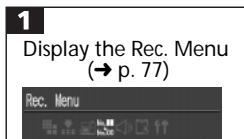

- Use the or button to select .

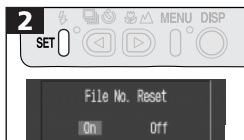

- Use the or button to select [On] or [Off].



- Shooting with the File No. Reset set to [Off] is useful for avoiding file name duplication when the images are uploaded to a computer and organized in a single directory or album.

### About File Numbers

- Images are assigned individual frame numbers ranging from 0001 to 9900 and organized in folders containing up to 100 images. The folders are assigned names from 100 to 998. (Folder numbers cannot contain 99 in the last two digits.)
- Since images shot in , or mode are always saved together in the same folder, some folders may contain 101 or more images.



## Setting the Beep On/Off

A beep sounds for confirmation purposes when the shutter button is pressed or a camera setting is changed. The beep can be turned off.

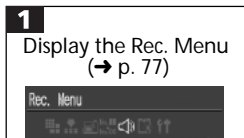

- Use the or button to select .



- Use the or button to select [On] or [Off].



- The warning beep is not controlled by this setting and will still sound.

## Formatting CF Cards

New CF cards must be formatted in accordance with the following procedures before use.

- Please note that formatting a CF card erases all its data, including protected images and other types of data.

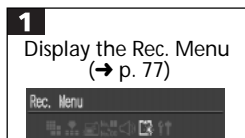

- Use the or button to select .



- Use the or button to select [OK].
- To cancel formatting, select [Cancel].



- When the camera is not operating as expected, reformatting the CF card may solve the problem.
- When a non-Canon brand CF card is malfunctioning, reformatting it may solve the problem.
- CF cards formatted in other cameras, or by computers or peripheral devices, may not operate correctly in the camera. Reformat the card in your camera.

## Changing Other Settings

### Switching the Auto Power Down Function On/Off

The auto power down function can be set to automatically turn the camera power off after a set period of time passes without the camera being used.

<b>On</b>	The camera shuts off after approximately 3 minutes in shooting mode or approximately 5 minutes in replay mode if the camera is not used. Press the main switch to restore power.
<b>Off</b>	If it is on, the LCD monitor shuts off after approximately 3 minutes in the shooting mode if the camera is not used. Pressing any button other than the main switch will turn the LCD monitor on again.

**1**

Display the Rec.Menu  
(→ p. 77)



- Use the ◀ or ▶ button to select .

**2**

SET MENU DISP

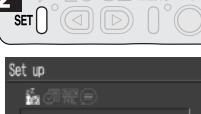

- Use the ◀ or ▶ button to select .

**3**

SET MENU DISP



- Use the ◀ or ▶ button to select [On] or [Off].

**4**

SET MENU DISP



- The auto power down function will not activate in auto play even when it is set to On.

## Setting the Video Signal Format

To use a TV monitor to shoot or replay images, the video signal format can be switched to suit regional standards.

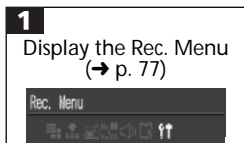

- Use the or button to select



- Use the or button to select



- Use the or button to select [NTSC] or [PAL].



## Setting the Language

The language in which menus and messages are displayed can be selected with this function.

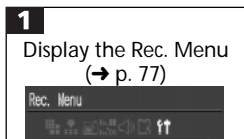

- Use the or button to select .

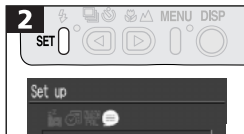

- Use the or button to select .



- Use the or button to select a language.





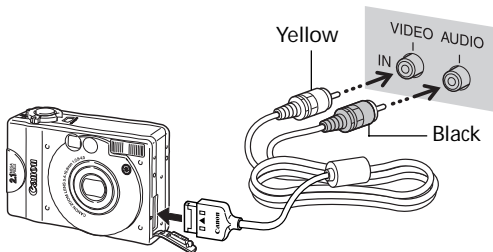

- The Language menu can also be displayed in replay mode by holding down the **SET** button and pressing the **MENU** button. However, language settings cannot be adjusted while Card Photo Printer CP-10 (sold separately) is connected.
- The Language menu may appear differently on cameras in some regions.

## Shooting/Replaying with a TV Monitor

A TV monitor can be used to view images as they are shot or replayed when it is connected to the camera via the supplied AV cable (AVC-DC200). Always turn the camera and TV power off before attaching or detaching the AV cable.



- After the cable has been attached, turn on the TV and switch it to the Video mode.
- Turn on the camera and slide its mode switch to  or .
- If the image does not appear on the TV when shooting, press the **DISP** button.

- TV monitors cannot be used with the  and  mode.
- Images will not appear in the camera's LCD monitor when the TV is used as the monitor.
- The video output signal can be switched (NTSC or PAL) to accommodate different regional standards (p. 82). The default setting will vary between regions.
  - NTSC: Japan, U.S.A., Canada, Taiwan, etc
  - PAL: Europe, Asia (excluding Taiwan), Oceania, etc.
- Connect the AV cable to either the left or right Audio In jack on the TV. Please check your TV's manual for the correct configuration.

# Downloading Images to a Computer

## Downloading Directly from a CF Card

Images can be loaded directly from a CF card to a computer if you are using a notebook computer, a PC card reader or a CF card reader.

### Inserting the CF Card

#### PC Card Reader

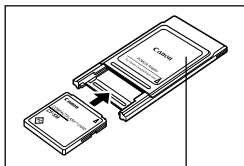

PC Card Adapter

- A PC card adapter (PCMCIA adapter), sold separately, is required to use a PC card reader.

1. Eject the CF card from the camera and insert it into the PC card adapter.
2. Insert the PC card adapter into the computer's PC card slot or PC card reader.

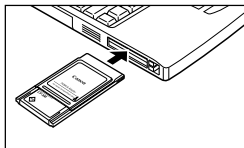

- Some computers or PC card readers require the power to be off when the PC card adapter is inserted into the PC card slot. Since this requirement varies between models, please consult the manual for your equipment.

#### CF Card Reader

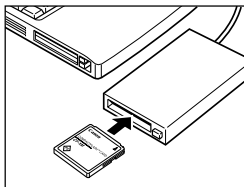

1. Eject the CF card from the camera and insert it directly into a CF card reader connected to the computer.

- Some computers or CF card readers require the power to be off when the CF card is inserted. Since this requirement varies between models, please consult the manual for your equipment.

## Downloading Images

- 1 Double-click the icon of the drive with the CF card.
- 2 Copy the photographed images to the desired folder on the hard disk.

The images are contained in the [XXXCANON] folder inside the [DCIM] folder on the CF card. The XXX represents a number from 100 to 998.

### Image Folder Organization and File Names

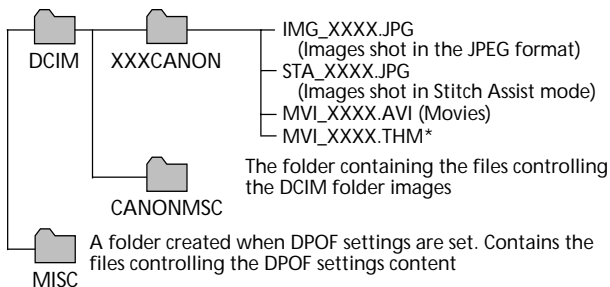

- \*These files contain thumbnail images for the index display.
- A number will appear in place of each "X" in the file names.
- Do not open or delete files in folders other than [XXXCANON]. Those files are required for image management.

### Viewing Downloaded Movies on a Windows System

If you try to view a movie by double-clicking its file name (AVI extension) in Windows Explorer, Windows Media Player may start without being able to replay it. To replay a movie, start the bundled software program that supports movies and open the movie file from within it.

Please refer to the *Software Starter Guide* for the remaining procedures.



# Connecting the Camera to a Computer with a USB Cable

## Supported Operating Systems

Windows	Windows 98 (Including the Second Edition) Windows Millennium Edition (Windows Me) Windows 2000 *Only systems pre-installed with Windows 98/Me/2000 or upgraded to Windows Me from pre-installed Windows 98 systems are supported.
Macintosh Computers	Mac OS 8.1 or later, QuickTime 3.0 or later (not supported on Mac OS X) *Only genuine Apple Computer systems with built-in USB interfaces are supported.

- Before connecting the camera to your computer for the first time, you must install the required software onto the computer. Once the software has been installed, you can connect the camera to the computer using USB Interface Cable IFC-200PCU, which is included.
- Please see the *Software Starter Guide* to learn how to install the software and download images.
- Please use a CF card reader or PC card reader to download images to a system running Windows 95 or Windows NT.
- Please power the camera with an AC adapter (sold separately) connected to a household power source.

## Connection Precautions

- The USB ports may not operate correctly on systems that have been upgraded to Windows 98/Me/2000 from Windows 3.1/95 or to Windows 2000 from a pre-installed Windows 98 system.
- With Macintosh computers, the USB interface only works with Power Macintosh NEW G3/G4, PowerBook G3, iMac and iBook models with built-in USB connectors.
- Connect the camera directly to a USB port on the computer. The interface may not operate correctly when connected through a USB hub.

- Operating the camera simultaneously with other USB devices, excluding USB mice and keyboards, may not work correctly. If this occurs, disconnect the other devices and then reconnect the camera.
  - Do not have more than two cameras connected to a computer with the USB interface at any time. The cameras may not operate correctly.
- Do not put the computer into standby (sleep) mode when a camera is connected via a USB port. If the computer should go into standby mode while a camera is connected to a USB port, leave the camera connected (never disconnect it) and try to take the computer out of standby mode. Some computers may not recover properly from the standby mode if the cable is disconnected. Please refer to the computer's manual for information regarding the standby mode.

## Connecting to a USB Port

- 1** Connect the supplied USB interface cable to the computer's USB port and the camera's Digital A/V Out terminal.

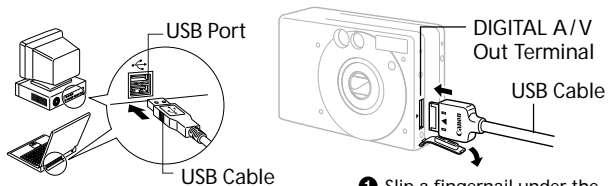

- 1** Slip a fingernail under the upper edge of the terminal cover to open it.
- 2** Insert the cable so that the ► symbols on the cable and camera align.

- You do not need to turn the camera or computer power off to connect or disconnect USB interface cables.
- Please refer to your computer's manual for information regarding the location of the USB ports.

## 2 Slide the camera's mode switch to .

- The replay screen will display and when the connection to the computer is complete, the LCD monitor will shut off and the indicator will glow green.

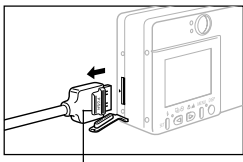

**PUSH** Button

- Always press the **PUSH** button on the connector when detaching the cable from the camera's Digital A/V Out terminal.

- If the USB cable is detached while the camera power is on, the camera will power down.
- When the camera is connected to a computer, a warning displays on the computer display after 5 minutes if the camera is not used. The camera shuts down if a further minute passes without a button being pressed. To restore power, press the main switch again.
- Please refer to the *Software Starter Guide* for the subsequent procedures.

## Appendices

### Care and Maintenance of the Camera

Use the following procedures to clean the camera body, lens, viewfinder and LCD monitor.

- Never use thinners, benzene, synthetic cleansers or water to clean the camera. These substances may distort or damage the equipment.

#### Camera Body

Gently wipe dirt off the camera body with a soft cloth or eyeglass lens wiper.

#### Lens

First use a lens blower brush to remove dust and dirt, then remove any remaining dirt by wiping the lens lightly with a soft cloth.

- Never use synthetic cleansers on the camera body or lens.
- If dirt remains, contact the closest Canon Customer Support Help Desk (see the back of this guide).

#### Viewfinder and LCD Monitor

Use a lens blower brush to remove dust and dirt. If necessary, gently wipe the viewfinder with a soft cloth or an eyeglass lens wiper to remove stubborn dirt.



- Never rub or press strongly on the LCD monitor. These actions may damage it or lead to other problems.

## Troubleshooting

### 🔍 Camera will not operate

Cause	Solution
Power is not on	<ul style="list-style-type: none"> <li>• Press the main switch for a few moments.</li> </ul>
Battery cover or CF card cover opened	<ul style="list-style-type: none"> <li>• Close the battery cover or CF card cover and then press the main switch again to turn the camera off.</li> </ul>
Insufficient battery voltage	<ul style="list-style-type: none"> <li>• Insert a fully charged battery pack.</li> <li>• Use a household power source.</li> </ul>
Poor contact between battery pack and camera terminals	<ul style="list-style-type: none"> <li>• Wipe the battery terminals with a clean, dry cloth.</li> </ul>

### 🔍 Camera will not record

Cause	Solution
Mode switch is set to  (Replay)	<ul style="list-style-type: none"> <li>• Slide the mode switch to  (shooting).</li> </ul>
Flash is charging	<ul style="list-style-type: none"> <li>• Wait until the flash charges. You can press the shutter button when the indicator glows a steady orange.</li> </ul>
CF card full	<ul style="list-style-type: none"> <li>• Replace the CF card.</li> <li>• If necessary, download the images to a computer and then erase all or some of the card's images to create space.</li> </ul>
CF card not formatted correctly	<ul style="list-style-type: none"> <li>• Format CF card. See Formatting a CF Card (p. 80).</li> <li>• If reformatting does not work, the CF card logic circuits may be faulty or damaged. Contact the nearest Canon Customer Support Help Desk.</li> </ul>

### Lens will not retract

Cause	Solution
Battery cover or CF card cover was opened with power on	<ul style="list-style-type: none"> <li>• First close the battery cover or CF card cover and then turn the power off.</li> </ul>
Battery cover or CF card cover was opened while recording to the CF card (warning signal sounds)	<ul style="list-style-type: none"> <li>• First close the battery cover or CF card cover and then turn the power off.</li> </ul>

### Battery pack consumed quickly

Cause	Solution
At room temperature (23 °C or 73 °F), fast discharge indicates the battery pack's service life is over	<ul style="list-style-type: none"> <li>• Replace the battery pack with a fresh one.</li> </ul>

### Battery pack will not charge

Cause	Solution
Battery pack life exceeded	<ul style="list-style-type: none"> <li>• Replace battery pack with a new one.</li> </ul>
Poor connection between battery pack and battery charger	<ul style="list-style-type: none"> <li>• Seat the battery pack more firmly in the charger.</li> <li>• Plug the battery charger all the way into the electrical outlet.</li> </ul>

## 🔍 Image is blurred, out of focus, or not as expected

Cause	Solution
Camera moved	<ul style="list-style-type: none"> <li>• Be careful not to move the camera when pressing the shutter button.</li> </ul>
Autofocus function is hampered by something obstructing the AF auxiliary light emitter	<ul style="list-style-type: none"> <li>• Be careful not to block the AF auxiliary light emitter with your fingers or other items.</li> </ul>
Subject is out of focal range	<ul style="list-style-type: none"> <li>• Ensure that there is at least 57 cm (1.9 ft.) between the camera lens and subject.</li> <li>• Use the macro mode to shoot close-ups between 10 and 57 cm (3.9 in. and 1.9 ft.) from the lens when set to wide angle and between 27 and 57 cm (10.6 in. and 1.9 ft.) when set to telephoto.</li> <li>• Use the infinity mode to shoot distant subjects.</li> </ul>

## 🔍 Subject is too dark in image

Cause	Solution
Insufficient light for shooting	<ul style="list-style-type: none"> <li>• Set the flash to On.</li> </ul>
Subject is much darker than its surroundings	<ul style="list-style-type: none"> <li>• Set the exposure compensation to a positive (+) setting.</li> </ul>
Subject is too far away for flash to reach	<ul style="list-style-type: none"> <li>• When using the flash, ensure that the camera is no farther from the subject than 3 m (9.8 ft.) at the maximum wide angle, or 2 m (6.6 ft.) at the maximum telephoto setting.</li> </ul>

**❓ Subject is too bright**

Cause	Solution
Subject is too close and the illumination from the flash is too bright.	<ul style="list-style-type: none"> <li>When using the flash, ensure that the camera is no closer to the subject than 27 cm (10.6 in.).</li> </ul>
Subject is much brighter than its surroundings	<ul style="list-style-type: none"> <li>Adjust the exposure compensation to a negative (-) setting.</li> </ul>
Light is shining directly on subject or reflected off subject onto camera	<ul style="list-style-type: none"> <li>Change the shooting angle.</li> </ul>
Flash is set to On	<ul style="list-style-type: none"> <li>Set the flash to any setting other than On.</li> </ul>

**❓ Flash will not fire**

Cause	Solution
Flash is set to Off	<ul style="list-style-type: none"> <li>Set the flash to any setting other than Off.</li> </ul>

**❓ Zoom does not work**

Cause	Solution
Zoom lever pressed during movie recording	<ul style="list-style-type: none"> <li>Adjust the zoom before shooting a movie.</li> </ul>



## List of Messages

The following messages may appear in the LCD monitor.

Busy...:	Image is being recorded to, or read from, CF card
No CF card:	You attempted to shoot or replay images without a CF card installed.
Cannot record!:	You attempted to shoot an image without a CF card installed.
CF card error:	CF card has experienced an anomaly.
CF card full:	CF card is too full to accommodate more images or print settings.
Naming error!:	The file could not be created because there is a file with the same name as the directory that the camera is attempting to create, or the highest possible file number has already been reached. In the Rec. Menu, set the [File No. Reset] option to [On]. Save all the images you wish to retain onto a computer, then reformat the CF card. Please note that formatting will erase all the existing images and other data.
Change the battery pack:	Battery charge is insufficient to operate the camera. Replace it at once with a charged one or recharge the battery pack.
No image:	No images recorded on CF card.
Image too large:	You attempted to replay an image larger than 3200 x 2400 pixels or a movie clip recorded by another camera.

---

Incompatible JPEG format:	You attempted to replay an incompatible JPEG file.
Corrupted Data:	You attempted to replay an image with corrupted data.
RAW:	You attempted to replay a RAW image.
Unidentified Image:	You attempted to replay an image that was recorded in a special format (proprietary format used by the camera of another manufacturer, etc.) or a movie clip recorded by another camera.
Cannot magnify!:	You attempted to magnify an image which was photographed with another camera, recorded in a different format, or edited on a computer.
Cannot rotate:	You attempted to rotate an image which was photographed with another camera, recorded in a different format, or edited on a computer.
Protected!:	You attempted to erase a protected image.
Too many marks:	Too many images have been marked for printing. Cannot process any more.

---

---

Exx:	(xx: number) Camera malfunction. Turn the power off and then back on, then shoot or replay. Problem exists if error code reappears. Note the number and contact Canon Customer Support Help Desk. If an error code displays directly after taking a picture, the shot may not have been recorded. Check image in replay mode.
------	---

---

The following messages may appear on the camera's LCD monitor while a Card Photo Printer CP-10 (optional) is connected.

---

No Paper:	Paper cassette is empty or incorrectly installed. The paper may also be misfeeding.
No Ink:	The ink cassette is empty or removed.
Ink Cassette Error:	There is a problem with the ink cassette.
Paper Jam:	Paper jammed while printing.
Communication Error:	A communication error has occurred.
Cannot print!:	You attempted to print an image shot by a different camera, or in an incompatible format, or downloaded to and edited on a computer.
Could not print XX images:	You attempted to print XX number of images with DPOF settings that were shot by a different camera, or in an incompatible format, or downloaded to and edited on a computer.

---

# Specifications

## PowerShot S110 DIGITAL ELPH / DIGITAL IXUS v

Image Sensor:	Approx. 2.11 million-pixel 1/2.7 in. CCD (effective pixels: approx. 2.02 million)
Lens:	5.4 (W) - 10.8 (T) mm (35 mm film equivalent: 35 - 70 mm) F2.8 (W) - 4.0 (T)
Digital Zoom:	Maximum 2.5x (5.0x with optical zoom)
Optical Viewfinder:	Primary imaging real-image optical zoom viewfinder
LCD Monitor:	Approx. 120,000-pixel, 1.5 in. low-temperature polycrystalline silicon TFT LCD
Autofocus:	Through the lens (TTL), 3-point artificial intelligence autofocus (AiAF)
Focusing Range:	Normal Mode: 57 cm (1.9 ft.) - ∞ Macro Mode: 10-57 cm (3.9 in. - 1.9 ft.) (W) 27-57 cm (10.6 in. - 1.9 ft.) (T)
Shutter:	Mechanical + electronic
Shutter Speed:	1 - 1/1500 sec. 1 sec. in manual mode with the flash off or in slow synchro mode Noise reduction processing on speeds slower than 1/6 sec.
Light Metering Method:	Evaluative metering (linked to focusing point)
Exposure Control:	Program AE
Exposure Compensation:	± 2 EV (1/3 steps)
Sensitivity:	ISO 100 equivalent (automatically raised to ISO 150 equivalent in low light)
White Balance:	TTL auto/preset (daylight, cloudy, tungsten, fluorescent)
Flash:	Red-eye reduction auto/auto/on/off/slow-synchro
Flash Range:	Normal Mode: 57 cm - 3 m (1.9 - 9.8 ft.) (W) 57 cm - 2 m (1.9 - 6.6 ft.) (T) Macro Mode: 27-57 cm (10.6 in. - 1.9 ft.) (W/T)
Shooting Modes:	Auto/manual/stitch assist/movie
Continuous Shooting:	Approx. 2.5 images / sec. (Large / Fine mode, LCD monitor off)

(W) = wide angle, (T) = telephoto

Self-Timer:	Shoots after approx. 10 sec.
PC Connected Shooting:	Available (USB connection only. Exclusive software program "RemoteCapture" is included in the Camera Kit.)
Recording Media:	CompactFlash card (Type I)
File Format:	Design rule for Camera File system, DPOF compliant
Image Recording Format:	Stills: JPEG Movies: AVI (Images: Motion JPEG/ Audio: WAVE (monophonic))
Compression:	Superfine/fine/normal
Number of Recording Pixels:	Stills: large (1600 x 1200 pixels)/medium (1024 x 768 pixels)/small (640 x 480 pixels) Movies: 640 x 480 pixels (approx. 4 sec.)/320 x 240 pixels (approx. 10 sec.)/160 x 120 pixels (approx. 30 sec.) Approx. 20 frames/sec., Figures in brackets ( ) represent max. recording time for one movie clip.
Replay Modes:	Single image replay/index replay (9 thumbnails)/zoomed view (LCD monitor zooms images up to 2.5 times)/auto play/printing with Card Photo Printer CP-10 (print images directly)
Interface:	USB AV OUT (NTSC or PAL switchable, monophonic sound)
Power Source:	Battery Pack NB-1L (rechargeable lithium ion), Compact Power Adapter CA-PS500
Operating Temperatures:	0 - 40 °C (32 - 104 °F)
Operating Humidity:	10 - 90%
Dimensions (w x h x d):	87 x 57 x 26.9 mm (3.4 x 2.4 x 1.1 in.) (excluding lens projection)
Weight:	Approx. 190 g (6.7 oz.) (excluding batteries and CF Card)

## Accessories

### Battery Pack NB-1L

Type:	Rechargeable Lithium Ion Cell
Nominal Voltage:	3.7 V
Typical Capacity:	680 mAh
Cycle Life:	Approx. 300 times
Operating Temperatures:	0 - 40 °C (32 - 104 °F)
Dimensions:	32.3 x 49.8 x 10.6 mm (1.3 x 1.9 x 0.4 in.)
Weight:	Approx. 29 g (1.0 oz.)

### Battery Charger CB-2LS/CB-2LSE

Rated Input:	100 - 240 V AC (50/60 Hz) 0.075 A (100 V) - 0.045 A (240 V)
Rated Output:	4.2 V DC / 0.5 A
Charging Time:	Approx. 130 minutes
Operating Temperatures:	0 - 40 °C (32 - 104 °F)
Dimensions:	90.4 x 56.0 x 28.0 mm (3.6 x 2.2 x 1.1 in.)
Weight:	CB-2LS: Approx. 78 g (2.8 oz.) CB-2LSE: Approx. 75 g (2.6 oz.)

### CompactFlash™ Card

Card Slot Type:	Type I
Dimensions:	36.4 x 42.8 x 3.3 mm (1.4 x 1.7 x 0.1 in.)
Weight:	Approx. 10 g (0.4 oz.)

### Compact Power Adapter CA-PS500 (Optional)

Rated Input:	100 - 240 V AC (50/60 Hz) 0.17 A
Rated Output:	4.3 V DC / 1.5 A
Operating Temperatures:	0 - 40 °C (32 - 104 °F)
Dimensions:	42.6 x 104.4 x 31.4 mm (1.7 x 4.1 x 1.2 in.)
Weight:	Approx. 180 g (6.3 oz.)

\* All data is based on Canon's standard testing methods. Subject to change without notice.

# Index

## A

- AC Adapter Kit 19
- Autofocus 26
- Auto 36
- Auto Play 58
- Auto Power Down 24
  - On/Off 81
- AV Cable 84

## B

- Battery
  - AC Adapter 19
  - Handling 16
  - Household Power Source 19
  - Installing 17
  - Performance 18
  - Recharging 15
- Battery Pack 15
- Beep 79
- Black and White Mode 45

## C

- Camera Settings 77
- Card Photo Printer CP-10 69
- Care and Maintenance 90
- CF Card
  - Capacity 21
  - Formatting 80
  - Handling 21
  - Installing 20
- Compression 37
- Continuous Shooting 42

## D

- Date and Time 22
- Digital Zoom 35, 53
- Direct Interface Cable 69
- Displaying Information 28
- DPOF 63

## E

- Erasing 61
  - Erasing All Images 62

- Erasing Images Singly 61
- Erasing the Displayed Image 52
- Exposure 44

## F

- File Number 78
- Flash 39
- Focus Lock 26

## I

- Image Sizes 38
- Index Replay 54
- Indicator 14
- Infinity Mode 41
- Information Display 28

## L

- Language Settings 83
- LCD Monitor 13
  - Menus/Switching between Display Modes 30
  - Using 27

## M

- Macro Mode 41
- Main Switch 14, 24
- Magnifying Images 53
- Manual 36
- Mode Switch 36
- Movie 49, 56

## O

- Optical Viewfinder 26

## P

- Power On/Off 24
- Pressing Fully 32
- Pressing Halfway 32
- Print Settings 63
  - Selecting 65
  - Print Style 64
  - Resetting Print Settings 68
- Protecting Images 60

**R**

Rec. Menu 77  
Red-Eye Reduction 40  
Replay 28, 52  
    TV Monitor 84  
Resolution 37  
Rotate 57

**S**

Self-Timer 43  
Shooting 28, 36  
    TV Monitor 84  
    Functions Available in each  
        Shooting Mode 51  
    List of Modes 36  
Shutter Button 14, 32  
    Pressing Fully 32  
    Pressing Halfway 32  
Single Image Replay 52  
Stitch Assist 46

**T**

Telephoto 35

**V**

Video Signal Format 82  
Viewfinder 26

**W**

White Balance 45  
Wide Angle 35  
Wrist Strap 23

**Z**

Zoom 35  
Zooming Images 53  
Zoom Lever 14, 35



### Disclaimer

- While every effort has been made to ensure that the information contained in this guide is accurate and complete, no liability can be accepted for any errors or omissions. Canon reserves the right to change the specifications of the hardware and software described herein at any time without prior notice.
- No part of this guide may be reproduced, transmitted, transcribed, stored in a retrieval system, or translated into any language in any form, by any means, without the prior written permission of Canon.
- Canon makes no warranties for damages resulting from corrupted or lost data due to a mistaken operation or malfunction of the camera, the software, the CompactFlash™ cards (CF cards), personal computers, peripheral devices, or use of non-Canon CF cards.

### Trademark Acknowledgments

- Canon is a trademark of Canon Inc.
- CompactFlash is a trademark of SanDisk Corporation.
- iBook and iMac are trademarks of Apple Computer, Inc.
- Macintosh, PowerBook and Power Macintosh are trademarks of Apple Computer, Inc., registered in the United States and other countries.
- Microsoft, Windows and Windows NT are either registered trademarks or trademarks of Microsoft Corporation in the United States and / or other countries.
- Other names and products not mentioned above may be registered trademarks or trademarks of their respective companies.

## Canon Customer Support

### Canon Inc.

30-2 Shimomaruko 3-chome, Ohta-ku, Tokyo  
146-8501, Japan

## NORTH AMERICA

### Canon U.S.A., Inc.

Canon Customer Care Center  
Phone (US): 1-800-828-4040  
(Available Mon. - Fri., 9 AM to 8 PM Eastern Time)

### Canon Canada Inc.

Phone (Canada): 1-800-OK-CANON (1-800-652-2666)  
(24 hours/day, 7 days/week)

## EUROPE

### *Europe, Africa & Middle East*

#### Canon Europa N.V.

PO Box 2262, 1180 EG Amstelveen, The Netherlands

#### Canon (UK) Ltd.

Helpdesk  
Tel.: 08705 143 723 (Calls may be recorded.) Fax.: 08705 143 340

#### Canon France S.A.

Hotline : 01.41.99.70.70  
Tél : 01.41.99.77.77 Télécopie : 01.41.99.79.51

#### Canon Photo Vidéo France S.A.

Support Client : 01.41.30.15.15  
Fax : 01.41.30.15. 05

#### Canon Deutschland GmbH

Canon-Hotline-Service:  
Customer Support: (02151) 349-555  
Info Desk: (02151) 349-566 Fax: (02151) 349-588

#### Canon Euro-Photo GmbH

Customer-Support: (02154) 495-482 or 483 Fax: (02154) 495-489

**Canon Italia S.p.A.**

Pronto Canon: 02 8249 2000

**Canon Belgium N.V. / S.A.**

Helpdesk: 0900-10627

Tel.: (02) 722.04.11 Fax: (02) 721.32.74

**Canon Luxembourg S.A.**

Tel.: (352) 48 47 961 Fax: (352) 48 47 96232

**Canon Nederland N.V.**

Helpdesk: 023 - 5 681 681

Tel.: 023 - 5 670 123 Fax: 023 - 5 670 124

**Canon Danmark A/S**

Phone: +45 44882400 e-mail: helpdesk@canon.dk

**Canon España S.A.**

Help Desk: 906 301 255

Fax: (91) 411 76 65 E-mail: helpdesk1@btlink.net

**Canon Norge as**

Tlf. 22 62 93 21 Faks: 22 62 06 15

E-mail: helpdesk@canon.no

**Finland****Canon OY**

Puhelin: 010 54420 Fax: 010 544 4571

Help Desk: 0600 0 22606 (14,80 mk/min+pvm)

Help Desk: 0600 0 22666 (enint. 40mk/puhelu+pvm)

Sähköposti: helpdesk@canon.fi

**Canon (Schweiz) AG**

Tel. 01-835-6161 Fax 01-835-6526 Hotline 0900 57 55 20

**Canon Svenska AB**

Tel.: 08-744 85 00 Fax: 08-744 64 65

**Austria****Canon GmbH**

Oberlaaerstraße 233 A-1100 Vienna

Tel: 01 680 88-0 Fax: 01 680 88-308

## OCEANIA

**Canon Australia Pty. Ltd.**

Info-Line: (02) 9805 2864

**Canon New Zealand Ltd.**

Info-Line: 0900-522666

## ASIA

**Canon Singapore Pte. Ltd.**

79 Anson Road, #09-01 / 06, Singapore 079906

Phone: (65) 532 4400 Fax: (65) 221 7577

**Canon Hongkong Co., Ltd.**

9/F, The Hong Kong Club Building, 3A Chater Road, Central, Hong Kong

Phone: 852-2739-0802 Fax: 852-2369-7701

**Canon Marketing Services**No.1 Jalan Kilang Timor, #09-00, Pacific Tech Centre,  
Singapore 159303

Phone: (65) 799 8888 Fax: (65) 273 3317

**Canon Marketing (Malaysia) Sdn. Bhd.**Wisma General Lumber, Block D, Peremba Square,  
Saujana Resort, Section U2, 40150,

Shah Alam, Selangor Darul Ehsan, Malaysia

Phone: (60) 3 744 6000, (60) 3 745 0055

Fax: (60) 3 745 0505

**Canon Marketing (Thailand) Co., Ltd.**

10th Floor, Bangkok City Tower,

179/34-45 South Sathorn Road,

Bangkok 10120, Thailand

Phone: (662) 344 9999 Fax: (662) 344 9910

**Canon Marketing (Hongkong) Co., Ltd.**10/F, Mirror Tower, 61 Mody Road, Tsimshatsui East  
Kowloon HongKong

Phone: 852-2170-2828 Fax: 852-2723-9684

## FCC Notice

(Digital Camera, Model PC1012)

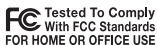

This device complies with Part 15 of the FCC Rules. Operation is subject to the following two conditions:

- (1) this device may not cause harmful interference, and
- (2) this device must accept any interference received, including interference that may cause undesired operation.

Note: This equipment has been tested and found to comply with the limits for Class B digital devices, pursuant to Part 15 of the FCC rules. These limits are designed to provide reasonable protection against harmful interference in a residential installation. This equipment generates, uses and can radiate radio frequency energy and, if not installed and used in accordance with the instructions, may cause harmful interference to radio communications. However, there is no guarantee that interference will not occur in a particular installation. If this equipment does cause harmful interference to radio or television reception, which can be determined by turning the equipment off and on, the user is encouraged to try to correct the interference by one or more of the following measures:

- Reorient or relocate the receiving antenna.
- Increase the separation between the equipment and receiver.
- Connect the equipment into an outlet on a circuit different from that to which the receiver is connected.
- Consult the dealer or an experienced radio/TV technician for help.

The cables with the ferrite core provided with the digital camera must be used with this equipment in order to comply with Class B limits in Subpart B of Part 15 of the FCC rules.

Do not make any changes or modifications to the equipment unless otherwise specified in the manual. If such changes or modifications should be made, you could be required to stop operation of the equipment.

Canon U.S.A. Inc.

One Canon Plaza, Lake Success, NY 11042, U.S.A.

Tel No. (516) 328-5600

## Canadian Radio Interference Regulations

THIS CLASS B DIGITAL APPARATUS MEETS ALL REQUIREMENTS OF THE CANADIAN INTERFERENCE CAUSING EQUIPMENT REGULATIONS.

## Réglementation canadienne sur les interférences radio

CET APPAREIL NUMERIQUE DE LA CLASSE B RESPECTE TOUTES LES EXIGENCES DU REGLEMENT SUR LE MATERIEL BROUILLEUR DU CANADA.

**Canon**