

OLYMPUS[®]

DIGITAL CAMERA

FE-200

Basic Manual

ENGLISH 2

FRANÇAIS 28

ESPAÑOL 54

PORTUGUÊS 80

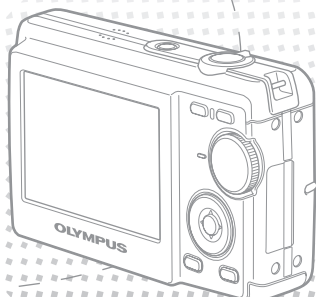
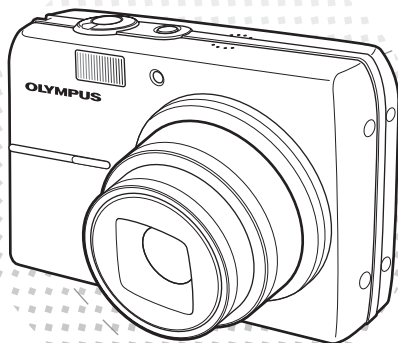

Table of Contents

Gather these items (box contents)	3
Insert the batteries	4
Turn on the power	5
Set date and time	6
Select a Language	8
Shoot	9
View pictures	10
Basic Operation	11
Shooting Mode Buttons	11
Mode Dial	12
SCENE Modes	12
Macro Mode	13
Flash Modes	13
Self-Timer	14
Power Save Feature	14
Menus and Settings	15
Top Menu	15
Erase All Pictures	15
Connecting the Camera	16
Playback on a TV	16
Direct Printing (PictBridge)	17
Transfer Images	18
OLYMPUS Master Software	20
Specifications	21
Safety Precautions	23
● Before using your camera, read this manual carefully to ensure correct use.	
● We recommend that you take test shots to get accustomed to your camera before taking important photographs.	
● Please observe the safety precautions at the end of this manual.	
● The images of the LCD screen and illustrations of the camera used in this manual may differ from the actual product.	

Gather these items (box contents)



Digital camera



Strap



LI-12B
Lithium ion battery

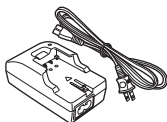

LI-10C
Battery charger



USB cable

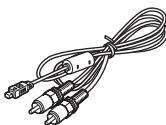

AV cable



OLYMPUS Master
CD-ROM

En

Other items

- Basic manual (this manual)
 - Advanced manual
 - Warranty card
- Contents may vary depending on purchase location.

Attach the strap

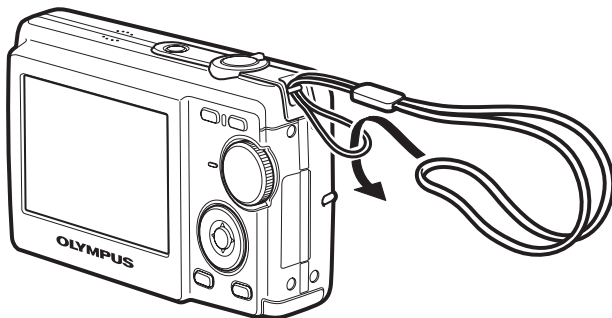

- Pull the strap tight so that it does not come loose.

Insert the batteries

a. Charge the battery

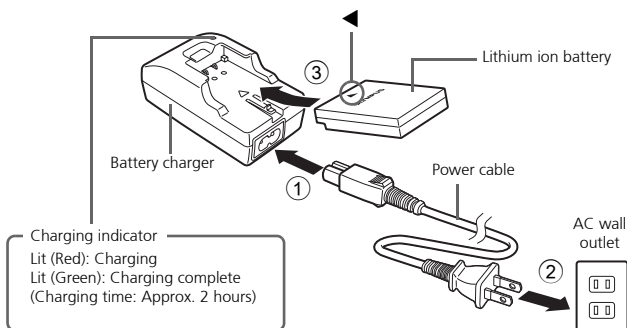

- Battery comes partially charged.

b. Insert the battery into the camera

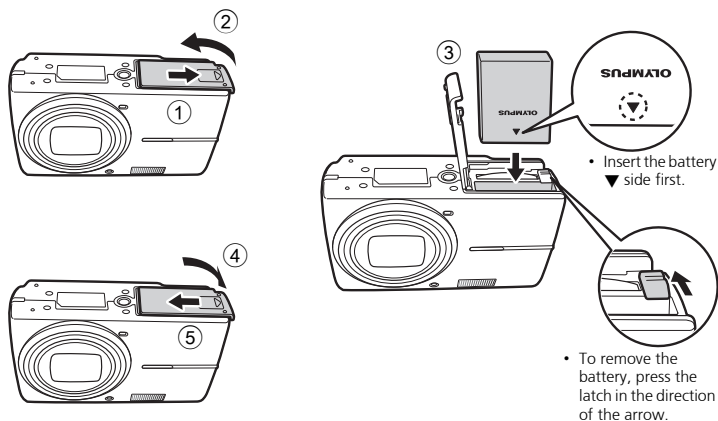

- For details on inserting an optional xD-Picture Card (hereinafter called the card), please refer to Advanced Manual.

Turn on the power

This section explains how to turn on the camera in shooting mode.

a. Set the mode dial to **AUTO**

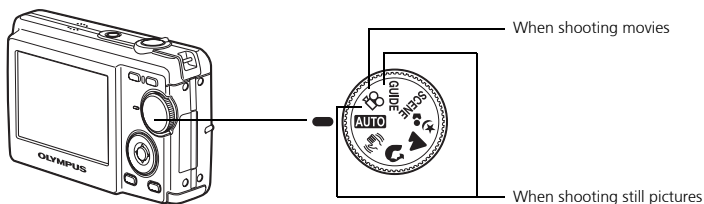

En

Still picture shooting modes

AUTO	The camera determines the optimum settings and shoots the picture.
	This function reduces the blur caused by a moving subject or camera movement when taking pictures.
	Suitable for taking pictures of people.
	Suitable for taking pictures of landscapes.
	Suitable for taking pictures of people at night.
SCENE	Shoot pictures by selecting a scene mode according to the situation.
GUIDE	You can set the items you want by doing the settings according to the shooting guide displayed on the screen.

b. Press the **POWER** button

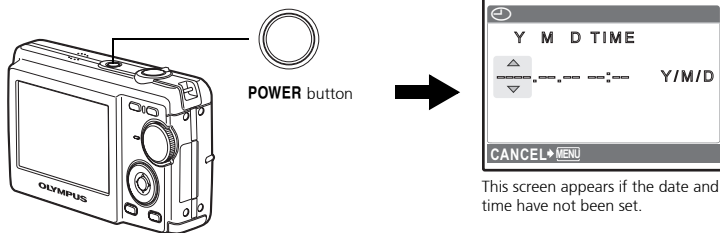

- To turn off the camera, press the **POWER** button again.

Set date and time

About the date and time setting screen

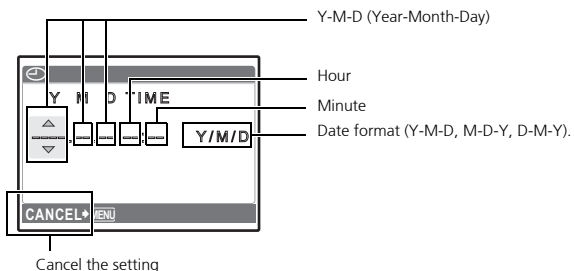

En

a. Press the Δ button and ∇ button to select [Y].

- The first two digits of the year are fixed.

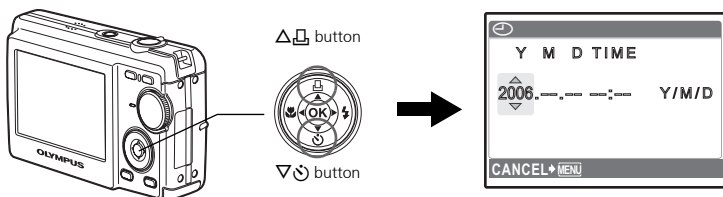

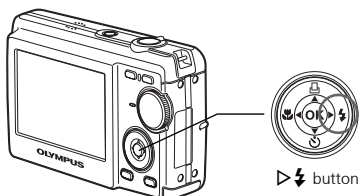

b. Press the \triangleright button.



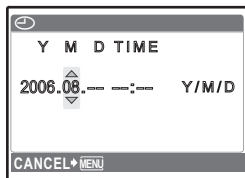

c. Press the Δ button and the ∇ button to select [M].



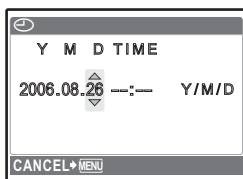

- d. Press the  button.
- e. Press the  button and the  button to select [D].

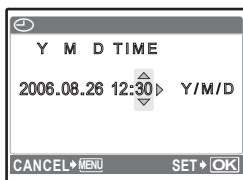

- f. Press the  button.
- g. Press the  button and the  button to select "hour" and "minute".



En

- h. Press the  button.
- i. Press the  button and  button to select year, month and date.

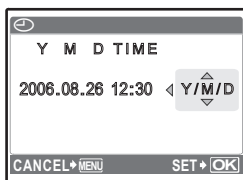

- j. After all items have been set, press .

- The time is displayed in the 24-hour format.
- For a more accurate setting, you can press  when the time signal hits 00 seconds.

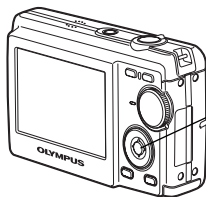

Select a Language

- a. Press the MENU button to display the top menu.

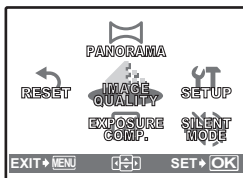
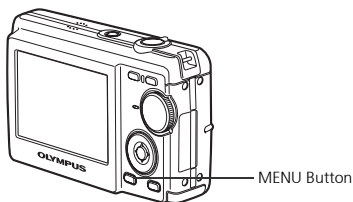

- b. Press the button to select [SETUP] and then press the button.

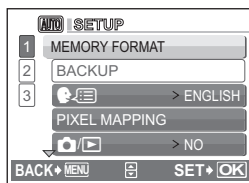
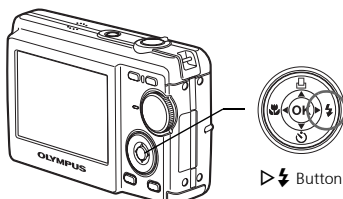

- c. Press the button to select and then press the button.

- d. Press the button and the button to select a language and then press the button.

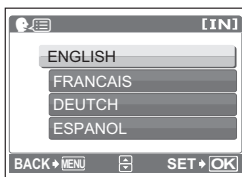
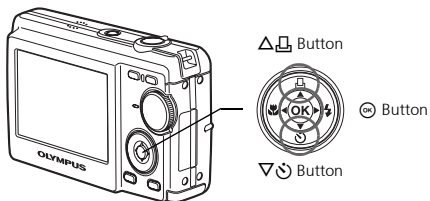

- You can add other languages to your camera with the provided OLYMPUS Master software. Please refer to the Advanced Manual.

Shoot

a. Hold the camera

Horizontal grip

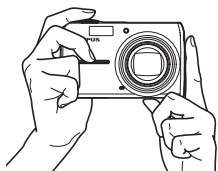

Vertical grip

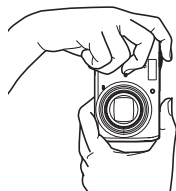

b. Focus

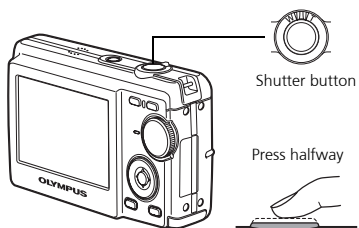

Place this mark over your subject.

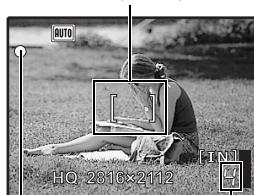

The number of still pictures you can store is displayed.

The green lamp indicates that the focus and exposure are locked.

c. Shoot

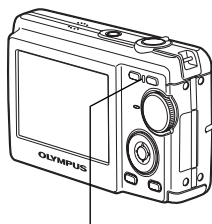
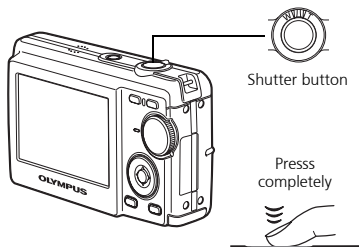

The card access lamp blinks.

View pictures

- a. Press the  button.

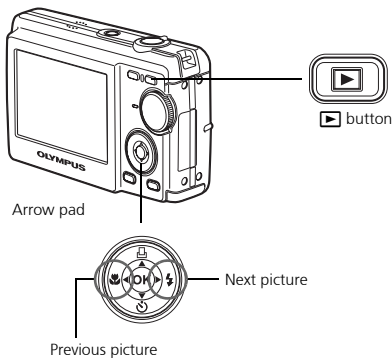

Erase pictures

- a. As described in a. above, display the picture you want to erase.
- b. Press the  button.

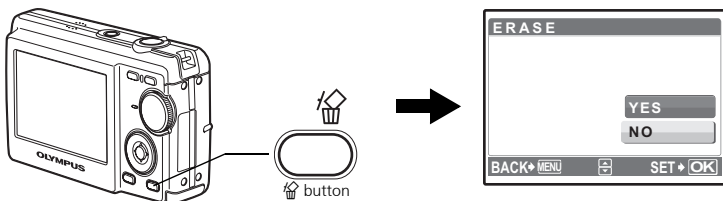

- c. Press the  button to select [YES] and press .

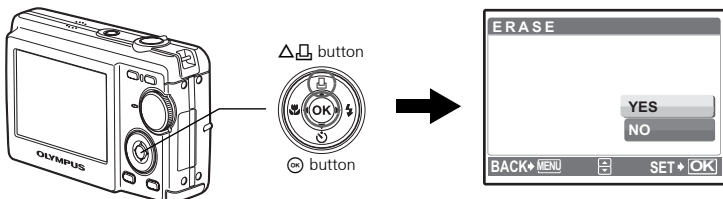







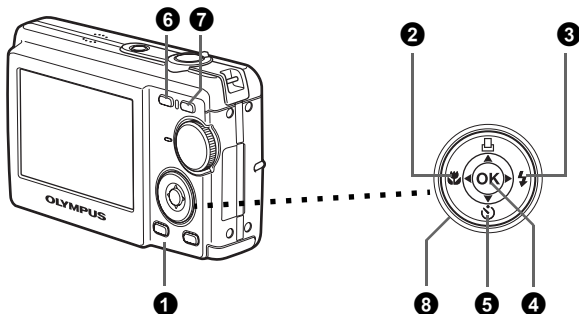





Basic Operation

Shooting Mode Buttons

While in shooting mode, use these buttons for quick access to some of the more commonly used features.



- 1 MENU button**
Displays the top menu on the monitor.
- 2  button (Macro Mode)**
Use macro or super macro mode when taking close-up pictures such as of a flower.
- 3  button (Flash Mode)**
Select from 4 flash modes - AUTO,  Red-eye reduction,  Fill-in flash, or  Flash off.
- 4  button**
Press to confirm settings.
- 5  button (Self-timer)**
Select the self-timer to delay the shot approximately 12 seconds from when the shutter button is pressed.
- 6  button (Shooting)**
Selects the shooting mode.
- 7  button (Playback)**
Selects the playback mode.
- 8 Arrow pad (   )**
Selects scenes, playback pictures and menu items.

En

Mode Dial

Set the desired mode and turn the camera on. You may select the desired mode before or during use.

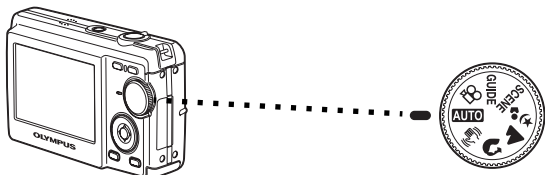

En

AUTO	Suitable for taking regular pictures.
	This function reduces the blur incurred by a moving subject or camera movement when taking pictures.
	Suitable for taking portrait pictures.
	Suitable for taking pictures of landscapes and other outdoor scenes.
	Suitable for taking pictures of your subject against a distant background.
SCENE	This function lets you select from 10 situation-related modes set to the shooting conditions.
	This function lets you record movies.
GUIDE	You can set the desired setting following the shooting guide displayed on the monitor.

SCENE Modes

Select the shooting mode depending on an object.

- 1 Set the mode dial to **SCENE**, and select the other scene.

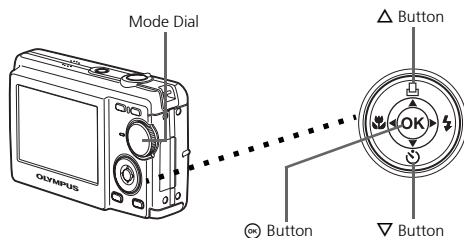
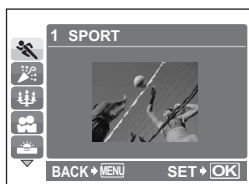



- 2 Press Δ/∇ to select the scene modes and press \ominus .





Shooting SCENE Modes

-  SPORT
-  INDOOR
-  CANDLE
-  SELF PORTRAIT
-  SUNSET
-  FIREWORKS
-  BEHIND GLASS
-  CUISINE
-  DOCUMENTS
-  AUCTION

Macro Mode

 This mode lets you take pictures as close as 20 cm (8.0 in.) to your subject. (Most wide-angle side)

 Use this mode to take pictures as close as 5 cm (2.0 in.) to your subject. In  mode, the position of the zoom lens is fixed.



① Press   repeatedly to select [] or [] and press .

Flash Modes



① Press   repeatedly to select the flash mode and press .

② Press the shutter button halfway.
• When the flash is set to fire, the  mark lights.

③ Press the shutter button completely to take the picture.

Icon	Flash Mode	Description
AUTO	Auto flash	The flash fires automatically in low light or backlight conditions.
	Red-eye reduction flash	The red-eye reduction flash mode significantly reduces this phenomenon by emitting pre-flashes before firing the regular flash.
	Fill-in flash	The flash fires regardless of the available light.
	Flash off	The flash does not fire even in low light conditions.

Self-Timer

- 1 Press ∇  to select  and press .
- 2 Press the shutter button completely to take the picture.
 - The self-timer lamp lights for approximately 10 seconds after the shutter button is pressed, then starts blinking. After blinking for approximately 2 seconds, the picture is taken.

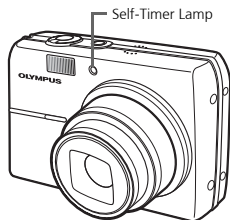

En

Power Save Feature

- To save battery power, the camera automatically enters sleep mode and stops operating if not used for approximately 3 minutes. Press the shutter button or zoom lever to reactivate the camera.
- If the camera is not operated for 15 minutes after the camera enters sleep mode, it automatically retracts the lens and turns off. To resume operation, turn on the power again.

Menus and Settings

Top Menu

- 1 Press **MENU** to display the top menu.

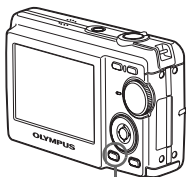

MENU

Top menu in shooting mode

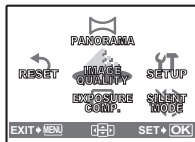

- 2 Use the arrow pad ($\Delta/\nabla/\triangleleft/\triangleright$) to select menu items, and press **OK** to set them.

PANORAMA

Panorama shooting lets you create a panoramic picture, using the OLYMPUS Master software from the provided CD-ROM. An Olympus xD-Picture Card is required for panorama shooting.

RESET

Return the changed shooting functions back to default settings.

IMAGE QUALITY

Set the image quality of the picture you will shoot according to its intended purpose.

SETUP

Set the date, time, language, and operation sound, etc.

EXPOSURE COMP. (Exposure Compensation)

Use this setting to overexpose (+) or underexpose (-) a picture.

SILENT MODE

Mute operational sounds that occur during shooting and playback.

Erase All Pictures

- 1 Press **MENU** in playback mode to display the top menu and select [ERASE] > [ALL ERASE].
- 2 Select [YES], and press **OK**.
 - All the pictures are erased.

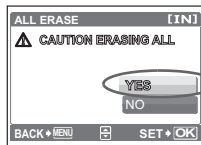

En





Connecting the Camera

Playback on a TV

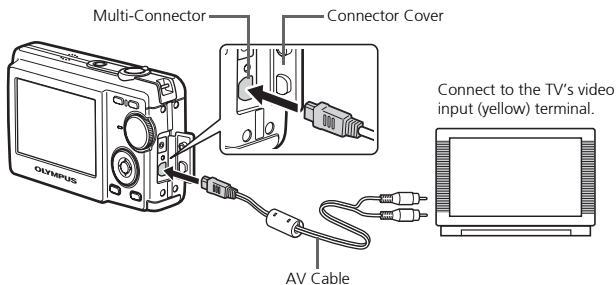
Use the AV cable provided with the camera to playback recorded images on your TV. Both still pictures and movies can be played back.

- 1 Make sure that the TV and camera are turned off. Connect the multi-connector on the camera to the video input terminal on the TV using the AV cable.



- 2 Turn the TV on and set it to the video input mode.
 - For details of switching to video input, refer to your TV's instruction manual.
- 3 Turn on the camera and then press  to enter playback mode.
 - The last picture taken is displayed on the TV. Use the arrow pad (///) to select the picture you want to display.

En

Direct Printing (PictBridge)

Using the provided USB cable, you may connect your camera directly to a PictBridge compatible printer such as the Olympus P-11 to make prints. You can print a picture with simple operations.

- 1 In playback mode, display the picture you want to print out on the monitor.
- 2 Connect one end of the provided USB cable into the camera's multi-connector and the other end into the printer's USB connector.

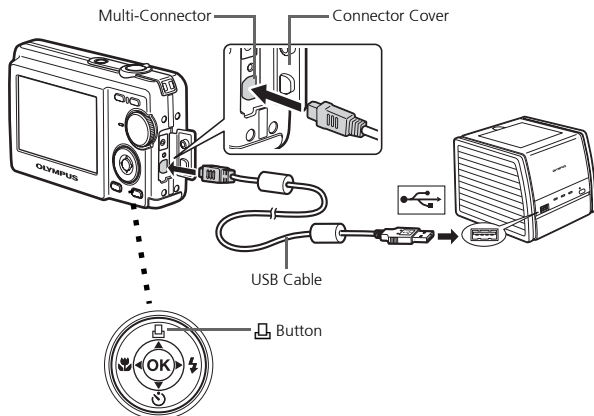

- 3 Press .
 - Printing starts.
 - When printings finished, disconnect the USB cable from the camera with the picture selection screen displayed.

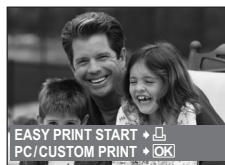

Transfer Images

Install the software

- 1 Insert the OLYMPUS Master CD-ROM.
- 2 **Windows:** Click the "OLYMPUS Master" button.
Macintosh: Double-click the "Installer" icon.
- 3 Simply follow the on-screen instructions.



En

Connect the camera to the computer

- 1 Connect the camera and computer using the USB cable (included).
 - The monitor will turn on automatically.

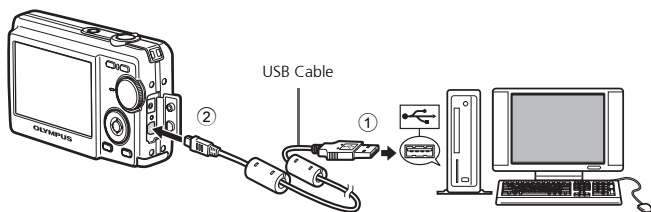

- 2 Select [PC] on the monitor, and press **OK**.

- Your PC will now recognize your camera as a removable storage drive.

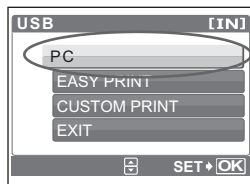

Transfer images to the computer

- 1 With the camera now connected, open OLYMPUS Master.
 - The [Transfer Images] window is displayed.
- 2 Select the images you want to transfer, and click the [Transfer Images] button.

[Transfer Images] window

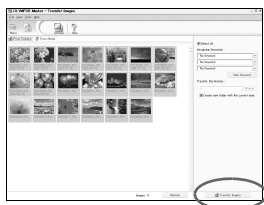

[Transfer Images] button

En

If the [Transfer Images] window is not displayed automatically:

- a. Click the "Transfer Images" icon on the OLYMPUS Master main menu.
- b. Click the "From Camera" icon.



Tips

- For more detailed information regarding camera setup and usage, please refer to the camera's "Advanced Manual" provided on CD-ROM.
- For more details on using the OLYMPUS Master software, please refer to the (electronic) reference manual located in the OLYMPUS Master folder on your hard drive. For additional assistance, refer to the "Help" file in the OLYMPUS Master software.

OLYMPUS Master Software

OLYMPUS Master Software: Use this software to download pictures from the camera, view, organize, retouch, e-mail and print your digital pictures and movies and more! This CD also contains the complete software reference manual in Adobe Acrobat (PDF) format.



● System Requirements

OS	Windows 98SE/Me/2000 Professional/XP or Mac OS X (10.2 or later)
CPU	Pentium III 500 MHz/Power PC G3, or faster
RAM	128 MB or more (256 MB or more recommended)
Hard Disk	300 MB or more free space
Connection	USB port
Monitor	1024 × 768 pixels resolution or more with minimum 65,536 colors (Windows), 32,000 colors (Macintosh)

En

For the latest support information, visit the Olympus website (<http://www.olympus.com/digital>)

● Upgrade (OLYMPUS Master Plus)

In addition to the functions in OLYMPUS Master, the OLYMPUS Master Plus features movie editing, album printing, contact sheet printing, HTML album, free stitch panorama, CD/DVD writing functions, and a lot more, allowing you to greatly expand your digital photograph capabilities.

You can upgrade your software to OLYMPUS Master Plus via the Internet.

You need to have OLYMPUS Master installed in a computer with an Internet connection.



User Registration

Register your camera when you install OLYMPUS Master to activate your warranty, receive notifications of software and camera firmware updates, and more.

Specifications

● Camera

Product type	: Digital camera (for shooting and displaying)
Recording system	
Still pictures	: Digital recording, JPEG (DCF compatible)
Applicable standards	: Exif 2.2, DPOF, PRINT Image Matching III, PictBridge
Movie	: QuickTime Motion JPEG compatible
Memory	: Internal memory xD-Picture Card (16 MB to 1 GB)
No. of effective pixels	: 6,000,000 pixels
Image pickup device	: 1/2.5" CCD (primary color filter) 6,400,000 pixels (gross)
Lens	: Olympus lens 4.6 to 23 mm, F3.3 to 4.8 (equivalent to 28 to 140 mm on 35 mm film)
Photometric system	: Digital ESP metering
Shutter speed	: 4 to 1/2000 sec.
Shooting range	: 0.2 m (0.7 ft.) to ∞ (W) 0.5 m (1.6 ft.) to ∞ (T) (normal/ macro mode) 0.05 m (2.0 in.) to 0.2 m (7.9 in.) (W only) (super macro mode)
Monitor:	: 2.5" TFT color LCD display, 153,600 pixels
Outer connector	: DC-IN jack, USB connector/AV out jack (Multi-connector)
Automatic calendar system	: Automatic update from 2000 to 2099
Operating environment	
Temperature	: 0 to 40°C (32°F to 104°F) (operation)/-20 to 60°C (-4°F to 140°F) (storage)
Humidity	: 30 to 90% (operation)/10 to 90% (storage)
Power supply	: One lithium ion battery (LI-12B/LI-10B specified by Olympus) or the specified AC adapter
Dimensions	: 97.5 mm (W) × 59 mm (H) × 27 mm (D) (3.9 × 2.4 × 1.1 in.) (excluding protrusions)
Weight	: 155 g (5.5 oz) (without battery and card)

En

● **Lithium ion battery (LI-12B)**

Product type	: Lithium ion rechargeable battery
Standard voltage	: DC 3.7 V
Standard capacity	: 1,230 mAh
Battery life	: Approx. 300 full recharges (varies on usage)
Operating environment	
Temperature	: 0°C to 40°C (32°F to 104°F) (charging)/ -10°C to 60°C (14°F to 140°F) (operation)/ 0°C to 30°C (32°F to 86°F) (storage)
Dimensions	: 32 × 46 × 10 mm (1.3 × 1.8 × 0.4 in.)
Weight	: Approx. 30 g (1.1 oz)

En

● **Battery charger (LI-10C)**

Power requirements	: AC 100 to 240 V (50 to 60 Hz) 11 VA (100 V) to 17 VA (240 V)
Output	: DC 4.2 V, 860 mA
Charging time	: Approx. 120 min.
Operating environment	
Temperature	: 0°C to 40°C (32°F to 104°F) (operation)/ -20°C to 60°C (-4°F to 140°F) (storage)
Dimensions	: 46 × 36.5 × 80 mm (1.8 × 1.5 × 3.2 in.)
Weight	: Approx. 70 g (2.5 oz)

Design and specifications subject to change without notice.

Safety Precautions



CAUTION

RISK OF ELECTRIC SHOCK
DO NOT OPEN



CAUTION: TO REDUCE THE RISK OF ELECTRICAL SHOCK, DO NOT REMOVE COVER (OR BACK). NO USER-SERVICEABLE PARTS INSIDE. REFER SERVICING TO QUALIFIED OLYMPUS SERVICE PERSONNEL.



An exclamation mark enclosed in a triangle alerts you to important operating and maintenance instructions in the documentation provided with the product.



DANGER

If the product is used without observing the information given under this symbol, serious injury or death may result.



WARNINGS

If the product is used without observing the information given under this symbol, injury or death may result.



CAUTION

If the product is used without observing the information given under this symbol, minor personal injury, damage to the equipment, or loss of valuable data may result.

WARNING!

TO AVOID THE RISK OF FIRE OR ELECTRICAL SHOCK, NEVER DISASSEMBLE, EXPOSE THIS PRODUCT TO WATER OR OPERATE IN A HIGH HUMIDITY ENVIRONMENT.

General Precautions

Read All Instructions — Before you use the product, read all operating instructions.

Save all manuals and documentation for future reference.

Cleaning — Always unplug this product from the wall outlet before cleaning. Use only a damp cloth for cleaning. Never use any type of liquid or aerosol cleaner, or any type of organic solvent to clean this product.

Attachments — For your safety, and to avoid damaging the product, use only accessories recommended by Olympus.

Water and Moisture — For precautions on products with weatherproof designs, read the weatherproofing sections.

Location — To avoid damage to the product, mount the product securely on a stable tripod, stand, or bracket.

Power Source — Connect this product only to the power source described on the product label.

Lightning — If a lightning storm occurs while using an AC adapter, remove it from the wall outlet immediately.

Foreign Objects — To avoid personal injury, never insert a metal object into the product.

Heat — Never use or store this product near any heat source such as a radiator, heat register, stove, or any type of equipment or appliance that generates heat, including stereo amplifiers.

En

Handling the Camera



WARNING

- **Do not use the camera near flammable or explosive gases.**
- **Do not use the flash on people (infants, small children, etc.) at close range.**
 - You must be at least 1 m (3 ft.) away from the faces of your subjects. Firing the flash too close to the subject's eyes could cause a momentary loss of vision.
- **Keep young children and infants away from the camera.**
 - Always use and store the camera out of the reach of young children and infants to prevent the following dangerous situations which could cause serious injury:
 - Becoming entangled in the camera strap, causing strangulation.
 - Accidentally swallowing the battery, cards or other small parts.
 - Accidentally firing the flash into their own eyes or those of another child.
 - Accidentally being injured by the moving parts of the camera.
- **Do not look at the sun or strong lights with the camera.**
- **Do not use or store the camera in dusty or humid places.**
- **Do not cover the flash with a hand while firing.**



CAUTION

- **Stop using the camera immediately if you notice any unusual odors, noise, or smoke around it.**
 - Never remove the batteries with bare hands, which may cause a fire or burn your hands.
- **Never hold or operate the camera with wet hands.**
- **Do not leave the camera in places where it may be subject to extremely high temperatures.**
 - Doing so may cause parts to deteriorate and, in some circumstances, cause the camera to catch fire. Do not use the charger or AC adapter if it is covered (such as a blanket). This could cause overheating, resulting in fire.
- **Handle the camera with care to avoid getting a low-temperature burn.**
 - When the camera contains metal parts, overheating can result in a low-temperature burn. Pay attention to the following:
 - When used for a long period, the camera will get hot. If you hold on to the camera in this state, a low-temperature burn may be caused.
 - In places subject to extremely cold temperatures, the temperature of the camera's body may be lower than the environmental temperature. If possible, wear gloves when handling the camera in cold temperatures.
- **Be careful with the strap.**
 - Be careful with the strap when you carry the camera. It could easily catch on stray objects - and cause serious damage.

Battery Handling Precautions

Follow these important guidelines to prevent batteries from leaking, overheating, burning, exploding, or causing electrical shocks or burns.

DANGER

- The camera uses a lithium ion battery specified by Olympus. Charge the battery with the specified charger. Do not use any other chargers.
- Never heat or incinerate batteries.
- Take precautions when carrying or storing batteries to prevent them from coming into contact with any metal objects such as jewelry, pins, fasteners, etc.
- Never store batteries where they will be exposed to direct sunlight, or subjected to high temperatures in a hot vehicle, near a heat source, etc.
- To prevent causing battery leaks or damaging their terminals, carefully follow all instructions regarding the use of batteries. Never attempt to disassemble a battery or modify it in any way, by soldering, etc.
- If battery fluid gets into your eyes, flush your eyes immediately with clear, cold running water and seek medical attention immediately.
- Always store batteries out of the reach of small children. If a child accidentally swallows a battery, seek medical attention immediately.

WARNING

- Keep batteries dry at all times.
- To prevent batteries from leaking, overheating, or causing a fire or explosion, use only batteries recommended for use with this product.
- Insert the battery carefully as described in the operating instructions.
- If rechargeable batteries have not been recharged within the specified time, stop charging them and do not use them.
- Do not use a battery if it is cracked or broken.
- If a battery leaks, becomes discolored or deformed, or becomes abnormal in any other way during operation, stop using the camera.
- If a battery leaks fluid onto your clothing or skin, remove the clothing and flush the affected area with clean, running cold water immediately. If the fluid burns your skin, seek medical attention immediately.
- Never subject batteries to strong shocks or continuous vibration.

CAUTION

- Before loading, always inspect the battery carefully for leaks, discoloration, warping, or any other abnormality.
- The battery may become hot during prolonged use. To avoid minor burns, do not remove it immediately after using the camera.
- Always unload the battery from the camera before storing the camera for a long period.

For customers in North and South America

For customers in USA

Declaration of Conformity

Model Number : FE-200

Trade Name : OLYMPUS

Responsible Party : **OLYMPUS IMAGING AMERICA INC.**

Address : 3500 Corporate Parkway, P.O. Box 610, Center Valley,
PA 18034-0610, U.S.A.

Telephone Number : 484-896-5000

Tested To Comply With FCC Standards

FOR HOME OR OFFICE USE

This device complies with Part 15 of the FCC rules. Operation is subject to the following two conditions:

- (1) This device may not cause harmful interference.
- (2) This device must accept any interference received, including interference that may cause undesired operation.

For customers in Canada

This Class B digital apparatus meets all requirements of the Canadian Interference-Causing Equipment Regulations.

En

Trademarks

- IBM is a registered trademark of International Business Machines Corporation.
- Microsoft and Windows are registered trademarks of Microsoft Corporation.
- Macintosh is a trademark of Apple Computer Inc.
- xD-Picture Card™ is a trademark.
- All other company and product names are registered trademarks and/or trademarks of their respective owners.
- The standards for camera file systems referred to in this manual are the "Design Rule for Camera File System/DCF" standards stipulated by the Japan Electronics and Information Technology Industries Association (JEITA).

Memo

Table des matières

Réunissez ces éléments (contenu de la boîte)	29
Préparez la batterie	30
Mise sous tension	31
Régler la date et l'heure	32
Sélection d'une langue	34
Photographier	35
Visionner les photos	36
Fonctionnement de base	37
Touches du mode prise de vue	37
Molette mode	38
Modes SCENE (Scène).....	38
Mode gros plan.....	39
Modes flash	39
Retardateur	40
Fonctionnalité d'économie d'énergie.....	40
Menus et réglages	41
Menu principal.....	41
Effacement de toutes les photos	41
Connexion de l'appareil photo	42
Affichage sur un téléviseur	42
Impression directe (PictBridge).....	43
Transfert d'images	44
Logiciel OLYMPUS Master	46
Caractéristiques	47
Précautions de sécurité	49
● Avant d'utiliser votre appareil photo et pour garantir une utilisation correcte, lisez attentivement ce manuel.	
● Nous vous recommandons de prendre des photos-test pour vous habituer à votre appareil avant de commencer à prendre de vraies photos.	
● Veillez à ce que les mesures de sécurité présentées à la fin de ce manuel soient respectées.	
● Les captures de l'écran ACL et les illustrations de l'appareil photo utilisées dans ce manuel peuvent être différentes du produit réel.	

Réunissez ces éléments (contenu de la boîte)



Appareil photo numérique



Dragonne



Batterie LI-12B au lithium-ion

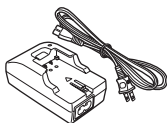

Chargeur de batterie LI-10C

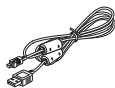

Câble USB

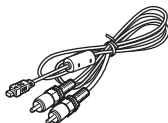

Câble AV



CD-ROM OLYMPUS Master

Autres éléments

- Manuel de base (ce manuel)
- Manuel avancé
- Carte de garantie

Le contenu est susceptible de varier en fonction du lieu d'achat.

Attachez la dragonne

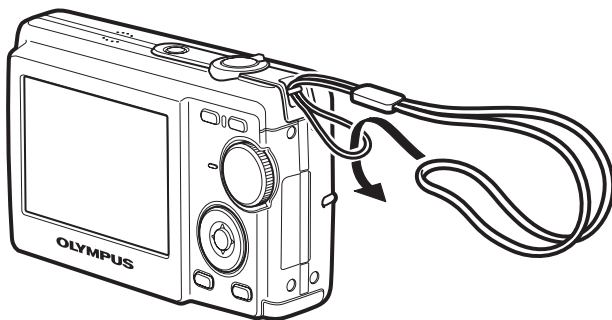

- Tirez fort sur la dragonne afin qu'elle ne se détache pas.

Préparez la batterie

a. Chargez la batterie

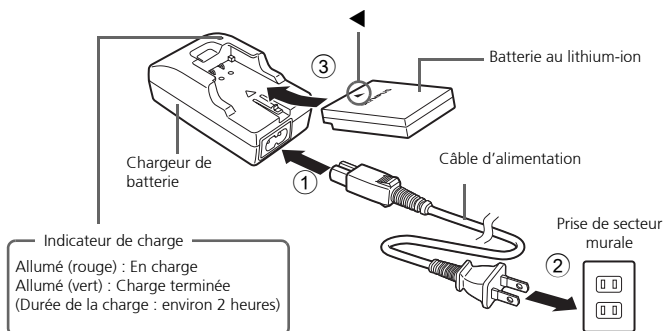

Fr

- La batterie est livrée partiellement chargée.

b. Insérez la batterie dans l'appareil photo

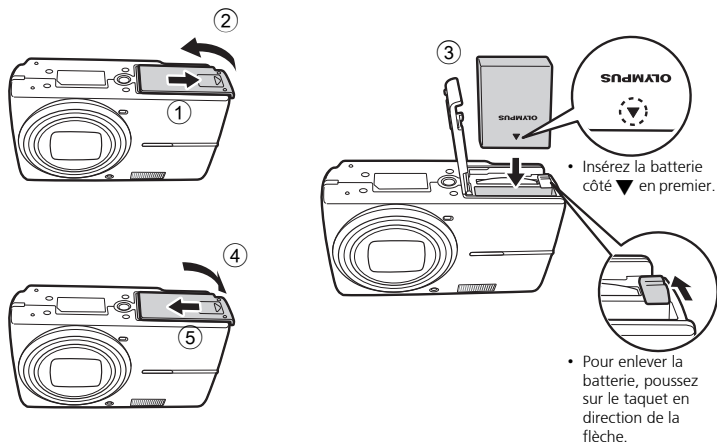

- Pour des détails sur l'insertion d'une carte xD-Picture Card (appelée ci-après carte), veuillez vous reporter au manuel avancé.

Mise sous tension

Cette section décrit comment mettre l'appareil photo en mode prise de vue.

a. Amenez la molette mode sur **AUTO**

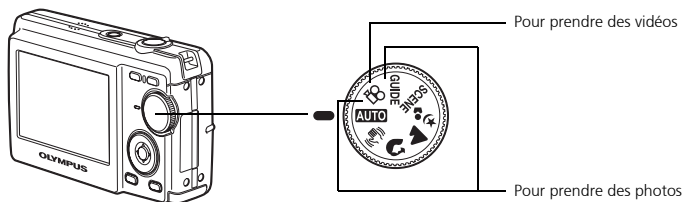

Modes de prise de vue de photos

AUTO	L'appareil détermine les réglages optimaux et prend la photo.
	Cette fonction réduit le flou dû à un mouvement du sujet ou un bougé de l'appareil lors de la prise de vue.
	Convient à des prises de vue de personnes.
	Convient à des prises de vue de paysages.
	Convient à des prises de vue de personnes de nuit.
SCÈNE	Prenez des photos en sélectionnant un mode scène en fonction des conditions.
GUIDE	Vous pouvez régler les éléments que vous voulez en effectuant les réglages en fonction du guide des prises de vue affiché à l'écran.

b. Appuyez sur la touche **POWER**

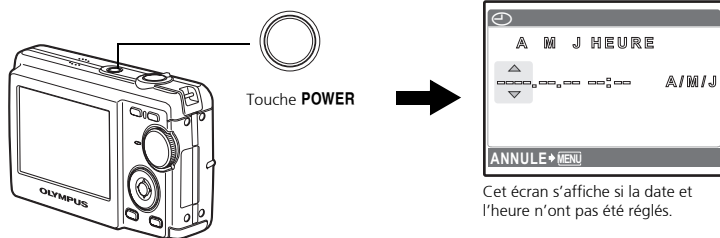

Cet écran s'affiche si la date et l'heure n'ont pas été réglés.

- Pour mettre l'appareil hors tension, appuyez à nouveau sur la touche **POWER**.

Régler la date et l'heure

A propos de l'écran de réglage de la date et de l'heure

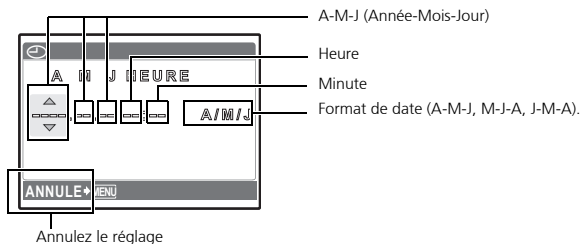

Fr a. Appuyez sur la touche Δ \square et la touche ∇ \odot pour sélectionner [A].

- Les deux premiers chiffres de l'année sont fixes.

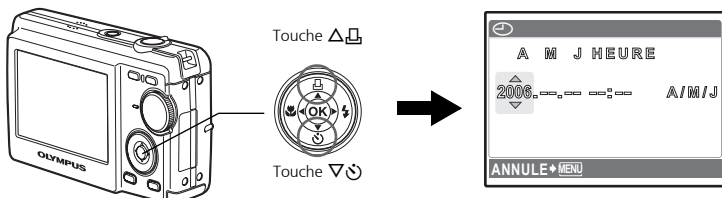

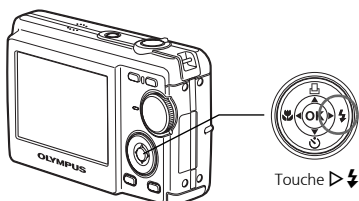

b. Appuyez sur la touche \triangleright ζ .



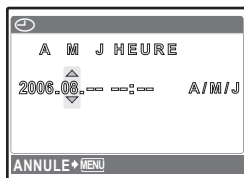

c. Appuyez sur la touche Δ \square et la touche ∇ \odot pour sélectionner [M].



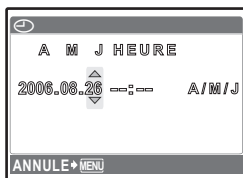

- d. Appuyez sur la touche .
- e. Appuyez sur la touche  et la touche  pour sélectionner [J].



- f. Appuyez sur la touche .
- g. Appuyez sur la touche  et sur la touche  pour sélectionner "heure" et "minute".



- h. Appuyez sur la touche .
- i. Appuyez sur la touche  et la touche  pour sélectionner l'année, le mois et le jour.

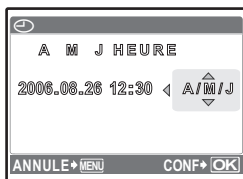

- j. Après avoir réglé tous les éléments, appuyez sur .

- L'heure s'affiche au format 24 heures.
- Pour un réglage plus précis, vous pouvez appuyez sur  lorsque l'heure atteint 00 secondes.

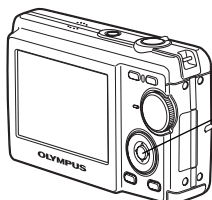

Sélection d'une langue

- a. Appuyez sur la touche MENU pour afficher le menu principal.

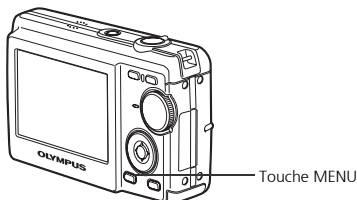

- b. Appuyez sur la touche pour sélectionner [REGLAGE] et appuyez ensuite sur la touche .

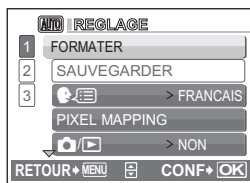
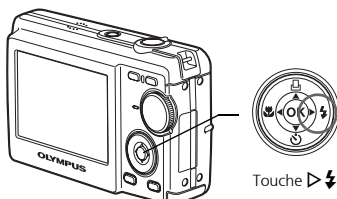

- c. Appuyez sur la touche pour sélectionner et appuyez ensuite sur la touche .
- d. Appuyez sur la touche et la touche pour sélectionner une langue et appuyez ensuite sur la touche .

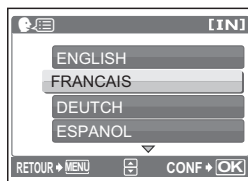
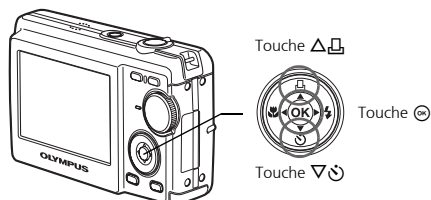

- Vous pouvez ajouter d'autres langues à l'appareil photo à l'aide du logiciel OLYMPUS Master fourni. Veuillez vous reporter au manuel avancé.

Photographier

a. Tenez l'appareil photo

Tenue horizontale

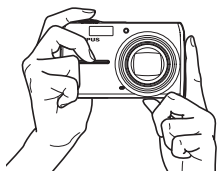

Tenue verticale



b. Mise au point

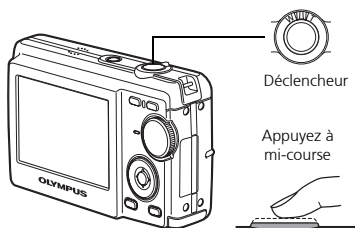

Placez ce repère sur votre sujet.

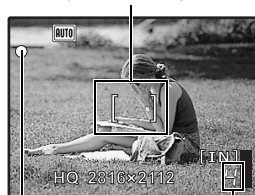

Le nombre de photos que vous pouvez enregistrer s'affiche.

Le voyant vert indique que la mise au point et l'exposition sont mémorisées.

c. Prendre la photo

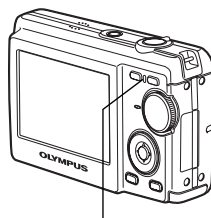
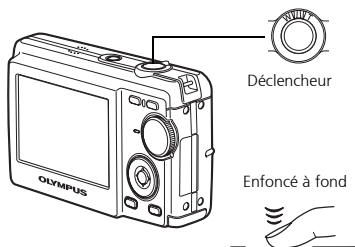

Visionner les photos

a. Appuyez sur la touche .

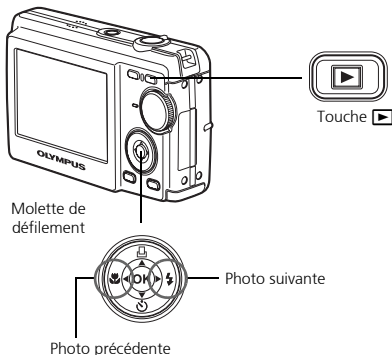



Effacer les photos

a. Comme décrit au point a. ci-dessus, affichez la photo que vous voulez effacer.

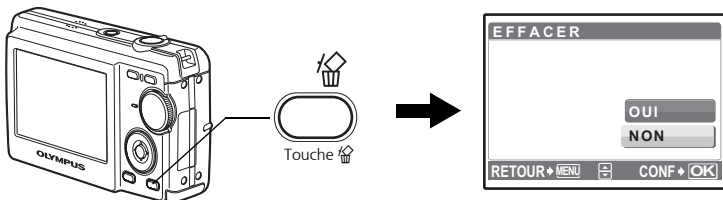
b. Appuyez sur la touche .





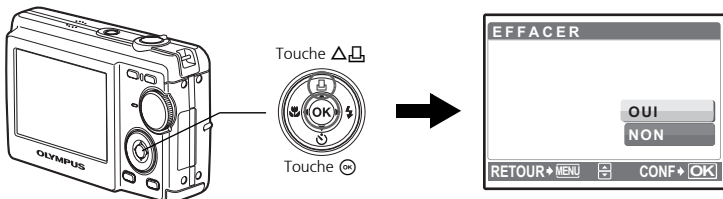





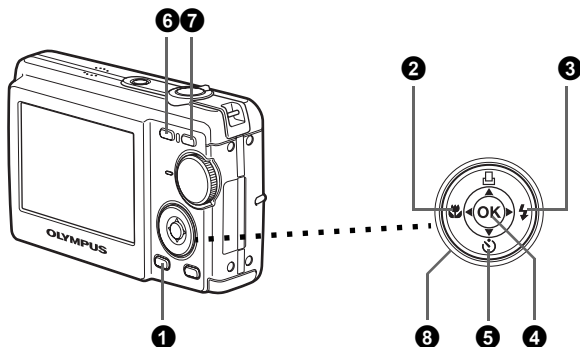





c. Appuyez sur la touche  pour sélectionner [OUI] et appuyez sur .



Touches du mode prise de vue

Lorsque vous êtes en mode prise de vue, ces touches vous permettent d'accéder rapidement à certaines des fonctions les plus utilisées.



- 1 Touche MENU**
Affiche le menu principal sur l'écran ACL.
- 2 Touche  (Mode Gros Plan)**
Utilisez le mode gros plan ou super gros plan lorsque vous prenez des photos en gros plan, telle que la photo d'une fleur.
- 3 Touche  (Mode Flash)**
Sélectionnez un des quatre modes flash - AUTO,  Réduction yeux rouges,  Flash d'appoint, ou  Flash désactivé.
- 4 Touche **
Appuyez pour confirmer les réglages.
- 5 Touche  (Retardateur)**
Sélectionnez le retardateur pour retarder la prise de vue d'environ 12 secondes une fois que le déclencheur a été enfoncé.
- 6 Touche  (Prise de vue)**
Sélectionne le mode de prise de vue.
- 7 Touche  (Lecture)**
Sélectionne le mode lecture.
- 8 Molette de défilement (   )**
Sélectionne les scènes, les photos à visionner et les éléments du menu.

Molette mode

Sélectionnez le mode souhaité et allumez l'appareil photo. Vous pouvez sélectionner le mode souhaité avant ou pendant l'utilisation.

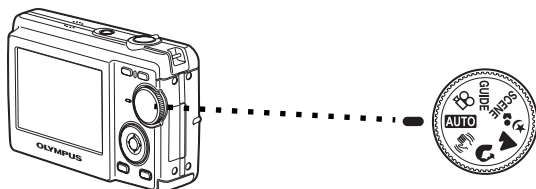

Fr

AUTO	Convient pour prendre des photos normales.
	Cette fonction réduit le flou dû à un mouvement du sujet ou un bougé de l'appareil lors de la prise de vue.
	Convient pour prendre des portraits.
	Convient à des prises de vue de paysages et autres scènes d'extérieur.
	Convient pour prendre des photos de votre sujet contre un arrière plan éloigné.
SCENE	Cette fonction vous permet de sélectionner l'un des dix modes de situation en fonction des conditions de prise de vue.
	Cette fonction vous permet d'enregistrer des vidéos.
GUIDE	Vous pouvez régler les paramètres souhaités selon le guide de prise de vue affiché à l'écran.

Modes SCENE (Scène)

Sélectionnez le mode de prise de vue en fonction d'un objet.

- 1 Amenez la molette de mode sur **SCENE** et sélectionnez l'autre scène.

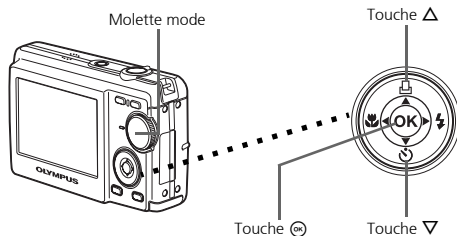
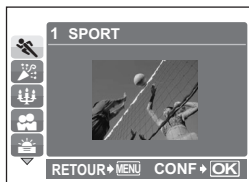

- 2 Appuyez sur Δ/∇ pour sélectionner les modes scènes et appuyez sur OK .

Prise de vue en modes SCENE

- SPORT
- INTERIEUR
- BOUGIE
- AUTO PORTRAIT
- COUCHER DE SOLEIL
- FEUX D'ARTIFICES
- VITRINE
- CUISINE
- DOCUMENTS
- ENCHÈRE

Mode gros plan





- Ce mode vous permet de prendre des photos à 20 cm du sujet. (Côté du plus grand angle)
- Utilisez ce mode pour prendre des photos à 5 cm de votre sujet. En mode , la position du zoom est fixe.
- 1 Appuyez à plusieurs reprises sur pour sélectionner [] ou [] et appuyez sur .

Modes flash

- 1 Appuyez à plusieurs reprises sur pour sélectionner le mode flash et appuyez sur .
- 2 Appuyez sur le déclencheur jusqu'à mi-course.
- Lorsque le flash est réglé pour se déclencher, l'indication s'allume.
- 3 Enfoncez le déclencheur à fond pour prendre la photo.

Icône	Mode flash	Description
AUTO	Flash automatique	Le flash se déclenche automatiquement lorsque l'éclairage est faible ou à contre-jour.
	Flash atténuant l'effet "yeux rouges"	Ce mode permet d'atténuer considérablement l'effet "yeux rouges" en émettant une série de pré-éclairs avant de déclencher le flash principal.
	Flash d'appoint	Le flash se déclenche quelles que soient les conditions d'éclairage.
	Flash désactivé	Le flash ne se déclenche pas, même dans des situations de faible éclairage.

Retardateur

- 1 Appuyez sur   pour sélectionner [] et appuyez sur .
- 2 Enfoncez le déclencheur à fond pour prendre la photo.
 - Le voyant du retardateur s'allume pendant environ 10 secondes après que le déclencheur ait été enfoncé, puis il clignote. La photo est prise après environ 2 secondes de clignotement.

Voyant du retardateur

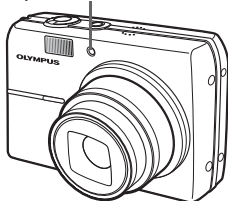

Fonctionnalité d'économie d'énergie

Fr

- Pour économiser l'énergie de la batterie, l'appareil photo passe automatiquement en mode veille et cesse de fonctionner après 3 minutes d'inactivité. Appuyez sur le déclencheur ou la touche de zoom pour réactiver l'appareil photo.
- Une fois qu'il est entré en mode veille, si l'appareil n'est toujours pas utilisé au bout de 15 minutes, l'objectif se rétracte automatiquement et l'appareil s'éteint. Pour l'utiliser à nouveau, remettez-le sous tension.

Menus et réglages

Menu principal

- 1 Appuyez sur la touche **MENU** pour afficher le menu principal.

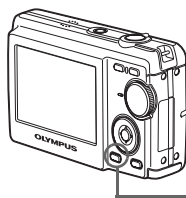

MENU

Menu principal en mode prise de vue



- 2 Utilisez la molette de défilement ($\Delta/\nabla/\leftarrow/\rightarrow$) pour sélectionner les éléments du menu et appuyez sur \odot pour les régler.

PANORAMIQUE

La prise de vue panoramique vous permet de créer une photo panoramique grâce au logiciel OLYMPUS Master contenu dans le CD-ROM fourni. Une carte Olympus xD-Picture Card est nécessaire pour la prise de vue panoramique.

REINITIALISER

Réinitialisez, à leurs valeurs d'origine, les fonctions de prise de vue qui ont été modifiées.

QUALITE D'IMAGE

Définissez la qualité des images prises en fonction de l'utilisation prévue.

REGLAGE

Réglez la date, l'heure, la langue, le son lié au fonctionnement, etc.

COMPENSATION D'EXPOSITION (Compensation d'exposition)

Ce réglage vous permet de surexposer (+) ou sous-exposer (-) une photo.

MODE SILENCIEUX

Eteint les sons liés au fonctionnement, pendant la prise de vue et la lecture.

Fr

Effacement de toutes les photos

- 1 Appuyez sur **MENU** en mode lecture pour afficher le menu principal et sélectionnez [EFFACER] > [TOUT EFFAC].

- 2 Sélectionnez [OUI] et appuyez sur \odot .

- Toutes les images sont effacées.

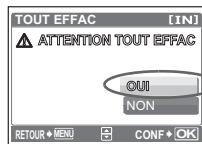





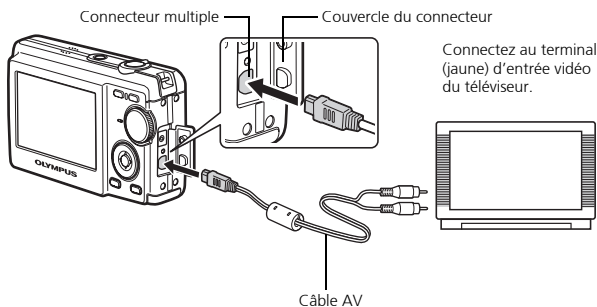

Connexion de l'appareil photo

Affichage sur un téléviseur

Utilisez le câble vidéo fourni avec l'appareil photo pour visualiser les images enregistrées directement sur votre téléviseur. Vous pouvez lire ainsi à la fois les images fixes et les vidéos.

- 1 Assurez-vous que le téléviseur et l'appareil photo sont éteints. Branchez le connecteur multiple de l'appareil photo à la prise d'entrée vidéo du téléviseur avec le câble AV.





- 2 Allumez le téléviseur et mettez-le en mode entrée vidéo.
 - Pour en savoir plus sur le passage en entrée vidéo, veuillez consulter le mode d'emploi du téléviseur.
- 3 Mettez l'appareil sous tension et appuyez ensuite sur  pour passer en mode lecture.
 - La dernière photo prise est affichée sur le téléviseur. Utilisez la molette de défilement (///) pour sélectionner la photo à afficher.

Impression directe (PictBridge)

A l'aide du câble USB fourni avec l'appareil, vous pouvez connecter votre appareil photo directement à une imprimante compatible PictBridge telle que l'Olympus P-11 pour effectuer des impressions. Vous pouvez de manière très simple, imprimer une photo .

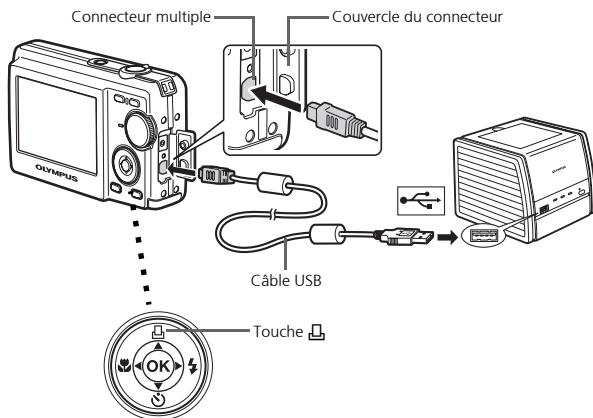
- 1 En mode lecture, affichez à l'écran la photo que vous souhaitez imprimer.
- 2 Connectez une des extrémités du câble USB dans le connecteur multiple de l'appareil photo et l'autre dans le connecteur USB de l'imprimante.



- 3 Appuyez sur .

 - L'impression démarre.
 - Lorsque l'impression est terminée, déconnectez le câble USB de l'appareil photo avec l'écran de sélection des photos affiché.



Transfert d'images

Installez le logiciel

- 1 Insérez le CD-ROM OLYMPUS Master.
- 2 **Windows:** Cliquez sur la touche "OLYMPUS Master".
Macintosh: Double-cliquez sur l'icône "Installeur".
- 3 Suivez simplement les instructions à l'écran.



Fr

Connectez l'appareil photo à l'ordinateur

- 1 Connectez l'appareil photo et l'ordinateur à l'aide du câble USB (fourni).
 - L'écran ACL s'allume automatiquement.

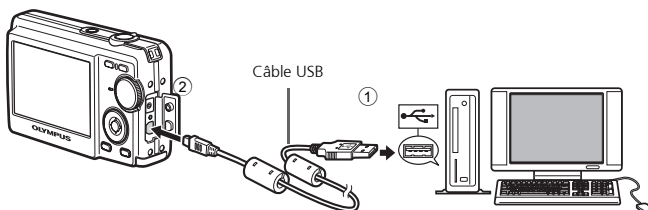

- 2 Sélectionnez [PC] sur l'écran ACL et appuyez sur .

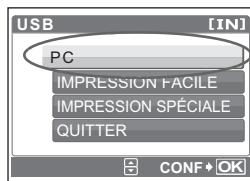

- Votre ordinateur reconnaît maintenant votre appareil photo comme unité de stockage amovible.

Transférez les images vers l'ordinateur

- 1 Gardez votre appareil photo connecté, puis ouvrez OLYMPUS Master.
 - La fenêtre [Transférer des images] s'affiche.
- 2 Sélectionnez les images que vous souhaitez transférer et cliquez sur le bouton [Transférer des images].

Fenêtre [Transférer des images]

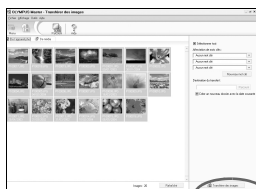

Touche [Transférer des images]

Si la fenêtre [Transférer des images] n'est pas affichée automatiquement :

- a. Cliquez sur l'icône "Transférer Images" du menu principal d'OLYMPUS Master.
- b. Cliquez sur l'icône "Depuis l'appareil photo".



Conseils

- Pour des informations plus détaillées concernant la configuration et l'utilisation de l'appareil photo, veuillez consulter le "Manuel Avancé" de l'appareil, fourni sur CD-ROM.
- Pour plus de détails concernant l'utilisation du logiciel OLYMPUS Master, veuillez consulter le manuel de référence (électronique) situé dans le dossier OLYMPUS Master de votre disque dur. Pour plus d'information, consultez le fichier d'"Aide" du logiciel OLYMPUS Master.

Logiciel OLYMPUS Master

Logiciel OLYMPUS Master: Utilisez ce logiciel pour télécharger des photos de l'appareil photo, visionner, organiser, retoucher, envoyer par e-mail, imprimer – et plus encore – vos photos numériques. Ce CD contient aussi le manuel de référence complet du logiciel en format Adobe Acrobat (PDF).



● Configurations système minimales

SE	Windows 98SE/Me/2000 Professional/XP ou Mac OS X (10.2 ou version ultérieure)
UC	Pentium III 500 MHz/Power PC G3, ou plus rapide
RAM	128 Mo ou plus (256 Mo ou plus recommandé)
Disque dur	300 Mo ou plus d'espace disque
Connexion	Port USB
Écran ACL	Résolution de 1024 x 768 pixels ou plus avec un minimum de 65 536 couleurs (Windows), 32 000 couleurs (Macintosh)

Fr

Pour obtenir les dernières informations relatives à la prise en charge, consultez le site internet Olympus
(<http://www.olympus.com/digital>)

● Mise à niveau (OLYMPUS Master Plus)

En plus des fonctions proposées par OLYMPUS Master, OLYMPUS Master Plus permet de modifier des films, d'imprimer des albums, d'imprimer des planches contacts, de créer des albums HTML, des panoramiques sans raccords, des fonctions d'écriture sur CD/DVD et plus encore, vous permettant d'augmenter grandement les capacités en matière de photographie numérique.

Vous pouvez mettre à niveau votre logiciel en OLYMPUS Master Plus via Internet. Vous devez avoir installé OLYMPUS Master sur un ordinateur équipé d'une connexion internet.



Enregistrement de l'utilisateur

Enregistrez votre appareil photo lorsque vous installez OLYMPUS Master pour activer la garantie, recevoir des notifications de logiciel et les mises à jours de micro-logiciels et plus encore.

● Appareil photo

Type de produit	: Appareil photo numérique (pour prise de vue et affichage)
Système d'enregistrement	
Photos	: Enregistrement numérique, JPEG (compatible DCF)
Standards applicables	: Exif 2.2, DPOF, PRINT Image Matching III, PictBridge
Vidéo	: QuickTime Motion compatible JPEG
Mémoire	: Mémoire interne xD-Picture Card (16 Mo to 1 Go)
Nombre de pixels efficaces	: 6 000 000 pixels
Dispositif de transfert de photos	: CCD 1/2,5" (filtre des couleurs primaires), 6 400 000 pixels (brut)
Objectif	: Objectif Olympus 4,6 à 23 mm, F3,3 à 4,8 (équivalent à 28 à 140 mm sur des films 35 mm)
Système photométrique	: Mesure ESP numérique
Vitesse d'obturation	: 4 à 1/2000 sec.
Portée de la prise de vue	: 0,2 m à ∞ (W) 0,5 m à ∞ (T) (normal/mode gros plan) 0,05 m à 0,2 m (W uniquement) (mode super gros plan)
Écran ACL :	: Écran couleur 2,5" TFT, 153 600 pixels
Connecteur extérieur	: Prise DC-IN, Connecteur USB/Prise sortie AV (Multi-connecteur)
Système de calendrier automatique	: Mise à jour automatique 2000 à 2099
Conditions de fonctionnement	
Température	: 0 à 40°C (fonctionnement)/-20 à 60°C (stockage)
Humidité	: 30 à 90% (fonctionnement)/10 à 90% (stockage)
Alimentation	: Une batterie lithium-ion (LI-12B/LI-10B spécifiée par Olympus) ou l'adaptateur secteur spécifié.
Dimensions	: 97,5 mm (L) × 59 mm (H) × 27 mm (P) (hors protubérances)
Poids	: 155 g (sans batterie ou carte)

● Batterie lithium-ion (LI-12B)

Type de produit	: Batterie lithium-ion rechargeable
Voltage standard	: DC 3,7 V
Capacité standard	: 1,230 mAh
Durée de vie de la batterie	: Environ 300 recharges pleines (varie selon l'utilisation)
Conditions de fonctionnement	
Température	: 0°C à 40°C (en charge)/ -10°C à 60°C (en fonctionnement)/ 0°C à 30°C (stockage)
Dimensions	: 32 × 46 × 10 mm
Poids	: Environ 30 g

● Chargeur de batterie (LI-10C)

Alimentation requise	: CA 100 à 240 V (50 à 60 Hz) 11 VA (100 V) à 17 VA (240 V)
Sortie	: DC 4.2 V, 860 mA
Durée de la charge	: Environ 120 min.
Conditions de fonctionnement	
Température	: 0°C à 40°C (en fonctionnement)/ -20°C à 60°C (stockage)
Dimensions	: 46 × 36.5 × 80 mm
Poids	: Environ 70 g

La conception et les caractéristiques peuvent être modifiées sans préavis.



ATTENTION

RISQUE DE DÉCHARGE ÉLECTRIQUE NE PAS OUVRIR



ATTENTION: POUR RÉDUIRE LE RISQUE DE DÉCHARGE ÉLECTRIQUE, NE RETIRER NI LA PARTIE ANTERIEURE NI POSTERIEURE DU BOITIER. AUCUNE PIÈCE À L'INTÉRIEUR NE PEUT ÊTRE RÉPARÉE PAR L'UTILISATEUR. SE RÉFÉRER À DU PERSONNEL DE DÉPANNAGE QUALIFIÉ POUR UNE RÉPARATION.



Le point d'exclamation à l'intérieur d'un triangle vous alerte sur certains points importants concernant le maniement et l'entretien de l'appareil figurant dans la documentation fournie avec le produit.



DANGER

Si le produit est utilisé sans respecter les informations données sous ce symbole, des blessures graves, voire mortelles pourraient en résulter.



AVERTISSEMENT

Si le produit est utilisé sans respecter les informations données sous ce symbole, des blessures voire la mort pourraient en résulter.



ATTENTION

Si le produit est utilisé sans observer les informations données sous ce symbole, des blessures, des dommages à l'appareil ou des pertes de données pourraient en résulter.

AVERTISSEMENT !

POUR ÉVITER LES RISQUES D'INCENDIE OU DE DÉCHARGE ÉLECTRIQUE, NE JAMAIS DÉMONTER, EXPOSER CE PRODUIT À L'EAU NI LE FAIRE FONCTIONNER DANS UN ENVIRONNEMENT TRÈS HUMIDE.

Précautions générales

Lire toutes les instructions — Avant d'utiliser l'appareil, lire toutes les instructions de fonctionnement. Sauvegarder tous les manuels et la documentation pour s'y référer ultérieurement.

Nettoyage — Toujours débrancher ce produit de la prise de courant avant nettoyage. N'utiliser qu'un chiffon humide pour le nettoyage. Ne jamais utiliser de produits de nettoyage liquides ou aérosols, ni de solvants organiques pour nettoyer ce produit.

Accessoires — Pour votre sécurité, et pour éviter d'endommager le produit, n'utiliser que des accessoires recommandés par Olympus.

Eau et humidité — Pour les précautions sur des produits avec une conception imperméable, lire les sections imperméabilisation.

Emplacement — Pour éviter d'endommager l'appareil, monter le produit solidement sur un trépied ou un sabot stable.

Alimentation — Ne raccorder ce produit qu'à la source d'alimentation décrite sur l'étiquette du produit.

Foudre — Si un orage éclate pendant l'utilisation d'un adaptateur secteur, le débrancher immédiatement de la prise de courant.

Entrée d'objets — Pour éviter des blessures, ne jamais introduire d'objet métallique dans le produit.

Chaleur — Ne jamais utiliser ni ranger ce produit près d'une source de chaleur telle qu'un radiateur, un accumulateur de chaleur, ou tout type d'appareil qui génère de la chaleur, comprenant les amplificateurs.

Maniement de l'appareil



AVERTISSEMENT

- **Ne pas utiliser l'appareil à proximité de gaz inflammables ou explosifs.**
- **Ne pas utiliser le flash de très près sur des personnes (bébés, jeunes enfants, etc.).**
 - Vous devez être au moins à 1 m des visages de vos sujets. Déclencher le flash trop près des yeux du sujet pourrait causer une perte momentanée de la vision.
- **Ne pas laisser l'appareil à la portée des enfants.**
 - Toujours utiliser et ranger l'appareil hors de la portée des jeunes enfants et des bébés pour empêcher les situations dangereuses suivantes qui pourraient causer des blessures graves :
 - S'enrouler dans la courroie de l'appareil, causant la strangulation.
 - Avaler accidentellement la batterie, des cartes ou d'autres petites pièces.
 - Déclencher accidentellement le flash dans leurs yeux ou ceux d'un autre enfant.
 - Se blesser accidentellement par des parties en mouvement de l'appareil.
- **Ne pas regarder le soleil ni de la lumière puissante avec l'appareil.**
- **Ne pas utiliser ni ranger l'appareil dans des endroits poussiéreux ou humides.**
- **Ne pas couvrir le flash avec une main pendant le déclenchement.**



ATTENTION

- **Arrêtez immédiatement d'utiliser l'appareil si vous remarquez une odeur, un bruit anormal ou de la fumée provenant de l'appareil.**
 - Ne jamais retirer les batteries les mains nues, ce qui pourrait vous brûler les mains.
- **Ne jamais manipuler l'appareil avec des mains mouillées.**
- **Ne pas laisser l'appareil dans des endroits où il pourrait être soumis à des températures très élevées.**
 - Ceci pourrait causer une détérioration de certaines pièces et, dans certaines circonstances, l'appareil pourrait prendre feu. Ne pas utiliser le chargeur ni un adaptateur secteur s'il est couvert (par exemple par une couverture). Ce qui pourrait causer une surchauffe, débouchant sur un incendie.
- **Manipuler l'appareil soigneusement afin d'éviter une brûlure à basse température.**
 - Lorsque l'appareil contient des parties métalliques, une surchauffe peut déboucher sur une brûlure à basse température. Faire attention aux points suivants :
 - Utilisé pendant une longue durée, l'appareil devient chaud. Si vous tenez l'appareil dans ces conditions, une brûlure à basse température risque de se produire.
 - Dans des endroits sujets à des températures très froides, la température du corps de l'appareil peut être plus basse que la température ambiante. Si possible, mettre des gants en tenant l'appareil à des températures basses.

● **Faire attention avec la courroie.**

- Faire attention avec la courroie en portant l'appareil. Elle peut facilement s'accrocher à des objets sur le passage et causer des dommages sérieux.

Précautions de manipulation de la batterie

Veillez suivre ces consignes importantes pour éviter le coulage du liquide de la batterie, une génération de chaleur, des brûlures, une explosion, ou de causer des décharges électriques ou brûlures.

 **DANGER**

- Cet appareil photo utilise une batterie lithium-ion spécifiée par Olympus. Chargez la batterie à l'aide du chargeur spécifié. N'utilisez aucun autre chargeur.
- Ne faites jamais chauffer les batteries et ne les brûlez jamais.
- Prenez toutes les précautions nécessaires lors du transport ou du stockage des batteries pour éviter le contact avec des objets métalliques (bijoux, épingles, trombones etc.).
- Ne stockez pas les batteries dans des endroits exposés au soleil, ne les exposez pas à des températures élevées (dans une voiture surchauffée), ne les placez pas à proximité d'une source de chaleur, etc.
- Pour éviter des fuites de la batterie ou éviter d'endommager leurs bornes, suivez attentivement les instructions concernant leur utilisation. Ne tentez jamais de démonter une batterie, de la modifier de quelque façon que ce soit, en la soudant etc.
- Si du liquide de batterie atteint vos yeux, rincez-les immédiatement à l'eau courante claire et froide et consultez un médecin immédiatement.
- Stockez toujours les batteries hors de la portée des petits enfants. Si un enfant avale accidentellement une batterie, consultez immédiatement un médecin.

 **AVERTISSEMENT**

- Conservez les batteries constamment au sec
- Pour éviter des fuites, une surchauffe, un incendie ou une explosion, utilisez uniquement les batteries recommandées pour ce produit.
- Insérez la batterie soigneusement comme indiqué dans le mode d'emploi.
- Si les batteries rechargeables n'ont pas été rechargées pendant le temps indiqué, arrêtez la charge et ne les utilisez pas.
- N'utilisez pas une batterie si elle est fissurée ou cassée.
- Si une batterie fuit, se décolore ou se déforme, ou présente un quelconque caractère anormal pendant son fonctionnement, arrêtez d'utiliser l'appareil photo.
- Si du liquide de batterie se répand sur vos vêtements ou votre peau, enlevez le vêtement et lavez immédiatement la zone touchée à l'eau courante froide. Si le fluide vous brûle la peau, consultez immédiatement un médecin.
- Ne soumettez jamais les batteries à des chocs violents ou des vibrations continues.



ATTENTION

- Avant de l'insérer, inspectez toujours soigneusement la batterie, vérifiez qu'il n'y a pas de fuites, de décoloration, de déformation ou tout autre anomalie.
- La batterie peut chauffer si elle est utilisée de manière prolongée. Pour éviter les brûlures légères, ne la retirez pas immédiatement après l'avoir utilisée.
- Retirez toujours la batterie de l'appareil avant de le ranger pour une longue durée.

Pour les utilisateurs d'Amérique du Nord et du Sud

Pour les utilisateurs aux États-Unis

Déclaration de conformité

Numéro du modèle : FE-200

Nom de marque : OLYMPUS

Partie responsable : **OLYMPUS IMAGING AMERICA INC.**

Adresse : 3500 Corporate Parkway, P.O. Box 610, Center Valley, PA
18034-0610, U.S.A.

Numéro de téléphone : 484-896-5000

Déclaré conforme aux normes FCC

POUR UNE UTILISATION AU BUREAU OU A DOMICILE

Cet appareil est conforme à la section 15 de la réglementation FCC. Le fonctionnement est soumis aux deux conditions suivantes:

- (1) Cet appareil ne peut générer d'interférences nuisibles.
- (2) Cet appareil doit accepter toutes les interférences reçues, les interférences pouvant occasionner un fonctionnement non souhaité incluses.

Pour les utilisateurs au Canada

Cet appareil numérique de classe B répond à toutes les exigences des réglementations canadiennes relatives aux équipements générant des interférences.

Fr

Marques déposées

- IBM est une marque déposée de la société International Business Machines Corporation.
- Microsoft et Windows sont des marques déposées de la société Microsoft Corporation.
- Macintosh est une marque de Apple Computer Inc.
- xD-Picture Card™ est une marque déposée.
- Tous les autres noms de sociétés et appellations de produits sont des marques, déposées ou non, des propriétaires respectifs.
- Les normes pour les systèmes de fichiers d'appareil photo indiquées dans ce manuel sont les normes "Design Rule for Camera File System/DCF" stipulées par l'association JEITA (Japan Electronics and Information Technology Industries Association).

Memo

Tabla de contenidos

Reúna estos componentes (contenido de la caja)	55
Prepare la batería	56
Encendido	57
Ajuste de la fecha y hora	58
Seleccionar un idioma	60
Disparar	61
Ver las fotografías	62
Utilización básica	63
Botones del modo de fotografía	63
Disco de modo	64
Modos de SCENE (Escenas)	64
Modo macro	65
Modos de flash	65
Obturador automático	66
Función de ahorro de energía	66
Menús y ajustes	67
Menú superior	67
Borrar todas las fotografías	67
Conexión de la cámara	68
Reproducción en un televisor	68
Impresión directa (PictBridge)	69
Transferencia de imágenes	70
Software OLYMPUS Master	72
Especificaciones	73
Precauciones de seguridad	75
● Antes de utilizar la cámara, lea atentamente este manual para poder utilizarla correctamente.	
● Antes de tomar fotografías importantes, le recomendamos que realice varias tomas de prueba para familiarizarse con el uso de su cámara.	
● Le rogamos observe todas las precauciones de seguridad que figuran al final de este manual.	
● Las imágenes de la pantalla LCD y las ilustraciones de la cámara que se usan en este manual pueden diferir del producto real.	

Reúna estos componentes (contenido de la caja)



Cámara digital



Correa



Batería de iones de litio LI-12B

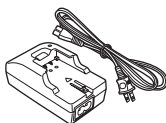

Cargador de batería
LI-10C



Cable USB

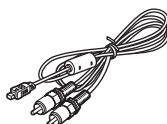

Cable AV



OLYMPUS Master
CD-ROM

Otros artículos

- Manual básico (este manual)
- Manual avanzado
- Tarjeta de garantía

Los contenidos pueden variar dependiendo del lugar de compra.

Colocación de la correa

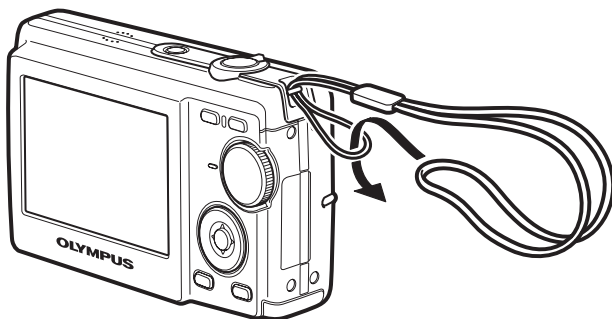

- Tire de la correa para que quede apretada y no se suelte.

Es

Prepare la batería

a. Cargue la batería.

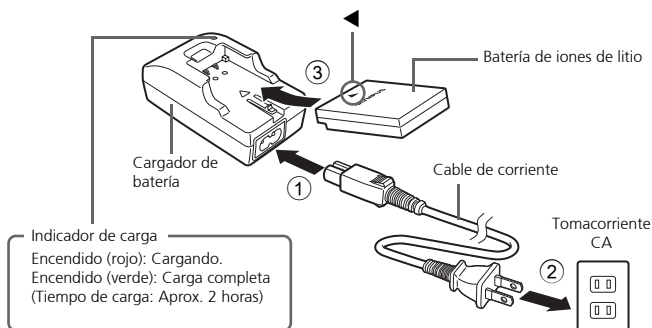

- La batería viene cargada parcialmente.

Es

b. Inserte las pilas en la cámara

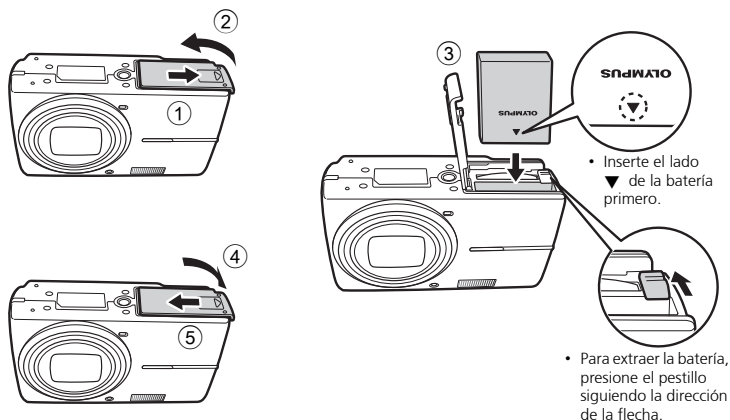

- Para obtener más información sobre cómo insertar la tarjeta xD-Picture Card opcional (en lo sucesivo denominada la tarjeta), consulte el Manual avanzado.

Encendido

En esta sección se explica cómo encender la cámara en modo de fotografía.

a. Sitúe el disco de modo en **AUTO**

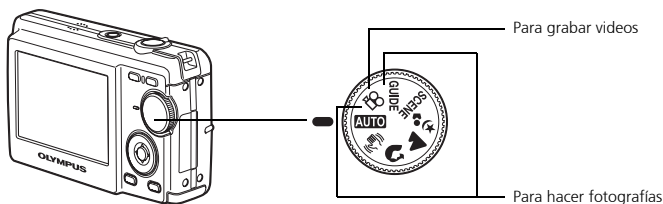

Modos de toma de fotografías

AUTO	La cámara realiza los ajustes óptimos y toma la fotografía.
	Esta función reduce el efecto borroso que produce el movimiento del sujeto o la cámara al tomar fotografías.
	Adecuado para fotografiar personas.
	Apropiado para fotografiar paisajes.
	Adecuado para fotografiar personas por la noche.
SCENE	Tome fotografías mediante la selección de un modo de escena según la situación.
GUIDE	Puede ajustar las opciones que desee configurándolas según la guía de fotografía que aparece en la pantalla.

b. Presione el botón **POWER**

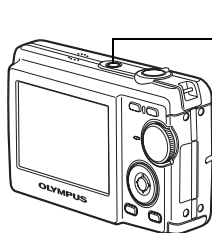

Esta pantalla aparece si no se ha ajustado la fecha y la hora.

- Para apagar la cámara, presione el botón **POWER** de nuevo.

Es

Ajuste de la fecha y hora

Acerca de la pantalla de ajuste de la fecha y hora

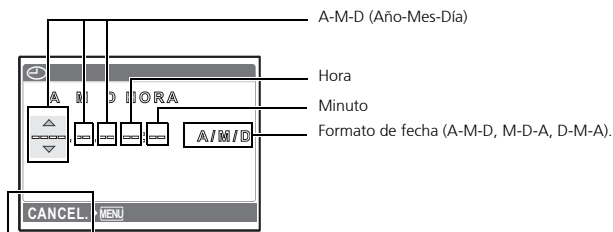

Para cancelar el ajuste

a. Presione los botones Δ \square y ∇ \odot para seleccionar [A].

- Los dos primeros dígitos del año son fijos.

Es

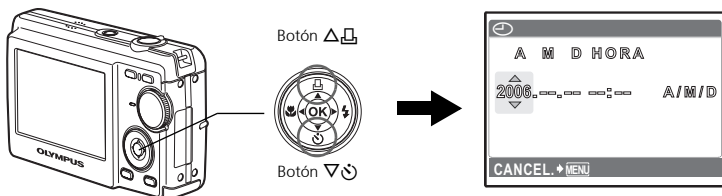

b. Presione el botón \triangleright ⚡ .

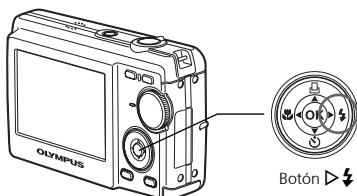

c. Presione los botones Δ \square y ∇ \odot para seleccionar [M].



d. Presione el botón .

e. Presione los botones   y  para seleccionar [D].



f. Presione el botón .

g. Presione los botones   y  para seleccionar "hora" y "minuto".



h. Presione el botón .

i. Presione los botones   y  para seleccionar el año, el mes y la fecha.

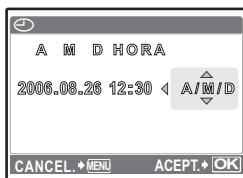

j. Una vez ajustadas todas las opciones, presione .

- La hora se muestra en el formato de 24 horas.
- Para un ajuste más preciso, puede presionar  cuando el reloj marque 00 segundos.

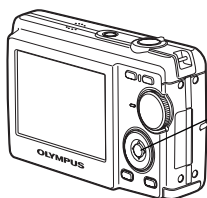

Botón 



Es

Seleccionar un idioma

- a. Presione el botón MENU para ver el menú superior.

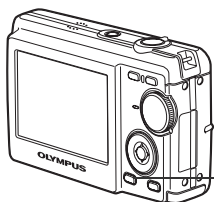

Botón MENU

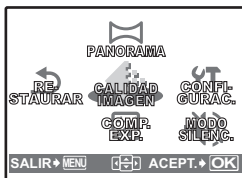



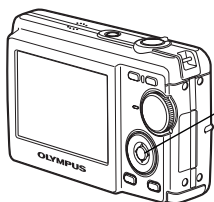



- b. Presione el botón  para seleccionar [CONFIGURAC.] y luego presione el botón .



Botón 



- c. Presione el botón  para seleccionar  y luego presione el botón .

- d. Presione los botones  y  para seleccionar un idioma y luego presione el botón .

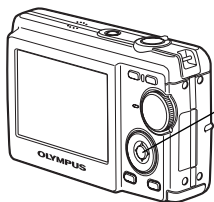

Botón 



Botón 

Botón 

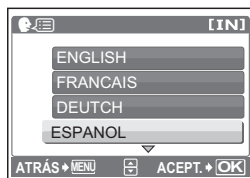

- Se pueden añadir otros idiomas a la cámara con el software OLYMPUS Master suministrado. Consulte el Manual avanzado.

Disparar

a. Sujete la cámara

Sujeción horizontal

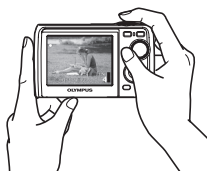
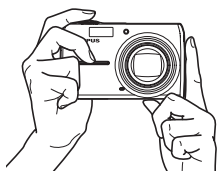

Sujeción vertical



b. Enfoque

Coloque esta marca sobre el sujeto.

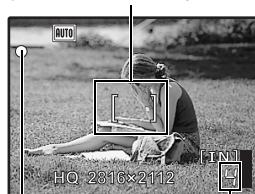
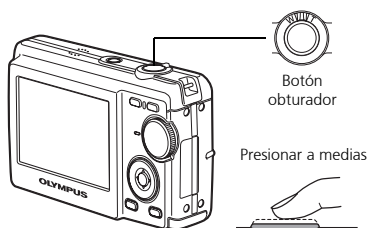

Aparecerá el número de fotografías que puede almacenar.

El piloto verde indica que el enfoque y la exposición están bloqueados.

c. Dispare

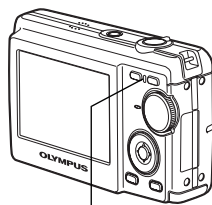
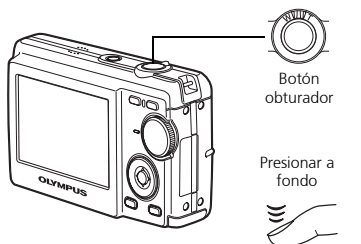

El piloto de control de la tarjeta parpadea.

Es

Ver las fotografías

a. Presione el botón .

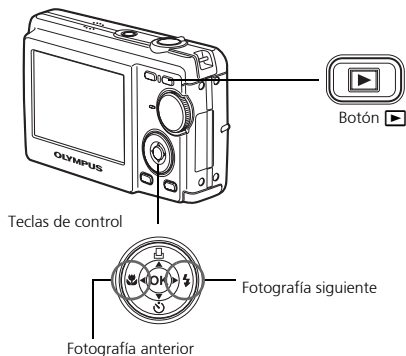

Es

Borrar las imágenes

a. Como se explica en el punto a. anterior, visualice la fotografía que desea borrar.

b. Presione el botón .

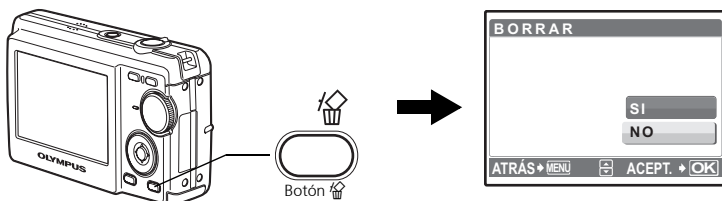

c. Presione el botón  para seleccionar [SI] y luego presione .

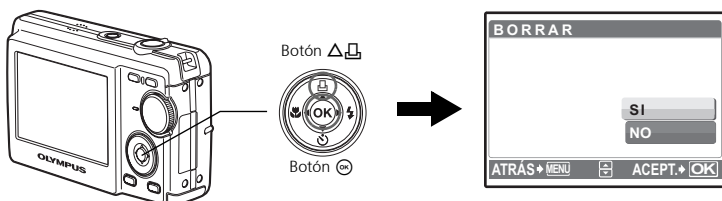

Botones del modo de fotografía

En el modo de fotografía, puede usar estos botones para acceder rápidamente a las funciones más habituales.

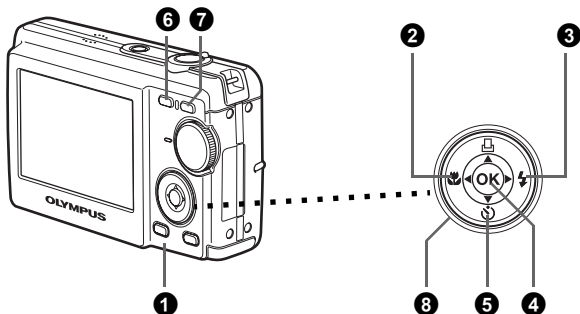

- 1 Botón MENU**
Muestra el menú superior en el monitor
- 2 Botón (modo macro)**
Utilice el modo macro o supermacro cuando tome fotografías de primeros planos, por ejemplo, de una flor.
- 3 Botón (modo de flash)**
Seleccione uno de los 4 modos de flash: Automático, Reducción de ojos rojos, Flash de relleno o bien Flash desactivado.
- 4 Botón (confirmación)**
Presione para confirmar los ajustes.
- 5 Botón (Obturador automático)**
Seleccione el obturador automático para retrasar la toma 12 segundos aproximadamente desde el momento de presionar el botón obturador.
- 6 Botón (fotografía)**
Selecciona el modo de fotografía.
- 7 Botón (reproducción)**
Selecciona el modo de reproducción.
- 8 Teclas de control ()**
Selecciona escenas, reproduce fotografías y selecciona opciones de menú.

Disco de modo

Seleccione el modo deseado y encienda la cámara. Los modos se pueden seleccionar antes de encender la cámara o durante su uso.

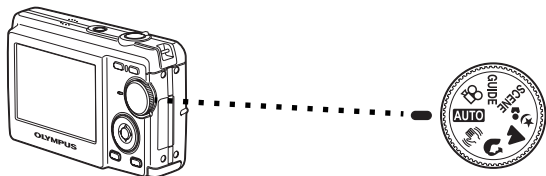

AUTO	Adecuado para hacer fotografías habituales.
	Esta función reduce la posibilidad de que las fotografías salgan borrosas debido al movimiento del sujeto o de la cámara.
	Adecuado para hacer fotografías de retratos.
	Adecuada para fotografiar paisajes y otras escenas exteriores.
	Adecuado para hacer fotografías del sujeto contra un fondo distante.
SCENE	Esta función le permite seleccionar entre 10 modos de situación configurados según las condiciones de fotografía.
	Esta función le permite filmar vídeos.
GUIDE	Puede ajustar el ajuste deseado siguiendo la guía de fotografía que aparece en el monitor.

Es

Modos de SCENE (Escenas)





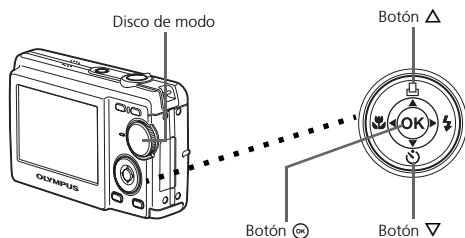

Elija el modo de fotografía según un objeto.

- 1 Sitúe el disco de modo en **SCENE** y seleccione la otra escena.











- 2 Presione Δ/∇ para seleccionar los modos de escenas y luego presione \ominus .





Modos de ESCENA para fotografía



-  DEPORTE
-  INTERIORES
-  VELAS
-  AUTO - RETRATO
-  PUESTA SOL
-  FUEG. ARTIF.
-  VITRINA
-  COCINA
-  DOCUMENTOS
-  SUBASTA

Modo macro

-  Este modo le permite fotografiar a una distancia de 20 cm del sujeto. (Lado de gran angular máximo)
 -  Utilice este modo para tomar fotografías a una distancia de 5 cm del sujeto. En el modo  , la posición del objetivo zoom está fijada.
- 1 Presione   varias veces para seleccionar [] o [] y presione .

Modos de flash

- 1 Presione   varias veces para seleccionar el modo de flash y luego presione .
- 2 Presione a medias el botón obturador.
 - Si el flash está ajustado para dispararse, se ilumina la marca .
- 3 Presione el botón obturador a fondo para tomar la fotografía.

Icono	Modo de flash	Descripción
AUTO	Flash automático	El flash se dispara automáticamente en condiciones de baja iluminación o de contraluz.
	Flash con reducción de ojos rojos	El modo de flash con reducción de ojos rojos reduce significativamente este fenómeno emitiendo destellos previos antes de dispararse el flash normal.
	Flash de relleno	El flash se dispara independientemente de la luz disponible.
	Flash desactivado	El flash no se dispara, aun en condiciones de baja iluminación.

Es

Obturador automático

- 1 Presione ∇ \odot para seleccionar \odot y luego presione \odot .
- 2 Presione el botón obturador a fondo para tomar la fotografía.
 - El LED del obturador automático se ilumina durante unos 10 segundos después de presionar el botón obturador, luego empieza a parpadear. Tras parpadear durante 2 segundos aproximadamente, se toma la fotografía.



Función de ahorro de energía

- Para ahorrar energía, la cámara entra automáticamente en el modo de reposo y deja de funcionar si no se utiliza durante 3 minutos. Presione el botón obturador o la palanca de zoom para reactivar la cámara.
- Si la cámara no se utiliza durante 15 minutos después de entrar en el modo de reposo, se retrae automáticamente el objetivo y se apaga. Para volver a utilizarla, enciéndala otra vez.

Es

Menús y ajustes

Menú superior

- 1 Presione **MENU** para abrir el menú superior.

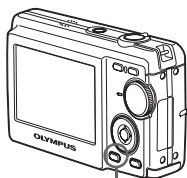

Menú superior en modo de fotografía



- 2 Utilice las teclas de control (Δ / ∇ / \leftarrow / \rightarrow) para seleccionar opciones de menú, y presione \odot para ajustarlas.

PANORAMA

Le permite crear fotografías panorámicas mediante el software OLYMPUS Master del CD-ROM suministrado. Para tomar fotografías panorámicas hace falta una tarjeta Olympus xD-Picture Card.

RESTAURAR

Restaura los valores de los ajustes de fábrica.

CALIDAD IMAGEN

Ajuste la calidad de la imagen que va a capturar según la finalidad de la fotografía.

CONFIGURAC.

Ajuste la fecha y la hora, el idioma, el sonido de funcionamiento, etc.

COMP. EXP. (Compensación de la exposición)

Utilice este ajuste para aumentar (+) o reducir (-) la exposición de una fotografía.

MODO SILENC.

Silencia los sonidos de funcionamiento que se producen durante las operaciones de fotografía y reproducción.

Es

Borrar todas las fotografías

- 1 Presione **MENU** en modo de reproducción para ver el menú superior y seleccione [BORRAR] > [BORRAR TODO].
- 2 Seleccione [SI] y presione \odot .
 - Se borran todas las fotografías.

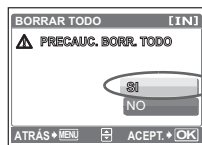





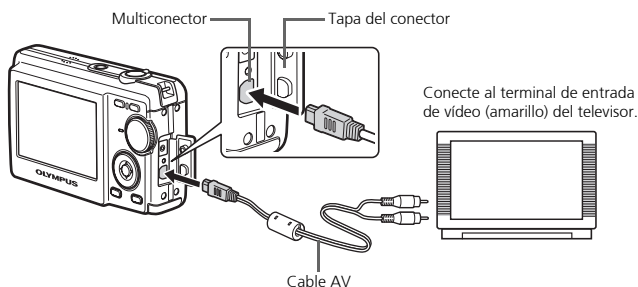

Conexión de la cámara

Reproducción en un televisor

Emplee el cable de vídeo suministrado con la cámara para reproducir imágenes grabadas en el televisor. Puede reproducir tanto fotografías como vídeos.

- 1 Compruebe que el televisor y la cámara estén apagados. Conecte el multiconector de la cámara al terminal de entrada de vídeo del televisor usando el cable AV.



- 2 Encienda el televisor y cambie al modo de entrada de vídeo.
 - Para obtener más información sobre la manera de cambiar la entrada de vídeo, consulte el manual de instrucciones del televisor.
- 3 Encienda la cámara y presione  para entrar en el modo de reproducción.
 - En el televisor aparecerá la última fotografía tomada. Utilice las flechas de control (///) para seleccionar la fotografía que desea ver.

Es

Impresión directa (PictBridge)

Usando el cable USB suministrado, puede conectar la cámara a una impresora compatible con PictBridge, como la Olympus P-11, para imprimir fotografías. Puede imprimir una fotografía mediante operaciones sencillas.

- 1 En el modo de reproducción, localice en el monitor la fotografía que desea imprimir.
- 2 Conecte un extremo del cable USB suministrado al multiconector de la cámara y el otro extremo al conector USB de la impresora.

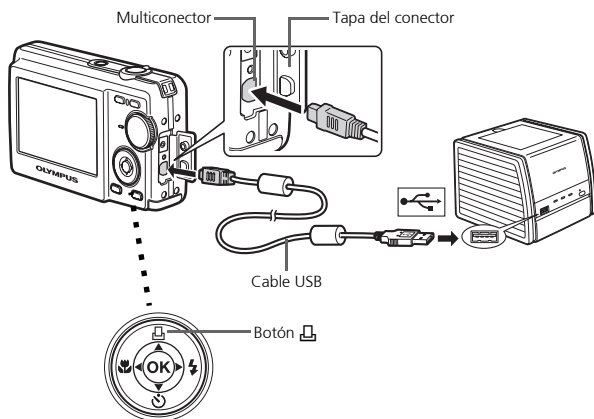

- 3 Presione .

 - Se inicia la impresión.
 - Cuando haya terminado, desconecte el cable USB de la cámara con la pantalla de selección de fotografías activa.



Es

Transferencia de imágenes

Instalar el software

- 1 Inserte el CD-ROM de OLYMPUS Master.
- 2 **Windows:** Haga clic en el botón "OLYMPUS Master".
Macintosh: Haga doble clic en el icono "Installer".
- 3 Siga las instrucciones en pantalla.



Conecte la cámara a un ordenador

- 1 Conecte la cámara y el ordenador usando el cable USB (incluido).
 - El monitor se encenderá automáticamente.

Es

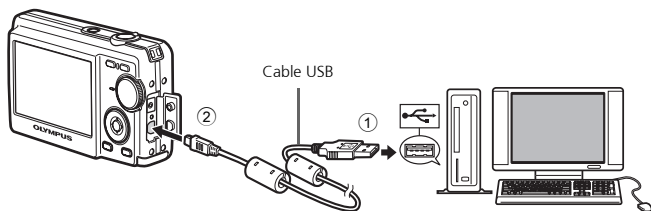

- 2 Seleccione [PC] en el monitor y presione **OK**.

- Ahora el ordenador reconocerá su cámara como una unidad de almacenamiento extraíble.

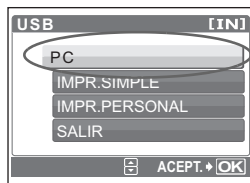

Transfiera las imágenes al ordenador

- 1 Ahora, con la cámara conectada, abra el programa OLYMPUS Master.
 - Aparece la ventana [Transferir imágenes].
- 2 Seleccione las imágenes que desea transferir y haga clic en el botón [Transferir imágenes].

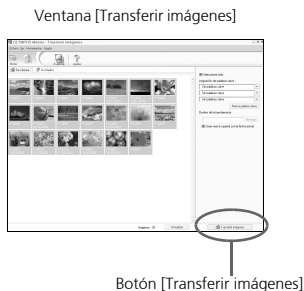

Si no aparece automáticamente la ventana [Transferir imágenes]:

- a. Haga clic en el icono "Transferencia de imágenes" en el menú principal de OLYMPUS Master.
- b. Haga clic en el icono "Desde cámara".

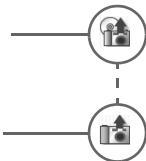

Es

Consejos

- Para obtener información más detallada acerca de la configuración y el uso de la cámara, consulte el "Manual Avanzado" de la cámara que se incluye en el CD-ROM.
- Para más información sobre el uso del software OLYMPUS Master, consulte el manual (electrónico) de referencia instalado en la carpeta OLYMPUS Master de su disco duro. Si necesita ayuda adicional, consulte el archivo "Ayuda" del software OLYMPUS Master.

Software OLYMPUS Master

Software OLYMPUS Master: ¡Utilice este software para descargar fotografías desde la cámara, ver, organizar, retocar, imprimir y mandar por correo electrónico e imprimir sus fotos digitales, vídeos y mucho más! Este CD también contiene el manual de referencia del software completo en formato Adobe Acrobat (PDF).



● Requisitos del sistema

SO	Windows 98SE/Me/2000 Professional/XP o Mac OS X (10.2 o posterior)
CPU	Pentium III 500 MHz/Power PC G3, o superior
RAM	128 MB o más (se recomienda 256 MB o más)
Disco duro	300 MB de espacio libre o más
Conexión	Puerto USB
Monitor	1024 x 768 píxeles de resolución o más con un mínimo de 65.536 colores (Windows), 32.000 colores (Macintosh)

Es

Para obtener la información de asistencia más actualizada, visite el sitio Web de Olympus (<http://www.olympus.com/digital>)

● Actualización (OLYMPUS Master Plus)

Además de las funciones de OLYMPUS Master, la versión OLYMPUS Master Plus incluye funciones como la edición de vídeo, impresión de álbumes, impresión de hojas de contactos, álbum HTML, panorama de pegado libre, escritura en CD/DVD y mucho más, permitiéndole ampliar considerablemente sus posibilidades en fotografía digital.

Puede actualizar su software a la versión OLYMPUS Master Plus a través de Internet. Es necesario tener instalado OLYMPUS Master en un ordenador con conexión a Internet.



Registro de usuario

Registre su cámara cuando instale OLYMPUS Master para activar su garantía, recibir notificaciones sobre actualizaciones de software y firmware de la cámara, y mucho más.

● Cámara

Tipo de producto	: Cámara digital (para fotografía y reproducción)
Sistema de grabación	
Fotografías	: Grabación digital, JPEG (compatible con DCF)
Estándares aplicables	: Exif 2.2, DPOF, PRINT Image Matching III, PictBridge
Vídeo	: Compatible con QuickTime Motion JPEG
Memoria	: Memoria interna xD-Picture Card (16 MB - 1 GB)
Núm. de píxeles efectivos	: 6.000.000 píxeles
Dispositivo de captura de imagen	: 1/2,5" CCD (filtro de colores primarios), 6.400.000 píxeles (en total)
Objetivo	: Objetivo Olympus de 4,6 a 23 mm, de F3,3 a 4,8 (equivalente a un objetivo de 28 a 140 mm en una película de 35 mm)
Sistema fotométrico	: Medición ESP digital
Velocidad de obturación	: 4 a 1/2000 seg.
Alcance de fotografía	: 0,2 m a ∞ (W) 0,5 m a ∞ (T) (normal/modo macro) 0,05 m a 0,2 m (sólo W) (modo súper macro)
Monitor:	: Pantalla LCD TFT en color de 2,5", 153.600 píxeles
Conector exterior	: Jack DC-IN, conector USB/Jack salida AV (multiconector)
Sistema de calendario automático	: Actualización automática desde 2000 a 2099
Entorno de funcionamiento	
Temperatura	: 0 a 40°C (funcionamiento)/-20 a 60°C (almacenamiento)
Humedad	: 30 a 90 % (funcionamiento)/10 a 90 % (almacenamiento)
Fuente de alimentación	: Una batería de iones de litio Olympus (LI-12B/L1-10B especificada por Olympus) o el adaptador de CA especificado por Olympus
Dimensiones	: 97,5 mm (An) × 59 mm (Al) × 27 mm (Pr) (sin salientes)
Peso	: 155 g (sin batería ni tarjeta)

● **Batería de iones de litio (LI-12B)**

Tipo de producto	: Batería recargable de iones de litio
Voltaje estándar	: CC 3,7 V
Capacidad estándar	: 1.230 mAh
Duración de la batería	: Aprox. 300 recargas completas (varía según el uso)
Entorno de funcionamiento	
Temperatura	: 0°C a 40°C (carga)/ -10°C a 60°C (funcionamiento)/ 0°C a 30°C (almacenamiento)
Dimensiones	: 32 × 46 × 10 mm
Peso	: Aprox. 30 g

● **Cargador de batería (LI-10C)**

Requisitos de potencia	: CA de 100 a 240 V (50 a 60 Hz) 11 VA (100 V) a 17 VA (240 V)
Salida	: CC 4,2 V, 860 mA
Tiempo de carga	: Aprox. 120 min.
Entorno de funcionamiento	
Temperatura	: 0°C a 40°C (funcionamiento)/ -20°C a 60°C (almacenamiento)
Dimensiones	: 46 × 36.5 × 80 mm
Peso	: Aprox. 70 g

Es

El diseño y las especificaciones están sujetos a cambios sin previo aviso.

Precauciones de seguridad



PRECAUCIÓN

RIESGO DE DESCARGAS
ELÉCTRICAS
NO ABRIR



PRECAUCIÓN: PARA REDUCIR EL RIESGO DE DESCARGAS ELÉCTRICAS, NO RETIRE LA CUBIERTA (O PARTE TRASERA). EN EL INTERIOR NO HAY PIEZAS QUE EL USUARIO PUEDA REPARAR. REMITA LA REPARACIÓN A PERSONAL DE SERVICIO ESPECIALIZADO OLYMPUS.



El signo de admiración dentro de un triángulo equilátero tiene como finalidad alertar al usuario de la existencia de importantes instrucciones de operación y mantenimiento en la documentación suministrada con el producto.



PELIGRO

Si el producto es utilizado sin observar la información representada bajo este símbolo, podría causar serias lesiones o muerte.



ADVERTENCIA

Si el producto es utilizado sin observar la información representada bajo este símbolo, podría causar serias lesiones o muerte.



PRECAUCIÓN

Si el producto es utilizado sin observar la información representada bajo este símbolo, podría causar lesiones personales menores, daños al equipo, o pérdida de datos importantes.

¡ADVERTENCIA!

PARA EVITAR EL RIESGO DE INCENDIO O DESCARGAS ELÉCTRICAS, NUNCA DESMONTE NI EXPONGA ESTE PRODUCTO AL AGUA NI LO UTILICE EN UN ENTORNO MUY HÚMEDO.

Es

Precauciones Generales

Lea todas las instrucciones — Antes de utilizar este producto, lea todas las instrucciones operativas. Guarde todos los manuales y la documentación para futuras consultas.

Limpieza — Siempre desenchufe el producto de la toma de corriente antes de limpiarlo. Para la limpieza use sólo un paño húmedo. Nunca use limpiadores líquidos o aerosoles, ni solventes orgánicos de ningún tipo para limpiar este producto.

Accesorios — Para su seguridad y evitar daños al producto, utilice únicamente los accesorios recomendados por Olympus.

Agua y humedad — En las precauciones de los productos diseñados a prueba de la intemperie, consulte las secciones de resistencia a la intemperie en sus respectivos manuales.

Ubicación — Para evitarle daños al producto, monte el producto sobre un trípode, caballete o soporte estable.

Fuentes de alimentación — Conecte este producto únicamente con la fuente de alimentación descrita en la etiqueta del producto.

Rayos — Si se produce una tormenta eléctrica mientras está utilizando el adaptador de CA, retírelo de la toma de corriente inmediatamente.

Objetos extraños — Para evitar daños personales, nunca inserte objetos de metal en el producto.

Calentadores — Nunca utilice ni guarde este producto cerca de fuentes de calor, tales como radiadores, rejillas de calefacción, estufas o cualquier tipo de equipo o aparato generador de calor, incluyendo amplificadores estéreo.

Manejo de la cámara



ADVERTENCIA

- **No utilice la cámara cerca de gases inflamables o explosivos.**
- **No utilice el flash a corta distancia de las personas (especialmente niños menores y mayores, etc.).**
 - Cuando dispare el flash, deberá mantener, por lo menos, una distancia de 1 m de la cara de los sujetos. El disparo demasiado cercano de los ojos del sujeto podrá causarle la pérdida de visión momentánea.
- **Mantenga a los niños menores y mayores alejados de la cámara.**
 - Utilice y guarde siempre la cámara fuera del alcance de los niños menores y mayores, para prevenir las siguientes situaciones de peligro que podrían causarles serias lesiones:
 - Enredarse con la correa de la cámara, ocasionando asfixia.
 - Ingerir accidentalmente una batería, tarjetas, u otras piezas pequeñas.
 - Disparar el flash accidentalmente hacia sus propios ojos o hacia los ojos de otro niño.
 - Lesionarse accidentalmente con las piezas móviles de la cámara.
- **No mire al sol ni a luces fuertes a través de la cámara.**
- **No utilice ni guarde la cámara en lugares polvorientos o húmedos.**
- **No cubra el flash con la mano mientras efectúa el disparo.**

Es



PRECAUCIÓN

- **Interrumpa inmediatamente el uso de la cámara si percibe algún olor, ruido o humo extraño alrededor de la misma.**
 - Nunca retire las baterías con las manos descubiertas, ya que podría causar un incendio o quemarle las manos.
- **Nunca sujete ni utilice la cámara con las manos mojadas.**
- **No deje la cámara en lugares donde pueda estar sujeta a temperaturas extremadamente altas.**
 - Si lo hace puede provocar el deterioro de las piezas y, en algunas circunstancias, provocar que se prenda fuego. No utilice el cargador o el adaptador CA si está cubierto (por ejemplo con una frazada). Esto podría causar recalentamiento, resultando en incendio.
- **Manipule la cámara con cuidado para evitar una quemadura de leve.**
 - Ya que la cámara contiene partes metálicas, el recalentamiento puede resultar en una quemadura de baja temperatura. Preste atención a lo siguiente:
 - Cuando utilice la cámara durante un largo período, ésta se recalentará. Si mantiene la cámara en este estado, podría causar una quemadura de baja temperatura.
 - En lugares sujetos a temperaturas extremadamente bajas, la temperatura de la carcasa de la cámara puede ser más baja que la temperatura ambiente. Si es posible, póngase guantes cuando manipule la cámara en temperaturas bajas.
- **Tenga cuidado con la correa.**
 - Tenga cuidado con la correa cuando transporte la cámara. Podría engancharse en objetos sueltos y provocar daños graves.

Precauciones acerca del uso de la batería

Siga estas importantes indicaciones para evitar que se produzcan fugas, recalentamientos, incendios o explosión de la batería, o que cause descargas eléctricas o quemaduras.

PELIGRO

- La cámara utiliza una batería de iones de litio especificada por Olympus. Cargue la batería con el cargador especificado. No utilice otros cargadores.
- Nunca caliente ni incinere las baterías.
- Tome precauciones al transportar o guardar las baterías a fin de evitar que entren en contacto con objetos metálicos, tales como alfileres, horquillas, cierres, etc.
- Nunca guarde las baterías en lugares donde queden expuestas a la luz solar directa o sujetas a altas temperaturas en el interior de un vehículo con calefacción, cerca de fuentes de calor, etc.
- Para evitar que ocurran fugas de líquido de las baterías o daños de sus terminales, siga cuidadosamente todas las instrucciones respectivas al uso de las baterías. Nunca intente desarmar una batería ni modificarla de ninguna manera, por soldadura, etc.
- Si el fluido de la batería penetra en sus ojos, lávelos de inmediato con agua corriente fresca y limpia, y solicite atención médica inmediatamente.
- Siempre guarde las baterías fuera del alcance de los niños pequeños. Si un niño ingiere una batería accidentalmente, solicite atención médica inmediatamente.

ADVERTENCIA

- Conserve la batería siempre seca.
- Para evitar que ocurran fugas de líquido, recalentamiento de la batería, o que cause incendio o explosión, utilice únicamente la batería recomendada para el uso con este producto.
- Inserte la batería cuidadosamente, tal como se describe en el manual de instrucciones.
- Si las baterías recargables no han sido recargadas dentro del tiempo especificado, interrumpa la carga y no las utilice.
- No utilice una batería si está rajada o quebrada.
- Si se producen fugas de líquido, decoloración o deformación de la batería, o cualquier otra anomalía durante la operación, interrumpa el uso de la cámara.
- Si el fluido de la pila entra en contacto con su ropa o con su piel, quítese la ropa y lave de inmediato la parte afectada con agua corriente fresca y limpia. Si el fluido quemara su piel, solicite atención médica inmediatamente.
- Nunca exponga la batería a fuertes impactos ni a vibraciones continuas.

Es



PRECAUCIÓN

- Antes de colocarla, siempre inspeccione la batería atentamente para verificar si no ocurre fugas de líquido, decoloración, deformación o cualquier otra anomalía.
- La batería puede recalentarse durante el uso prolongado. Para evitar quemaduras menores, no la retire inmediatamente después de utilizar la cámara.
- Siempre retire la batería de la cámara antes de guardar la cámara por un largo tiempo.

Para los clientes de Norte y Sudamérica

Para clientes de Estados Unidos

Declaración de conformidad

Número de modelo : FE-200

Marca comercial : OLYMPUS

Parte responsable : **OLYMPUS IMAGING AMERICA INC.**

Dirección : 3500 Corporate Parkway, P.O. Box 610, Center Valley,
PA 18034-0610, U.S.A.

Número de teléfono: 484-896-5000

Este equipo cumple con la normativa FCC
PARA EL USO EN EL HOGAR O LA OFICINA

Este equipo cumple con la Parte 15 de la normativa FCC. Su uso está sujeto a las dos condiciones siguientes:

- (1) Este equipo no debe causar interferencias dañinas.
- (2) Este equipo debe aceptar cualquier interferencia recibida, incluidas las interferencias que puedan causar un funcionamiento no deseado.

Para clientes de Canadá

Este equipo digital de Clase B cumple con los requisitos de la normativa canadiense sobre equipos que provocan interferencias.

Marcas comerciales

- IBM es una marca registrada de International Business Machines Corporation.
- Microsoft y Windows son marcas registradas de Microsoft Corporation.
- Macintosh es una marca comercial de Apple Computer Inc.
- xD-Picture Card™ es una marca comercial.
- Todos los demás nombres de compañías y productos son marcas registradas y/o marcas comerciales de sus respectivos propietarios.
- Las normas para sistemas de archivos de cámara referidas en este manual son las "Normas de Diseño para Sistema de Archivos de Cámara/DCF" estipuladas por la Asociación de Industrias Electrónicas y de Tecnología de Información de Japón (JEITA).

Memo

Índice

Reúna estes itens (conteúdo da caixa)	81
Prepare a bateria	82
Ligar a câmara	83
Acertar data e hora	84
Seleccionar um idioma	86
Fotografar	87
Ver as imagens	88
Funcionamento básico	89
Botões do Modo Fotografia.....	89
Selector de modo.....	90
Modos SCENE (Cena)	90
Modo Macro.....	91
Modos Flash.....	91
Temporizador.....	92
Função de poupança de energia.....	92
Menus e parâmetros	93
Menu superior	93
Apagar todas as imagens	93
Ligar a câmara	94
Reprodução num televisor.....	94
Impressão directa (PictBridge).....	95
Transferir imagens	96
Software OLYMPUS Master	98
Especificações	99
Precauções de segurança	101
● Antes de utilizar a sua câmara, leia este manual atentamente para garantir uma utilização correcta.	
● Recomendamos que tire fotografias de teste para se habituar à câmara, antes de tirar fotografias importantes.	
● Respeite as precauções de segurança apresentadas no final deste manual.	
● As imagens do ecrã LCD e as ilustrações da câmara utilizadas neste manual podem diferir do produto real.	

Reúna estes itens (conteúdo da caixa)



Câmara Digital



Correia



Bateria de íons de lítio
LI-12B

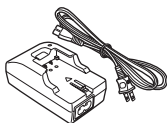

Carregador de bateria
LI-10C

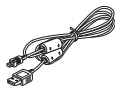

Cabo USB

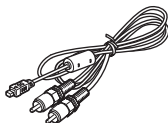

Cabo AV



CD-ROM OLYMPUS
Master

Outros itens

- Manual básico (este manual)
- Manual avançado
- Cartão de garantia

O conteúdo pode variar conforme o local de aquisição.

Po

Colocar a correia

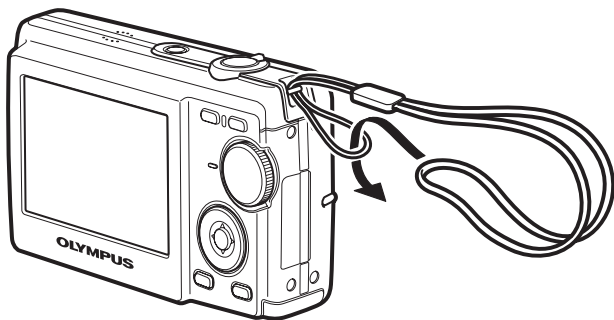

- Puxe bem a correia de modo que não fique frouxa.

Prepare a bateria

a. Carregue a bateria

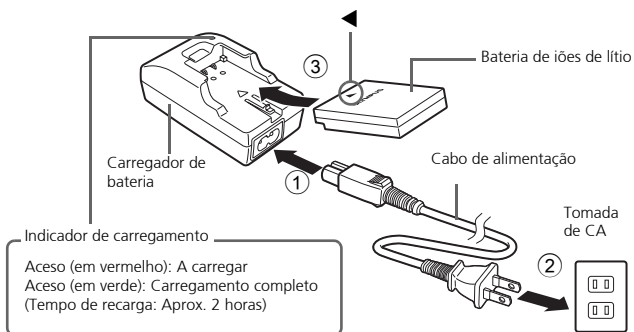

- A bateria vem parcialmente carregada.

b. Inserir a bateria na câmara

Po

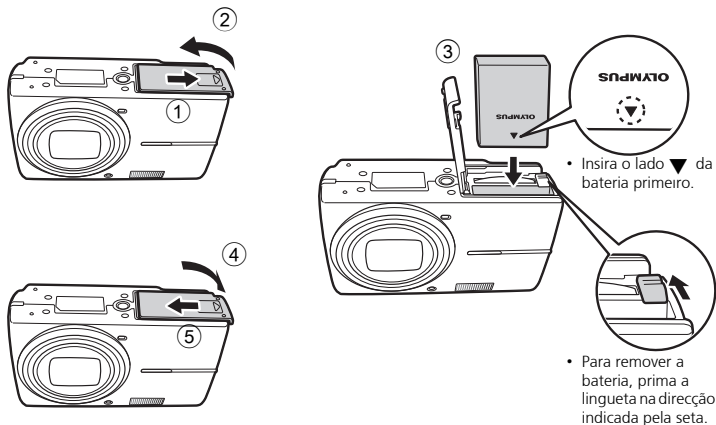

- Quanto aos detalhes sobre a inserção de um cartão xD-Picture Card (designado a partir de aqui apenas por cartão), consulte o Manual Avançado.

Ligar a câmara

Esta secção explica como ligar a câmara no modo fotografia.

a. Ajuste o selector de modo para **AUTO**

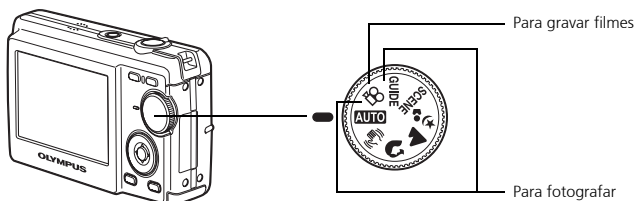

Modos de fotografia

AUTO	A câmara determina as definições óptimas e regista a imagem.
	Esta função reduz o efeito de arrastamento causado por um objecto móvel ou movimento da câmara quando fotografar imagens.
	Indicado para fotografar pessoas tipo retrato.
	Indicado para fotografar paisagens.
	Indicado para fotografar pessoas à noite.
SCENE	Seleccione um modo de cena para registar imagens de acordo com a situação.
GUIDE	É possível definir os itens desejados, mediante a definição dos parâmetros de acordo com o guia de fotografia exibido no écran.

b. Prima o botão **POWER**

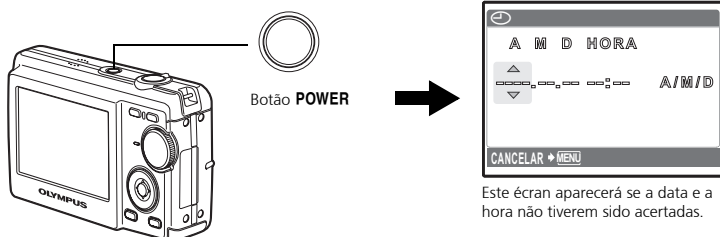

- Para desligar a câmara, prima o botão **POWER** novamente.

Acertar data e hora

Acerca do ecrã de acerto da data e da hora

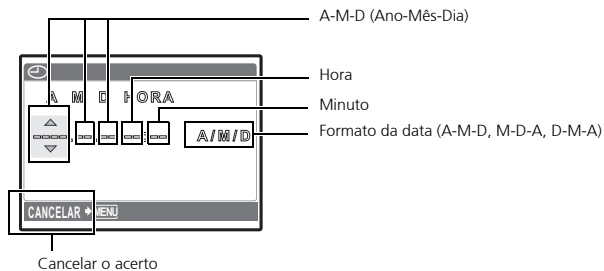

a. Prima o botão e o botão para seleccionar [A].

- Os primeiros dois dígitos do ano são fixos.

Po

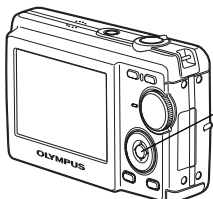

Botão



Botão





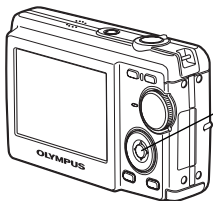



b. Prima o botão .







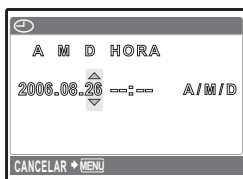

Botão

c. Prima o botão e o botão para seleccionar [M].









- d. Prima o botão  .
- e. Prima o botão   e o botão   para seleccionar [D].



- f. Prima o botão  .
- g. Prima o botão   e o botão   para seleccionar "hora" e "minuto".



- h. Prima o botão  .
- i. Prima o botão   e o botão   para seleccionar ano, mês e dia.

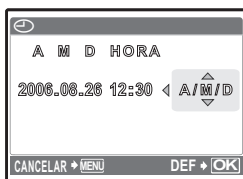

- j. Após todos os parâmetros terem sido definidos, prima .

- A hora é exibida no formato de 24 horas.
- Para uma definição mais precisa, pode-se premir  quando o sinal de hora chegar aos 00 segundos.

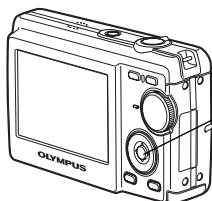

Po

Seleccionar um idioma

- a. Prima o botão MENU para exibir o menu superior.

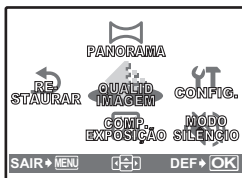
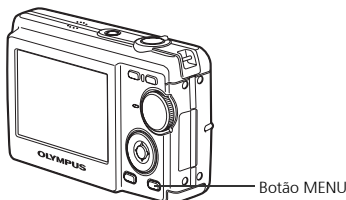

- b. Prima o botão $\triangleright \text{⚡}$ para seleccionar [CONFIG.] e então prima o botão OK .

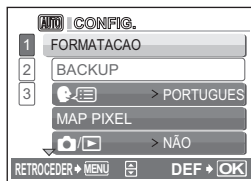
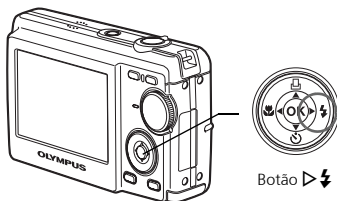

- c. Prima o botão $\nabla \text{☺}$ para seleccionar ⚡ e então prima o botão OK .
- d. Prima o botão $\nabla \text{☺}$ e o botão $\triangle \square$ para seleccionar um idioma e então prima o botão OK .

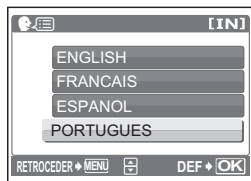
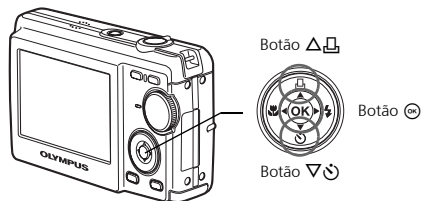

- Pode-se adicionar outros idiomas à câmara com o software OLYMPUS Master fornecido. Consulte o Manual Avançado.

Fotografar

a. Segurar a câmara

Segurar na horizontal

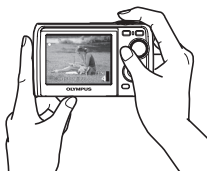
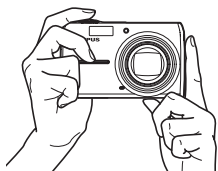

Segurar na vertical

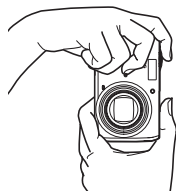

b. Focar

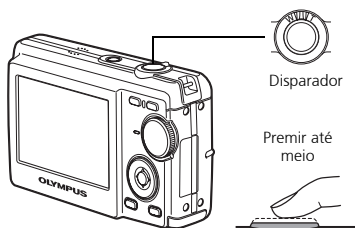

Posicione esta marca sobre o seu motivo fotográfico.



O número de fotografias que podem ser armazenadas é mostrado.

A lâmpada verde indica que o foco e a exposição estão fixos.

c. Fotografar

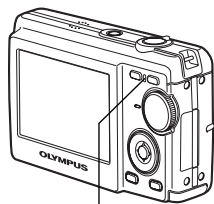
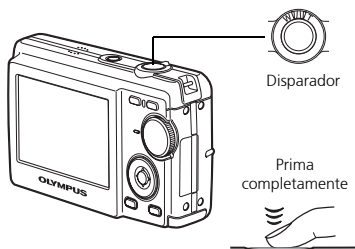

A lâmpada de acesso ao cartão pisca.

Po

Ver as imagens

a. Prima o botão .

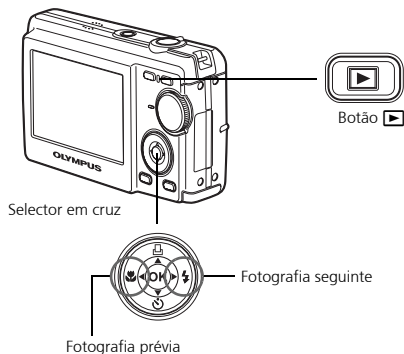

Apagar imagens

Po a. Conforme descrito acima, exiba a imagem que deseja apagar.

b. Prima o botão .

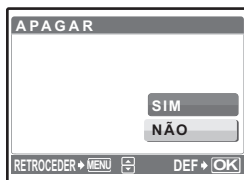
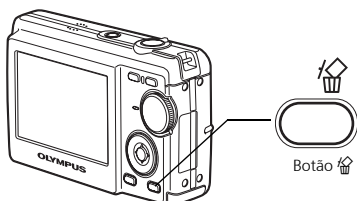

c. Prima o botão  para seleccionar [SIM] e então prima .

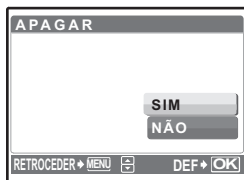
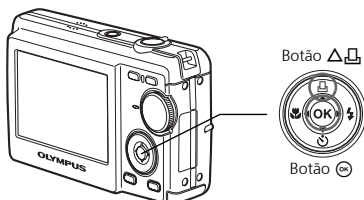

Funcionamento básico

Botões do Modo Fotografia

No Modo Fotografia, utilize estes botões para obter um acesso rápido a algumas das funções utilizadas com maior frequência.

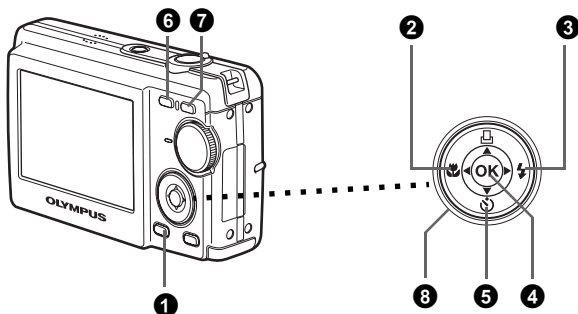

1 Botão MENU

Exibe o menu superior no monitor.

2 Botão (Modo Macro)

Utilize o modo macro ou super macro para fotografar grandes planos como, por exemplo, de uma flor.

3 Botão (Modo Flash)

Selecione entre um dos 4 modos flash - AUTO, Redução do efeito de olhos vermelhos, Flash forçado ou Flash desligado.

4 Botão (OK)

Prima para confirmar as definições.

5 Botão (Temporizador)

Selecione o temporizador para atrasar o disparo cerca de 12 segundos a partir do momento em que se pressiona o disparador.

6 Botão (Fotografar)

Selecione o modo fotografia.

7 Botão (Reprodução)

Selecione o modo reprodução.

8 Selector em cruz ()

Selecione cenas, imagens de reprodução e parâmetros do menu.

Selector de modo

Defina o modo desejado e accione a câmara. Pode-se seleccionar o modo desejado antes ou durante a utilização.

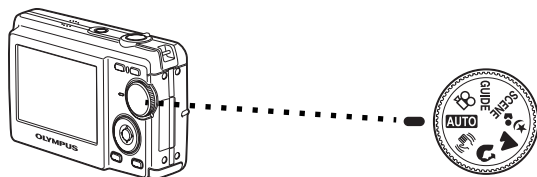

AUTO	Indicado para fotografar imagens regulares.
	Esta função reduz o efeito de arrastamento causado por um objecto móvel ou movimento da câmara quando tirar fotografias.
	Indicado para fotografar imagens tipo retrato.
	Ideal para fotografar paisagens e outras cenas exteriores.
	Indicado para fotografar o seu motivo fotográfico contra um fundo distante.
SCENE	Esta função permite-lhe seleccionar entre um dos 10 modos relacionados com 10 situações— ajustados para as condições de fotografia.
	Esta função permite-lhe gravar filmes.
GUIDE	É possível definir os parâmetros desejados seguindo o guia de fotografia exibido no monitor.

Modos SCENE (Cena)

Selecione o modo de fotografia de acordo com o motivo fotográfico.

- 1 Ajuste o selector de modo para **SCENE** e selecione uma cena diferente.

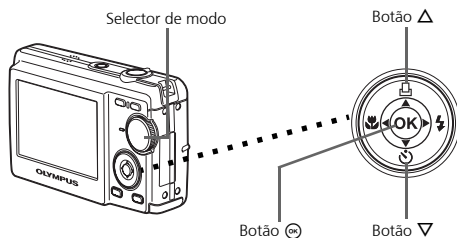

- 2 Prima Δ/∇ para seleccionar os modos de cena e prima \odot .

Modos SCENE (Cena) de fotografia

- DESPORTO
- INTERIORES
- VELA
- AUTO-RETRATO
- PÔR-DO-SOL
- FOGOS ARTIF
- ATRÁS DE VIDRO
- CULINÁRIA
- DOCUMENTOS
- MODO CENA

Modo Macro



- Este modo permite-lhe fotografar imagens a uma proximidade de até 20 cm do seu motivo fotográfico. (Lado do extremo grande angular)
 - Utilize este modo para fotografar imagens a uma proximidade de 5 cm do seu motivo fotográfico. No modo s, a posição da objectiva zoom é fixa.
- 1 Prima repetidamente para seleccionar [] ou [s] e então prima .

Modos Flash

- 1 Prima repetidamente para seleccionar o modo flash e então prima .
- 2 Prima o disparador até o meio.
 - Quando o flash for ajustado para disparar, a marca se acenderá.
- 3 Prima totalmente o disparador para fotografar.

Ícone	Modo Flash	Descrição
AUTO	Flash automático	O flash dispara automaticamente em condições de luz fraca ou contraluz.
	Flash com redução do efeito de olhos vermelhos	O modo flash de redução do efeito de olhos vermelhos reduz significativamente este fenómeno, emitindo pré-flashes antes de disparar o flash habitual.
	Flash forçado	O flash dispara independentemente da luz disponível.
	Flash desligado	O flash não dispara mesmo em situações de luz fraca.

Temporizador

- 1 Prima ∇  para seleccionar  e prima .
- 2 Prima totalmente o disparador para fotografar.
 - A luz do temporizador acende-se durante aproximadamente 10 segundos depois de o disparador ser premido e então começa a piscar. Depois de piscar durante aproximadamente 2 segundos, a imagem é fotografada.

Luz do temporizador

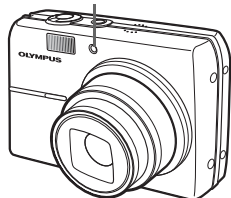

Função de poupança de energia

- Para poupar energia das pilhas, a câmara entra automaticamente em modo de repouso e deixa de funcionar se não for utilizada por aproximadamente 3 minutos. Prima o botão do obturador ou a alavanca do zoom para reactivar a câmara.
- Se a câmara não for utilizada durante 15 minutos após entrar em modo inactivo, a objectiva é recolhida e a câmara desliga-se automaticamente. Para voltar a utilizar a câmara, ligue-a novamente.

Menus e parâmetros

Menu superior

- 1 Prima **MENU** para exibir o menu superior.

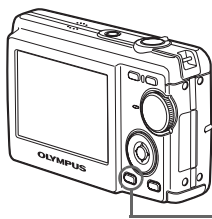

Menu superior no modo fotografia

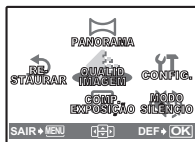

- 2 Utilize o selector em cruz ($\Delta/\nabla/\leftarrow/\rightarrow$) para seleccionar parâmetros do menu e então prima OK para defini-los.

PANORAMA

A fotografia panorâmica permite-lhe criar uma imagem panorâmica, por meio do software OLYMPUS Master do CD-ROM fornecido. Um cartão xD-Picture Card Olympus é requerida para fotografias panorâmicas.

RESTAURAR

Retorne as funções de fotografia alteradas de volta às suas predefinições de fábrica.

QUALID IMAGEM

Ajuste a qualidade da imagem que pretende fotografar de acordo com a sua finalidade.

CONFIG.

Acerte a data, a hora, o idioma, o som operativo, etc.

COMP. EXPOSIÇÃO (Compensação da exposição)

Utilize esta definição para aumentar (+) ou diminuir (-) a exposição de uma fotografia.

MODO SILÊNCIO

Desliga os sons operativos que ocorrem durante o registo fotográfico e a reprodução.

Apagar todas as imagens

- 1 Prima **MENU** no modo reprodução para exibir o menu superior e seleccionar [APAGAR] > [APAGAR IMAGS].
- 2 Selecciona [SIM] e prima OK .
 - Todas as imagens são apagadas.

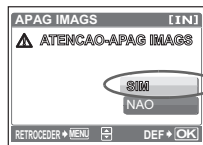

Ligar a câmara

Reprodução num televisor

Utilize o cabo de vídeo fornecido com a câmara para reproduzir imagens gravadas no seu televisor. É possível reproduzir tanto fotografias quanto filmes.

- 1 Deve certificar-se de que a TV e a câmara estão desligadas. Ligar o conector múltiplo na câmara ao terminal de entrada de vídeo na TV usando o cabo AV.

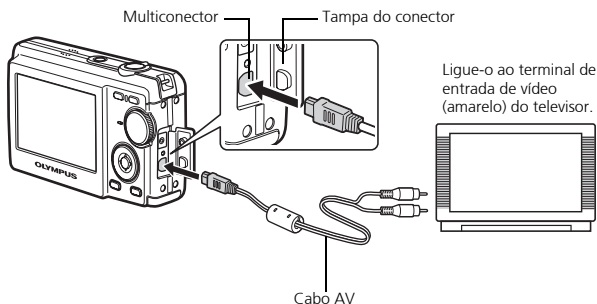

Po

- 2 Ligue o televisor e defina-o para o modo de entrada de vídeo.
 - Para obter detalhes sobre como comutar para a entrada de vídeo, consulte o manual de instruções do seu televisor.
- 3 Accione a câmara e então prima para entrar no modo reprodução.
 - A última imagem fotografada é visualizada no televisor. Utilize o selector em cruz ($\Delta/\nabla/\langle/\rangle$) para seleccionar a imagem que deseja exibir.

Impressão directa (PictBridge)

Com o cabo USB fornecido, pode ligar a sua câmara directamente a uma impressora compatível com PictBridge, como a Olympus P-11, para imprimir as fotografias. Pode-se imprimir uma fotografia com simples operações.

- 1 No modo de reprodução, exiba no monitor a imagem que deseja imprimir.
- 2 Ligar uma extremidade do cabo USB fornecido ao conector múltiplo da câmara e a outra extremidade ao conector USB da câmara.

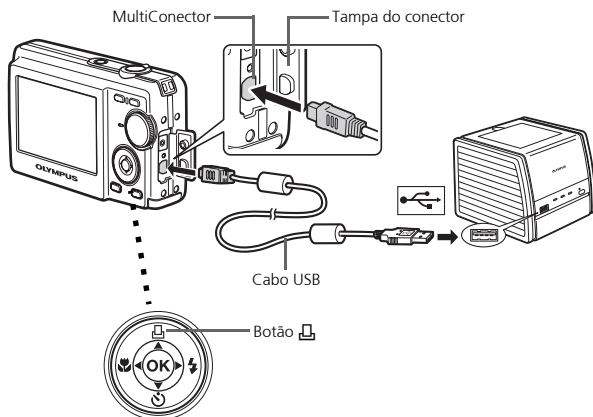

- 3 Prima .

 - A impressão começa.
 - Quando tiver terminado de imprimir, desligue o cabo USB da câmara com o ecrã de selecção de imagens exibido.



Transferir imagens

Instalar o software

- 1 Insira o CD-ROM OLYMPUS Master.
- 2 **Windows:** Faça um clique no botão "OLYMPUS Master".
Macintosh: Faça duplo clique no ícone "Instalador".
- 3 Basta seguir as instruções no ecrã.



Ligue a câmara ao computador

- 1 Ligue a câmara ao computador através do cabo USB (fornecido).
 - O ecrã ligar-se-á automaticamente.

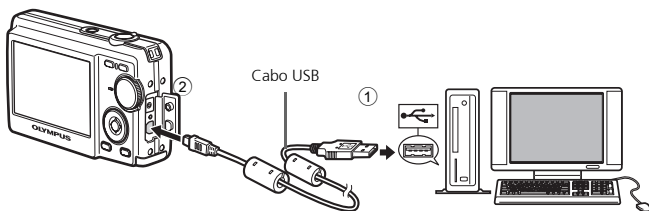

- 2 Seleccione [PC] no monitor e prima **OK**.

- O seu PC reconhecerá agora a sua câmara como uma unidade de armazenamento amovível.

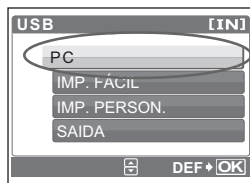

Transfira imagens para o computador

- 1 Com a câmara agora ligada, abra o OLYMPUS Master.
 - Surge a janela [Transfer Images] (Transferir imagens).
- 2 Selecciona as imagens que pretende transferir e faça um clique no botão [Transfer Images] (Transferir imagens).

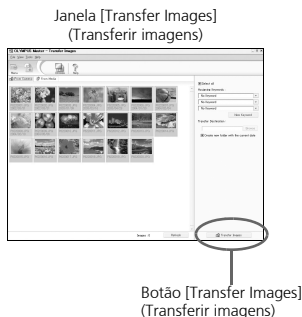

Se a janela [Transfer Images] (Transferir imagens) não surgir automaticamente:

- a. Faça um clique no ícone "Transfer Images" (Transferir imagens) no menu principal do OLYMPUS Master.
- b. Faça um clique no ícone "From Camera" (Da câmara).



Dicas

- Para obter informações pormenorizadas sobre a configuração e utilização da câmara, consulte o "Manual avançado" da câmara fornecido em CD-ROM.
- Para maiores detalhes sobre a utilização do software OLYMPUS Master, consulte o manual de referência (electrónica) localizado na pasta OLYMPUS Master no seu disco rígido. Para obter assistência adicional, consulte o ficheiro "Ajuda" no software OLYMPUS Master.

Software OLYMPUS Master

Software OLYMPUS Master: Utilize este software para transferir imagens da câmara, ver, organizar, retocar, enviar por correio electrónico e imprimir as suas imagens digitais, filmes e mais! Este CD também contém o manual de referência do software completo em formato Adobe Acrobat (PDF).



● Requisitos do sistema

SO	Windows 98SE/Me/2000 Professional/XP ou Mac OS X (10.2 ou posterior)
CPU	Pentium III 500 MHz/Power PC G3, ou superior
RAM	128 MB ou mais (Recomendamos 256 MB ou mais)
Disco rígido	300 MB ou mais de espaço livre
Ligação	Porta USB
Ecrã	1024 x Resolução de 768 pixels ou mais com mínimo de 65.536 cores (Windows), 32.000 cores (Macintosh)

Para obter as informações mais recentes de suporte técnico, visite o sítio da Web da Olympus

(<http://www.olympus.com/digital>)

Po

● Upgrade (OLYMPUS Master Plus)

Além das funções do OLYMPUS Master, o OLYMPUS Master Plus inclui as funções de edição de vídeo, impressão de álbuns, impressão de folhas de contacto, álbum HTML, junção panorama livre, gravação de CD/DVD e muito mais, o que lhe permite expandir imensamente as suas capacidades em termos de fotografia digital. É possível adquirir a versão PLUS do software OLYMPUS Master através da Internet. É necessário ter o OLYMPUS Master instalado num computador com uma ligação à Internet.



Registo do utilizador

Quando instalar o OLYMPUS Master, registe a sua câmara para activar a garantia, receber avisos sobre actualizações de software e do firmware da câmara e muito mais.

● **Câmara**

Tipo de produto	: Câmara Digital (para fotografar e visualizar)
Sistema de gravação	
Fotografias	: Gravação digital, JPEG (compatível com DCF)
Normas aplicáveis	: Exif 2.2, DPOF, PRINT Image Matching III, PictBridge
Filme	: Compatível com QuickTime Motion JPEG
Memória	: Memória interna xD-Picture Card (16 MB a 1 GB)
N.º de pixéis efectivos	: 6.000.000 pixéis
Dispositivo de captação de imagens	: CCD de 1/2,5" (filtro de cor primária), 6.400.000 pixéis (brutos)
Objectiva	: Objectiva Olympus de 4,6 a 23 mm, F3,3 a 4,8 (equivalente a 28 a 140 mm numa película de 35 mm)
Sistema fotométrico	: Medição de ESP digital
Velocidade de obturação	: 4 a 1/2000 seg.
Amplitude de fotografia	: 0,2 m a ∞ (W) 0,5 m a ∞ (T) (normal/modo macro) 0,05 m a 0,2 m (somente W) (modo super macro)
Monitor:	: Visor LCD a cores de 2,5" TFT, 153.600 pixéis
Conector externo	: Entrada DC-IN, conector USB (mini-B)/Tomada de saída AV (Multiconector)
Sistema de calendário automático	: Actualização automática de 2000 a 2099
Ambiente de funcionamento	
Temperatura	: 0 a 40°C (funcionamento)/-20 a 60°C (armazenamento)
Humidade	: 30% a 90% (funcionamento)/10% a 90% (armazenamento)
Alimentação	: Uma bateria de iões de lítio (LI-12B/LI-10B especificada para Olympus) ou o adaptador CA especificado
Dimensões	: 97,5 mm (L) × 59 mm (A) × 27 mm (P) (excluindo partes salientes)
Peso	: 155 g (sem bateria nem cartão)

● **Bateria de íões de lítio (LI-12B)**

Tipo de produto	: Bateria recarregável de íões de lítio
Voltagem padrão	: 3,7 V CC
Capacidade padrão	: 1.230 mAh
Vida útil da bateria	: Aprox. 300 recargas completas (varia conforme utilização)
Ambiente de funcionamento	
Temperatura	: 0°C a 40°C (32°F a 104°F) (recarga)/ -10°C a 60°C (14°F a 140°F) (funcionamento)/ 0°C a 30°C (32°F a 86°F) (armazenamento)/
Dimensões	: 32 × 46 × 10 mm (1,3 × 1,8 × 0,4 poleg.)
Peso	: Aprox. 30 g

● **Carregador de bateria (LI-10C)**

Requisitos de alimentação	: 100 a 240 V CA (50 a 60 Hz) 11 VA (100 V) a 17 VA (240 V)
Saída	: 4,2 V CC, 860 mA
Tempo de recarga	: Aprox. 120 min.
Ambiente de funcionamento	
Temperatura	: 0°C a 40°C (32°F a 104°F) (funcionamento)/ -20°C a 60°C (-4°F a 140°F) (armazenamento)/
Dimensões	: 46 × 36,5 × 80 mm (1,8 × 1,5 × 3,2 poleg.)
Peso	: Aprox. 70 g

Po

O design e as especificações estão sujeitas a alterações sem aviso previo.

Precauções de segurança



CUIDADO

NÃO ABRIR, PERIGO DE
CHOQUE ELÉCTRICO



CUIDADO: PARA REDUZIR O RISCO DE CHOQUE ELÉCTRICO, NÃO RETIRE A TAMPÃO (OU COBERTURA POSTERIOR). NÃO TOQUE NAS PARTES INTERNAS. CONTACTE OS SERVIÇOS TÉCNICOS QUALIFICADOS DA OLYMPUS.



O ponto de exclamação dentro de um triângulo, alerta o utilizador sobre a presença de partes importantes para o funcionamento e manutenção (serviços técnicos). Ver as instruções que acompanham este produto.



PERIGO

Se o produto for utilizado sem observância das informações acompanhadas deste símbolo, poderão ocorrer lesões graves ou morte.



ADVERTÊNCIA

Se o produto for utilizado sem observância das informações acompanhadas deste símbolo, poderão ocorrer lesões ou morte.



PRECAUÇÃO

Se o produto for utilizado sem observância das informações acompanhadas deste símbolo, poderão ocorrer lesões pessoais, danos no equipamento ou a perda de dados importantes.

ATENÇÃO!

PARA REDUZIR O RISCO DE FOGO OU DE CHOQUES ELÉCTRICOS, NÃO EXPONHA ESTE EQUIPAMENTO À CHUVA, EM CONTACTO COM LÍQUIDOS OU EM LOCAIS COM HUMIDADE.

Po

Precauções Gerais

Leia todas as instruções — Antes de utilizar o produto, leia todas as instruções de funcionamento. Guarde todos os manuais e instruções de segurança para futuras consultas.

Limpeza — Desligue sempre da tomada, antes de o limpar. Utilize apenas um pano macio para limpeza. Para limpar, nunca use nenhum tipo de líquido ou aerossol, ou solvente orgânico.

Acessórios — Para sua segurança e para evitar danos no produto, utilize apenas acessórios recomendados pela Olympus.

Água e Humidade — Para consultar as precauções sobre os produtos com características à prova de água, leia as respectivas secções.

Localização — Para evitar danos no produto, monte-o com segurança sobre um tripé, estante ou suporte estável.

Fonte de energia — Ligue este aparelho à fonte de energia designada para ele.

Relâmpagos — Se houver uma tempestade durante a utilização de um adaptador CA, desligue-o imediatamente da tomada da parede.

Objectos estranhos — Para evitar lesões pessoais, nunca insira objectos metálicos dentro do produto.

Calor — Nunca use ou guarde este produto perto de fontes de calor, tais como radiadores, aquecedores ou qualquer tipo de equipamento ou ferramenta que produza calor, incluindo amplificadores de som.

Manuseamento da Câmara



ADVERTÊNCIA

- **Não utilize a câmara perto de gases inflamáveis ou explosivos.**
- **Não utilize o flash a curta distância das pessoas (especialmente crianças, adolescentes, etc.).**
 - Deverá manter-se a uma distância mínima de 1 m da face das pessoas. Se disparar o flash muito próximo dos olhos da pessoa, pode causar uma perda momentânea da visão.
- **Mantenha as crianças e adolescentes fora do alcance da câmara.**
 - Utilize e guarde sempre a câmara fora do alcance das crianças e menores, para prevenir as seguintes situações de perigo que poderiam causar sérias lesões:
 - Ficar preso na correia da câmara, ocasionando asfixia.
 - Ingerir acidentalmente uma pilha ou uma pequena peça.
 - Disparar o flash acidentalmente sobre os seus próprios olhos ou sobre os olhos de uma criança.
 - Lesionar-se acidentalmente com as peças móveis da câmara.
- **Não olhe para o sol ou para luzes fortes através da câmara.**
- **Não utilize nem guarde a câmara em locais com pó ou humidade.**
- **Durante o disparo, não obstrua o flash com a mão.**

Po



PRECAUÇÃO

- **Interrompa imediatamente a utilização da câmara se notar algum cheiro, ruído ou fumo estranho a sair.**
 - Nunca remova as pilhas com as mãos desprotegidas, pois pode provocar fogo ou queimar as suas mãos.
- **Nunca segure nem opere a câmara com as mãos molhadas.**
- **Não deixe a câmara em locais onde possa estar sujeita a elevadas temperaturas.**
 - Caso contrário, as peças da câmara podem deteriorar-se e, em algumas circunstâncias, provocar incêndio na câmara. Não usar o carregador ou o adaptador de CA se estiver coberto (por exemplo, com um cobertor). Caso contrário, pode provocar sobreaquecimento ou fogo.
- **Manuseie a câmara com cuidado de modo a evitar alguma queimadura provocada por baixo calor.**
 - Quando a câmara contém peças metálicas, pode ocorrer o sobre-aquecimento das mesmas, resultando em queimaduras provocadas por baixo calor. Ter em atenção o seguinte:
 - Quando usada durante um longo período, a câmara ficará quente. Se continuar a segurar a câmara nestas condições, pode ocorrer uma queimadura de baixo calor.
 - Em locais sujeitos a temperaturas extremamente frias, a temperatura do corpo da câmara pode ser inferior à temperatura ambiente. Se possível, usar luvas ao manusear a câmara a baixas temperaturas.

● **Tenha cuidado com a correia.**

- Quando transportar a câmara tenha cuidado com a correia, já que, uma vez que é fácil enlaçá-la em objectos soltos em objectos soltos e causar sérios danos.

Precauções a respeito da manipulação das pilhas/bateria

Siga estas importantes indicações para evitar que ocorram fugas de líquido, sobre-aquecimento, incêndio ou explosão das pilhas ou para evitar choques eléctricos ou queimaduras.

 **PERIGO**

- A câmara utiliza uma bateria de iões de lítio especificada pela Olympus. Recarregue a bateria com o carregador especificado. Não utilize nenhum outro carregador.
- Nunca aqueça ou queime as pilhas.
- Tome precauções ao transportar ou guardar as pilhas a fim de evitar que entrem em contacto com objectos metálicos, tais como agramos, ganchos, jóias, etc.
- Nunca guarde as pilhas em lugares onde fiquem expostas a luz solar directa ou sujeitas a altas temperaturas ou no interior de um veículo com aquecimento, perto de uma fonte de calor, etc.
- Para evitar que ocorram fugas de líquido das pilhas ou danos dos seus terminais, siga cuidadosamente todas as instruções respectivas ao uso das pilhas. Nunca tente desmanchar a pilha nem modifica-la de nenhuma maneira, por soldadura, etc.
- Se o líquido da pilha penetrar nos seus olhos, lave-os de imediato com água corrente fresca e limpa, e procure assistência médica imediatamente.
- Guarde as pilhas sempre fora do alcance das crianças menores. Se um menor ingerir uma pilha acidentalmente, procure assistência médica imediatamente.

 **ADVERTÊNCIA**

- Mantenha as pilhas sempre secas.
- Para evitar que ocorram fugas de líquido, sobre-aquecimento ou que provoquem incêndio ou explosão, utilize exclusivamente as pilhas recomendadas para este produto.
- Insira a pilha cuidadosamente conforme descrito no manual de instruções.
- Se as pilhas recarregáveis não foram recarregadas dentro do tempo especificado, interrompa a recarga e não as utilize.
- Não usar uma pilha se estiver rachada ou partida.
- Se ocorrer um vazamento, descoloração ou deformação da pilha, ou qualquer outra anormalidade durante a operação, interrompa o uso da câmara.
- Se o líquido da pilha entrar em contacto com a roupa ou a pele, retire a roupa e lave de imediato a parte afectada com água corrente fresca e limpa. Se o líquido queimar a pele, solicite imediatamente cuidados médicos.
- Nunca exponha as pilhas a fortes impactos nem a vibrações contínuas.

PRECAUÇÃO

- Antes de inserir a bateria, inspecione-a sempre cuidadosamente quanto a vazamentos, descolorações, empenamentos ou quaisquer outras anormalidades.
- A bateria pode ficar quente durante o uso prolongado. Para evitar queimaduras menores, não a remova imediatamente após a utilização da câmara.
- Remova a bateria da câmara sempre que for guardar a câmara por um período prolongado.

Para Clientes na América do Norte e do Sul

Para Clientes nos EUA

Declaração de Conformidade

Modelo Número : FE-200

Nome Comercial : OLYMPUS

Parceiro Responsável: **OLYMPUS IMAGING AMERICA INC.**

Morada : 3500 Corporate Parkway, P.O. Box 610, Center Valley, PA
18034-0610 EUA.

Telefone Número : 484-869-5000

Testada Em Conformidade Com O Standard FCC
PARA USO DOMÉSTICO OU NO ESCRITÓRIO

Este aparelho está em conformidade com a Capítulo 15 das Regras FCC. O seu funcionamento está sujeito a duas condições:

- (1) Este aparelho não pode causar perigo de interferência.
- (2) Este aparelho pode receber qualquer tipo de interferência, inclusive interferências que possam originar o seu mau funcionamento.

Para Clientes no Canadá

Este aparelho digital da Classe B está em conformidade com a Regulamentação Canadiana para Equipamentos Causadores de Interferências.

Po

Marcas Comerciais

- A IBM é uma marca comercial registada da International Business Machines Corporation.
- Microsoft e Windows são marcas comerciais registadas da Microsoft Corporation.
- Macintosh é uma marca comercial registada da Apple Computers Inc.
- xD-Picture Card™ é uma marca registada.
- Todas as outras companhias e nomes de produtos são marcas comerciais registadas e/ou marcas comerciais dos respectivos fabricantes.
- Os standards referidos neste manual para os sistemas de ficheiro da câmara são os standards DCF (“Design Rule for Camera File System”) estipulados pela JEITA (“Japan Electronics and Information Technology Industries Association”).

Memo



Memo

Memo

OLYMPUS®

<http://www.olympusamerica.com/>

OLYMPUS IMAGING AMERICA INC.

3500 Corporate Parkway, P.O. Box 610, Center Valley, PA 18034-0610, U.S.A. Tel. 484-896-5000

Technical Support (USA)

24/7 online automated help: <http://www.olympusamerica.com/support>

Phone customer support: Tel. 1-888-553-4448 (Toll-free)

Our phone customer support is available from 8 am to 10 pm (Monday to Friday) ET

E-Mail: distec@olympus.com

Olympus software updates can be obtained at: <http://www.olympusamerica.com/digital>

To find the nearest Authorized Distributor, please visit: <http://www.olympusamerica.com/digital>,

and click on the Worldwide Warranty icon at the bottom of the page.

Authorized Distributors

U.S.A.:

Los Angeles **Olympus Imaging America Inc.**

10805 Holder Street Suite 170
Cypress, CA 90630-5145
Tel: (888) 553-4448

New York **Olympus Imaging America Inc.**

400 Rabro Drive
Hauppauge, NY 11788-4258
Tel: (888) 553-4448

Canada:

Calgary **Alta Camera Service**

107-10 Ave. SW, Calgary, Alberta T2R 1K8
Tel: (403) 234-0400

Mississauga **Nortown Photo Service**

3045 Southcreek Road Unit 33
Mississauga, Ontario L4X 2X6
Tel: 1-877-677-3686 Fax: (905) 624-6167
E-mail: service@nortownphoto.com

Montreal **AMT Service Inc.**

5215 de la Savane
Montreal, Quebec H4P 1V4
Tel: (514) 738-7044 Fax: (514) 738-4229

Vancouver **Vancam Service Ltd.**

1666 West 8th Ave., Vancouver,
B.C. V6J 1V4 Tel: (604) 736-4113

Winnipeg **Computech Camera Repairs Ltd.**

119 Sherbrook Street
Winnipeg, Manitoba R3C 2B5
Tel: (204) 786-2693

Mexico: **Olympus Imaging de Mexico S.A. de C.V.**

WTC Mexico,
Montecito No.38 - Lobby - Office 3
Col. Napoles, Mexico D.F. 03810
Tel. (5255) 54881280
E-mail: pedro.jimenez@olympus.com

Argentina: **Jesus Labrador S.A.**

Paraguay 755 PB, C1057 AAI Buenos Aires
Tel: (011) 4313-3174 Fax: (011) 4312-5239
E-Mail: jesuslabrador@speedy.com.ar
Jesus Labrador S.A.
Sucursal Mitre, Bartolome Mitre 860
C1036AAP Buenos Aires Tel: (011) 4331-1227
E-mail: jesuslabrador@speedy.com.ar

Brazil:

Rio de Janeiro **Assistec**

Rua Uruguiana, 94-Sobreloja
Centro-Rio de Janeiro CEP 20050-091
Tel: (021) 2242-3236 Fax: (021) 2242-3236
E-Mail: rio@assistecs.com.br

Sao Paulo **Assistec**

Rua Avanhandava 126, 3 Andar
Consolação, São Paulo
Tel: (011) 3123-3100 Fax: (011) 3214-0706
E-mail: ASSISTECSS@UOL.COM.BR

Assistec

Filial Shopping Eldorado
Av. Rebouças 3970, 1 Subsolo, Loja 1035
Pinheiros, Sao Paulo
Tel: (011) 3815-3054 Fax: (011) 3814-4398
E-mail: ASSISTECSS@UOL.COM.BR

Chile:

Reifschneider Foto S.A. C.I.

Camino Conquistador del monte 5024
Huechuraba, Santiago Tel: 56-02-443-1500
E-mail: ceciliacalvo@reifschneider.cl

Colombia:

CV Tronica LTDA

Calle 68 No 12-57, Bogota
Tel: (0571)235-7260/348-1573
Fax: (0571) 348-1574
E-mail: servicio@cvtronica.com

Panama:

FOTOSER

Edif. El Paical, Oficina No3, P.A.
Urb. Herbruger, Transistmica
(Detras del S/M Riba Smith),
Tel/Fax: (507) 261-0436
E-mail: rearanda@rocketmail.com

Uruguay:

Fotocamera S.R.L.

Cuareim 1439 Montevideo
Tel: (02) 900-2004 Fax: (02) 900-8430
E-mail: FOTOCAM@ADINET.COM.UY

Venezuela:

Micron C.A.

4ta. transversal Urb. Horizonte,
Edificio América, Mezanine, Caracas 1070-A
Tel: (012) 238-3526 Fax: (012) 239-8598
E-mail: guillermolandaeta@micron.com.ve