

Smart  
I

# User Manual

©  
R  
P

Congratulations on the purchase of your new Windows Mobile™ **Smartphone!**

**Please Read Before Proceeding.**

**THIS DEVICE IS NOT CHARGED WHEN YOU TAKE IT OUT OF THE BOX.**

**DO NOT REMOVE THE BATTERY PACK WHEN THE DEVICE IS CHARGING.**

**YOUR WARRANTY IS INVALIDATED IF YOU OPEN OR TAMPER WITH THE DEVICE'S OUTER CASING.**

#### **PRIVACY RESTRICTIONS**

Some countries require full disclosure of recorded telephone conversations, and stipulate that you must inform the person with whom you are speaking that the conversation is being recorded. Always obey the relevant laws and regulations of your country when using the recording feature of your phone.

#### **COPYRIGHT INFORMATION**

Microsoft, MS-DOS, Windows, Windows NT, Windows Server, Windows Mobile, ActiveSync, Excel, Internet Explorer, MSN, Outlook, PowerPoint, and Word are either registered trademarks or trademarks of Microsoft Corporation in the United States and/or other countries.

## Important Health Information and Safety Precautions

When using this product, the safety precautions below must be taken to avoid possible legal liabilities and damages.

Retain and follow all product safety and operating instructions. Observe all warnings in the operating instructions on the product.

To reduce the risk of bodily injury, electric shock, fire and damage to the equipment, observe the following precautions.

### ELECTRICAL SAFETY

This product is intended for use when supplied with power from the designated battery or power supply unit. Other usage may be dangerous and will invalidate any approval given to this product.

### SAFETY PRECAUTIONS FOR PROPER GROUNDING INSTALLATION

**CAUTION** – Improper connection of associated equipment-grounding can result in a risk of electric shock.

This product equipped with an ActiveSync Cable for connecting with desktop or notebook computer. Be sure your computer is properly grounded (earthed) before connecting this product to the computer. The desk-top or notebook computer is equipped with a power supply cord having an equipment grounding conductor and a grounding plug. The plug must be plugged into an appropriate outlet which is properly installed and grounded in accordance with all local codes and ordinances.

### SAFETY PRECAUTIONS FOR POWER SUPPLY UNIT

- **Use the correct external power source**

A product should be operated only from the type of power source indicated on the electrical ratings label. If you are not sure of the type of power source required, consult your authorized service provider or local power company. For a product that operates from battery power or other sources, refer to the operating instructions that are included with the product.

- **Handle battery packs carefully**

This product contains a Li-ion Polymer battery. There is a risk of fire and burns if the battery pack is handled improperly. Do not attempt to open or service the battery pack. Do not disassemble, crush, puncture, short external contacts or circuits, dispose of in fire or water, or expose a battery pack to temperatures higher than 60°C (140°F).

**WARNING!**

DANGER OF EXPLOSION IF BATTERY IS INCORRECTLY REPLACED. TO REDUCE RISK OF FIRE OR BURNS, DO NOT DISASSEMBLE, CRUSH, PUNCTURE, SHORT EXTERNAL CONTACTS, EXPOSE TO TEMPERATURE ABOVE 60°C (140°F), OR DISPOSE OF IN FIRE OR WATER. REPLACE ONLY WITH SPECIFIED BATTERIES. RECYCLE OR DISPOSE OF USED BATTERIES ACCORDING TO THE LOCAL REGULATIONS OR REFERENCE GUIDE SUPPLIED WITH YOUR PRODUCT.



**Li-ion**



### **SAFETY PRECAUTIONS FOR DIRECT SUNLIGHT**

Keep this product away from excessive moisture and extreme temperatures. Do not leave the product or its battery inside a vehicle or in places where the temperature may exceed 60°C (140°F), such as on a car dashboard, window sill, or behind a glass that is exposed to direct sunlight or strong ultraviolet light for extended periods of time. This may damage the product, overheat the battery, or pose a risk to the vehicle.

### **SAFETY PRECAUTIONS FOR ACOUSTIC PRESSURE**

**CAUTION** –Permanent hearing loss may occur if earphones or headphones are used and prolonged listening at high volume.

**NOTE:**



For France, mobile headphones or earphones for this device (Manufactured by Supplier Name:COTRON, Model Numbers:CHM-201STV03030) has been tested to comply with the Sound Pressure Level requirement laid down in NF EN 50332-1:2000 standard as required by French Article L. 5232-1.

### **SAFETY IN AIRCRAFTS**

Due to the possible interference caused by this product to an aircraft's navigation system and its communications network, using this device's phone function on board an airplane is against the law in most countries. If you want to use this device when on board an aircraft, remember to turn off your phone by switching to Flight Mode.

## **ENVIRONMENT RESTRICTIONS**

Do not use this product in gas stations, fuel depots, chemical plants or where blasting operations are in progress, or in potentially explosive atmospheres such as fuelling areas, fuel storehouses, below deck on boats, chemical plants, fuel or chemical transfer or storage facilities, and areas where the air contains chemicals or particles, such as grain, dust, or metal powders. Please be aware that sparks in such areas could cause an explosion or fire resulting in bodily injury or even death.

## **EXPLOSIVE ATMOSPHERES**

When in any area with a potentially explosive atmosphere or where flammable materials exist, the product should be turned off and the user should obey all signs and instructions. Sparks in such areas could cause an explosion or fire resulting in bodily injury or even death. Users are advised not to use the equipment at refueling points such as service or gas stations, and are reminded of the need to observe restrictions on the use of radio equipment in fuel depots, chemical plants, or where blasting operations are in progress. Areas with a potentially explosive atmosphere are often, but not always, clearly marked. These include fueling areas, below deck on boats, fuel or chemical transfer or storage facilities, and areas where the air contains chemicals or particles, such as grain, dust, or metal powders.

## **ROAD SAFETY**

Vehicle drivers in motion are not permitted to use telephony services with handheld devices, except in the case of emergency. In some countries, using hands-free devices as an alternative is allowed.

## **INTERFERENCE WITH MEDICAL EQUIPMENT FUNCTIONS**

This product may cause medical equipment to malfunction. The use of this device is forbidden in most hospitals and medical clinics.

## **NONIONIZING RADIATION**

This product should be operated in the suggested normal condition only to ensure the radiative performance and safety of the interference. As with other mobile radio transmitting equipment, users are advised that for satisfactory operation of the equipment and for the safety of personnel, it is recommended that no part of the human body be allowed to come too close to the antenna during operation of the equipment

## General Precautions

- **Heed service markings**

Except as explained elsewhere in the Operating or Service documentation, do not service any product yourself. Service needed on components inside these compartments should be done by an authorized service technician or provider.

- **Damage requiring service**

Unplug the product from the electrical outlet and refer servicing to an authorized service technician or provider under the following conditions:

- Liquid has been spilled or an object has fallen into the product.
- The product has been exposed to rain or water.
- The product has been dropped or damaged.
- There are noticeable signs of overheating.
- The product does not operate normally when you follow the operating instructions.

- **Avoid hot areas**

The product should be placed away from heat sources such as radiators, heat registers, stoves, or other products (including amplifiers) that produce heat.

- **Avoid wet areas**

Never use the product in a wet location.

- **Avoid pushing objects into product**

Never push objects of any kind into cabinet slots or other openings in the product. Slots and openings are provided for ventilation. These openings must not be blocked or covered.

- **Mounting Accessories**

Do not use the product on an unstable table, cart, stand, tripod, or bracket. Any mounting of the product should follow the manufacturer's instructions, and should use a mounting accessory recommended by the manufacturer.

- **Avoid unstable mounting**

Do not place the product with an unstable base.

- **Use product with approved equipment**

This product should be used only with personal computers and options identified as suitable for use with your equipment.

- **Adjust the volume**

Turn down the volume before using headphones or other audio devices.

- **Cleaning**

Unplug the product from the wall outlet before cleaning. Do not use liquid cleaners or aerosol cleaners. Use a damp cloth for cleaning, but NEVER use water to clean the LCD screen.

# Contents

## **Chapter 1 Getting Started 11**

- 1.1 Getting to Know your Phone and its Accessories .. 12
- 1.2 Inserting the SIM Card ..... 18
- 1.3 Installing the Micro SD Card ..... 19
- 1.4 The Home Screen ..... 20
- 1.5 Status Indicators and Program Icons..... 21
- 1.6 Using the Start Menu..... 24
- 1.7 Using the Quick List..... 24
- 1.8 Entering Information ..... 25
- 1.9 Battery Information ..... 28

## **Chapter 2 Using Phone Features 29**

- 2.1 Using the Phone ..... 30
- 2.2 Making a Call ..... 31
- 2.3 Receiving a Call ..... 34
- 2.4 In-Call Options ..... 34
- 2.5 Additional Dialing Information ..... 36

## **Chapter 3 Synchronizing Information and Setting Up E-mail Security 39**

- 3.1 About ActiveSync..... 40



3.2	Setting Up ActiveSync .....	40
3.3	Synchronizing Information .....	43
3.4	Synchronizing via Bluetooth .....	47
3.5	Synchronizing Music and Video .....	48
3.6	Setting Up E-mail Security .....	49

## **Chapter 4 Managing your Phone** **51**

4.1	Personalizing your Phone .....	52
4.2	Adding and Removing Programs.....	58
4.3	Using Task Manager and Managing Memory .....	60
4.4	Managing and Backing Up Files .....	61
4.5	Protecting your Phone .....	64
4.6	Restarting your Phone .....	66
4.7	Resetting your Phone .....	66

## **Chapter 5 Getting Connected** **67**

5.1	Connecting to the Internet.....	68
5.2	Using Internet Explorer Mobile .....	72
5.3	Using Wireless Modem .....	74
5.4	Using Comm Manager .....	78
5.5	Using Bluetooth.....	79

## **Chapter 6 Exchanging Messages and Using Outlook** **87**

6.1	Using E-mail and Text Messages .....	88
-----	--------------------------------------	----

6.2	Using MMS Messages .....	97
6.3	Using Pocket MSN Messenger .....	104
6.4	Using Calendar .....	105
6.5	Using Contacts .....	107
6.6	Using Tasks.....	112
6.7	Using Voice Notes .....	113
<b>Chapter 7 Experiencing Multimedia</b>		<b>115</b>
7.1	Using Camera and Video Recorder .....	116
7.2	Using Pictures & Videos .....	125
7.3	Using Windows Media Player.....	130
7.4	Using MIDlet Manager.....	138
<b>Chapter 8 Using Other Applications</b>		<b>143</b>
8.1	Using ClearVue Suite .....	144
8.2	Using Speed Dial .....	148
<b>Appendix</b>		<b>151</b>
A.1	Regulatory Notices.....	152
A.2	PC Requirement to Run ActiveSync 4.x.....	157
A.3	Specifications .....	158
<b>Index</b>		<b>161</b>

# Chapter 1

## Getting Started

- 1.1 Getting to Know your Phone and its Accessories**
- 1.2 Inserting the SIM Card**
- 1.3 Installing the Micro SD Card**
- 1.4 The Home Screen**
- 1.5 Status Indicators and Program Icons**
- 1.6 Using the Start Menu**
- 1.7 Using the Quick List**
- 1.8 Entering Information**
- 1.9 Battery Information**

## 1.1 Getting to Know your Phone and its Accessories

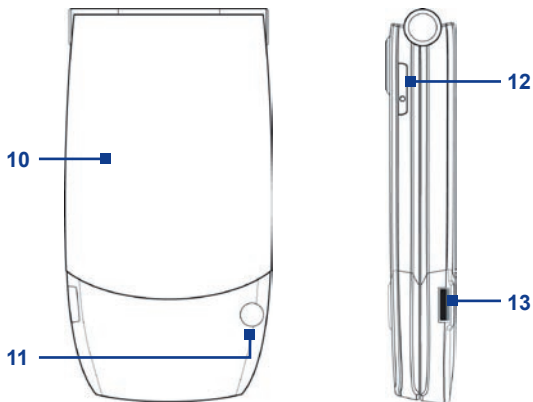
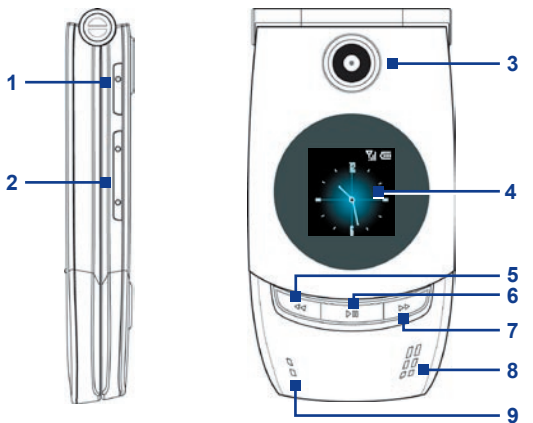



Item	Function
1. <b>Voice Notes/ Voice Tag</b>	Long press to launch Voice Notes recorder. Short press to launch Voice Tag feature. Please note the button does not work when the flip cover is closed.
2. <b>Volume</b>	Press to increase or decrease the earpiece volume during a call.
3. <b>Camera Lens</b>	1.3 Mega-pixel CMOS lens on the flip cover. It supports the self-capturing feature from the external screen when the flip cover is closed.
4. <b>External Screen</b>	When your phone is powered on and the flip cover is closed, the external screen shows the device status. To customize the display of the external screen, see the “Set up the external screen” section in Chapter 4.
5. <b>Rewind</b>	When Media Player is running, press this hotkey to go back to the beginning of the current file; quickly press twice to jump to the previous file. If Media Player is launched in foreground but no file is loaded, nothing happens when you press this hotkey.
6. <b>Play/Pause</b>	When the flip cover is closed, press this hotkey to launch Windows Media Player directly.
7. <b>Forward</b>	When Media Player is running, press this hotkey to jump to the next file. If Media Player is launched in foreground but no file is loaded, nothing happens when you press this hotkey.
8. <b>Speaker</b>	Listen to audio media.
9. <b>LED Indicators</b>	The upper bi-color LED Indicator (amber/red/green) notifies you of the battery and network status of your phone respectively, while the lower blue LED indicator notifies you of Bluetooth connectivity status. For more information about LED Indicators, see the table at the end of this section.
10. <b>Battery Cover</b>	
11. <b>External Antenna Connector</b>	Connect your phone to an external antenna (if available) to utilize the superior reception quality.
12. <b>Camera</b>	Press to launch the camera. If already running, press to capture an image or start recording a video clip.
13. <b>Earphone/ Sync/Power Connector</b>	Connect the USB cable to synchronize data or recharge the battery; plug the provided Stereo headset to use the hands-free kit or listen to audio media; or, plug the AC adapter to recharge the battery

---

## 14 Getting started



Item	Function
14. <b>Earpiece</b>	Listen to a phone call.
15. <b>Display Screen</b>	
16. <b>Left Soft Key</b>	Press to perform the command shown in the label above the button.
17. <b>TALK</b>	Press to dial a phone number, answer a call, switch to another call, or put a call on hold. Hold to activate/deactivate loudspeaker mode.
18. <b>HOME</b>	Press to go to the Home Screen. Press and hold to open the Quick List.
19.  <b>Key</b>	Press and switch to different input modes or press and hold to choose an input mode or symbols from the list.
20. <b>Light Sensor</b>	Dark conditions sensed here will activate a backlight under the keypad, making it easier to see the buttons.
21. <b>Right Soft Key</b>	Press to perform the command shown in the label above the button.
22. <b>Power/END</b>	Press and hold to turn on/off the phone. Or during a call, press to end the call.
23. <b>Back</b>	Press to go to the previous screen, or backspace over characters.
24. <b>Navigation Control/ENTER</b>	Use to scroll left, right, up, or down. Or press straight down to use as the ENTER button.
25.  <b>Key</b>	Press to add a space or press and hold to display a list of symbols.
26. <b>Microphone</b>	Speak into the microphone when receiving or making a phone call or voice recording.

---

## LED indicator lights

Various colors that might display in the two LED Indicators are summarized here.

Upper LED	Status
<b>Solid green</b>	Battery is fully charged.
<b>Blank</b>	Device is powered off, device in flight mode or no network coverage.
<b>Solid amber</b>	Battery is charging or the phone is using ActiveSync to synchronize with a PC.
<b>Flashing green</b>	Connected to the network.
<b>Flashing red</b>	Battery very low (less than 4%).
<b>Flashing amber</b>	Battery temperature is hotter or colder than the functional limits of 0 to 48 degrees Celsius, and has stopped charging.
<b>Amber/Green LED off</b>	Battery fault. The “Battery Fault” indicator (  ) is displayed. In this case, the flashing green LED can be recovered by unplugging the AC adapter.
<b>Dim</b>	Disconnected from the network.
Lower LED	Status
<b>Flashing blue</b>	Bluetooth mode set to “On” or “Discoverable” mode.



## Accessories

The following accessories are provided with the device:

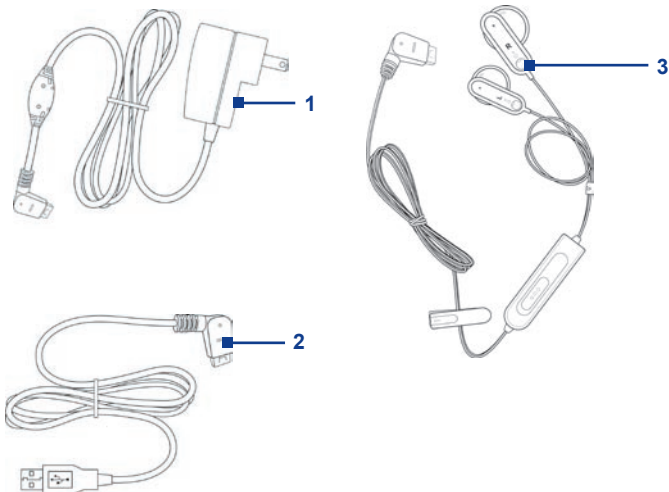

Accessory	Function
1. <b>AC adapter</b>	Recharge the device battery.
2. <b>USB cable</b>	Connect your device to a PC and synchronize data.
3. <b>Stereo headset</b>	Provide a volume control jog dial and a Send/End button. You can use the button to pick up and hang up incoming and outgoing calls. Plug into Earphone/Sync connector to listen to audio files.

## 1.2 Inserting the SIM Card

Your SIM (Subscriber Identity Module) card is given to you by your wireless service provider and contains your basic subscriber information, such as your phone number and your address book.

Before you begin, ensure that the phone is turned off.

- 1. Open the battery cover:** Hold the phone in one hand with the front panel facing down in the palm of your hand. The other hand press down on the battery cover and slide it open.
- 2. Insert the SIM card:** Insert the SIM card into the SIM card slot with its gold contacts facing down. When completed, replace the battery cover.

To take the SIM card out, press the bottom of the SIM card to slide it out of the slot. Then lightly lift up the SIM card.

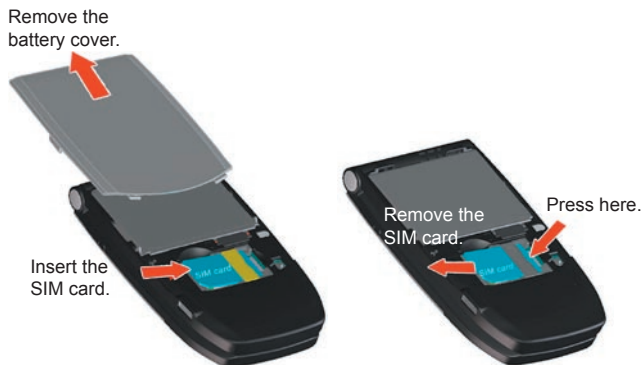

## 1.3 Installing the Micro SD Card

1. Open the battery cover.
2. Remove the SIM card if you have installed.
3. Lift up the Micro SD card metal socket, and insert the Micro SD card into the slot.

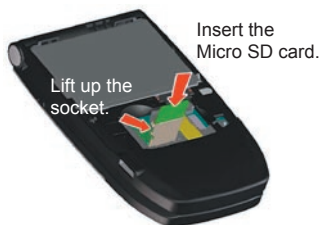

4. Push the metal socket down.
5. Replace the SIM card, battery and battery cover.

## 1.4 The Home Screen

The Home screen displays important information, such as upcoming appointments, status indicators, the current date, time, and profile, and icons of programs that you have recently used. You can open a program directly by selecting its icon and pressing ENTER.

- To access the Home screen from anywhere, press HOME.
- To customize the Home screen display, including the background, click **Start > Settings > Home Screen**.





































Home Screen

1. Select a recently-used program, and open it directly from the Home screen.
2. Displays the name of your wireless service provider. Click to launch the Communication manager.
3. Click to view the details of a missed call.
4. Click to see the time of your next appointment.
5. Displays the current profile. Click to change the profile.
6. Click to open the Messages folder.
7. Click to display all program icons.
8. Displays notifications, such as missed calls or new messages.
9. Displays the GPRS or GSM network status.
10. Displays the power status.
11. Displays the network signal strength.
12. Displays the current date and time.
13. Click to open Contacts, Call History, or Messages.















## 1.5 Status Indicators and Program Icons

The following table lists common status indicators and their meanings.

 GPRS available	 New e-mail or text message (SMS, Short Message Service)
 GPRS connected	 New instant message
 Voice call in progress	 Multipress text input mode, lowercase
 Data call in progress	 Multipress text input mode, uppercase
 Calls forwarded	 Multipress text input mode, caps lock
 Call on hold	 T9 text input mode, lowercase
 Missed call	 T9 text input mode, uppercase
 Dialing while no SIM card installed	 T9 text input mode, caps lock
 Speakerphone on	 Numeric input mode
 Battery level	 Ringer off
 Low battery	 Vibrate call alert
 Very low battery	 Microphone muted
 Battery charging	 Bluetooth
 No battery or battery fault	 No SIM card installed
 Signal strength	 SIM card with fault
 Radio connected or no signal	 Roaming
 Radio off	 1 / 2 Line 1/2
 Sync error	

## 22 Getting started

The following table lists icons of the programs that are already installed on your phone.

	<b>ActiveSync</b>	Synchronizes information between your phone and a PC.
	<b>Calculator</b>	Performs basic arithmetic and calculations, such as addition, subtraction, multiplication, and division.
	<b>Calendar</b>	Keeps track of your appointments, and creates meeting requests.
	<b>Call History</b>	Keeps track of all phone calls made, received, and missed.
	<b>Camera</b>	Captures photos in various modes.
	<b>Clear Storage</b>	Clears the memory, restores the phone back to factory default settings, then restarts the phone.
	<b>ClearVue Document</b>	Lets you view Word documents on your phone.
	<b>ClearVue PDF</b>	Lets you view PDF files on your phone.
	<b>ClearVue PPT</b>	Lets you view PowerPoint files on your phone.
	<b>ClearVue Worksheet</b>	Lets you view Excel worksheets on your phone.
	<b>Comm Manager</b>	Lets you easily enable or disable your phone, start or stop synchronization with your computer, mute your phone, enable or disable Bluetooth, stop data services and enable or disable Direct Push.
	<b>Contacts</b>	Keeps track of contact information.
	<b>Download Agent</b>	Provides information about the download status and the downloaded content from the Internet.
	<b>File Explorer</b>	Lets you organize and manage files on your phone.
	<b>Games</b>	Lets you play two games: Bubble Breaker and Solitaire come with your phone.

	<b>Internet Explorer</b>	Allows you to browse Web and WAP sites, and to download new programs and files from the Internet.
	<b>Messaging</b>	Lets you send and receive e-mails and text messages.
	<b>MIDlet Manager</b>	Lets you download and install Java-based applications, such as games and tools, on your phone.
	<b>Pictures &amp; Videos</b>	Collects, organizes, and sorts picture and video files in the My Pictures folder on your phone or on a storage card.
	<b>Pocket MSN</b>	Lets you send and receive instant messages with your MSN Messenger contacts.
	<b>Settings</b>	Personalize your phone to suit the way you use it.
	<b>Speed Dial</b>	Lets you create speed dial entries for dialling frequently-called phone numbers or for opening frequently-accessed programs.
	<b>SIM Manager</b>	Lets you manage the contacts that are stored on your SIM card. You can also use this program to copy SIM contents to Contacts on your phone.
	<b>STK (SIM Tool Kit) Service</b>	Allows you to access information and other services offered by your wireless service provider.
	<b>Task Manager</b>	Keeps track of your on-going programs.
	<b>Tasks</b>	Keeps track of your tasks.
	<b>Video Recorder</b>	Captures video clips in various modes and duration.
	<b>Voice Notes</b>	Allows you to make short voice recordings.
	<b>Windows Media</b>	Lets you play back video and audio files.
	<b>Wireless Modem</b>	Enables your device as an external modem for a PC by using a Bluetooth port or USB port.

## 1.6 Using the Start Menu

The Start menu is located at the bottom-left corner of the Home screen and displays various program icons that are spread across one or more screens.

### To see the available programs in the Start menu

- On the Home screen, click **Start**.
- To see more programs, click **More**.

Your phone comes with several bundled programs that you can start using immediately. You can also install additional programs from the included Windows Mobile™ Getting Started Disc or from the Internet, or purchase mobile phone software from retail stores and install them to your phone.



## 1.7 Using the Quick List

The Quick List offers convenient access to a list of functions, such as locking your phone or keypad, and choosing a different profile. For more information about profiles, see Chapter 4.

### To access the Quick List

1. Press and hold the HOME button.
2. Scroll through the list and select the desired item by clicking **Select**, pressing the ENTER button, or pressing the related numeric key on the keypad.
3. To exit the Quick List at any time, click **Cancel**.

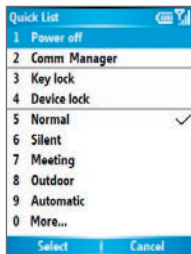



## 1.8 Entering Information

You can enter text and numbers by using the keypad. The phone supports three input modes for entering text and numbers: Multipress, T9, and Numeric. Multipress and T9 modes are used for entering text, and Numeric mode is used for entering numbers.

When you select a field that requires entering text or numbers, the phone automatically selects the appropriate input mode. The status indicator on the top-right side of the display screen shows the input mode that you are currently using.

<b>abc</b>	Multipress text input mode, lowercase
<b>Abc</b>	Multipress text input mode, uppercase
<b>ABC</b>	Multipress text input mode, caps lock
<b>t9</b>	T9 text input mode, lowercase
<b>T9</b>	T9 text input mode, uppercase
<b>T9</b>	T9 text input mode, caps lock
<b>123</b>	Numeric input mode

### To change the input mode

1. Press and hold the **\*T9** key.
2. On the menu, click the input mode you want.

### Use Multipress mode

In Multipress mode, you can enter a character by pressing the numeric key on which the character appears.

#### To enter text in Multipress mode

- To enter the first character on the numeric key, press once. To enter the second character on the numeric key, press twice, and so on.
- To enter character that are on the same numeric key, pause after you enter the first character.
- To enter punctuation, press **1** repeatedly until you see the punctuation you want.

### To change the Multipress time out



You can change the length of time to pause between keypresses on the same numeric key.

1. On the Home screen, click **Start > Settings > Accessibility**.
2. In **Multipress time out**, select the length of the pause between keypresses.

### Use T9 mode

To form a word in T9 mode, press the numeric keys that contain the letters you want. As you enter letters, T9 analyzes your keypresses and attempts to complete the word. For example, to enter the word “shoe,” press 7, 4, 6, 3.



### To enter text in T9 mode

1. Press and hold the  key.
2. On the menu, click **T9**.
3. Do any of the following:
  - Enter letters by pressing the keys on which the letters appear. Press a key only once for each letter. If there is more than one choice in the T9 dictionary for your entry, a list of available words is displayed.
  - Press the  key to enter a space after the word as entered, or click one of the available words and the space is added automatically.
  - If you do not see the desired word, click **Add Word?** from the list, and then enter the word using Multipress.
  - To enter punctuation, press **1**, and select from a list of common punctuation.

### Use Numeric mode

If a text box permits a numeric entry only, such as a phone number, the input mode automatically defaults to Numeric mode. However, if you need to enter numbers within a line of text, change to Numeric mode, and then change back to Multipress or T9 mode to finish entering the text.

### To enter numbers in text boxes

1. Press and hold the  key to change to Numeric mode.
2. On the keypad, enter the number or numbers you want.
3. Change back to Multipress or T9 input mode by pressing and holding the  key, and then finish entering your text.

### More text entry tasks

In both Multipress and T9 modes, the first letter of a sentence is by default capitalized.

### To change between uppercase, lowercase, and caps lock

- Press the  key to change between uppercase, lowercase, and caps lock within a text input mode.

### To delete characters

- To backspace and delete a single character in any input mode, press BACK.
- To backspace and delete an entire text or numeric field in any input mode, press and hold BACK.

### To enter a space

- In Multipress or T9 mode, press the  key.

### To enter a symbol

1. Press and hold the  key.
2. On the menu, click **Symbols** to display the Symbol page.
3. Select the symbol you want and press ENTER.

### To start a new line

In a multi-line text box such as the notes area of a contact or a calendar appointment, do the following:

- In any input mode, press ENTER.

### To enter the plus sign for international calls

- In a numeric entry box, press and hold 0.

## 1.9 Battery Information

Battery performance depends on many factors, including your wireless service provider's network configuration, signal strength, the temperature of the environment in which you operate your phone, the features and/or settings you select and use, items attached to your phone's connecting ports, and your voice, data, and other program usage patterns.

Battery life estimates (approximations):

- Talk time: 2.5 ~ 5 hours
- Standby time: 100 ~ 150 hours

**WARNING!** To reduce risk of fire or burns:

- Do not attempt to open, disassemble, or service the battery pack.
- Do not crush, puncture, short external contacts, or dispose of in fire or water.
- Do not expose to temperatures above 60°C (140°F).
- Replace only with the battery pack designated for this product.
- Recycle or dispose of used battery as stipulated by local regulation.

### The Power Management screen

- On the Home screen, click **Start > Settings > Power Management** to access the Power Management screen. You can check the battery power from the Main battery bar.
- On Power Management screen, you can optimize the power performance by adjusting the backlight, display, and light sensor settings.

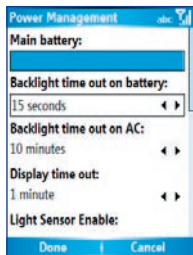

### To manage a low battery

When the low-battery warning appears, do the following:

1. Immediately save your current data.
2. Synchronize with your PC to charge the battery.
3. Turn off your phone.

For information about charging the battery, see the **Quick Start Guide**.

# Chapter 2

## Using Phone Features

**2.1 Using the Phone**

**2.2 Making a Call**

**2.3 Receiving a Call**

**2.4 In-Call Options**

**2.5 Additional Dialing Information**



## 2.1 Using the Phone

You can use your phone to make, receive, and keep track of calls, and send text messages (SMS, Short Message Service) and MMS (Multimedia Messaging Service) messages. You can also dial a phone number directly from Contacts, and easily copy SIM contacts to Contacts on the phone.

### The Phone screen

From the Phone screen, you can open, call, or find a contact, and even save a new number in Contacts. To access the Phone screen, do any of the following:

- Press TALK (.
- Directly enter the phone number by pressing numeric keys on the keypad.

### Enter your PIN

Most Subscriber Identity Module (SIM) cards are preset with a personal identification number (PIN) that is provided by your wireless service provider. You need to enter the PIN whenever you use your phone.

1. On the Home screen, click **Start > Settings > Security > Enable SIM PIN**.
2. Enter the preset PIN provided by your wireless service provider.
3. Click **Done**.

**Note** If your PIN is entered incorrectly three times, the SIM card will be blocked. If this happens, you can unblock it with the PIN Unlocking Key (PUK) obtained from your wireless service provider.

### Set ring tones

You can choose how to be notified for incoming calls, reminders, new messages, alarms, and more.

### To set a ring tone for incoming calls

1. On the Home screen, click **Start > Settings > Sounds**.
2. In the Ring tone list, select a ring tone.
3. Click **Done**.

If you select **Vibrate**, the sound is muted and the phone will vibrate when you receive a call. The vibrate icon (🔇) appears in the title bar. Selecting **None** in the Ring tone list mutes the phone. For more information about sounds, see “Choose how to be notified about events or actions” in Chapter 4.

**Note** To adjust the earpiece volume during a call, press the VOLUME control on the phone side panel. Adjusting the volume at any other time can affect the ring, notification, and MP3 sound levels.

## 2.2 Making a Call

With your phone, you can make calls from the Home screen, the Phone screen, from Contacts, Speed Dial, Call History, or SIM Contacts (contacts stored on your SIM card).

### Make a call from the Phone screen

1. On the Home screen, access the Phone screen by pressing TALK (📞) or pressing numeric keys on the keypad.
2. When you enter the phone number completely, press TALK (📞).



Phone Screen

### Tips

- While entering the phone number, press the **BACK** button if you need to backspace.
- You will notice that when you press a numeric key on the keypad, a list of names and numbers is displayed as your phone searches **Contacts**, **Call History**, **Speed Dial**, and your **SIM card** to find a matching name or number. For example, when you press a number such as 5, names that begin with J, K, and L will be displayed as well as phone numbers that start with 5. The next number you press continues to narrow the search. When you see the name of the person you want to call, select it, and press **TALK** (📞).

### Make a call from Contacts

1. On the Home screen, click **Start > Contacts**.
2. Do one of the following:
  - Select the desired contact, and press **TALK** (📞).
  - Select the desired contact in the contact list, and press the **ENTER** button twice (once to view the contact details, and once to dial the associated number).

### To specify the number to dial

By default, the mobile telephone number (m) of a contact is dialed when you make a call from **Contacts**; however, you can choose to dial a different phone number.

1. On the Home screen, click **Start > Contacts**.
2. Select the contact.
3. Press **NAVIGATION** left or right. The letter representing the number changes to m (mobile), w (work), or h (home).

**Tip** You may also access the contact list by clicking **Contacts** on the Home screen (simply pressing the right **SOFT KEY**).

### To edit the contact

When you select a contact in the contact list and press **ENTER** to view details and different numbers associated with the contact, you can:

- Edit information associated with the contact by clicking **Menu > Edit**.



- Save the selected contact on your SIM card by clicking **Menu > Save to SIM**.

## Make a call from Call History

1. On the Home screen, click **Start > Call History**.
2. Select a name or number, and press TALK (.

**Tip** On the Call History screen, press ENTER to view details, such as the call type (dialed, missed, or received call), call duration, date, and time. Pressing ENTER again dials the associated number.

## To customize calls by using the Menu

You can select various options in the **Menu** of Call History to customize and filter the calls made, received, or missed:

- **Find Contact:** Find the selected name or number in Contacts.
- **Send Text Message:** Send a text message to the selected name or number.
- **E-mail:** Send an e-mail to the selected name or number.
- **View Timers:** Find the duration of the selected call.
- **Delete:** Remove the selected call or number from Call History.
- **Delete List:** Remove all the calls and numbers from Call History.
- **Save to Contacts:** Save the selected name or number in Contacts.
- **Filter:** Categorize the call or number into various call types.

**Note** You can also save a number in Contacts by clicking **Save** on the Call History screen.

## Make a call from Speed Dial

You can make calls using Speed Dial. To learn how to use Speed Dial, see “Using Speed Dial” in Chapter 8.

## 2.3 Receiving a Call

When you receive a phone call, you have the option to answer it or ignore it.

### To answer an incoming call

- To answer the call, click **Answer**, or press TALK (📞) or any numeric key.
- Open the flip cover.

**Tip** The way to answer an incoming call depends on the setting in Answer Mode. For details, see "Set up the Answer Mode" in Chapter 4.

### To ignore an incoming call

- To ignore the call, click **Ignore**, or press END (📞).

### To end a call

- Press END (📞).
- Close the flip cover.

## 2.4 In-Call Options

Your phone provides various options for managing multiple calls at the same time. You are notified when you have another incoming call, and you have the choice of ignoring or accepting the call. If you are already on a call and accept the new call, you can choose to switch between the two callers, or set up a conference call between all three parties.



### To answer another call

1. Click **Answer** to take the second call and put the first call on hold.
2. To end the second call and return to the first call, press END (📞).

### To switch between calls

- To switch between two calls, click **Swap**.

### To set up a conference call

1. Either put a call on hold and dial a second number, or, answer a second incoming call during a call.
2. Click **Menu > Conference**.

#### Notes

- If the conference connection is successful, the word “Conference” appears at the top of the screen.
- To add additional persons to your conference call, click **Menu > Hold**, enter the phone number, and then click **Resume** to return to the call.
- Not all service providers support conference call. Contact your service provider for details.

### To turn on and off the Speakerphone

The built-in Speakerphone allows you to talk hands-free or lets other people listen to the conversation.

- During a call, click **Menu > Speakerphone On**. The speakerphone icon () appears at the top of the screen.
- To turn off the Speakerphone during the call, click **Menu > Speakerphone Off**.

**Tip** The speakerphone can be toggled on and off by simply pressing and holding TALK () during the call

**Warning!** To avoid damage to your hearing, do not hold your phone against your ear when the Speakerphone is turned on.

### To mute a call

Click **Mute** during a call, so that you can hear the caller but the caller cannot hear you. When the microphone is turned off, the mute icon () appears on the screen. Click **Unmute** to turn on the microphone again.



## 2.5 Additional Dialing Information

### Make an emergency call

- Enter the appropriate emergency number for your locale, and press TALK (📞).

**Tip** Additional emergency numbers may be included in your SIM card. Contact your service provider for details.

### Make an international call

1. Press and hold the **0** key on the keypad until the  sign appears. The  sign replaces the international prefix of the country that you are calling.
2. Enter the full phone number, and press TALK (📞). The full phone number includes country code, area code (without the leading zero, if any), and phone number.

### Insert a pause in a dialing sequence

Some international calls require a pause in the dialing sequence in order for the calls to process successfully.

1. On the Home screen, click **Start > Contacts**.
2. Select the contact entry that contains the phone number into which you want to insert a pause, and press ENTER to open the contact card.
3. Select the desired phone number and click **Menu > Edit**.
4. Position the cursor on the phone number where you want to insert a pause, then click **Menu > Insert Pause**. The letter “p” will appear in the number to indicate where the pause will occur in the dialing sequence.
5. Click **Done**.

## Insert a longer pause in a dialing sequence

Some phone numbers may require a longer pause than the default pause in the dialing sequence. In these cases, you can pause as long as you want, and manually continue the dialing sequence.

1. On the Home screen, click **Start > Contacts**.
2. Select the contact entry that contains the phone number into which you want to insert a longer pause, and press ENTER to open the contact card.
3. Select the desired phone number and click **Menu > Edit**.
4. Position the cursor on the phone number where you want to insert a longer pause, then click **Menu > Insert Wait**. The letter “w” will appear in the number to indicate where the longer pause (wait) will occur in the dialing sequence.
5. Click **Done**.

**Note** When you call a number that contains a longer pause, you must press TALK  to continue dialing.

## SIM Tool Kit (STK)

A SIM card must be inserted in your device in order to use this feature, which allows you to access a range of information services provided by your service provider.

1. On the Home screen, click **Start > SIM Tool Kit (STK)**. A list of provided services appears.
2. To access a service, click the item in the list.



# Chapter 3

## Synchronizing Information and Setting Up E-mail Security

**3.1 About ActiveSync**

**3.2 Setting Up ActiveSync**

**3.3 Synchronizing Information**

**3.4 Synchronizing via Bluetooth**

**3.5 Synchronizing Music and Video**

**3.6 Setting Up E-mail Security**



## 3.1 About ActiveSync

ActiveSync synchronizes information on your phone with information on your PC such as Outlook content. ActiveSync can also synchronize over a wireless or cellular network with Exchange Server if your company or service provider is running Exchange Server with Exchange ActiveSync.

Specifically, you can use ActiveSync to:

- Synchronize information such as Outlook e-mail, contacts, calendar, or tasks information on your phone with your PC, as well as music and video files.
- Synchronize Outlook e-mail, contacts, calendar appointments, and tasks on your phone directly with Exchange Server so that you can stay up to date even when your PC is turned off.
- Copy files between your phone and your PC.
- Select which types of information are synchronized and specify how much information is synchronized. For example, you can choose how many weeks of past calendar appointments to synchronize.
- Add and remove programs on your device. For details, see Chapter 4, “Adding and Removing Programs.”

## 3.2 Setting Up ActiveSync

### To install and set up ActiveSync on the computer

1. Install ActiveSync on your PC, as described on the Windows Mobile™ Getting Started Disc.
2. After Setup completes, the Synchronization Setup Wizard automatically starts when you connect your phone to the PC. The wizard will guide you to create a synchronization relationship between your phone and the computer. Click **Next**.



- Do not select the **Synchronize directly with a server running Microsoft Exchange Server** check box if you will synchronize your device with a computer. Just click **Next**, then skip to step 8.
- If you are going to synchronize your device with Exchange Server, select the **Synchronize directly with a server running Microsoft Exchange Server** check box, then click **Next**.
- On the Exchange server credentials screen, enter the Exchange server address, your user name and password, and the domain name.



If you do not know what the Exchange server address and domain name are, you can check with your network administrator, or you can check them in your computer by doing the following:

- In Outlook, click **Tools > E-mail Accounts**.
- Select **View or change existing e-mail accounts**.
- Double-click **Microsoft Exchange Server**.
- On the Exchange Server Settings screen, you will see the Exchange Server name.

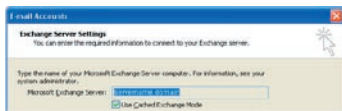

## 42 Synchronizing Information and Setting Up E-mail Security

- To check the domain name, click **Start > Settings > Control Panel**, then double-click **System**.
- In the System Properties dialog box, click the **Computer Name** tab. You will then see the domain name.

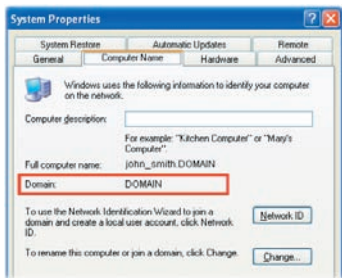

6. On your device, you also need to enter the Exchange server settings. For information about this, see “Synchronizing directly with Exchange Server.”
7. On the Synchronization Setup Wizard, click **Next**.
8. Select the information types to synchronize between your device and the computer.

If you are going to synchronize your device with both your computer and Exchange Server, do the following:

- For the Contacts, Calendar, E-mail, and Tasks items, choose whether to synchronize them with the computer or with the Exchange Server. These items cannot be synchronized to both.
  - Select the check boxes of the other information types if you want to synchronize them with your computer.
9. Click **Next**.
  10. Click **Finish**.

**Tip** When you finish the wizard, ActiveSync synchronizes your phone automatically. Once synchronization completes, you can disconnect your phone from your PC.

## 3.3 Synchronizing Information

When you connect your phone to the PC, ActiveSync will immediately synchronize. While the phone is connected, ActiveSync synchronizes every time you make a change on either the PC or the phone.

### To manually start and stop synchronization

1. Connect your phone.
  - To synchronize local information on the PC, such as Outlook information or media files, connect your phone to the PC using Bluetooth or a cable.
  - If you are synchronizing directly with Exchange Server, you can use the connection to the PC to access the network, or you can synchronize over a cellular connection without connecting to the PC.
2. In ActiveSync, click **Sync**. To end synchronization before it completes, click **Stop**.

### Synchronize Outlook information with the computer

If you have set up a synchronization relationship between your phone and the PC, synchronization keeps Outlook information up-to-date on both of them.

You can also set up your phone to synchronize with more than one PC, or with a combination of one or more PCs and Exchange Server. When synchronizing with multiple computers, the items you synchronize will appear on all of the computers with which they are synchronized. For example, if you have set up synchronization with two PCs (PC1 and PC2), which have different items, and you synchronize Contacts and Calendar on the phone with both computers, the result is as follows:

Location	New state
<b>PC1</b>	All Outlook contacts and calendar appointments that were on PC2 are now also on PC1.
<b>PC2</b>	All Outlook contacts and calendar appointments that were on PC1 are now also on PC2.
<b>Phone</b>	All Outlook contacts and calendar appointments from both PC1 and PC2 are on the phone.

**Note** Outlook e-mail can be synchronized with only one computer.

### To change which information is synchronized

ActiveSync synchronizes a limited amount of information by default to save storage space on your phone. You can change the amount of information that is synchronized by performing the following steps.

**Note** Before changing synchronization settings on the phone, disconnect it from your PC.

1. On the Home screen, click **Start > ActiveSync**.
2. In ActiveSync, click **Menu > Options**.
3. Do one or more of the following:

- Select the check box for the items you want to synchronize. If you cannot select a check box, you might have to clear the check box for the same information type elsewhere in the list.
- Clear the check box for any items you want to exclude.
- To customize synchronization of a computer, select the computer name then click **Menu > Settings**.
- To customize synchronization of a particular information, select the information type then click **Settings**.
- To stop synchronizing with one computer completely, select the computer name and click **Menu > Delete**.

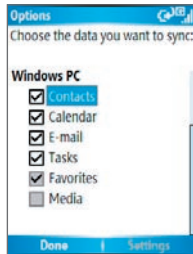

**Note** Outlook e-mail can be synchronized with only one computer.

## Synchronize Outlook information with Exchange Server

You can set up synchronization with Exchange Server on your phone, if it is available to you through your company or wireless service provider. However, you should first ask your administrator or check your computer for the following information and then carry on with the steps: Exchange Server name, domain name, your user name, and password. (For information about how to check the Exchange server name and domain on your PC, see “To install and set up ActiveSync on the computer.”)

**Note** Before changing synchronization settings on the phone, disconnect it from your PC.

### To synchronize directly with Exchange Server

1. On the Home screen, click **Start > ActiveSync > Menu > Configure Server**. If you have not yet set up synchronization with Exchange Server, this will say **Add Server Source**.
2. On the Edit Server Settings screen, enter the name of the server running Exchange Server in the **Server address** box, and click **Next**.
3. On the User Information screen, enter your user name, password, and domain name.
4. If you want the phone to save your password so that you will not need to enter it again when connecting, select the **Save password** check box. Then, click **Next**.
5. On the Options screen, select the check boxes of the types of information that you want to synchronize with Exchange Server.
6. To customize synchronization of a particular information, select the type of information then click **Menu > Settings**.
7. To change the rules for resolving synchronization conflicts, click **Menu > Advanced** on the Options screen.
8. Click **Finish**.

**Note** You can also use the Sync Setup Wizard to set up the phone to synchronize remotely with Exchange Server. This wizard is started when you connect your phone to your PC after installing ActiveSync on the PC.

## Schedule synchronization with Exchange Server

You can schedule information to be synchronized automatically between your phone and Exchange Server, or schedule synchronization at regular time intervals. Choose between these two methods, depending on your e-mail volume and which method you think is more cost-effective.

### To receive e-mails and synchronize other information instantly

The **Direct Push** technology (Push E-Mail feature) enables you to receive new e-mails on your phone as soon as they arrive in your Inbox on Exchange Server. With this feature, items such as contacts, calendar and tasks are also immediately updated onto your phone when these items have been changed or new entries have been added on Exchange Server. To make Direct Push work, you need to set up a GPRS connection on your phone.

The Direct Push feature works for your phone, if your private network such as your corporate network is using Microsoft Exchange Server Service Pack 2 (SP2) with Exchange ActiveSync, and after your first full synchronization with Exchange Server.

1. In ActiveSync on your phone, click **Menu > Schedule**.
2. Select **As items arrive** in the **Peak times** and **Off-peak times** boxes.

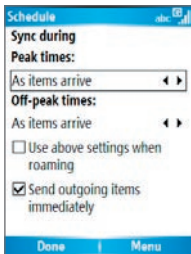
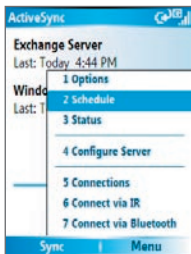

### To schedule synchronization at regular time intervals

You can set how often to synchronize during **Peak times** (which usually refer to your working hours) when e-mail volume is high, as well as **Off-times** when e-mail volume is low.

1. In ActiveSync on your device, click **Menu > Schedule**.
2. On the Schedule screen, select a shorter time interval in the **Peak times** box for you to be able to receive e-mails more frequently.
3. Select a longer interval in the **Off-peak times** box.

**Tip** To set the days and hours that make up your peak and off-peak times, click **Menu > Peak Times** on the Schedule screen.

## 3.4 Synchronizing via Bluetooth

You can connect your phone to the PC to synchronize using Bluetooth. This technology has similar but slightly different requirements.

### To synchronize with a PC via Bluetooth

1. Follow the instructions in ActiveSync Help on the PC for configuring Bluetooth on your PC to support ActiveSync.
2. On the Home screen, click **Start > ActiveSync**.
3. Click **Menu > Connect via Bluetooth**. Ensure that the phone and the PC are within close range.
4. If this is the first time you have connected to this PC via Bluetooth, you must complete the Bluetooth wizard on the phone and set up a Bluetooth partnership with the PC before synchronizing.
5. Click **Sync**.
6. When finished, click **Menu > Disconnect Bluetooth**.

### Notes

- To preserve battery power, turn off Bluetooth when not in use.
- To connect and synchronize your phone with a computer via Bluetooth, your computer must have a Bluetooth adapter or dongle.

## 3.5 Synchronizing Music and Video

If you want to take your music or other digital media with you, ActiveSync works with Windows Media Player to synchronize music and video files with your phone.

Other than selecting the media information type in ActiveSync to be synchronized, all media synchronization settings must be set in Windows Media Player. Before media can be synchronized, you must do the following:

- Install Windows Media Player Version 10 on the PC.
- Connect your phone to the PC with a USB cable. If the phone is currently connected using Bluetooth, you must end that connection before media can be synchronized.
- Insert a 32-MB or larger storage card into your phone.
- Set up a sync partnership between the storage card and Windows Media Player.

### Change Media synchronization settings

Once you select the Media information type in ActiveSync to be synchronized, any of your favorite music and video files in Windows Media Player playlists can be synchronized by ActiveSync. All you have to do is set up synchronization in Windows Media Player for those media files.

#### To set up a sync relationship with a storage card

1. On the PC, open Windows Media Player.
2. Click the **Sync** tab.
3. Select the storage card.
4. Click **Set up Sync**.
5. Choose whether to synchronize automatically or manually.

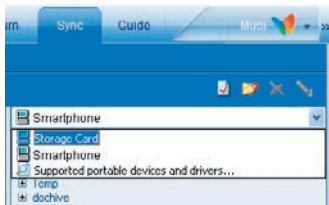

For information about using Windows Media Player on the phone, see “Using Windows Media Player” in Chapter 7.



## 3.6 Setting Up E-mail Security

Windows Mobile on your phone protects your Outlook e-mails through Secure/Multipurpose Internet Mail Extension (S/MIME), which allows you to digitally sign your messages as well as encrypt them.

Using authorization keys and certificates, S/MIME allows you to digitally sign your e-mail messages to prove your identity to the recipients. Authorization keys are also used when encrypting messages to improve privacy and prevent undue tampering or hacking of your messages. You can encrypt a message with or without a certificate. However, to read an encrypted message, you need a valid certificate for decrypting e-mail messages.

**Note** S/MIME encryption and digital signatures for Windows Mobile-based devices are available only with Exchange Server 2003 Service Pack 2 or a later version that supports S/MIME. If you aren't using one of these products, or have not yet synchronized, these options are unavailable.

### Digitally sign and encrypt all messages

ActiveSync allows you to set up S/MIME e-mail encryption and signing. You will have to obtain a valid certificate for signing or encrypting e-mail before you will be able to sign or encrypt mail successfully.

1. On the Home screen, click **Start > ActiveSync**.
2. Click **Menu > Options**.
3. Select the **E-mail** information type, and click **Settings**. On the E-mail Sync screen, click **Menu > Advanced**.

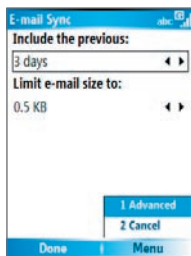
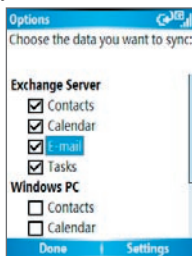

4. Do one or both of the following:
  - To sign all your outgoing e-mail messages so that recipients can be certain that the messages were sent by you and have not been altered in any way, select **Sign messages**.
  - To encrypt all your outgoing e-mail messages so that the contents of your messages are protected from being viewed by anyone other than the intended recipients, select **Encrypt messages**.
5. Click **Menu > Choose Certificate** to select a certificate for signing or encrypting outgoing e-mail messages.

You can select certificates to sign or encrypt e-mail messages individually if you do not choose to sign or encrypt all outgoing e-mails. For information about signing and encrypting individual messages, see “Individually sign and encrypt a message” in Chapter 6.

# Chapter 4

## Managing your Phone

- 4.1 Personalizing your Phone**
- 4.2 Adding and Removing Programs**
- 4.3 Using Task Manager and Managing Memory**
- 4.4 Managing and Backing Up Files**
- 4.5 Protecting your Phone**
- 4.6 Restarting your Phone**
- 4.7 Resetting your Phone**

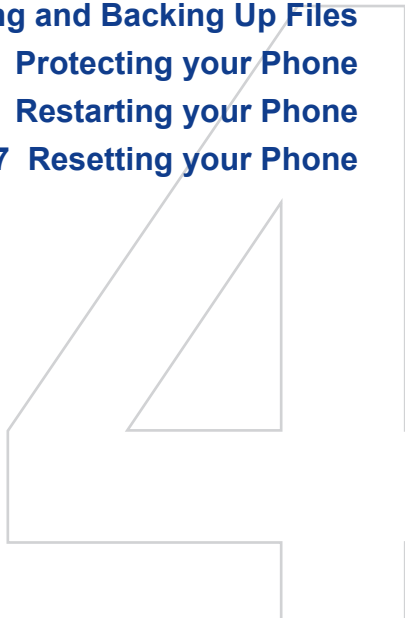

## 4.1 Personalizing your Phone

### Set up the Answer Mode

You can answer an incoming call by pressing TALK (📞) or any numeric key on the keypad, or simply by opening the flip cover.

1. On the Home screen, click **Start > Settings > Phone**.
2. Click **Answer Mode**.
3. Select **Open to answer** or **Any key to answer**.

### Set up the Home screen

The Home screen is your starting place for most tasks. You can gain access to all features and programs from the Home screen.

The top of the Home screen displays icons for the programs that you have most recently used. The center of the Home screen can display your next appointment, the number of new messages (voice mail, text, e-mail, or MMS) that you have received, and other important information. When you click an icon or item on the Home Screen, the associated program opens.

#### To customize the Home screen

1. On the Home screen, click **Start > Settings > Home Screen**.
2. In **Home screen layout**, **Color scheme**, **Background image**, and **Time out**, select the options you want, and click **Done**.

**Tip** You have three ways to set up the background image:

- Use ActiveSync to copy your favorite picture file to the directory in your phone: My Device\Application Data\Home. Then, you can select the picture as the background image through **Start > Settings > Home Screen > Background image**.
- Capture a photo using the phone's camera. When viewing the photo in the Review screen, click **Menu > Use as Home Screen** and then follow the on-screen instructions to set the captured photo as the background image.
- Use the Pictures & Videos program to set up the background image. See "To set a picture as the Home screen background" in Chapter 7 for details.

## Set language, locale, and other regional options

Your phone should already be set up with the regional settings that are appropriate for your locale.

### To change regional settings

You can specify the language, locale, date and time style, as well as number and currency formatting options.

1. On the Home screen, click **Start > Settings > Regional Settings**.
2. In **Language**, select your preferred language.
3. In **Locale**, select the locale for the language you selected. The Locale option automatically changes the format of the remaining options (such as date, time, and currency) according to the locale you specify.
4. Click **Done**.

**Note** You must turn your phone off and on again for the changes to take effect.

## Set the date and time

1. On the Home screen, click **Start > Settings > Clock & Alarm > Date and Time**.
2. In **Time zone**, select your time zone.
3. In **Date**, edit the month, day, or year.
4. In **Time**, edit the hour, minute, and second.
5. Click **Done**.

## Choose how to be notified about events or actions

A profile is a group of settings that determine how your phone will alert you to incoming calls, events such as e-mail receipt notifications, alarms, or system events. A number of different preset combinations of these settings are included with your phone. Each profile appears with a descriptive name.

### To change the current profile

1. On the Home screen, click **Profile [Type]**. Example: **Profile Normal**.
2. Select the desired profile and click **Done**.

**Tip** To quickly change the profile, press and hold the HOME button to display the Quick List, and click a profile.

### To edit a profile

1. On the Home screen, click **Profile [Type]**. Example: **Profile Normal**.
2. Select the profile to edit.
3. Click **Menu > Edit**.
4. Do one of the following:
  - Modify the settings, and click **Done**.
  - To cancel without saving changes, click **Cancel**.

**Tip** To revert to the default profile settings, click **Menu > Reset to default**.

### To specify the sound for an event

1. On the Home screen, click **Start > Settings > Sounds**.
2. For the desired event, select a sound. Select **None** if you do not want to hear a sound.
3. Click **Done**.

**Note** For ring tones, you can use sounds in either .wav, .mid, .wma, or .mp3 file format. For notifications or reminders, you can use .wav, or .mid files.

**Tip** When you select a sound, the sound plays. To hear it again, select **Menu > Play**.

### To set sound for the keypad

1. On the Home screen, click **Start > Settings > Sounds**.
2. In **Keypad control**, select a sound. Select **None** if you do not want to hear any sound while pressing a key.
3. Click **Done**.

## To copy a sound to your phone

After a sound file is located on your phone, you can use it for a ring tone, notification, or reminder. Sound files in either .wav, .mid, .wma or .mp3 formats can be used.

1. Connect the phone to your PC using a USB connection.
2. On your PC, copy the desired sound file.
3. In ActiveSync on your PC, click **Explore** and double-click **My Windows Mobile-Based Device**.
4. Do one of the following:
  - To save the sound file on your phone, double-click **Application Data**, double-click **Sounds**, and paste the file into that folder.
  - To save the sound file on your storage card, double-click **Storage Card**, and paste the file into the folder you want.

## To set an alarm

1. On the Home screen, click **Start > Settings > Clock & Alarm > Alarm**.
2. In **Alarm**, choose one of the following:
  - **Off** to turn the alarm off.
  - **On** to turn the alarm on.
3. In **Alarm time**, enter the time for the alarm to go off.
4. Click **Done**.

## Set personal information

Entering and displaying owner information are best practices; they allow someone to return the phone to you in case it is lost.

### To enter owner information

1. On the Home screen, click **Start > Settings > Owner Information**.
2. Complete the following:
  - In **Name**, enter your name.

- In **Telephone number**, enter a number where you can be reached.
  - In **E-mail address**, enter your e-mail address.
  - In **Notes**, enter any other information you want to include.
3. Click **Done**.

## Set performance and maintenance options

### To change accessibility settings

1. On the Home screen, click **Start > Settings > Accessibility**.
2. Select your preference for the following:
  - **System font size** to set the size of the font that is displayed on the screen.
  - **Multipress time out** to set the length of time between keypresses when entering text in Multipress mode.
  - **Confirmation time out** to set the delay before an unconfirmed action times out.
  - **In-call alert volume** to set the volume for incoming call or receiving new message alerts while you are in a call.
3. Click **Done**.

### To change power management settings

You can use Power Management to check the battery, and configure settings that prolong battery life.

1. On the Home screen, click **Start > Settings > Power Management**.
2. Adjust the following:
  - In **Backlight time out on battery**, select the amount of time for the phone to be idle before the backlight turns off.
  - In **Backlight time out on AC**, select the amount of time for the phone to be idle before the backlight turns off when using AC power.



- In **Display time out**, select the time limit for the phone to be idle before the screen turns off.
- In **Light Sensor Enable**, turn it on to see the buttons on the keypad more easily in the dark.

3. Click **Done**.

**Tip** **Main battery** indicates the amount of battery life remaining.

### To find the operating system version number

- On the Home screen, click **Start > Settings > About**.  
The operating system version number installed on your phone along with the manufacturer copyright information will be listed on the screen.

### To find the phone specification

- On the Home screen, click **Start > Settings > System Information**.  
The System Information screen displays the details about the phone specification, such as processor, speed, memory, display, model name, and so on.

### To turn on and off error reporting

1. On the Home screen, click **Start > Settings > Error Reporting**.
2. In **Error Reporting**, select **Enable** or **Disable** to turn on or off error reporting.
3. Click **Done**.

## Set up the external screen

You can change the display of the external screen when the flip cover is closed.

On the Home screen, click **Start > Settings > External Screen**, then you can configure the following:

- **Background**. Select the different type of clock shown on the external. Selecting Wallpaper allows you to choose a picture as the background of the external screen.

- **Wallpaper image.** Select a picture as the wallpaper.
- **Status bar.** Select **On** or **Off** to show or hide the status bar on the external screen.
- **Date and time.** Select **On** or **Off** to show or hide the current date and time on the external screen.
- **Button lock after idle for.** Select the amount of time for the phone to be idle before the buttons are locked.
- **Button lock after closing.** Selecting **On** means the buttons will be locked immediately after the flip cover is closed. When you select **Off**, the buttons lock function will activate according to the configuration in the **Button lock after idle for** item.
- **Display time out.** Select the time limit for the phone to be idle before the external screen turns off.
- **Display on after closing.** Selecting **Off** means the external screen will turn off immediately after the flip cover is closed. When you select **On**, the display time depends on the setting in the **Display time out** item.

## 4.2 Adding and Removing Programs

Before you purchase additional programs for your phone, you should note the name of your phone, the version of Windows Mobile software running on it, and the type of processor. This information will help you select a program that is compatible with your phone. For more information, see “To find the operating system version number” in this chapter.

Programs available for purchase usually include a Setup program (commonly named “setup.exe”) that you must first install on your PC. You can then use ActiveSync to add programs to your phone or add a program directly from the Internet.

## To add programs

1. Download the program to your PC (or insert the CD or disk that contains the program into your PC). You may see a single \*.exe file, a \*.zip file, a Setup.exe file, or several versions of files for different device types and processors. Be sure to select a program designed for your phone and processor type.
2. Read any installation instructions or documentation that comes with the program. Many programs provide special installation instructions.
3. Connect your phone and PC.
4. Double-click the \*.exe file.
  - If the executable file is an installation wizard, follow the instructions on the screen. Once the program has been installed on your PC, the wizard will automatically transfer the program to your phone.
  - If an installation wizard does not start, you will see an error message stating that the program is valid but that it is designed for a different type of computer. You will need to copy this program to your phone. If you cannot find any installation instructions for the program, use ActiveSync to copy the program file to the Program Files folder on your phone.

## To remove a program

Programs that come with the phone cannot be removed.

1. On the Home screen, click **Start > Settings > Remove Programs**.
2. Scroll to the program to remove.
3. Click **Menu > Remove**.

## 4.3 Using Task Manager and Managing Memory

### To see how much memory is available

1. On the Home screen, click **Start > Settings > About**.
2. Scroll down to **Available Memory**.

### Use Task Manager

Task Manager allows you to view all the programs currently running on your phone in the form of a list. From Task Manager, you can switch to, activate, or terminate any currently running program. It also allows you to view the phone memory status and battery information.

### To start Task Manager

- Click **Start > Task Manager**.

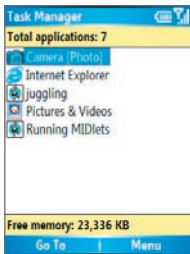

Task Manager

The Task Manager Menu contains the following options.

Option	Allows you to
<b>Go To</b>	Switch to the selected program.
<b>Refresh</b>	Refresh the Task Manager screen to reflect a list of currently running programs.
<b>Stop</b>	Stop the selected program. You can view the free memory status at the bottom of the screen.

Option	Allows you to
<b>Stop All</b>	Stop all listed programs. Click <b>OK</b> to confirm that you want to end all currently running programs. You can view the free memory status at the bottom of the screen.
<b>Stop All But Selected</b>	Stop all running programs in the list except the one you selected.
<b>System Info</b>	View information about power status, memory usage, flash, and device information.
<b>About</b>	View program name, version, and copyright information.

## 4.4 Managing and Backing Up Files

You can back up files to your PC using ActiveSync or copy files to a storage card that is installed by you on your phone. You can also efficiently manage your files and folders using File Explorer installed on your phone.

Using Microsoft ActiveSync, you can copy or move information from the PC to the phone and vice versa. Changes you make to the information on one computer will not affect the information on the other computer. If you want to automatically update information on both your phone and PC, synchronize the information instead. For more information about copying and synchronizing files, see ActiveSync Help on your PC.

### To copy a file using ActiveSync

Copying a file results in separate versions of a file on your phone and PC. Because the files are not synchronized, changes made to one file will not affect the other.

1. Connect your phone to your PC.
2. In ActiveSync, click **Explore**, which opens the Mobile Device folder for your phone.
3. In the Mobile Device folder, go to the file that you want to copy on your phone or PC.

4. Do one of the following:

- To copy the file to your phone, right-click the file, and click **Copy**. Right-click the desired folder on your phone, and click **Paste**.
- To copy the file to your PC, right-click the file and click **Copy**. Right-click the desired folder on your PC, and click **Paste**.

## Use File Explorer

File Explorer provides many easy-to-use features for file and folder management.

### To start File Explorer

- On the Home screen, click **Start > File Explorer**.

File Explorer operates in the following two views:

- List View
- Icons View

File Explorer displays the entire file structure in your phone's memory. The functions focus primarily on folder management. When initially started, File Explorer is in List View by default. To switch between views, click **Menu > View > Icons** or **List**.

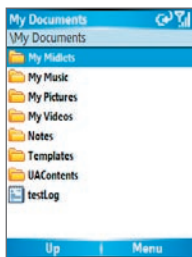

File Explorer - List View

The File Explorer menu contains the following options:

Option	Allows you to
<b>Send</b>	Lets you send the selected file through one of the messaging features.
<b>Beam</b>	Lets you send the selected file through Bluetooth.
<b>Edit</b>	Opens a menu where you can choose to cut, copy, paste, delete or rename a file. You can also create a new folder.
<b>Properties</b>	View information about the selected folder or file.
<b>View</b>	Opens a menu where you can switch between the Icons or List view.
<b>Sort By</b>	Opens a menu where you can choose to sort the files or folders by Name, Date, Size or Type.
<b>My Device</b>	Displays the folders and files in the root folder of the phone.
<b>My Documents</b>	Displays the folders and files in the My Documents folder.

### To send a file as an e-mail attachment

1. In File Explorer, select a file.
2. Click **Menu > Send**.
3. On the Messaging screen, select **Outlook E-mail** or a custom e-mail account.
4. The file will automatically be attached to the new message. Specify the recipient and subject, and type your message.
5. Click **Send**.

## 4.5 Protecting your iPhone

There are several levels of security on your iPhone. You can protect your iPhone from unauthorized use by requiring a type of password called a PIN (personal identification number) in order to make calls. Your first PIN will be given to you by your wireless service provider. Additionally, you can lock the keypad or the entire iPhone to prevent unauthorized access.

### To enable the SIM personal Identification number (PIN)

1. On the Home screen, click **Start > Settings > Security**.
2. Click **Enable SIM PIN**.
3. Enter your PIN, and click **Done**.

**Note** To cancel without enabling the SIM PIN, press HOME.

### To disable the SIM PIN

1. On the Home screen, click **Start > Settings > Security**.
2. Click **Disable SIM PIN**.
3. Enter your PIN, and click **Done**.

### To change the SIM PIN

Be sure to make a note of your personal identification number (PIN). When the SIM PIN is enabled, you must provide this PIN to unlock the phone.

1. Click **Start > Settings > Security**.
2. Click **Change SIM PIN**.
3. In **Old PIN**, enter the current PIN.
4. Enter and confirm the new PIN, and click **Done**.

## Lock the keypad

Locking the keypad turns off keypad functionality. This is a helpful feature if, for example, the iPhone is turned on and in your pocket, and you want to prevent accidental keypresses.



### To lock the keypad

- On the Home screen, press and hold the HOME button, and click **Key lock**. Once the keypad is locked, the left soft key label changes to **Unlock**.

**Note** You can still receive calls and make emergency calls when the keypad is locked.

### To unlock the keypad

- On the Home screen, click **Unlock** and press the  key.

## Lock your phone

Device Lock is an additional security feature that prevents unauthorized use of your phone.

### To enable/disable Device Lock

1. On the Home screen, click **Start > Settings > Security**.
2. Click **Device Lock**.
3. Select the **Prompt if device unused for** item, then select the amount of time for the phone to be inactive before automatically locking.
4. Select the password type (**Simple SIM** or **Strong alphanumeric**).
5. Enter and confirm your password.
6. Click **Done**.
7. To disable Device Lock, click **Start > Settings > Security > Device Lock** to enter the setting page (require the password) and clear the **Prompt if device unused for** item.

### To lock/unlock your phone

- Once you configure the Device Lock setting, you can lock your phone from the Quick List directly without configuring the settings again.
- When the device is locked, click **Unlock** and enter the password to unlock your device.

## 4.6 Restarting your Phone

Occasionally, you may want to restart your phone, for example, when a program is not performing properly or the phone does not respond to any keypresses.

### To restart the phone

1. Remove the battery.
2. Reinsert the battery and turn on your phone.

**Warning!** If the phone is restarted while a program is running, unsaved work will be lost.

## 4.7 Resetting your Phone

Resetting your phone will remove all the data from its memory which include contacts, tasks, calendar appointments, and more, and restore the phone back to the factory default settings.

### To reset your phone

1. Click **Start > Accessories > Clear Storage**.
2. Follow the on-screen instructions to reset the phone. The phone will restart after it has been reset.

# Chapter 5

## Getting Connected

**5.1 Connecting to the Internet**

**5.2 Using Internet Explorer Mobile**

**5.3 Using Wireless Modem**

**5.4 Using Comm Manager**

**5.5 Using Bluetooth**



## 5.1 Connecting to the Internet

Your phone's powerful networking capabilities allow you to access the Internet or your corporate network at work through wireless and conventional connections. Specifically, you can configure your phone to establish a connection via Dial-up, GPRS, Bluetooth, Virtual Private Network (VPN), or Proxy.

With an active connection on your phone, you can browse the Web, download e-mails, or chat using MSN Messenger. Check with your service provider to see if a connection has already been set up for you, and if over-the-air configuration is supported.

If you need to manually set up a connection, it is important that you obtain the following information from your Internet Service Provider (ISP) or the company whose intranet you are trying to access:

- ISP server phone number
- User name
- Password
- Access point name (required for GPRS connection)
- Domain name (required for accessing a corporate network or an intranet)

### Set up a GPRS connection

GPRS is a non-voice value-added service that allows information to be sent and received across a mobile telephone network. You can use GPRS to connect to the Internet or to send and receive MMS on your phone. When you use GPRS, you will be billed per KB (Kilobyte) when sending or receiving information.

Check with your service provider for details on billing of your data plan.

If GPRS settings are not preset on your phone, obtain the **Access point name** from your wireless service provider. Also, check with your wireless service provider if a user name and password are required.

## To set up a GPRS connection

1. On the Home screen, click **Start > Settings > Connections > GPRS**.
2. Click **Menu > Add**.
3. In **Description**, enter a name for the connection.
4. In **Connects to**, select **The Internet**.
5. Enter the name of the GPRS **Access point** of your wireless service provider.
6. Enter the appropriate information in the remaining fields, if required by your wireless service provider.

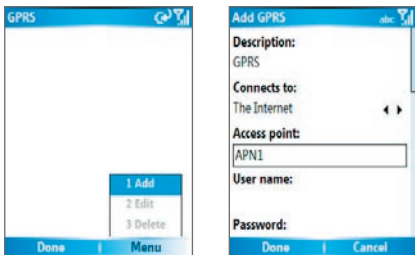

7. Click **Done**.
8. To start browsing the Internet, click **Start > Internet Explorer**.

**Note** For information about setting up and sending MMS, see “Using MMS Messages” in Chapter 6.

## Set up a Dial-up connection

When you use your phone to dial up to your ISP and connect to the Internet or to your corporate network, you will be billed by the number of minutes that you use.

To establish a dial-up connection on your phone, you need the same settings that you normally use when you dial up from your computer. This includes the ISP server phone number, your user name and password.

**To set up a dial-up connection for browsing the Internet**

1. On the Home screen, click **Start > Settings > Connections > Dial-up**.
2. Click **Menu > Add**.
3. In **Description**, enter a name for the connection.
4. In **Connects to**, select **The Internet**.
5. Enter the appropriate information in the remaining fields.

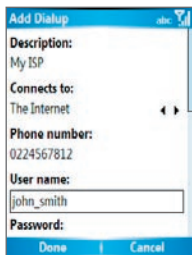

6. Click **Done**.
7. To start browsing the Internet, click **Start > Internet Explorer**.

**To set up a dial-up connection to your corporate network**

1. On the Home screen, click **Start > Settings > Connections > Dial-up**.
2. Click **Menu > Add**.
3. In **Description**, enter a name for the connection.
4. In **Connects to**, select **Work**.
5. Enter the appropriate information in the remaining fields.
6. Click **Done**.

**Note**

You can also add and set up the following connections:

- **VPN:** A VPN connection is used to access your corporate network by using an existing Internet connection.
- **Proxy:** A Proxy connection is used to access the Internet using an existing connection to your corporate or WAP network.

## Advanced options

From the Connections screen, you can access advanced options to specify the service provider, the number of redial attempts, the amount of idle time to wait before disconnecting, and so on.

1. On the Home screen, click **Start > Settings > Connections**.
2. Click **Menu > Advanced**.
3. Select a network service provider for each connection type. You can choose **Automatic** to allow the phone to set a service provider for each connection by default.
4. Click **Menu > Options**.
5. Choose the appropriate information in the remaining fields.
6. Click **Done**.

## Add a URL exception

Some URLs for Web pages on your company intranet may use periods, for example: intranet.companyname.com. To view these pages in Internet Explorer Mobile, you must create a URL exception.

1. On the Home screen, click **Start > Settings > Connections**.
2. Click **Menu > Advanced**.
3. Click **Menu > Work URL Exceptions**.
4. Click **Menu > Add**.
5. In **URL Pattern**, enter the URL name. To add multiple URLs, use a semicolon (;).
6. Click **Done**.

**Note** You do not need to create URL exceptions for Internet URLs.

## 5.2 Using Internet Explorer Mobile

Internet Explorer Mobile is a full-featured Internet browser, optimized for use on your phone.

### To open Internet Explorer

- On the Home screen, click **Start > Internet Explorer**.

### To go to a link

1. While on a Web page, scroll vertically or horizontally to see all available links.
2. Click the link.

### To go to a Web page

1. In Internet Explorer, click **Menu > Address Bar**.
2. Enter the address, and click **Go**.

### To change Web page display options

1. While on a Web page, click **Menu > View**.
2. Select one of the following:
  - **One Column.** Arranges the content into one column that is as wide as the screen. This means that you will rarely have to scroll horizontally.
  - **Default.** Maintains a layout similar to what you see on a desktop computer, but makes items smaller and arranges the content so that you can see most of it without having to scroll horizontally.
  - **Desktop.** Keeps the same layout and size as on a desktop computer, which will require both horizontal and vertical scrolling.

### To change the size of text on Web pages

- While on a Web page, click **Menu > Zoom** and select the size you want.



### To show or hide pictures on Web pages

- While on a Web page, click **Menu > View > Show Pictures**.  
A check mark next to **Show Pictures** indicates that pictures will be displayed on Web pages.

### To view a page in full-screen mode

- While on a Web page, click **Menu > View > Full Screen**.

**Tip** To exit full-screen mode, press either **SOFT KEY**, and then click **Menu > View > Full Screen** to cancel the selection.

### To add a Web page to the Favorites list

1. To go to the page you want to add, click **Menu > Address Bar**, enter the address, and click **Go**.
2. Click **Menu > Add to Favorites**.
3. Confirm or change the name and Web page address.
4. In **Folder**, select a folder for the favorite.
5. Click **Add**.

**Tip** A quick way to add favorites to your phone is to synchronize with your PC using ActiveSync. For more information, see ActiveSync Help on your PC.

### To view a favorite

1. While on a Web page, click **Favorites**.
2. Select a favorite, and click **Go**.

### To move a favorite to a folder

1. Click **Favorites**.
2. Select the favorite to move.
3. Click **Menu > Edit**.
4. Under **Folder**, scroll to the folder to which you want to move the favorite.
5. Click **Done**.

### To clear history, cookies, or temporary files

1. While on a Web page, click **Menu > Tools > Options**.
2. Click **Memory**.
3. Select the type of memory to clear.
4. Click **Clear**, click **Yes**, and then click **Done**.

### To send a link via e-mail

1. Go to the desired Web page.
2. Click **Menu > Tools > Send Link via E-mail**.
3. Select **Text Messages** or **Outlook E-mail**.
4. A new message is created with the page address inserted in the message body.

## 5.3 Using Wireless Modem

With **Wireless Modem**, you can use your phone as an external modem for another device such as a PDA or notebook computer.

**Note** Make sure your phone has a GPRS SIM card installed, and you have set up a GPRS or dial-up modem connection on your phone. For information about setting up GPRS on your phone, see “Set up a GPRS connection” in this chapter. Also make sure you have connected your phone to a computer (via Bluetooth or USB). For information about setting up a dial-up connection, see “Set up a Dial-up connection.”

### Set up the phone as a modem

#### To set up the phone as a USB modem

1. On the Home screen of your phone, click **Start > Accessories > Wireless Modem**.
2. Select **USB** as the **Connection** type.
3. To use your phone as a GPRS modem, set the **Access point name (APN)**. To set, click **Menu > APN Setting** and enter the access point name.

4. On your notebook, disable ActiveSync. Then plug in the USB cable adapter between the phone and the notebook.

**Note** To disable ActiveSync on your computer, click **File > Connection Settings** then clear **Allow USB connections**.

5. Click **Menu > Start** on your phone.
6. The next thing to do is to add the phone as a USB modem onto your notebook. To do so, continue to do the following steps.
7. After you click **Menu > Start** on the Wireless Modem screen of your phone, your notebook will automatically detect that your phone has been connected. The Found New Hardware dialog box will then appear on your notebook.
8. In the Found New Hardware dialog box, select **Install from a list or specific location (Advanced)** and click **Next**.
9. Select **Search for the best drivers in these locations**.
10. Insert the Getting Started Disc into your CD drive. Select the **Include this location in the search** check box, then click **Browse** and choose the CD drive and root folder where the modem driver is located. Then click **Next**.
11. Wait for the installation to complete, then click **Finish**.
12. On your computer, click **Start > Settings > Control Panel**.
13. Double-click **Phone and Modem Options**.
14. Click the **Modems** tab. Select the new modem from the Modems list, then click **OK**.

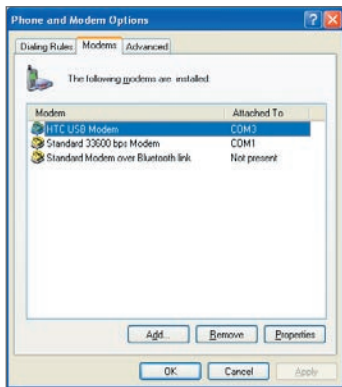

### To set up the phone as a Bluetooth modem

You can connect your phone to a computer through Bluetooth and use the phone as a modem for the computer.

To learn how to set up the phone as a Bluetooth modem, see “Use the phone as a Bluetooth modem” in this chapter.

## Dial-up and connect to the Internet

Once the notebook recognizes your phone as a modem, you can now set up a dial-up connection. You will then be able to access the Internet on your notebook using your phone.

### To dial-up and connect to the Internet

1. On your notebook, click **Start > Settings > Control Panel**.
2. Double-click **Network Connections**.
3. Click **File > New Connection**.
4. In the New Connection Wizard, click **Next**.
5. Click **Connect to the Internet**, then click **Next**.
6. Select **Set up my connection manually** and then click **Next**.
7. Select **Connect using a dial-up modem** and then click **Next**.
8. Select the modem that you previously installed, then click **Next**.
9. Enter a descriptive name for your ISP, then click **Next**.
10. If you are connecting to the Internet via GPRS, enter the telephone number as \*99#. Otherwise, enter your ISP's dial-up phone number and then click **Next**.
11. Under Internet Account Information, you may not need to enter a user name and password when using GPRS. Just click **Next** to proceed.
12. Click **Finish** to exit the wizard.

13. The Connect dialog box then opens. Click **Dial** to dial up and connect to the Internet.



Next time you want to dial up again from your computer, click **Start > Settings > Control Panel**, double-click **Network Connections**, then double-click the modem connection.

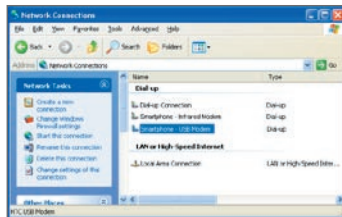

- Note** To dial up to the Internet, you can also use the dialer program, `USBModem_Dialer.exe`, which is included in the Getting Started Disc. Follow the below directory: `\OEM\APPS\Drivers\GSM USB Modem` directory to find the file.

### To end the modem session

- On the Wireless Modem screen, click **Menu > Stop**.

## 5.4 Using Comm Manager

**Comm Manager** acts like a central switcher that lets you enable or disable phone features as well as manage your data connections easily.

### To open Comm Manager:

- Click **Start > Comm Manager**.
- If you are at the Home Screen, simply highlight the area where the Operator name is shown and click.

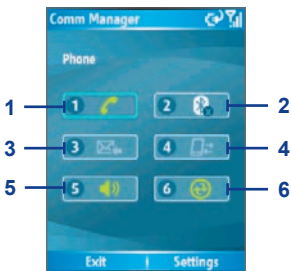

Comm Manager

1. Click to toggle between enabling and disabling the phone.
2. Click to toggle between turning on and off Bluetooth. Click **Settings > Bluetooth Settings** to configure Bluetooth on your phone. See “Using Bluetooth” for details.
3. Click to toggle between automatically receiving (as items arrive) and manually retrieving Outlook e-mails. For more information, see “To receive e-mails and synchronize other information instantly” in Chapter 3.
4. Click to disconnect active data services (e.g. GPRS). You cannot reconnect data services in Comm Manager.
5. Click to toggle between turning on the phone's ringer and setting the phone to vibration/mute mode.
6. Click to open ActiveSync so you can synchronize the phone and computer. For more information about the configuration settings for ActiveSync, see Chapter 3

Simply click the corresponding button to enable or disable a feature. When you enable a feature, its button gets highlighted. The button appears gray when the corresponding feature is disabled.

## 5.5 Using Bluetooth

Bluetooth is a short-range wireless communications technology. Devices with Bluetooth capabilities can exchange information over a distance of about 8 meters without requiring a physical connection. You can even beam information to a device in a different room, as long as it is within the Bluetooth signal coverage range.

Bluetooth can be used in the following ways:

- Beam information, such as files, appointments, tasks, and contact cards, between devices that have Bluetooth capabilities.
- Synchronize information between your phone and computer via Bluetooth.
- Use a Bluetooth service. Once you connect your phone to another device or computer using Bluetooth, you can locate and use any of the services available on that device.
- Use your phone as a Bluetooth modem for a computer.

### Bluetooth modes

Bluetooth on your phone operates in three different modes:

1. **On.** Bluetooth is turned on. Your phone can detect other Bluetooth-enabled devices, but not vice versa.
2. **Off.** Bluetooth is turned off. In this mode, you can neither send nor receive information using Bluetooth. You might want to turn off the radio at times to conserve battery power, or in situations where radio use is prohibited, such as onboard an aircraft and in hospitals.
3. **Discoverable.** Bluetooth is turned on, and all other Bluetooth-enabled devices within a range of 5 meters can detect your phone.

**Note** By default, Bluetooth is turned off. If you turn it on, and then turn off your phone, Bluetooth also turns off. When you turn on your phone again, Bluetooth automatically turns on.

### To turn on or off Bluetooth on your phone

You can enable Bluetooth by clicking the On/Off switch in Comm Manager. You can also do the following:

1. On the Home screen, click **Start > Settings > Connections > Bluetooth**.
2. In **Bluetooth**, select **On**.
3. Click **Done**.
4. To turn off Bluetooth capabilities on your phone, in **Bluetooth**, select **Off**.

### To make your phone discoverable

1. On the Home screen, click **Start > Settings > Connections > Bluetooth**.
2. In **Bluetooth**, select **Discoverable**.
3. Enter a Bluetooth device name for your phone. This will be the device name that will be shown on another Bluetooth-enabled device when it searches and detects your phone.
4. Click **Done**.

**Note** Selecting the **Discoverable** option on the Bluetooth screen also turns on Bluetooth.

## Bluetooth partnerships

A Bluetooth partnership is a relationship that you create between your phone and another Bluetooth-enabled device in order to exchange information in a secure manner.

Creating a partnership between two devices involves entering the same personal identification number (PIN) on both devices, and this is a one-time process. Once a partnership is created, the devices can recognize the partnership and exchange information without entering a PIN again. Make sure the two devices are within a range of 8 meters, and Bluetooth is turned on and in discoverable mode.



## To create a Bluetooth partnership

1. On the Home screen, click **Start > Settings > Connections > Bluetooth**.
2. Click **Menu > Devices**.
3. Click **Menu > New** to search for a new device.  
Your phone searches for other Bluetooth-enabled devices and lists them.
4. Select the desired device name in the list.
5. Click **Next**.
6. Enter a passkey (1 up to 16 characters) to establish a secure connection, then click **Next**.
7. Wait for the paired device to accept the partnership:
  - If you are creating a Bluetooth partnership between your phone and another Bluetooth-enabled Pocket PC or phone, the receiving party needs to enter the same passkey that you specified.
  - If you are creating a Bluetooth partnership between your phone and computer, a balloon message will appear at the bottom-right of the computer screen, prompting your computer to accept the partnership. Click the message and then enter the passkey.
8. On your phone, a message will appear, indicating that your phone has connected with the paired device. Click **OK**.
9. The name of the paired device is then displayed. You may edit and enter a new name for that device, then click **Next**.
10. Select the check boxes of services that you want to use from the paired device.
11. Click **Done**.

### To accept a Bluetooth partnership

1. Ensure that Bluetooth is turned on and in discoverable mode.
2. Click **Yes** when prompted to establish a partnership with another device.
3. Enter a passkey (the same passkey that is entered on the device requesting the partnership) to establish a secure connection.  
The passkey must be between 1 and 16 characters.
4. Click **Next**.
5. A message will appear, indicating that your phone has connected with the paired device. Click **OK**.
6. The name of the paired device is then displayed. You may edit and enter a new name for that device, then click **Next**.
7. Select the check boxes of services that you want to use from the paired device.
8. Click **Done**. You can now exchange information with another device.

### To change the display name of a Bluetooth device

1. On the Home screen, click **Start > Settings > Connections > Bluetooth**.
2. Click **Menu > Devices**.
3. Select a detected Bluetooth device.
4. Click **Menu > Edit**.
5. Enter a new display name for the Bluetooth device, then click **Next**.
6. Click **Done**.

### To delete a Bluetooth partnership

1. On the Home screen, click **Start > Settings > Connections > Bluetooth**.
2. Click **Menu > Devices**.
3. Select a Bluetooth device.
4. Click **Menu > Delete**.
5. Click **Done**.

## Beam information using Bluetooth

You can beam information, such as contacts, calendar items, and tasks, as well as files from your phone to your computer or to another Bluetooth-enabled device.

**Note** If your computer does not have built-in Bluetooth capabilities, you need to connect and use a Bluetooth adapter or dongle on your computer.

### To beam information from your phone to a computer

1. Set Bluetooth on your phone to discoverable mode. For information about this, see “To make your phone discoverable.”
2. Next, set Bluetooth on your computer to discoverable mode, create a Bluetooth partnership, then enable your computer to receive Bluetooth beams.

If your computer has Windows XP SP2 and your computer’s built-in or external Bluetooth adapter is supported by Windows XP SP2, do the following steps:

- On your computer, open **Bluetooth Devices** from the Control Panel and then click the **Options** tab.
- Select the **Turn discovery on** and the **Allow Bluetooth devices to connect to this computer** options.
- Create a Bluetooth partnership between your phone and computer. For information about creating a partnership, see “Bluetooth partnerships.”
- In the **Options** tab of **Bluetooth Devices**, select **Show the Bluetooth icon in the notification area**.
- To enable your computer to receive Bluetooth beams, right-click the Bluetooth icon at the bottom-right of your computer screen. A menu then opens. Click **Receive a File**.

If the Bluetooth adapter on your computer is installed by a third-party provided driver, do the following steps:

- Open the Bluetooth software that comes with the Bluetooth adapter. This software varies by manufacturer, but in most cases, you will find a **Bluetooth Configuration** utility which you can open from the Control Panel.

- Click the **Accessibility** tab in the Bluetooth Configuration dialog box, then select **Let other Bluetooth devices to discover this computer**.
  - Create a Bluetooth partnership between your device and computer. For information about creating a partnership, see “Bluetooth partnerships.”
  - Refer to the Bluetooth adapter’s documentation for instructions on how to enable your computer to receive Bluetooth beams.
3. Now you’re ready to beam. On your phone, select an item to beam. The item can be an appointment in your calendar, a task, a contact card, or a file.
  4. Click **Menu > Beam [type of item]**.
  5. Select the device name to which you want to beam.
  6. Click **Beam**.
  7. If you beam a calendar, task, or contact item to your computer and it is not automatically added to Outlook, click **File > Import and Export** to import it to Microsoft Outlook on your computer.

To beam information to a Bluetooth-enabled device such as another phone, create a Bluetooth partnership and then do steps 3 to 6 in the above procedure.

### Notes

- If the computer or device you want to beam to cannot be detected by your phone, make sure that it is turned on, discoverable, and within close range (8 meters) of your phone.
- The default folder on your computer where beamed items are stored may be `C:\Documents and Settings\your_username\My Documents`.
- If your computer’s Bluetooth adapter is installed using a third-party provided driver, the folder location where it stores beamed items will be indicated in the **Information Exchange** tab of the **Bluetooth Configuration** utility.

## Use the phone as a Bluetooth modem

You can connect your phone to a notebook or desktop computer through Bluetooth and use the phone as a modem for the computer.

To connect your phone to the computer through Bluetooth, you need a Bluetooth radio adapter (or USB Bluetooth dongle) for your computer.

### To set up a Bluetooth connection between the phone and the computer (in Windows XP SP2)

1. On the phone, turn on Bluetooth and set it to discoverable mode.
2. Connect a Bluetooth radio adapter to your computer. (Refer to the manufacturer's documentation for details on how to install.)  
After a Bluetooth radio adapter is installed on your computer, the Bluetooth Devices icon appears on the Control Panel and System Tray.
3. In the Bluetooth Devices window, click **Add**.
4. The Add Bluetooth Device Wizard opens. Select the **My device is set up and ready to be found** check box, then click **Next**.
5. The wizard then detects your phone as a new device and displays its name in the dialog box. Select the device name, then click **Next**.
6. Select **Let me choose my own passkey**, then enter a passkey (1 up to 16 digits) that serves as an identification number for establishing a secure connection between the phone and the computer. Click **Next**.
7. A confirmation message then appears on your phone. Click **Yes** to accept the connection, enter the same passkey, then click **Next**.
8. On the computer, click **Finish** to exit the wizard.
9. On the phone's Device Added screen, click **OK**.
10. Enter a display name for the computer, then click **Next**.
11. On the Services screen, click **Done**.
12. On the Home screen of your phone, click **Start > Accessories > Wireless Modem**.
13. Select **Bluetooth** as the Connection type.

**14.** To use your phone as a GPRS modem, set the **Access point name (APN)**. To set, click **Menu > APN Setting** and enter the access point name.

**15.** On your notebook, disable ActiveSync.

**Note** To disable ActiveSync on your computer, click **File > Connection Settings** and then clear **Allow connections to one of the following**.

**16.** Click **Menu > Start** on your phone.

After successfully connecting your phone to the computer via Bluetooth, the next thing to do is to add your phone as a Bluetooth modem to your computer.

### To add the phone as a Bluetooth modem

1. On the computer, click **Start > Control Panel > Phone and Modem Options**.
2. Click the **Modems** tab. Check if there is a Bluetooth modem, "Generic Bluetooth Modem" or "Standard Modem over Bluetooth Link," listed. If there is, skip to step 6.
3. If there is no Bluetooth modem listed in the Modems tab, click **Add**.
4. In the Add Hardware Wizard, click **Next**.
5. In the Select Bluetooth Device screen, select the phone name and then click **OK**.
6. In the Modems tab, select the Bluetooth modem listed and then click **Properties**.
7. Click the **Advanced** tab, then in the **Extra initialization commands** text box, enter:  
`AT+CGDCONT=1,"IP","APN"`  
 where APN is the access point name provided by your mobile network operator to give you access to the Internet. Then click **OK**.
8. Click **OK** to exit the Phone and Modem Options.

Your phone is now set up as a Bluetooth modem. For details about how to connect to the Internet, see "Dial-up and connect to the Internet" in this chapter.

# Chapter 6

## Exchanging Messages and Using Outlook

**6.1 Using E-mail and Text Messages**

**6.2 Using MMS Messages**

**6.3 Using Pocket MSN Messenger**

**6.4 Using Calendar**

**6.5 Using Contacts**

**6.6 Using Tasks**

**6.7 Using Voice Notes**

## 6.1 Using E-mail and Text Messages

**Messaging** is where all of your e-mail accounts and your text message account are located. You can send and receive Outlook e-mail, Internet e-mail through an Internet service provider (ISP), and text messages. You can also access e-mail from work using a virtual private network (VPN) connection.

### Set up Outlook E-mail

When starting ActiveSync on your computer for the first time, the Synchronization Setup Wizard prompts you to set up a synchronization relationship. This allows you to synchronize Outlook e-mail and other information between your phone and your computer or the Exchange Server. If you have already set up synchronization through the wizard, then your phone is ready to send and receive Outlook e-mail. For information about the Synchronization Setup Wizard, see “To install and set up ActiveSync on the computer” in Chapter 3.

If you have not set up a synchronization relationship yet, do the following to set up your device to synchronize Outlook e-mail:

1. To set up and connect to an over-the-air connection (GPRS or ISP dial-up) to synchronize remotely, follow the procedures in “Connecting to the Internet” in Chapter 5.
2. Disconnect your phone from your computer or LAN. (If you have an over-the-air connection, there is no need to disconnect).
3. Click **Start > ActiveSync**.
4. If you want to synchronize e-mails directly with the Exchange Server on a private network such as your corporate network, follow the steps in “Synchronize Outlook information with Exchange Server” in Chapter 3.
5. Choose the information types to synchronize. Make sure **E-mail** is selected. For details, follow the steps in “To change which information is synchronized” in Chapter 3.



Everytime you want to manually send or receive Outlook e-mail on your phone, just connect your phone to your computer, LAN, or over-the-air connection, then click **Sync** on the ActiveSync screen or click **Menu > Send/Receive** in Outlook on your phone.

For details about scheduling automatic synchronization or setting a synchronization time with the Exchange Server, see “Schedule synchronization with Exchange Server” in Chapter 3.

## Set up a POP3/IMAP4 e-mail account

You need to set up an e-mail account that you have with an Internet service provider (ISP) or an account that you access using a VPN server connection (typically a work account) before you can send and receive e-mail.

1. On the Home screen, click **Start > Messaging** and click any item on the Messaging screen.
2. Click **Menu > Options > New Account**.
3. In **Your name**, enter your display name for e-mail messages.
4. In **E-mail address**, enter the e-mail address for this account.
5. Select **Attempt to obtain e-mail settings from the Internet** and click **Next**.

**Auto Setup** attempts to download necessary e-mail server settings so that you do not need to enter them manually. If the account is set up successfully, you will be prompted to send and receive e-mail.

If **Auto Setup** is unsuccessful or you have an account you access using a VPN server connection, contact your ISP or network administrator for the following information and enter it manually:

Setting	Description
<b>User name</b>	Enter the user name assigned to you by your ISP or network administrator. This is often the first part of your e-mail address, which appears before the at sign (@).
<b>Password</b>	Choose a strong password. You have the option to save your password so you do not need to enter it each time you connect to your e-mail server.
<b>Domain</b>	Not required for an account with an ISP. May be required for a work account.
<b>Server type</b>	Select POP3 or IMAP4.
<b>Account name</b>	Enter a unique name for the account, such as "Work" or "Home." This name cannot be changed later.
<b>Network</b>	Enter the type of network your e-mail server connects to.
<b>Incoming server</b>	Enter the name of your e-mail server (POP3 or IMAP4).
<b>Require SSL connection</b>	Select this to ensure you always receive e-mail for this account using an SSL connection. This enables you to receive personal information more securely. Please note that if you select this and your ISP does not support an SSL connection, you will not be able to connect to receive e-mail.
<b>Outgoing server</b>	Enter the name of your outgoing e-mail server (SMTP).
<b>Outgoing server requires authentication</b>	Select this if your outgoing e-mail server (SMTP) requires authentication. Your user name and password from above will be used.
<b>Outgoing server settings</b>	Your outgoing e-mail server may require different authentication settings than your incoming e-mail server.
<b>Use different user name for outgoing server</b>	Select this if your outgoing e-mail server requires a different user name and password than the ones you entered before.
User name:	Enter your user name for the outgoing e-mail server.
Password:	Enter your password for the outgoing e-mail server.
Domain:	Enter the domain of the outgoing e-mail server.
Require SSL connection: (Outgoing mail server only)	Select this to ensure you always send e-mail from this account using an SSL connection. This enables you to send personal information more securely. Please note that if you select this and your ISP does not support an SSL connection, you will not be able to send e-mail.

## Send and receive messages

### To compose and send an e-mail or text message

1. On the Home screen, click **Start > Messaging**.
2. Select an e-mail account, or select **Text Messages**. Then, click **Select**.
3. Click **New**.
4. Enter the e-mail address or phone number of one or more recipients, separating them with a semicolon (;). To access addresses and phone numbers from Contacts, in **To**, press **ENTER** and select a recipient from the list.
5. Enter a message.
6. Click **Send**.

**Note** If you are working offline, e-mail messages are moved to the Outbox folder and will be sent the next time you connect. Text messages are sent immediately.

### Tips

- To set the priority of an e-mail message, click **Menu > Message Options**.
- To cancel any message, click **Menu > Cancel Message**.
- If you are sending a text message and want to know if it is received, before sending the message, click **Menu > Message Options**. Select **Request message delivery notification**.

### To reply to or forward a message

1. From an open message, click **Reply**, or click **Menu > Reply All** or **Forward**.
2. Enter a message in the message area.
3. Click **Send**.

**Note** If you are replying to or forwarding e-mail from Outlook E-mail, you will send less data if you do not edit the original message. This may reduce data transfer costs based on your rate plan.

### To exclude your e-mail address when replying to all

When you reply to all the recipients of an e-mail, your own e-mail address will also be added to the recipient list. You can customize ActiveSync so that your e-mail address will be excluded from the recipient list.

1. On the Home screen, click **Start > ActiveSync**.
2. Click **Menu > Options**.
3. Select **Email**, and click **Settings**.
4. Click **Menu > Advanced**.
5. In the **Primary e-mail address** text box, enter your e-mail address.



6. Click **Done**.

### To add an attachment to an e-mail message

1. In a new message, click **Menu > Insert** and then click **Picture or Voice Note**.
2. Select the picture you want to attach, or record a voice note.

### To download attachments

- In an open message with an attachment, select the attachment. The attachment is downloaded the next time you synchronize or connect to your e-mail server when sending and receiving e-mail.

## Download messages

The manner in which you download messages depends on the type of account you have:

- To send and receive e-mail for an Outlook E-mail account, begin synchronization using ActiveSync. For more information, see “Set up Outlook e-mail” in this chapter.
- To send and receive e-mail messages for an e-mail account that you have with an Internet Service Provider (ISP) or that you access using a VPN server connection (typically a work account), download messages through a remote e-mail server. For more information, see “To download messages from the server” below.
- Text messages are automatically received when your phone is turned on. When your phone is in flight mode, messages are held by your service provider until you turn off flight mode.

### To download messages from the server

To send and receive e-mail messages for an e-mail account that you have with an Internet Service Provider (ISP) or that you access using a VPN server connection (typically a work account), you first need to connect to the Internet or your corporate network, depending on the account.

1. On the Home screen, click **Start > Messaging**.
2. Select the e-mail account.
3. Click **Menu > Send/Receive**. The messages on your phone and e-mail server are synchronized as follows: new messages are downloaded to the phone Inbox folder, messages in the phone Outbox folder are sent, and messages that have been deleted from the server are removed from the phone Inbox folder.

**Tip** If you want to download the entire message, select the message and click **Menu > Download Message**. The remainder of the message will be downloaded the next time you send and receive e-mail.

## Individually sign and encrypt a message

Encrypting an Outlook e-mail message protects the privacy of the message by converting it from plain, readable text into cipher (scrambled) text. Only the recipient who has the authorization key can decipher the message.

Digitally signing a message applies your certificate with the authorization key to the message. This proves to the recipient that the message is from you and not from an imposter or a hacker, and that the message has not been altered.

### To digitally sign and encrypt a new message

1. In the message list, select **Outlook E-mail**.
2. Click **New**.
3. Click **Menu > Message Options**.
4. In the **Security** field, select the **Encrypt message** and **Sign message** check boxes. Then click **Done**.

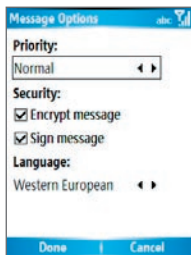

## Verify the digital signature on a signed message you receive

To verify a digital signature in the message that you receive, do the following:

1. Open the Outlook e-mail message that has been digitally signed.
2. At the top of the message, click **View Signature Status**.

### 3. Click **Menu > Check Certificate**.

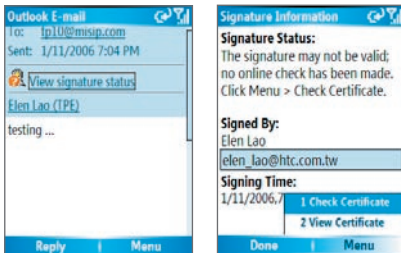

### 4. To view the details of the certificate in the message, click **Menu > View Certificate**.

**Note** There can be several reasons why a digital signature is not valid. For example, the sender's certificate may have expired, it may have been revoked by the certificate authority, or the server that verifies the certificate is unavailable. Contact the sender to report the problem.

## Manage folders

Each Messaging account has its own folder hierarchy with five default Messaging folders: Inbox, Outbox, Deleted Items, Drafts, and Sent Items. The messages you receive and send through the account are stored in these folders. You can also create additional folders within each hierarchy. Folders for e-mail accounts behave differently depending on the type of e-mail account you have.

If you set up an Outlook E-mail account to sync with Exchange Server or a desktop PC, e-mail messages in the Inbox folder in Outlook will be synchronized automatically with your phone. You can select to synchronize additional folders by designating them for synchronization. The folders you create and the messages you move will then be mirrored on the e-mail server. For example, if you move two messages from the Inbox folder to a folder named Family, and you have designated Family for synchronization, the server creates a copy of the Family folder and copies the messages to that folder. You can then

read the messages while you are away from your PC. You can only create and delete folders on devices when you are connected to an Exchange e-mail server.

Similar to the Outlook account, if you set up an account to send and receive mail using an IMAP4 e-mail server, all messages on the phone are copies of the messages on the server. The folders you create locally on the phone and the e-mail messages you move to these folders are mirrored on the e-mail server. Moving a message on the phone moves the copy on the server the next time you send and receive e-mail for that account. Therefore, messages are available to you anytime you connect to your e-mail server, whether it is from your phone or PC. This synchronization of folders occurs whenever you connect to your e-mail server, create new folders, or rename/delete folders when connected. You can also set different download options for each folder.

If you set up an account to send/receive mail using a POP3 e-mail server, e-mail messages you move to the Deleted Items folder on the phone will break the link between the messages on the phone and their copies on the e-mail server. The next time you connect to send and receive mail, the e-mail server will detect the messages that are in the Deleted Items folder on the phone and will delete those messages from the e-mail server. All other messages in other folders remain on both the phone and the e-mail server.





## 6.2 Using MMS Messages

Creating and sending Multimedia Message Service (**MMS**) messages to your friends and family is fun and easy. You can include or capture photos or video clips, include or record audio, add text, then send them along with your MMS message.

### To access MMS

Do any of the following:

- On the Home screen, click **Start > Messaging > MMS**.
- From the Pictures & Videos program, select a picture in My Pictures, and click **Menu > Send**. Select **MMS** as the messaging account to send the picture along with the message.
- From the Camera program, capture a photo and then click the Send icon (  ), select **Send via MMS** and click **Send**; or record an MMS video clip and then click the Send icon (  ).

### To access MMS message folders

- Click **Start > Messaging > MMS**, then click **Menu > Folders**.

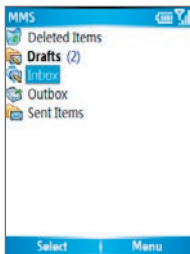

MMS Message Folders

### Edit MMS settings

When you send an MMS message, an SMS notification message will first be sent to the recipient, while your MMS message will be temporarily stored on an MMS server of your wireless service provider. When others send you an MMS message, similarly, the MMS message will be stored on the MMS server, awaiting for you to retrieve it. Hence,

your phone must be configured with the location of the MMS server for you to be able to send and receive MMS messages on your phone.

When you purchase your phone, it is already preset with your wireless service provider's MMS server settings. If you accidentally lost the preset settings or you changed to another wireless service provider, follow the steps below to configure MMS settings.

### To configure MMS settings

1. On the MMS main screen, click **Menu > Options > Account Options > MMS** to open the Preferences screen.
2. Select or clear the provided check boxes according to your needs. You can choose to keep track of your MMS messages, retrieve messages immediately, accept or reject messages, and request a delivery or read receipt. You can also specify a resolution for images you send and message delivery attempts.
3. On the Preferences screen, click **Menu > MMSC Settings > Edit** to access Multimedia Messaging Service Center (MMSC) settings.
4. Check if your phone is preset with MMS server settings.

If there are no preset settings, click **Menu > New** on the MMSC Settings screen and enter the following information, which you can get from your wireless service provider:

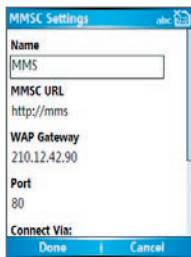

- **Name.** A descriptive name, such as your wireless service provider name.
  - **MMSC URL.** URL address of the MMS server.
  - **WAP Gateway.** Location of the MMS server, which is usually in the form of an IP address.
  - **Port.** HTTP port number used for connecting to the MMS server and for file transfer.
  - **Connect Via.** Select **The Internet** from the list.
  - **Max. Sending Size.** Select the maximum MMS message size allowed by your wireless service provider.
  - **WAP Version.** Select either **WAP 1.2** or **WAP 2.0**, depending on which one is being used by your wireless service provider.
5. Click **Done**.

The MMS server settings will then be added as an entry on the MMS Configuration screen.

**Note** If you add several MMS service providers to the MMSC Settings screen, you can choose one as your default MMS provider. Select the MMS provider's name in the list, then click **Menu > Set as Default**.

## Create and send MMS messages

You can compose MMS messages in a combination of various slides, where each slide can consist of a photo, audio or video clip, and/or text.

### Notes

- Please note that MMS is a charged service. In order to use MMS successfully, this has to be provisioned on your mobile account. Please contact the wireless service provider to have this provisioned as part of your calling plan.
- Please ensure the size of the MMS is within the limits of the wireless service provider if sending to another mobile phone user or sending to an e-mail address.

### To start composing an MMS message

1. On the Home screen, click **Start > Messaging > MMS > New**.
2. In **To**, enter the recipient's phone number or e-mail address directly, or press ENTER to choose a phone number or an e-mail address from Contacts. You can also click **Menu > Recipients > Add** to add a new contact entry.
3. In **Subject**, enter a subject for your message.
4. Click **Insert Picture/Video** to select a photo or video clip from the Select Media screen and insert it.
5. Enter text and insert audio clips by clicking the respective fields.
6. Click **Send** to send the message.

**Note** To send a copy of this message to others, access **Cc** and **Bcc** by clicking **Menu > Send Options**. In these fields, enter the recipient's phone number or e-mail address or click **Menu > Recipients > Add** to add from Contacts.

The following symbols act as shortcuts to some of the options on the MMS Message screen.

- Press NAVIGATION left (◀) to go to the previous slide.
- Press NAVIGATION right (▶) to go to the next slide.

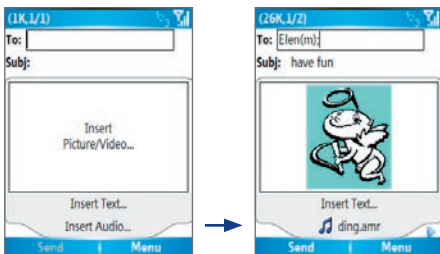

Composing an MMS Message

### To create an MMS message from a template

- On the blank MMS message screen, click **Menu > Template > New from Template** to compose a message using a predefined template.

**Note** To save a message as a template, create a message or open an existing message, and click **Menu > Template > Save as Template**.

### To insert a photo or video clip into an MMS message

You can add either a still image or a video clip to each individual slide on the MMS message screen.

- Click **Insert Picture/Video** to insert a photo or video clip.
- Select a picture or video clip on the Select Media screen. This is the My Pictures folder where images and video clips are displayed in thumbnail view. To navigate to any other folder containing pictures or videos, click **Menu > Change Folder**.
- Select a photo or video clip by using NAVIGATION, and click **Select** or **Menu > Select** to insert it.

On the Select Media screen, you can view the thumbnails in list view, open an item to view it, or delete an item by clicking **Menu** and choosing the appropriate option. You can even discard this photo or video clip by pressing BACK. To capture a new photo or video clip and send it immediately with the message, click **Menu > Capture Picture** or **Menu > Capture Video**. The newly captured photo or video clip is automatically inserted into your message.

### To add predefined text to an MMS message

You can instantly add text to any slide from a list of predefined words or phrases, called Canned Text.

- On the MMS message screen, click **Menu > Insert Object > Canned Text** and then click **Select** or **Menu > Select** to add a text string from the Canned Text list.

**Note** To edit or delete a phrase on the Canned Text list, select a text string and click **Menu > Edit** or **Menu > Delete**. To create and add a new phrase to the list, click **Menu > New**.

### To add an audio clip to an MMS message

You can add audio clips to your MMS messages. However, you can add only one audio clip per slide.

1. Click **Insert Audio** to insert an audio clip.  
Select an audio clip on the Select Audio screen.

**Note** By default, the audio clips listed on the Select Audio screen are from the My Sounds folder. To navigate to any other folder containing audio clips, click **Menu > Change Folder**.

2. Select an audio clip using NAVIGATION, and click **Select** or **Menu > Select** to insert it.

**Note** You can play and listen to the audio clip by clicking **Menu > Play** before you insert it.

Otherwise, to record a new audio clip, click **Menu > Capture Audio**. Then click **Record** to start recording and **Stop** to stop recording. Click **Play** to listen to the new audio clip you captured, then click **Done**.

The new audio clip is then added to your MMS message.

### To set options for an MMS message

While composing an MMS message, you can set the following options for the message by clicking **Menu**.

Option	Allows you to
<b>Recipients</b>	Specify the phone number or e-mail address of the recipient(s).
<b>Insert Object</b>	Choose to insert a picture/video, audio, or predefined text.
<b>Capture</b>	Capture a photo, audio or video clip to be inserted into the message.
<b>Attachments</b>	Choose to attach a vCard, vCalendar, or other file.
<b>Remove Picture/ Remove Video</b>	Delete a photo/video from the message.
<b>Remove Audio</b>	Delete an audio clip from the message.
<b>Remove Text</b>	Delete text from the message.
<b>Slides</b>	Add and remove slides, view the next or previous slides, and specify the duration of slides.

Option	Allows you to
<b>Cancel Message</b>	Cancel the message and go back to the MMS Messaging folders screen.
<b>Background</b>	Choose a background color from the list.
<b>Template</b>	Compose a message using a predefined template, and save a composed or existing message as a template.
<b>Send Options</b>	Specify the message delivery time, validity, priority, class, and other settings for a message.
<b>Preview Message</b>	Playback the contents of the MMS message before sending it.
<b>Send Message</b>	Send the message to the recipients.

## View and reply to MMS messages

### To receive MMS messages

- On any MMS message folder screen, click **Menu > Send/Receive**.  
By default, messages are automatically downloaded to your phone.

### To view an MMS message

You can view MMS messages in several ways.

- Press ENTER to view and play the message on your phone. Click **Pause** or **Menu > Stop** to pause the playback of the message.
- Click **Menu > Object View** to see a list of files included in the message. To open a file, select it and click **Open**. To save a file, select it, and click **Save**, **Menu > Save Audio**, or **Menu > Save Photo**.
- View each slide included in the message by clicking **Menu > Next**.

### To reply to an MMS message

- Click **Menu > Reply > Reply** to reply to the sender of the message, or click **Menu > Reply > Reply All** to reply to all persons listed in the To and CC boxes of the message. Click **Menu > Reply > Forward** to forward the message to someone else.

## 6.3 Using Pocket MSN Messenger

Pocket MSN Messenger delivers the features of MSN Messenger to your phone. With Pocket MSN Messenger, you can do the following:

- Send and receive instant messages.
- See which contacts are online or offline.
- Subscribe to status updates for selected contacts so you know when they come online.
- Block contacts from seeing your status or sending you messages.

Before you can use MSN Messenger, your phone must be connected to the Internet. For information about setting up an Internet connection, see “Connecting to the Internet” in Chapter 5.

**Important Note** You must have either a Microsoft .NET Passport or a Hotmail account to use MSN Messenger. If you have a Hotmail.com or MSN.com e-mail address, you already have a Passport. To get a Passport account, go to <http://www.passport.com>. To get a Hotmail account, go to <http://www.hotmail.com>.

### To start MSN Messenger

1. On the Home screen, click **Start > Pocket MSN**.
2. Click **MSN Messenger**.

### To sign in or out

- On the main MSN Messenger screen, click **Sign In**. Enter the e-mail address and password for your Passport or Hotmail account, and click **Sign In**.  
Signing in may take several minutes, depending on the connection speed.
- To sign out, click **Menu > Sign Out**.

### To add or delete contacts

- To add a contact, click **Menu > Add Contact**, and follow the instructions on the screen.
- To delete a contact, select the contact and click **Menu > Delete Contact**.



**To send an instant message**

1. Click the contact to whom you will send a message.
2. Enter your message in the text entry area at the bottom of the screen, and click **Send**.

**Note** To quickly add common phrases, click **Menu > My Text** and select a phrase in the list.

**To block or unblock contacts**

- To block a contact from seeing your status and sending you messages, select the contact and click **Menu > Block**.
- To unblock a contact, select the contact, and click **Menu > Unblock**.

**To change your own Messenger status**

1. Click your own name at the top of the screen.  
Your current status is indicated by a bullet point in the displayed list.
2. Select a status (such as Out To Lunch) from the list.

**To change your display name**

1. Click **Menu > Options**.
2. In **My display name**, enter the name you want to display to others in MSN Messenger.
3. Click **Done**.

## 6.4 Using Calendar

Use Calendar to schedule appointments, including meetings and other events. Your appointments for the day can be displayed on the Home screen. If you use Outlook on your PC, you can synchronize appointments between your phone and PC. You can also set Calendar to remind you of appointments with a sound, for example.

### To schedule an appointment

1. On the Home screen, click **Start > Calendar**.
2. Click **Menu > New Appointment**.
3. Enter information about the appointment.
4. To schedule an all-day event, in **End time**, select **All day event**.
5. Click **Done**.

**Note** All-day events do not occupy blocks of time in Calendar; instead, they appear in banners at the top of the calendar.

### To make an appointment recurring

1. On the Home screen, click **Start > Calendar**.
2. Click the appointment and click **Edit**.
3. Scroll to **Occurs** and click one of the recurrence options.
4. Click **Done**.

### To view your schedule

You can view your schedule in three different views: Month, Week, and Agenda.

1. On the Home screen, click **Start > Calendar**.
2. Do one of the following:
  - Click **Menu > Month View**.
  - Click **Menu > Week View**.
  - Click **Menu > Go to Today**, or from **Week** or **Month** view, click **Menu > Agenda View**.

### To send a calendar appointment

You can send a calendar appointment to another phone over MMS.

1. On the Home screen, click **Start > Calendar**.
2. Select an appointment, then click **Menu > Send as vCalendar**.
3. Enter the recipient in the **To** line of the MMS message, then click **Send**.

## 6.5 Using Contacts

Contacts is your address book and information storage for the people and businesses you communicate with. Store phone numbers, e-mail addresses, home addresses, and any other information that relates to a contact, such as a birthday or an anniversary date. You can also add a picture or assign a ring tone to a contact.

From the contact list, you can quickly communicate with people. Click a contact in the list for a summary of contact information. From there, you can call or send a message.

If you use Outlook on your PC, you can synchronize contacts between your phone and PC.

### To create a new contact

1. On the Home screen, click **Start > Contacts > New**.
2. Enter information for the new contact.
3. Click **Done**.

### Tips

- If someone who isn't in your list of contacts calls you or sends you a message, you can quickly create a contact from Call History or from the message by clicking **Menu > Save to Contacts**.
- In the list of contact information, you'll see where you can add a picture or assign a ring tone to a contact.

### To create a new contact on both your phone and SIM card

1. On the Home screen, click **Start > Contacts > Menu > New SIM Contact**.
2. Enter information for the new contact and then click **Done**.

**Tip** To manage your SIM card contacts, use SIM Manager. To access SIM Manager, click **Start > Accessories > SIM Manager**. SIM Manager lets you copy contacts from **Contacts** to the SIM card, add SIM card contents to **Contacts**, show SIM card storage information and more.

### To view and edit a contact information

1. On the Home screen, click **Start > Contacts**.
2. Click the contact whose information you want to view.
3. To edit the information, click **Menu > Edit**.
4. When finished making changes, click **Done**.

### To call a contact from the contact list

1. On the Home screen, click **Start > Contacts**.
2. Click the contact to call.
3. Press TALK (). The contact's default phone number is dialed.

**Tip** To call a phone number other than the default, click the contact, scroll to the number you want to dial, and press TALK (.

### To send an e-mail to a contact

1. On the Home screen, click **Start > Contacts**.
2. Click the contact.
3. Click the e-mail address.
4. Select the e-mail account to use.
5. Enter a subject, compose your message, and click **Send**.

### To send a text message to a contact

1. On the Home screen, click **Start > Contacts**.
2. Click the contact, and click **Menu > Send Text Message**.
3. Compose your message, and click **Send**.

### To find a contact

1. On the Home screen, click **Start > Contacts**.
2. If you are not in Name view, click **Menu > View By > Name**.
3. Do one of the following:
  - Begin entering a name or phone number of the contact until the contact is displayed. When you press a number, such as 5, you find names that begin with J, K, and L, as well as phone numbers that start with 5. The next number you press continues to narrow the search. For example, to find "John," you would press 5, 6, 4, and then 6.

- Filter the list by categories. In the contact list, click **Menu > Filter**. Then click a category you've assigned to a contact. To show all contacts again, select **All Contacts**.
- Locate the contact by company. In the contact list, click **Menu > View By**, and click **Company**. Click the company to see the contacts who work there.

### To find a contact online

In addition to having contacts on your phone, you can also access contact information from your organization's Global Address List (GAL). GAL is the address book that contains all user, group, and distribution list e-mail addresses of your organization, and it is stored on the Exchange Server. By having direct online access to it from your phone, it is quick and easy for you to plan a meeting and e-mail a meeting request immediately to anyone in your organization.

Access to the GAL is available if your organization is running Microsoft Exchange Server 2003 SP2 and you have completed your first synchronization with the Exchange Server.

1. Synchronize with Exchange Server if you have never done so.
2. Click **Start > Contacts > Menu > View By > Name**.
3. Do either of the following:
  - In Contacts, click **Menu > Find Online**.

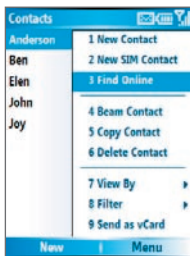

- In a new message, in the **To** box, click **Menu > Add Recipient> Menu > Find Online**.

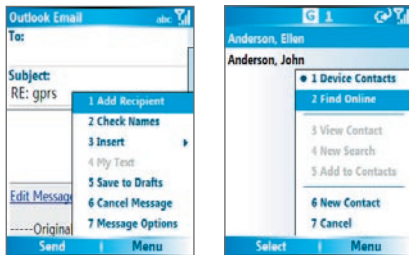

4. Enter the contact name and click **Find**. Select one contact in the result list and click **Select**.

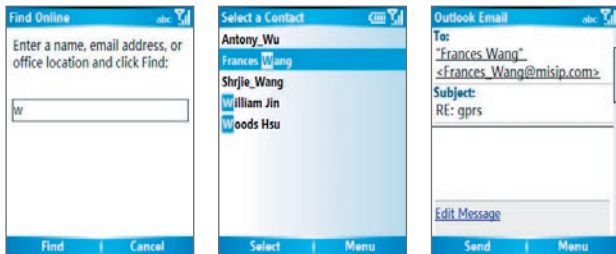

### Notes

- Your phone must be set up with a data connection.
- You can search on the following information as long as that information is included in your organization's GAL: First name, Last name, E-mail name, Display name, E-mail address, or Office location.

### To filter the contact list

Contacts that have categories assigned are displayed in the list when you filter by category.

1. On the Home screen, click **Start > Contacts**.
2. Click **Menu > Filter**.
3. Click a category to filter.

### To assign a ring tone to a contact

To easily identify who is calling you, you can assign a custom ring tone to each contact.

1. On the Home screen, click **Start > Contacts**.
2. Click the contact you want to assign a ring tone to.
3. Click **Menu > Edit**.
4. Click **Custom ring tone** and select the ring tone you want.
5. Click **Done**.

### To assign a picture to a contact

1. On the Home screen, click **Start > Contacts**.
2. Click the contact.
3. Click **Menu > Edit**.
4. Click **Picture**.
5. Click the picture you want to add.

### To send a contact's details

You can send a contact card to another phone over MMS.

1. On the Home screen, click **Start > Contacts**.
2. Select a contact, then click **Menu > Send as vCard**.
3. Enter the recipient in the **To** line of the MMS message, then click **Send**.

## 6.6 Using Tasks

Use Tasks to keep track of things you need to do. A task can occur once or repeatedly (recurring). You can set reminders for your tasks and you can organize them using categories. Your tasks are displayed in a task list. Overdue tasks are displayed in red.

### To create a task

1. On the Home screen, click **Start > Tasks**.
2. In the **Enter new task here** box, enter the task name and press ENTER.

### Notes

- You can synchronize information on your phone with your PC to keep your task list up to date in both locations.
- If you create a new task with a reminder on your PC and then synchronize tasks with your phone, the reminder will play at the time that was set on your PC.

### To delete a task

1. On the Home screen, click **Start > Tasks**.
2. Select the task, and click **Menu > Delete Task**.

### To locate a task

1. On the Home screen, click **Start > Tasks**.
2. In the task list, do one of the following:
  - To sort the list, click **Menu > Sort by**, and click a sort option.
  - To filter the list by category, click **Menu > Filter**, and click the category you want to be displayed.

**Note** Categories appear only in tasks that are synchronized with your PC.

**Tip** To filter your tasks further, click **Active Tasks** or **Completed Tasks**.

### To mark a task as completed

1. On the Home screen, click **Start > Tasks**.
2. Select the task, and click **Complete**.



## 6.7 Using Voice Notes

Use Voice Notes to create short voice recordings. Voice notes are included in the All Notes list and are named consecutively (Recording1, Recording2, and so on).

### To create a voice note

1. On the Home screen, click **Start > Voice Notes**.
2. Hold the phone's microphone near your mouth.
3. Click **Record** and say your voice note.
4. Click **Stop** to stop recording a voice note.

### To delete a voice note

1. On the Home screen, click **Start > Voice Notes**.
2. Select the voice note to delete.
3. Click **Menu > Delete**.
4. Click **Yes**.

**Tip** If you delete a voice note that has a default name, such as Recording1, this name becomes available for a new voice note.

### To listen to a voice note

1. On the Home screen, click **Start > Voice Notes**.
2. Select the voice note to play, and press ENTER.

**Tip** To stop listening to the voice note, click **Stop** while the voice note is playing.

### To use a voice note as a ring tone

1. On the Home screen, click **Start > Voice Notes**.
2. Select the voice note, and click **Menu > Set As Ringtone**.



# Chapter 7

## Experiencing Multimedia

**7.1 Using Camera and Video Recorder**

**7.2 Using Pictures & Videos**

**7.3 Using Windows Media Player**

**7.4 Using MIDlet Manager**



## 7.1 Using Camera and Video Recorder

Taking photos and shooting video clips with audio are easy with your phone's built-in camera.

### To open Camera or Video Recorder

Do any of the following:

- On the Home screen, click **Start > Camera**.
- On the Home screen, click **Start > Video Recorder**.
- Press the CAMERA button on your phone.

### To exit Camera or Video Recorder

- Press END (📞).

### To capture photos and video clips

You can do one of the following to capture photos and video clips:

- Click **Capture** on the Camera screen to take a photo. Also, click **Capture** to start recording a video clip and then click **Stop** to end the recording.
- Press the CAMERA button once to take a still image or to start recording a video clip. When capturing video, you can also stop video recording by pressing this button.
- Alternatively, you can press the ENTER button on the NAVIGATION control to take a picture when you are capturing a still image. Press this button to start recording a video clip; press it again to stop recording.







## Capture modes

The Camera program lets you capture pictures and video clips by using various built-in modes. By default, Camera opens in the capture mode you last accessed. The title bar displays the active capture mode.

### To change the capture mode

- On the Camera screen, click **Menu > Capture Mode** and select a capture mode from the list.

The available capture modes are as follows:

Capture mode	Function
Photo (  )	Captures standard still images.
Video (  )	Captures video clips, with or without audio.
MMS Video (  )	Captures video clips suitable for sending via MMS.
Contacts Picture (  )	Captures a still image suitable for assigning as an identification photo to a contact.
Picture Theme (  )	Captures still images and places them within frames.
Sports (  )	Captures a sequence of still images (3 or 5 frames) automatically for a short duration at a defined frequency.



Using the above capture modes, the camera captures files in the following formats:

Capture type	Format
Still Image	JPEG
Video	Motion-JPEG AVI (.avi) MPEG-4 (.mp4) H.263 baseline (.3gp)
MMS Video	MPEG-4 (.mp4) H.263 baseline (.3gp)

## Camera mode icons and indicators

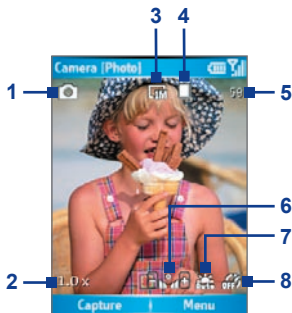
### The Camera [Photo] screen



- 1 Capture mode.** Indicates the current capture mode.
- 2 Zoom-ratio.** Indicates the current zoom ratio. Press NAVIGATION up or down to increase or decrease the zoom level.
- 3 Resolution.** Indicates the image or video size for the current capture mode. For the list of available resolutions, see the table in “Use Zooming.”
- 4 Storage location.** Indicates where the captured images and video clips will be saved. The  icon indicates the phone's main memory; the  icon indicates the storage card.
- 5 Remaining number Indicator.** In Photo, Contacts Picture, Picture Theme, and Sports, this shows the remaining, available shots of pictures that you can take based on current settings. In Video and MMS Video modes, this shows the remaining duration that can be recorded. While recording video, this shows the recorded duration.
- 6 Exposure Value (EV).** Allows you to adjust the exposure value from -2 EV to +2 EV (increments of 0.5) by pressing NAVIGATION left or right.

- 7 **White Balance.** Indicates the current white balance setting.

☀️ : Auto; 🌞 : Daylight; 🌙 : Night; 💡 : Incandescent;  
 📺 : Fluorescent.

- 8 **Self-timer.** Indicates the current Self-timer setting while capturing images. Click **Menu > Self-timer** to select the Self-timer setting (**Off, 2 seconds, or 10 seconds**).

### The Camera [Video] screen



Recording Status

The Recording Status indicator shows a red, blinking indicator while video recording is in progress.

### The Camera [Picture Theme] screen

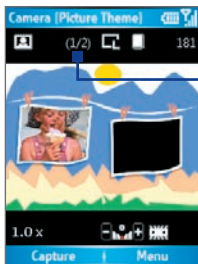

Template Status

The Template Status displays the current and total number of photos that can be taken using the selected template.

## The Review screen

After capturing an image or recording a video clip, the Review screen appears allowing you to decide the action for the image/video file.



Icons for Photo, Video, MMS Video, and Picture Theme modes.



Icons for Contacts Picture mode.



Icons for Sports mode.

Icon	Function
	<b>Back.</b> Click to go back to Camera screen.
	<b>Delete.</b> Click to remove the captured image or video clip.
	<b>Send.</b> Click to send the captured image or video clip to someone via e-mail or MMS.
	<b>View.</b> Click to switch to Pictures & Videos program to show the still image, or switch to Windows Media Player to play back the video clip.
	<b>Assign to Contacts.</b> Click to associate the photo to a selected contact.
	<b>Browse.</b> After you have taken photos in Sports mode, the total number of consecutive shots is shown in the lower right corner of the Review screen. Press NAVIGATION up or down to browse through the sequence of photos.



### Note

If you capture a photo for the contact by using the Contacts Picture mode, the picture size is 128 x 128 dots, which will be displayed as a full-screen image on the external screen. You can also assign or change the photo for the contact by using the Pictures & Videos program (see page 127) or through the **Menu > Edit** of Contacts (see page 109).



## Use Still Image capture modes

While using Still Image capture modes such as Photo, Contacts Picture, Picture Theme, and Sports, you can capture a single still image by clicking **Capture**. You can also press the CAMERA button or the ENTER button on the NAVIGATION control to capture the image. Still images are captured and saved in the JPEG format.

While capturing an image in the Picture Theme mode, you can select a preset template. To browse and choose from different templates, click **Menu > Template** on the Camera screen to select a template. Depending on the chosen template, one or more photos may need to be taken for the template.

## Use Video capture mode

While using the Video capture mode, you can click **Capture**, press the ENTER button, or press the CAMERA button on your phone to start recording a video clip (with audio if desired). To stop recording, click **Stop** or press either the ENTER button or the CAMERA button again. Your phone displays the first frame of the captured video clip by default on the Review screen.

Before you capture a video clip, click **Menu > Advanced > Capture Format** on the Camera screen to specify the file format. You can set the encoding format to Motion-JPEG AVI, MPEG-4, or H.263. You can also specify the recording limit in terms of time or file size by clicking **Menu > Advanced > Recording Limit**. To change the video resolution, click **Menu > Capture Settings > Resolution**.

## Use MMS Video capture mode

While using the MMS Video capture mode, click **Capture** on the Camera screen to start capturing a video clip. You can also press the ENTER button or the CAMERA button on your phone to start recording a video clip (with audio if desired). To stop recording, click **Stop** or press either the ENTER button or the CAMERA button again.

The recording length of MMS video is fixed. The recording automatically stops when the preset length is reached. However, you can manually stop recording the video anytime. The time indicator at the top-right side of the screen indicates the time limit.

You can specify the encoding format to be either H.263 or MPEG-4 by clicking **Menu > Advanced > Capture Format**; however, the ideal format for MMS is H.263 (3GP).

After you capture the video file, click the Send icon (  ) to send the file through MMS.



## Use zooming

Before capturing a still image or a video clip, you can first zoom in to make the object in focus move closer, and you can zoom out to make the object move farther away. In all capture modes, press NAVIGATION up on your phone to zoom in, NAVIGATION down to zoom out. Alternatively, click **Menu > Zoom** to select a zoom ratio.

The camera zoom range for a picture or a video clip depends on the capture mode and capture size. The following table is a summary.

Please note the capture sizes available for certain capture formats also vary from one capture mode to another. The zoom range has been calculated based on the following ratio:

- 1.0x = normal size (no zooming)
- 2.0x = double enlargement
- 4.0x = four times enlargement
- 8.0x = eight times enlargement

Capture mode	Resolution	Zoom range
Video and MMS Video	Small (128 x 96) Medium (176 x 144), default	1.0x, 2.0x
Photo	Small (160 x 120)	1.0x to 8.0x
	Medium (320 x 24)	1.0x to 4.0x
	Large (640 x 480) 1M (1280 x 1024), default	1.0x to 2.0x 1.0x to 2.0x
Contacts Picture	Small (128 x 128)	1.0x to 4.0x
Picture Theme	Determined by the current template	Depends on the size of the currently loaded template
Sports	Small (160 x 120)	1.0x, 2.0x, 4.0x, 8.0x
	Medium (320 x 24)	1.0x, 2.0x, 4.0x
	Large (640 x 480), default	1.0x, 2.0x

## Use the Camera Menu

Clicking **Menu** on the Camera screen allows you to select various capture modes and customize various settings for each mode. The following table provides a list of the general options in the Menu.

Option	Allows you to
<b>Self-timer</b>	Select the Self-timer option for capturing images: <b>Off</b> , <b>2 seconds</b> , or <b>10 seconds</b> . Selecting <b>2 seconds</b> or <b>10 seconds</b> delays the capturing by the specified time after you press CAMERA or ENTER.
<b>Template</b>	This item appears when you use the Picture Theme mode, allowing you to select a template.
<b>Sports Settings</b>	This item appears when you use the Sports mode. The <b>Capture Speed</b> option decides the capturing speed by selecting Slow, Moderate, or Fast. The <b>Snapshots</b> provides 3 or 5 frames for one shot.
<b>Zoom</b>	Zoom in or zoom out the object to be captured.
<b>White Balance</b>	Specify the white balance setting such as <b>Auto</b> , <b>Daylight</b> , <b>Night</b> , <b>Incandescent</b> , and <b>Fluorescent</b> to suit the lighting environment.
<b>Capture Settings</b>	Choose the Resolution to use and set the storage location (phone or storage card) for captured files. When capturing images, you can also set the Quality and enable Time Stamp. (Time Stamp only appears in Photo and Sports mode.)

Option	Allows you to
<b>Capture Mode</b>	Switch between different capture modes such as Photo, Video, Contacts Picture, and more. For details, see "Capture modes" earlier in this chapter.
<b>Effect</b>	Choose a special effect such as <b>Grayscale</b> , <b>Sepia</b> , or <b>Cool</b> to apply to your photos or video clips.
<b>Advanced</b>	Access more settings that lets you customize the Camera or Video Recorder functions. For details, see the following section "Advanced settings of the Camera Menu."
<b>Pictures &amp; Videos</b>	Open the Pictures & Videos program.

### Advanced settings of the Camera Menu

- **Capture Format.** Specify the file format for the image/video.
- **Shutter Sound.** Choose whether or not you want the camera to make a shutter sound when you press the ENTER or CAMERA button to take photos or record video clips.
- **Review Duration.** Set a time length for displaying the captured image/video on the Review screen before automatically saving it and returning to the live Camera screen. Select **No Limit** if you do not want to impose a time limit.
- **Flicker Adjustment.** When taking indoor shots, flicker on the camera screen may be caused by inconsistencies between the vertical scan rate of the camera display and the flicker frequency of fluorescent lighting. To reduce flicker, you can change the flicker adjustment setting to Auto or to the proper frequency (**50Hz** or **60Hz**) of the country where your device is being used.
- **Full Screen (Still images only).** Change the display of the Camera screen by selecting **On** or **Off**.
- **Record with Audio (Video and MMS Video only).** Select **On** to record audio with the captured video clips. This is selected by default. If you select **Off** and then capture a video clip, it will have no audio.
- **Controls.** Select **Show** or **Hide** to display or hide the indicators on the Camera screen.

- **Prefix.** Specify how to name captured images and video clips. When **Default** is selected, the file name of each new captured file is set to “IMAGE” or “VIDEO” followed by a sequential number, for example: IMAGE\_001.jpg. You may also choose to name files using either the current **Date** or **Date & Time** as the prefix.
- **Counter.** By default, the newly captured image or video files are named with a prefix and some sequential numbers, such as 001, 002, and so on. To reset the numbering to “001” for your captured files, select **Reset**.
- **Recording Limit (Video and MMS Video only).** Specify the maximum time or file size for recording.
- **Template Folder (Picture Theme only).** By default, templates are stored in the \My Documents\Templates folder on the device’s **Main Memory**. If you transferred some templates to the storage card, set this option to **Main + Card** to specify that templates are located in both the main memory and the storage card.
- **Adjust.** This option allows you to adjust the camera display properties, such as **Contrast**, **Saturation**, **Hue**, and **Sharpness**. Press NAVIGATION up or down to select the property, and press NAVIGATION left or right to change the value.

## 7.2 Using Pictures & Videos

The Pictures & Videos program allows you to view pictures and play GIF animation files and video clips on your phone. You can also view the pictures as a slide show, beam them, send them via a messaging program, edit them, or set them as the background on the Home Screen.

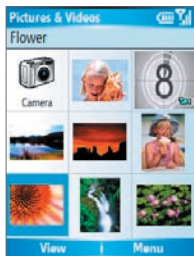

### To copy a picture or video clip to your phone

You can copy pictures from your PC and view them on your phone.

- Copy the pictures and video files from your PC or a storage card to the My Pictures folder on your phone.

For more information about copying files from your PC to your phone, see ActiveSync Help on your PC.

**Note** You can also copy pictures and video files from your PC to your phone using a memory card. Insert the memory card into the memory card slot on your phone, and then copy them from your PC to the folder you created on the memory card.

### To view pictures

1. On the Home screen, click **Start > Pictures & Videos**. The images in the My Pictures folder appear as thumbnails by default.
2. Select a picture and click **View**.

If you cannot find a picture in the default My Pictures folder, click **Menu > Folders > My Device** to go to other folders.

### To play GIF animation files

1. On the Home screen, click **Start > Pictures & Videos**.
2. Select the GIF animation file and click **View**.

### To play videos

1. On the Home screen, click **Start > Pictures & Videos**. Video files appear as thumbnails with a  icon.
2. Select a video and click **Play** to play it with the built-in Windows Media Player.

### To view slide shows

You can view your pictures as a slide show on your phone. Pictures are shown in full-screen view with 5-second intervals between slides.

1. On the Home screen, click **Start > Pictures & Videos**.
2. Click **Menu > Play Slide Show**.

**Note** You can specify how pictures are scaled to optimize their display in a slide show. Click **Menu > Options**, select **Slide Show**, and choose either **Portrait pictures** or **Landscape pictures**. You can even set your phone to play a screensaver on its monitor while your phone is connected to the PC and idle for 2 minutes.

### To start the camera from Pictures & Videos

- On the My Pictures folder, click **Camera**.

### To delete a picture or video clip

- Select a picture or video clip on the Pictures & Videos screen, and click **Menu > Delete**. Click **Yes** to confirm the deletion.

### To edit a picture

You can rotate, crop, and adjust the brightness and color contrast of your pictures.

1. On the Home screen, click **Start > Pictures & Videos**.
2. Select the picture you want to edit, click **View**.
3. Click **Menu > Edit**, and do any of the following:
  - To rotate a picture 90 degrees, click **Menu > Rotate**.
  - To crop a picture, click **Menu > Crop**. Then, drag the cursor to position it on the first corner of the cropping area, and click **Next**. Select the second corner with the area to crop and click **Finish**, or click **Previous** to go back to the previous screen and select again.
  - To auto-adjust the brightness and contrast levels of a picture, click **Menu > Auto Correct**.
4. On the Edit screen, click **Menu > Save As** to save the edited picture with a new name or at a new location.

**Note** To undo an edit, click **Menu > Undo**. To cancel all unsaved edits you made to the picture, click **Menu > Cancel**.

### To set a picture as the Home screen background

1. On the Home screen, click **Start > Pictures & Videos**.
2. Select the picture you want to set as the background.
3. Click **View**.
4. Click **Menu > Use as Home Screen**.
5. Select the display area and click **Next**.
6. Adjust the transparency. Select a higher percentage for a more transparent picture, or a lower percentage for a more opaque picture.
7. Click **Finish**.

### To send pictures and video clips via e-mail

You can send pictures and video clips to other phones via e-mail.

1. First, set up Messaging to send and receive messages.
2. On the Pictures & Videos screen, select the item you want to send.
3. Click **Menu > Send**.
4. On the Messaging screen, select **Outlook E-mail** and click **Select**.

A new message is created with the item attached.

5. Enter the recipient name and subject, and click **Send**.  
The message will be sent the next time you synchronize your phone.

**Note** Pictures and video clips are saved automatically before they are sent.

### To beam pictures

You can beam a picture to your friends or family by using Bluetooth technology.

1. On the Home screen, click **Start > Pictures & Videos**.
2. Select the picture you want to beam.
3. Click **Menu > Beam**.
4. Select the device to which you want to send the picture.
5. Click **Beam**.



### To assign pictures to contacts

You can assign a picture to a contact so that you can easily identify the contact at any time.

1. On the Home screen, click **Start > Pictures & Videos**.
2. Select the picture you want to assign to a contact.
3. Click **Menu > Save > Save to Contact**.
4. Select the contact, and click **Select**.

### To customize picture options

1. On the Home screen, click **Start > Pictures & Videos**.
2. Select the picture for which you want to configure advanced options.
3. Click **Menu > Options**.
4. Select **General** or **Slide Show** on the Options screen then press ENTER.

The **General** option allows you to do the following:

- Decrease the picture size so that photos can be sent faster via e-mail.
- Set the direction to rotate a picture.

The **Slide Show** option allows you to do the following:

- Configure the view settings during slide shows.
- Activate screensaver.

## 7.3 Using Windows Media Player

You can use Microsoft® Windows Media™ Player Mobile for Smartphone to play digital audio and video files that are stored on your phone or on a network, such as on a Web site.

In this documentation, the version of Windows Media Player for Windows-based PCs is called the “desktop Player” and the version for Smartphone is called the “device Player.”



These are the following file formats that are supported by this version of Windows Media Player Mobile.

### Formats Supported

### File Extensions

#### Video

- Windows Media Video .wmv, .asf
- MPEG4 Simple Profile .mp4
- H.263 .3gp
- Motion JPEG .avi

#### Audio

- Windows Media Audio .wma
- MP3 .mp3
- MIDI .mid, .midi, .rmi
- AMR Narrow Band .amr
- AMR Wide Band .awb
- AAC .m4a

## About the controls

By default, these hardware buttons are assigned to Windows Media Player Mobile functions.

To	Press
Play or pause	ENTER
Skip to a previous file	NAVIGATION left
Skip to the next file	NAVIGATION right
Increase the volume	NAVIGATION up
Decrease the volume	NAVIGATION down
Turn the sound on or off quickly (mute)	#
Switch to full screen during video playback	0
Change rating	*
Fast-forward a file	NAVIGATION right (hold)
Rewind a file	NAVIGATION left (hold)

## About the screens and menus

Windows Media Player has three primary screens:

**Playback screen.** The default screen that displays the playback controls (such as Play, Pause, Next, Previous, and Volume) and the video window. You can change the appearance of this screen by choosing a different skin.

**Now Playing screen.** The screen that displays the Now Playing playlist. This special playlist indicates the current file being played and files that are queued up to play next.

**Library screen.** The screen that lets you quickly find your audio files, video files, and playlists. It contains categories such as My Music, My Videos, My TV, and My Playlists.

At the bottom of each screen is a **Menu**. The commands on this menu vary, depending upon which screen you are viewing.

### Playback screen menu

When you are viewing the Playback screen, these options appear on the **Menu**.

Option	Allows you to
<b>Library</b>	Display the Library screen so you can choose a file to play.
<b>Play/Pause</b>	Start or pause playback.
<b>Stop</b>	Stop playback.
<b>Shuffle/Repeat &gt; Shuffle</b>	Play the items in the Now Playing playlist in random order.
<b>Shuffle/Repeat &gt; Repeat</b>	Play the items in the Now Playing playlist repeatedly.
<b>Full Screen</b>	When a video is playing, display it by using the entire screen.
<b>Options</b>	Adjust various Windows Media Player Mobile options, including network, skin, and hardware button options.
<b>Properties</b>	Display information about the currently playing file.
<b>About</b>	Display information about Windows Media Player Mobile, such as the version number.

### Now Playing screen menu

When you are viewing the Now Playing screen, these options appear on the **Menu**.

Option	Allows you to
<b>Library</b>	Display the Library screen so you can choose a file to play.
<b>Move Up</b>	Move the selected item up in the playlist order.
<b>Move Down</b>	Move the selected item down in the playlist order.
<b>Remove from Playlist</b>	Remove the selected item from the playlist.
<b>Shuffle/Repeat &gt; Shuffle</b>	Play the items in the Now Playing playlist in a random order.
<b>Shuffle/Repeat &gt; Repeat</b>	Play the items in the Now Playing playlist repeatedly.
<b>Clear Now Playing</b>	Remove all items from the Now Playing playlist.
<b>Error Details</b>	View error information about the selected item (an exclamation mark appears before the item name if error details are available).
<b>Properties</b>	View information about the selected file.

## Library screen menu

When you are viewing the Library screen, these options appear on the **Menu**.

Option	Allows you to
<b>Queue Up</b>	Add the selected item to the end of the current (Now Playing) playlist.
<b>Delete from Library</b>	Delete the selected item from the library.
<b>Now Playing</b>	Display the Now Playing playlist.
<b>Library &gt; library name</b>	Switch between libraries, such as between <b>My Device</b> and <b>Storage Card</b> .
<b>Update Library</b>	Add new items to the library by searching your phone or storage card.
<b>Open File</b>	Find and play files that are stored on your phone or storage card but that are not in the library.
<b>Open URL</b>	Play a file on a network, such as the Internet.
<b>Properties</b>	View information about the selected file.

## About licenses and protected files

Some content (such as digital media files downloaded from the Internet, CD tracks, and videos) have associated licenses that protect them from being unlawfully distributed or shared. Licenses are created and managed by using digital rights management (DRM), which is the technology for securing content and managing its access rights. Some licenses may prevent you from playing files that have been copied to your phone. Files that have licenses associated with them are called “*protected files*.”

If you want to copy a protected file from your PC to your phone, use the desktop Player to synchronize the file to your phone (instead of dragging the file from a folder on your PC to a folder on your phone, for example). This will ensure that the license is copied along with the protected file. For more information about synchronizing files to your phone and other mobile devices, see the desktop Player Help.

**Note** You can view the protection status for a file by checking its file properties (**Menu > Properties**).

## Copy files to your phone

Use the **Sync** feature in the desktop version of Windows Media Player to synchronize (copy) digital media files from your PC to your phone. Using **Sync** ensures that protected files and album art (for skins) are copied to your phone correctly.

### To synchronize content to your phone automatically

1. On your PC, start Windows Media Player.
2. Insert a 32-MB or larger storage card into your phone, and then connect your phone to your PC.
3. If you have not set up synchronization between your phone and PC, the Device Setup Wizard opens on your PC.
4. In the wizard, click **Automatic**, select the **Customize the playlists that will be synchronized** check box, and then select the playlists that you want to synchronize.
5. Click **Finish**.
6. The files begin synchronizing to your phone. The next time you connect your phone to your PC while the desktop version of Windows Media Player is running, synchronization will start automatically.

### To synchronize and copy content manually to your phone

1. If you have not set up synchronization between your phone and PC, follow steps 1 to 5 in “To synchronize content to your phone automatically,” except that you should click **Manual** synchronization.
2. To choose files to synchronize and copy to your device, do the following:
  - Click the **Library** tab.
  - In the rightmost pane, click the drop-down list and select **Sync List**.
  - In the Playlist which is the leftmost pane, select a desired playlist.

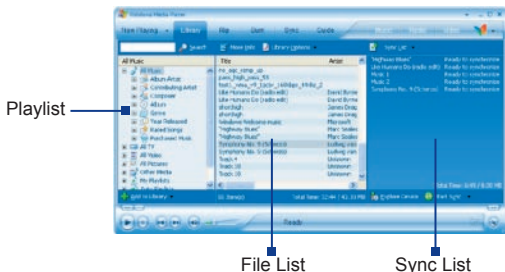

- In the File List which is the middle pane, multi-select desired files and then drag them to the Sync List.
- Click the **Start Sync** button found at the bottom of the Sync List.

### Notes

- Always use the desktop version of Windows Media Player 10 to synchronize (copy) files to your phone. For example, do not use Windows Explorer to drag and drop files from your computer to your phone.
- Always synchronize files to a storage card that is inserted into your phone. Do not synchronize to a storage card that is inserted into a storage card reader.
- Audio files copy faster if the desktop Player is configured to automatically set the quality level for audio files copied to your phone. For more information, see the desktop Player Help.
- The desktop version of Windows Media Player 10 is only available for computers running Windows XP. If you are not running Windows XP on your PC, use the **Copy to CD or Device** feature of Windows Media Player 9 Series to copy your audio files and video files to your phone.
- The desktop version of Windows Media Player 9 Series is not as full-featured as the desktop version of Windows Media Player 10. For example, the desktop version of Windows Media Player 9 Series does not support automatic synchronization, synchronization of playlists, synchronization of album art, or synchronization of TV shows recorded by computers running Windows XP Media Center Edition.
- For more information about the **Copy to CD or Device** feature, start the desktop version of Windows Media Player 9 Series, and then press F1.

## Play media

### To play media on your phone

Use the library to find and play songs, videos, and playlists that are stored on your phone or removable storage card.

1. If you are not on the Library screen, click **Menu > Library**.
2. If necessary, on the Library screen, click **Menu > Library**, and then select the library that you want to use (for example, **Storage Card**).
3. In most cases, Windows Media Player Mobile automatically updates the library. However, you can manually update the library to ensure that it contains new files that you recently copied to your device or storage card. Tap **Menu > Update Library** to manually update the library list.
4. Select a category (for example, **My Music** or **My Playlists**), select the item that you want to play (such as a song, album, or artist name), and then click **Play**.

**Note** To play a file that is stored on your phone but is not in a library, on the Library screen, click **Menu > Open File**. Select the item that you want to play (such as a file or a folder), and click **Play**.

### To play media on a network

Use the **Open URL** command to play a song or video that is stored on the Internet or on a network server.

1. If you are not on the Library screen, click **Menu > Library**.
2. Click **Menu > Open URL**.
3. Do one of the following:
  - In **URL**, enter a network address.
  - In **History**, select a URL that you have previously used.

**Note** To play media on a network, your phone must be connected to a network.



## Change Player appearance

You can change the appearance of the Playback screen by choosing a new skin.

1. If you are not on the Playback screen, press **BACK** to display the Playback screen.
2. Click **Menu > Options > Skins**.
3. To select a skin, press **NAVIGATION** left or right until you find the skin that you want to use.
4. Click **Done**.

### Notes

- To download new skins, see the [WMplugins.com](http://www.wmplugins.com) site (<http://www.wmplugins.com>).
- After downloading a skin to your computer and unzipping it if necessary, use ActiveSync to copy the .skn and .bmp files to your phone (such as to the location, **SmartphoneProgram Files\Windows Media Player**, on the phone). To ensure that skins appear on the **Skins** tab, do not store skin files in the **Windows** folder on your phone.

## Troubleshooting

If you encounter any difficulty while using Windows Media Player Mobile, a number of resources are available on the Web to help you troubleshoot the issue, including a list of frequently asked questions (FAQ).

For more information, see the Troubleshooting Windows Media Player Mobile page at the Microsoft Web site (<http://www.microsoft.com/windows/windowsmedia/player/windowsmobile/troubleshooting.aspx>).

## 7.4 Using MIDlet Manager

MIDlets are Java-based applications that can run on mobile devices. Your phone supports Java 2 Micro Edition (J2ME). The MIDlet Manager allows you to download Java-based applications, such as games and tools that are specifically designed for mobile devices. The Java MIDlet Manager gives you the flexibility of installing and managing additional J2ME applications from the Internet.

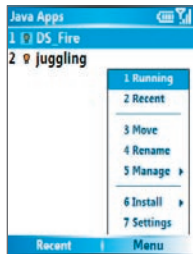

MIDlet Manager

### To install MIDlets from the Internet

1. On the Home screen, click **Start > MIDlet Manager**.  
The Java Apps screen appears.
2. Click **Menu > Install > Browse** to open Internet Explorer Mobile.
3. Locate the MIDlet/MIDlet suite while connected to the Internet.
4. Select the MIDlet/MIDlet suite to download.
5. To start installing the MIDlet/MIDlet suite, click **Yes**.
6. Click **Done** to confirm the installation.

### Notes

- You can cancel the installation at any time.
- Downloaded MIDlets will be automatically saved in the My Documents folder.

### To install MIDlets from a PC

You can install the MIDlets/MIDlet suites on your phone from a PC using the USB sync cable or Bluetooth. MIDlets copied to your phone using Bluetooth or e-mail attachments are automatically saved in the My Documents folder. However, you can copy the MIDlet file(s) from a PC to any of the following temporary folders on your phone from where MIDlet Manager can install them.

- Device memory: ../Smartphone/My Documents/My MIDlets
- Storage card: ../Smartphone/Storage Card

**Note** If the My MIDlets folder does not exist in My Documents, you can create one with the same folder name. However, a folder named Storage Card automatically appears after you insert a storage card into your phone.

### To install MIDlets from a local folder

1. On the Home screen, click **Start > MIDlet Manager**.  
The Java Apps screen appears.
2. Click **Menu > Install > Local** to install the MIDlets currently saved in the My MIDlets folder.  
Click **Recent** to view the MIDlets or a MIDlet suite used recently on your phone.
3. Select the MIDlet/MIDlet suite from the list by using the NAVIGATION control.
4. Click **Menu > Install**.
5. Click **Yes** to install.
6. Click **Done** to confirm the installation.

**Note** To remove the MIDlet files from the default folder, click **Menu > Delete**.

### To run MIDlets on your phone

1. On the Home screen, click **Start > MIDlet Manager**.  
The Java Apps screen appears.
2. Select a MIDlet from the list by using the NAVIGATION control.
3. Press the ENTER button to run the MIDlet.

### To view the MIDlets currently running

- On the MIDlet Manager Java Apps screen, click **Menu > Running**.

**Note** To view the most recently used MIDlets, click **Menu > Recent**.

### To stop running a MIDlet

1. On the Home screen, click **Start > MIDlet Manager**.  
The Java Apps screen appears.

2. Click **Menu > Running**.
3. Select a MIDlet on the Running MIDlets screen, and click **Menu > Stop**.

**Note** To stop all MIDlets currently running on your phone, click **Menu > Stop All**.

## Manage MIDlets

You can organize the MIDlets into groups and define custom groups. You can also change the default display settings for a MIDlet.

### To customize the display settings

1. On the Home screen, click **Start > MIDlet Manager**.  
The Java Apps screen appears.
2. Click **Menu > Settings**.
3. On the Settings screen, select Display Options by using the NAVIGATION control.
4. Press the ENTER button.
5. In **View Options**, choose to display the MIDlets either in groups or all at once.
6. In **Sort Options**, choose to sort by Name or by Size.
7. Click **Done**.

### To change the display name of a MIDlet

1. On the Home screen, click **Start > MIDlet Manager**.  
The Java Apps screen appears.
2. Select a MIDlet by using the NAVIGATION control.
3. Click **Menu > Rename**.
4. Enter a new name for the MIDlet.
5. Click **Done**.

**Note** You cannot change the name of a MIDlet suite.

### To uninstall a MIDlet

Before you uninstall a MIDlet/MIDlet suite, make sure that it is not running.

1. On the Java Apps screen, select the MIDlet/MIDlet suite by using the NAVIGATION control.
2. Click **Menu > Manage > Uninstall**.
3. Click **OK** to confirm.

**Note** You cannot uninstall a single MIDlet from a MIDlet suite; you must uninstall the complete MIDlet suite.

### To check storage space

1. On the Home screen, click **Start > MIDlet Manager**.
2. Select a MIDlet by using the NAVIGATION control.
3. On the Java Apps screen, click **Menu > Settings**.
4. On the Settings screen, select **System Info** by using the NAVIGATION control.
5. Press the ENTER button to see how much phone storage space is used by the MIDlet.
6. Click **OK**.

### To select a network type

1. On the Java Apps screen, click **Menu > Settings**.
2. Select **Choose Network Type** by using the NAVIGATION control.
3. Choose a network type from the list.
4. Click **Select**.

### To configure MIDlet security

You can adjust security settings for each MIDlet/MIDlet suite.

1. On the Java Apps screen, select a MIDlet by using the NAVIGATION control.
2. Click **Menu > Manage > Security**.
3. Configure the security options, such as **Local Connectivity**, **App Auto Run**, **Messaging**, and so on.

Please note that some features may not be available for all MIDlets/MIDlet suites. Following are the security options that you can set for a running MIDlet/MIDlet suite.

Security Option	Description
<b>Net Access</b>	Determines whether a MIDlet/MIDlet suite can access the Internet.
<b>Local Connectivity</b>	Enables a MIDlet/MIDlet suite to access services, such as Bluetooth.
<b>App Auto Run</b>	Enables a MIDlet/MIDlet suite to run at specified times, or any time.
<b>Messaging</b>	Determines whether a MIDlet/MIDlet suite can send and/or receive text (SMS, Short Message Service) messages.
<b>Multimedia Recording</b>	Enables a MIDlet/MIDlet suite to record sounds and images.

## Error messages

The following is a list of error messages that you may receive while managing and using MIDlets/MIDlet suites on your phone.

Error Message	Description
<b>Either RAM shortage, or insufficient space on the file system.</b>	There is insufficient memory on your phone.
<b>Network out.</b>	There is no network connection available.
<b>The jar size does not match that specified in the jad.</b>	The installation information provided by the MIDlet manufacturer is inaccurate.
<b>The jar manifest does not match the jad.</b>	The installation information provided by the MIDlet manufacturer is inaccurate.
<b>Invalid Java application descriptor (jad).</b>	There is a problem with the installation file provided by the MIDlet manufacturer.
<b>Invalid Java archive (jar).</b>	There is a problem with the installation file provided by the MIDlet manufacturer.
<b>This Java application is not compatible with this device.</b>	One or more features required by this MIDlet is not available on your phone.

# Chapter 8

## Using Other Applications

**8.1 Using ClearVue Suite**

**8.2 Using Speed Dial**

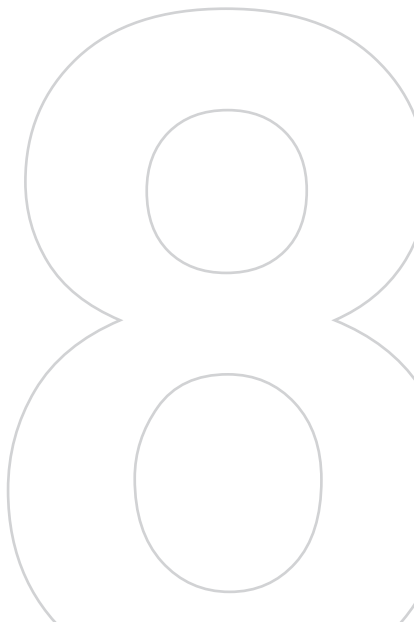

## 8.1 Using ClearVue Suite

ClearVue Suite consists of four applications that let you view various types of documents such as Word documents, Powerpoint presentation files, Excel worksheets, and Acrobat PDF files. The ClearVue Suite consists of the following:

- ClearVue Presentation (displays PowerPoint files)
- ClearVue Worksheet (displays Excel files)
- ClearVue Document (displays Word files)
- ClearVue PDF (displays Acrobat/PDF files)

**Note** Not all fonts, colors, features, and versions of the desktop versions of PowerPoint, Word, Excel, and Acrobat are supported, but ClearVue will show a close approximation.

### ClearVue Presentation

ClearVue Presentation is a complete PowerPoint viewer solution with the ability to view native PowerPoint presentations. With ClearVue Presentation, you will see the original presentation complete with animations and transitions.

**Note** ClearVue Presentation only supports Powerpoint files created in Office 97 or later versions.

#### To open a presentation file

1. Click **File > Open** and then locate the **.ppt** or **.pps** file.
2. Click **Open**.

#### To change the view

ClearVue Presentation lets you view your presentation file in 3 modes. Click **View** and select either Normal, Slide Sorter or Notes.

- **Normal.** Displays a large single image of the current slide and below it, small thumbnail images of other slides in the presentation.
- **Slide Sorter.** Slides will be displayed as small thumbnails.
- **Notes.** Lets you to view any slide notes that might have been stored in the original presentation.



### To change the zoom ratio of the view mode

- Click **View > Scale**.

**Note** This only applies to Normal and Notes view modes.

### To set up your presentation show

1. Click **View > Set Up Show**.
2. In **Advance Slides**, select how you want to advance to the next slide.
  - **Manually.** Press NAVIGATION right to advance through the slides.
  - **Use timings.** Uses the timing information stored in the PowerPoint file to determine when to display the next slide.
  - **Automatically.** Automatically advances to the next slide based on the time set in **after \_\_ secs**.

**Tip** Click **Loop continuously** to loop the presentation. You need to manually stop the presentation. To learn how to stop the presentation, see “To view your presentation.”

3. Select the **Orientation** when viewing the presentation.
4. Click **Black slide at end** to add a blank slide after the last slide in the presentation.

### To set up a custom show

1. Click **View > Custom Show**.
2. In **Show List**, select the slide you want to edit and then click **Menu**. In the Menu options, you can choose to either add, delete, hide, move up or move down the slide.

**Tip** Click **Reset** to revert the presentation back to its original state.

### To set up a custom show

- Click **View > View Show**.

**Tip** While viewing the presentation, press the **\_#** key to open a menu allowing you to go to the next/previous slide, go to a specific slide, or end the presentation.

## ClearVue Worksheet

ClearVue Worksheet gives you the ability to view native Excel worksheets. It also lets you view embedded charts and chart sheets as well.

### Notes

- ClearVue Worksheet only supports Excel files created in Office 97 or later versions.
- Excel macros that might be in the original file will not run when loaded.
- Three-dimensional charts will be mapped into a two-dimensional space.
- Worksheet does not display images selected as a background in an AutoShape.
- Worksheet cannot open files that have been password protected using the “Save Options” password setting in Microsoft Excel.

### To open a worksheet file

1. Click **File > Open** and then locate the **.xls** file.
2. Click **Open**.

### To change the zoom ratio

- Click **View** and select a magnification.

### To view another sheet in your worksheet file

- Click **View > Sheet** and select the sheet you want to view.

## ClearVue Document

ClearVue Document lets you view Word documents, complete with tables, images, columns, bulleted lists, and more.

**Note** ClearVue Document only supports Word files created in Office 97 or later versions.

### To open a document file

1. Click **File > Open** and then locate the **.doc** or **.rtf** file.
2. Click **Open**.

After you open a file in ClearVue Document, it initially displays using the default **Page Width** setting. This means that the page is sized to fit within the available area of your Smartphone's screen.

Click **Zoom** to change the magnification as desired, then scroll through and view the document using the NAVIGATION buttons on your Smartphone.

## ClearVue PDF

ClearVue PDF lets you view PDF files on your Smartphone.

### To open a PDF file

1. Click **File > Open** and then locate the **.pdf** file.
2. Click **Open**.

After you open a file in ClearVue PDF, it initially displays using the default Page Width setting. This means that the page is sized to fit within the available area of your Smartphone's screen.

Click **Zoom** to change the magnification as desired, then scroll through and view the PDF document using the NAVIGATION buttons on your Smartphone.

## 8.2 Using Speed Dial

You can create speed dial entries for frequently-called numbers or frequently-accessed items so you can dial a number or access an item by pressing a single key.

### To create a speed dial entry for a contact

1. On the Home screen, click **Start > Contacts**.
2. Select a contact.
3. Press ENTER to view the contact details.
4. Select the desired phone number and click **Menu > Add to Speed Dial**.
5. Enter appropriate details in Name, Value, and Keypad assignment.
6. Click **Done**. To quit at any time during this process, click **Menu > Cancel**.

**Note** Speed dials can be created only for numbers that are stored in Contacts.

### To create a speed dial entry for an item

1. On the Home screen, click **Start** and choose (just highlight) the desired item.
2. Click **Menu > Add Speed Dial**.
3. Enter details in Name, Value, and Keypad assignment.
4. Click **Done**. To quit at any time during this process, click **Menu > Cancel**.

**Note** The first speed dial location is generally reserved for your voice mail. Speed Dial uses the next available location by default. If you want to place a number in a location that is already used, the new number replaces the existing number.

### To retrieve a voice mail message

- On the Home screen, press and hold the **1** key on the keypad to access your voice mailbox, and follow the prompts to retrieve your messages.

### To make a call or launch a program using Speed Dial

- If you have assigned a speed dial (for example, the second location) to a contact or a program in Speed Dial, you can simply press and hold the **2** key on the Phone keypad to dial the contact's number or launch the program.

### To delete a speed dial entry

1. On the Home screen, click **Start > Speed Dial**.
2. Select the desired entry and click **Menu > Delete**.

## Create voice tags

With Speed Dial, you can also record a voice tag for a phone number, e-mail address, or Web page address that is stored in Contacts. Then, when you say the voice tag, your phone automatically dials the associated phone number, opens an e-mail message using the associated address, or goes to the associated Web page.

### To create a voice tag for a phone number, e-mail address, or URL in Contacts

1. On the Home screen, click **Start > Contacts**.
2. Select the desired contact, and press ENTER to open the contact card.
3. Select the item to which you want to assign a voice tag.
4. Click **Menu > Add Voice Tag**.
5. After a "beep" sound, begin recording the voice tag (preferably one easy-to-recognize word).
6. When the voice tag is successfully trained, the phone will play back the voice tag. Click **OK**.
7. Enter appropriate details in Name, Value, and Keypad assignment. Click **Done** to save the new voice tag. To quit at any time during this process, click **Menu > Cancel**.

### To create a voice tag for a program

To create a voice tag for a program, for example, Calendar, do the following:

1. On the Home screen, click **Start** and select (just highlight) the **Calendar** item.
2. Click **Menu > Add Voice Tag**.
3. After a “beep” sound, say “Calendar.”
4. When the voice tag is successfully trained, the phone will play back the voice tag. Click **OK**.
5. Enter appropriate details in Name, Value, and Keypad assignment. Click **Done** to save the new voice tag. To quit at any time during this process, click **Menu > Cancel**.

### To edit, delete, and play voice tags

- On the Home screen, click **Start > Speed Dial**.
- Select the desired voice tag from the list.
- Do any of the following:
  - To change the voice tag, click **Edit** and make changes, then click **Done**.
  - To delete the voice tag, click **Menu > Delete**.
  - To play back an existing voice tag at any time, click **Menu > Play Voice Tag**.

### To make a call or launch a program using the voice tag

1. On the Home screen, press and hold the VOLUME down button on the left side of the phone for two seconds.
2. After a “beep” sound, say the recorded voice tag that you have assigned to the phone number you want to call or the program you want to launch. The phone plays back the voice tag and then dials or launches the associated program.

**Tip** If the phone cannot recognize your voice tag, please try again and speak clearly and reduce the surrounding noise.

# Appendix

**A.1 Regulatory Notices**

**A.2 PC Requirement to Run ActiveSync 4.x**

**A.3 Specifications**

## A.1 Regulatory Notices

### Regulatory Agency IDs

For regulatory identification purposes, your product is assigned a model number of STAR101.

To ensure continued reliable and safe operation of your device, use only the accessories listed below with your STAR101.

The Battery Pack has been assigned a model number of STAR160.

This product is intended for use with a certified Class 2 Limited Power Source, rated 5 Volts DC, maximum 1 Amp power supply unit.

### European Union Notice

Products with CE marking comply with the R&TTE Directive (99/5/EC), the EMC Directive (89/336/EEC) and the Low Voltage Directive (73/23/EEC) issued by the Commission of the European Community.

Compliance with these directives implies conformity to the following European Norms:

- EN 60950-1 (IEC 60950-1) – Safety of Information Technology Equipment.
- ETSI EN 300 328 Electromagnetic compatibility and Radio spectrum Matters (ERM); Wideband Transmission systems; data transmission equipment operating in the 2.4 GHz ISM band and using spread spectrum modulation techniques.
- ETSI EN 301 511 – Global System for Mobile communications (GSM); Harmonized standard for mobile stations in the GSM 900 and DCS 1800 bands covering essential requirements under article 3.2 of the R&TTE directive (1999/5/EC).
- ETSI EN 301 489-1 Electromagnetic compatibility and Radio spectrum Matters (ERM); ElectroMagnetic Compatibility (EMC) standard for radio equipment and services; Part 1: Common technical requirements.
- ETSI EN 301 489-7 – Electromagnetic compatibility and Radio spectrum Matters (ERM); ElectroMagnetic Compatibility (EMC) for radio equipment and services; Part 7: Specific conditions



for mobile and portable radio and ancillary equipment of digital cellular radio telecommunications systems (GSM and DCS).

- ETSI EN 301 489-17 Electromagnetic compatibility and Radio spectrum Matters (ERM); ElectroMagnetic Compatibility (EMC) standard for radio equipment and services; Part 17: Specific conditions for 2.4 GHz wideband transmission systems.
- EN 50360 - 2001 – Product standard to demonstrate the compliance of mobile phones with the basic restrictions related to human exposure to electromagnetic fields (300 MHz ~ 3 GHz).

## **Safety precautions for RF exposure**

Use only original manufacturer-approved accessories, or accessories that do not contain any metal

Use of non-original manufacturer-approved accessories may violate your local RF exposure guidelines and should be avoided.

### **Heed service markings**

Except as explained elsewhere in the Operating or Service documentation, do not service any product yourself. Service needed on components inside these compartments should be done by an authorized service technician or provider.

### **Damage requiring service**

Unplug the product from the electrical outlet and refer servicing to an authorized service technician or provider under the following conditions:

- Liquid has been spilled or an object has fallen into the product.
- The product has been exposed to rain or water.
- The product has been dropped or damaged.
- There are noticeable signs of overheating.
- The product does not operate normally when you follow the operating instructions.

### Exposure to radio frequency (RF) signals

Your wireless phone is a radio transmitter and receiver. It is designed and manufactured not to exceed the emission limits for exposure to radio frequency (RF) energy. These limits are part of comprehensive guidelines and establish permitted levels of RF energy for the general population. The guidelines are based on the safety standards previously set by international standards bodies:

- American National Standards Institute (ANSI) IEEE. C95.1-1992
- National Council on Radiation Protection and Measurement (NCRP). Report 86. 1986
- International Commission on Non-Ionizing Radiation Protection (ICNIRP) 1996
- Ministry of Health (Canada), Safety Code 6. The standards include a substantial safety margin designed to assure the safety of all persons, regardless of age and health.

The exposure standard for wireless mobile phones employs a unit of measurement known as the **Specific Absorption Rate**, or SAR.

The standard incorporates a substantial margin of safety to give additional protection for the public and to account for any variations in usage. Normal conditions only ensure the radiative performance and safety of the interference. As with other mobile radio transmitting equipment, users are advised that for satisfactory operation of the equipment and for the safety of personnel, it is recommended that no part of the human body be allowed to come too close to the antenna during operation of the equipment.

### SAR Information

- 0.356 mW/g @ 10g (CE)

CE0678

## **Telecommunications & Internet Association (TIA) safety information**

### **Pacemakers**

The Health Industry Manufacturers Association recommends that a minimum separation of six inches be maintained between a handheld wireless phone and a pacemaker to avoid potential interference with the pacemaker. These recommendations are consistent with the independent research by and recommendations of Wireless Technology Research. Persons with pacemakers:

- Should ALWAYS keep the phone more than six inches from their pacemaker when the phone is turned ON.
- Should not carry the phone in a breast pocket.
- Should use the ear opposite the pacemaker to minimize the potential for interference. If you have any reason to suspect that interference is taking place, turn your phone OFF immediately.

### **Hearing Aids**

Some digital wireless phones may interfere with some hearing aids. In the event of such interference, you may want to consult your service provider, or call the customer service line to discuss alternatives.

### **Other Medical Devices**

If you use any other personal medical device, consult the manufacturer of your device to determine if they are adequately shielded from external RF energy. Your physician may be able to assist you in obtaining this information.

Turn your phone OFF in health care facilities when any regulations posted in these areas instruct you to do so. Hospitals or health care facilities may be using equipment that could be sensitive to external RF energy.

### **Other tips and cautions**

- Avoid using your phone near metal structures (for example, the steel frame of a building).
- Avoid using your phone near strong electromagnetic sources, such as microwave ovens, sound speakers, TV and radio.
- Avoid using your phone after a dramatic change in temperature.

## WEEE Notice

The Directive on Waste Electrical and Electronic Equipment (WEEE), which entered into force as European law on 13th February 2003, resulted in a major change in the treatment of electrical equipment at end-of-life.

The purpose of this Directive is, as a first priority, the prevention of WEEE, and in addition, to promote the reuse, recycling and other forms of recovery of such wastes so as to reduce disposal.

The WEEE logo on the product or on its box indicates that this product must not be disposed of or dumped with your other household waste. You are liable to dispose of all your electronic or electrical waste equipment by relocating over to the specified collection point for recycling of such hazardous waste. Isolated collection and proper recovery of your electronic and electrical waste equipment at the time of disposal will allow us to help conserving natural resources. Moreover, proper recycling of the electronic and electrical waste equipment will ensure safety of human health and environment. For more information about electronic and electrical waste equipment disposal, recovery, and collection points, please contact your local city centre, household waste disposal service, shop from where you purchased the equipment, or manufacturer of the equipment.



## RoHS Compliance

This product is in compliance with Directive 2002/95/EC of the European Parliament and of the Council of 27 January 2003, on the restriction of the use of certain hazardous substances in electrical and electronic equipment (RoHS) and its amendments.

## A.2 PC Requirement to Run ActiveSync 4.x

To connect your device to the PC, you have to install Microsoft® ActiveSync® program on your PC. ActiveSync 4.x is included in the Installation CD, which is compatible with the following operating systems and applications:

- Microsoft® Windows® 2000 Service Pack 4
- Microsoft® Windows® Server 2003 Service Pack 1
- Microsoft® Windows® Server 2003 IA64 Edition Service Pack 1
- Microsoft® Windows® Server 2003 x64 Edition Service Pack 1
- Microsoft® Windows® XP Professional Service Packs 1 and 2
- Microsoft® Windows® XP Home Service Packs 1 and 2
- Microsoft® Windows® XP Tablet PC Edition 2005
- Microsoft® Windows® XP Media Center Edition 2005
- Microsoft® Windows® XP Professional x64 Edition
- Microsoft® Outlook® 98, Microsoft® Outlook® 2000 and Microsoft® Outlook® XP, and Microsoft® Outlook® 2003 messaging and collaboration clients
- Microsoft® Office 97, excluding Outlook
- Microsoft® Office 2000
- Microsoft® Office XP
- Microsoft® Office 2003
- Microsoft® Internet Explorer 4.01 or later (required)
- Microsoft® Systems Management Server 2.0

## A.3 Specifications

System information	
<b>Processor</b>	TI OMAP 850, 195 MHz
<b>Memory</b>	<ul style="list-style-type: none"><li>• ROM: 64 MB (Standard)</li><li>• RAM: 64 MB (Standard)</li></ul>
<b>Operating system</b>	Microsoft Windows Mobile™ Version 5.0 for Smartphone

---

Display	
<b>Main screen</b>	2.2" TFT-LCD, 320 x 240 at 65K colors
<b>External screen</b>	1.2" TFT-LCD, 128 x 128 at 65K colors

GSM/GPRS/EDGE Quad-band module	
<b>GSM 850</b>	824 ~ 849, 869 ~ 894MHz
<b>GSM 900</b>	880 ~ 915, 925 ~ 960 MHz
<b>GSM 1800</b>	1710 ~ 1785, 1805 ~ 1880 MHz
<b>GSM 1900</b>	1850 ~ 1910, 1930 ~ 1990 MHz

Camera module	
<b>Type</b>	1.3 mega-pixel Color CMOS
<b>Resolution</b>	<ul style="list-style-type: none"><li>• SXGA: 1280 x 1024</li><li>• VGA: 640 x 480</li><li>• QVGA: 320 x 240</li><li>• QQVGA: 160 x120</li></ul>

Connection	
<b>I/O port</b>	12-pin connector for signals (for audio, USB and power)
<b>Bluetooth</b>	V1.2, Class 2 transmit power

**Audio**

**Microphone/speaker** Built-in microphone and 3-in-1 speaker

**Headphone** AAC/AMR/WMA/WAV/MP3 codec

**Physical**

**Dimension** 98.5mm(L) x 51.4mm(W) x 15.8mm(T)

**Weight** 99g with battery pack

**Controls and lights**

**Navigation** 5-way navigation pad/ENTER button

**Buttons**

- Three Music keys: Play/Pause, FF, and RW
- Two program buttons: Voice Notes / Voice Tag (left side) and CAMERA (right side)
- Volume Up button (left upper side)
  - Press to adjust volume up
- Volume Down button (left lower side)
  - Press to adjust volume down
- Two SOFT KEYS
- HOME button
- BACK button
- TALK button (start call/answer call)
- END button (end call/power on and off)
- 12-button dialing keypad

**Lights**

- Event notification
  - Charge status
  - GSM/GPRS signals
  - Bluetooth connection
-

**Expansion slot**

<b>SD slot</b>	Micro SD memory card
----------------	----------------------

---

**Power supply**

<b>Battery</b>	750mAh (typical) Lithium-Ion removable, rechargeable battery
----------------	--

<b>AC adapter</b>	<ul style="list-style-type: none"><li>• AC input/frequency: 100 ~ 240 VAC, 50/60Hz</li><li>• Rated output: 5VDC, 1A (typical)</li></ul>
-------------------	---



# Index

**A**

- Accessibility settings
  - confirmation time out 56
  - in-call alert volume 56
  - multipress time out 56
  - system font size 56
- ActiveSync 22
  - install and set up 40
  - overview 40
  - synchronize 43
- Add and remove programs 58
- Alarm 55
- Alarm settings 53
- Alerts 53
- Answer/end call 34
- Answer Mode 52
- Attachments 92

**B**

- Backlight time out 56
- Back up files 61
- Battery 28
  - battery management 56
  - check battery power 28
  - optimize power performance 28
- Beam
  - via Bluetooth 83
- Bluetooth
  - beaming 83
  - Bluetooth modem 85
  - discoverable 79
  - modes 79
  - overview 79
  - partnerships 80
  - synchronize 47

**C**

- Calculator 22
- Calendar 22, 105
- Call History 22
- Camera 22
  - camera button 116
  - icons and indicators 118
  - main menu 123
  - zoom 122
- Capture formats 117
- Capture modes 117
- ClearVue Suite 144
  - ClearVue Document 146
  - ClearVue PDF 147
  - ClearVue Presentation 144
  - ClearVue Worksheet 146
- Clear Storage 22
- Close running programs 60
- Comm Manager 22, 78
- Compose
  - e-mail/SMS message 91
  - MMS message 100
  - MMS message from template 101
- Conference call 35
- Confirmation time out 56
- Connect notebook to Internet using
  - phone as modem 76
- Connect phone to Internet
  - dial-up to ISP 69
  - GPRS 68
- Connect phone to private network 70
- Contacts 22, 107
- Contacts picture (capture mode) 117, 121

Cookies (Internet Explorer) 74  
 Copy
 

- files between phone and PC 61
- media files from PC to phone 134
- pictures and videos 126
- sound file to phone 55

 Currency setting 53  
 Customize Home screen 52  
 Customize picture options 129

## D

Date setting 53  
 Default view (Web page) 72  
 Delete pictures and videos 127  
 Desktop view (Web page) 72  
 Dial-up connection 69  
 Digitally sign messages 49, 94  
 Digital Rights Management (DRM) 133  
 Digital signature
 

- verify 94

 Direct Push 46  
 Discoverable (Bluetooth) 80  
 Display time out 57  
 Download Agent 22  
 Download messages 93

## E

E-mail
 

- attachments 92
- Outlook 88
- overview 88
- POP3/IMAP4 89
- security 49, 94
- send and receive 91

Edit picture 127  
 Emergency call 36  
 Encrypt messages 49, 94  
 Enter text and numbers 25  
 Error reporting 57  
 Event notification 53  
 Exchange Server
 

- schedule synchronization 46
- synchronize 45

 Exclude e-mail address when replying to all 92  
 external screen 57

## F

Favorites (Internet Explorer) 73  
 File Explorer 62  
 Find contacts online 109  
 Font size (display) 56  
 Full-screen mode (Internet Explorer) 73

## G

Games 22  
 GIF animation 126  
 Global Address List (GAL) 109  
 GPRS 68

## H

Hide pictures on Web page 73  
 History (Internet Explorer) 74  
 Home screen 20
 

- change background 128
- customize 52
- overview 52

**I**

- IMAP4 89
- In-call alert volume 56
- Insert pause in dialing sequence 36, 37
- Insert SIM Card 18
- Install MIDlets
  - from Internet 138
  - from PC 138
  - locally 139
- Install Mini-SD Card 19
- International call 36
- Internet 68
- Internet Explorer 23
- Internet Explorer Mobile 72

**K**

- Keypad
  - lock 65
  - sound 54

**L**

- Language/locale setting 53
- Launch camera from Pictures & Videos 127
- LED indicator lights 16
- Licensed and protected media 133
- Light sensor (keypad) 57
- Lock
  - keypad 65
  - phone 65

**M**

- Make call

- from Call History 33
- from Contacts 32
- from Home Screen 31
- from Speed Dial 33

- Manage low battery 28
- Media synchronization settings 48
- Memory 60
- Message folders 95
- Messaging 23, 88
- MIDlet Manager 23, 138
- MMS

- access MMS 97
- add audio 102
- add canned text 101
- add photo/video 101
- create and send 99
- menu options 102
- MMS settings 97
- view and reply 103

- MMS video (capture mode) 117, 121

**Modem**

- Bluetooth modem 85

- MSN Messenger 104
- Multipress mode 25
- Multipress time out 56
- Mute call 35

**N**

- Number format 53
- Numeric mode 26

**O**

- One column view (Web page) 72
- Operating system version 57
- Outlook e-mail 88

Owner information 55

## P

Parts and accessories 12

Pause in dialing sequence 36, 37

Personal information 55

Phone program 29

Phone specification 57

Photo (capture mode) 117, 121

Pictures

- assign to contact 111
- assign to contacts 129
- hide or show on Web page 73
- set as Home screen background 128

Pictures & Videos 23, 125

Picture theme (capture mode) 117, 121

PIN 30, 64

Play media 136

Pocket MSN 23, 104

POP3 89

Power management 56

Profile 53

Programs 21

- ActiveSync 22, 40
- Calculator 22
- Calendar 22, 105
- Call History 22
- Camera 22, 116
- ClearVue Document 22
- ClearVue PDF 22
- ClearVue PPT 22
- ClearVue Worksheet 22
- Clear Storage 22
- Comm Manager 22

- Contacts 22, 107

- Download Agent 22

- Games 22

- Internet Explorer 23, 72

- Messaging 23, 88

- MIDlet Manager 23, 138

- Phone 29

- Pictures & Videos 23, 125

- Pocket MSN 23, 104

- SIM Tool Kit 23

- Speed Dial 23

- Tasks 23, 112

- Task Manager 23, 60

- Video Recorder 23, 116

- Voice Notes 23, 113

- Windows Media Player Mobile 23, 130

Put call on hold 34

## Q

Quick List 24

## R

Receive

- call 34

- e-mail/SMS message 91

- MMS message 103

Regional settings 53

Reply

- e-mail/SMS message 92

- MMS message 103

Reset phone 66

Restart phone 66

Review screen 120

Ring tone 30, 111, 113

Run MIDlets 139

## S

- Secure/Multipurpose Internet Mail Extension (S/MIME) 49
- Security
  - e-mail 49, 94
  - Internet 74
- Send
  - contact's details (vCard) 111
  - email/SMS message 91
  - instant message (MSN) 105
  - MMS message 99
  - pictures/videos via e-mail 128
- Settings 23
- Set up Home screen 52
- SIM Manager 23, 107
- SIM Tool Kit 37
- SMS 88, 91
- Sounds 53
- Speakerphone 35
- Speed Dial 23, 33
- Sport (capture mode) 117, 121
- Start menu 24
- Status indicators 21
- Still image capture modes 121
- Stop programs 60
- Swap/switch calls 35
- Synchronize
  - information types 44
  - music and video 48
  - Outlook information with Exchange Server 45
  - Outlook information with the computer 43
  - schedule synchronization with Exchange Server 46
  - start/stop synchronization 43

- storage card 48
- via Bluetooth 47
- via Infrared 47

Sync Setup Wizard 40

System font size 56

## T

- T9 mode 26
- Tasks 23, 112
- Task Manager 23, 60
- Temporary files (Internet Explorer) 74
- Text messages (SMS) 88, 91
- Text size (Web page) 72
- Time setting 53

## U

USB modem 74

## V

- vCard 111
- Verify digital signature 94
- Video (capture mode) 117, 121
- Video Recorder 23, 116
- View
  - photo slide show 126
  - pictures 126
- Voice Notes 23, 113
- Voice tag
  - create voice tag for phone number, e-mail address, or URL in Contacts 149
  - create voice tag for program 150
  - edit, delete, and play voice tags 150

## W

Web browser 72

Web page display options 72

Windows Media Player

- file formats 130

- menus 131

- synchronize 48

- troubleshooting 137

Windows Media Player Mobile 23

Windows Mobile software version  
57

Wireless Modem 23, 74

## Z

Zoom 122

