

# Panasonic®

## Basic Owner's Manual Digital Camera

Model No. **DMC-LF1**

LUMIX

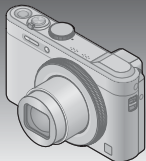

Please read these instructions carefully before using this product, and save this manual for future use.

More detailed instructions on the operation of this camera are contained in "Owner's Manual for advanced features (PDF format)" in the supplied CD-ROM. Install it on your PC to read it.



Register online at [www.panasonic.com/register](http://www.panasonic.com/register) (U.S. customers only)

For USA and Puerto Rico assistance, please call: 1-800-211-PANA(7262) or, contact us via the web at: <http://www.panasonic.com/contactinfo>

P



VQT5A15  
M0513KZ0

**Dear Customer,  
Thank you for choosing Panasonic!**

You have purchased one of the most sophisticated and reliable products on the market today. Used properly, we're sure it will bring you and your family years of enjoyment. Please take time to fill in the information below. The serial number is on the tag located on the underside of your camera. Be sure to **retain this manual** as your convenient camera information source.

Date of Purchase	Dealer Phone No.
Dealer Purchased From	Model No.
Dealer Address	Serial No.

Please note that the actual controls and components, menu items, etc. of your Digital Camera may look somewhat different from those shown in the illustrations in this Owner's Manual.

**Carefully observe copyright laws.**

- Recording of pre-recorded tapes or discs or other published or broadcast material for purposes other than your own private use may infringe copyright laws. Even for the purpose of private use, recording of certain material may be restricted.



A lithium ion battery that is recyclable powers the product you have purchased. Please call 1-800-8-BATTERY for information on how to recycle this battery.

## Information for Your Safety

The socket outlet shall be installed near the equipment and shall be easily accessible.

### ■ Product identification marking

Product	Location
Digital camera	Bottom

### **WARNING:**

To reduce the risk of fire, electric shock or product damage,

- Do not expose this unit to rain, moisture, dripping or splashing.
- Use only the recommended accessories.
- Do not remove covers.
- Do not repair this unit by yourself. Refer servicing to qualified service personnel.

### ■ About the AC adaptor (supplied)

#### **CAUTION!**

To reduce the risk of fire, electric shock or product damage,

- Do not install or place this unit in a bookcase, built-in cabinet or in another confined space. Ensure this unit is well ventilated.

#### **AC adaptor**

This AC adaptor operates on AC between 110V and 240V.

But

- In the U.S.A. and Canada, the AC adaptor must be connected to a 120V AC power supply only.
- When connecting to an AC supply outside of the U.S.A. or Canada, use a plug adaptor to suit the AC outlet configuration.

## ■ About the battery pack

### CAUTION

Battery pack (Lithium ion battery pack)

- Use the specified unit to recharge the battery pack.
- Do not use the battery pack with equipment other than the specified unit.
- Do not get dirt, sand, liquids, or other foreign matter on the terminals.
- Do not touch the plug terminals (+ and -) with metal objects.
- Do not disassemble, remodel, heat or throw into fire.

If any electrolyte should come into contact with your hands or clothes, wash it off thoroughly with water.

If any electrolyte should come into contact with your eyes, never rub the eyes. Rinse eyes thoroughly with water, and then consult a doctor.

### CAUTION

- Danger of explosion if battery is incorrectly replaced. Replace only with the type recommended by the manufacturer.
- When disposing the batteries, please contact your local authorities or dealer and ask for the correct method of disposal.

- Do not heat or expose to flame.
- Do not leave the battery(ies) in a car exposed to direct sunlight for a long period of time with doors and windows closed.

### Warning

Risk of fire, explosion and burns. Do not disassemble, heat above 60 °C (140 °F) or incinerate.



**FCC Note:**

This equipment has been tested and found to comply with the limits for a Class B digital device, pursuant to Part 15 of the FCC Rules. These limits are designed to provide reasonable protection against harmful interference in a residential installation. This equipment generates, uses, and can radiate radio frequency energy and, if not installed and used in accordance with the instructions, may cause harmful interference to radio communications. However, there is no guarantee that interference will not occur in a particular installation. If this equipment does cause harmful interference to radio or television reception, which can be determined by turning the equipment off and on, the user is encouraged to try to correct the interference by one or more of the following measures:

- Reorient or relocate the receiving antenna.
- Increase the separation between the equipment and receiver.
- Connect the equipment into an outlet on a circuit different from that to which the receiver is connected.
- Consult the dealer or an experienced radio/TV technician for help.

**FCC Caution:** To assure continued compliance, follow the attached installation instructions and use only shielded interface cables with ferrite core when connecting to computer or peripheral devices.

Any changes or modifications not expressly approved by the party responsible for compliance could void the user's authority to operate this equipment.

**Declaration of Conformity**

**Trade Name:** Panasonic

**Model No.:** DMC-LF1

Responsible Party: Panasonic Corporation of North America  
One Panasonic Way, Secaucus, NJ 07094

Support Contact: Panasonic Consumer Marketing Company of North America  
1-800-211-PANA (7262)

This device complies with Part 15 of the FCC Rules. Operation is subject to the following two conditions: (1) This device may not cause harmful interference, and (2) this device must accept any interference received, including interference that may cause undesired operation.

## ■ Cautions for Use

- Do not use any other USB connection cables except the supplied one or a genuine Panasonic USB connection cable (DMW-USBC1: optional).
- Always use a genuine Panasonic AV cable (DMW-AVC1: optional).

### **Keep this unit as far away as possible from electromagnetic equipment (such as microwave ovens, TVs, video games etc.).**

- If you use this unit on top of or near a TV, the pictures and/or sound on this unit may be disrupted by electromagnetic wave radiation.
- Do not use this unit near cell phones because doing so may result in noise adversely affecting the pictures and/or sound.
- Recorded data may be damaged, or pictures may be distorted, by strong magnetic fields created by speakers or large motors.
- Electromagnetic wave radiation generated by microprocessors may adversely affect this unit, disturbing the pictures and/or sound.
- If this unit is adversely affected by electromagnetic equipment and stops functioning properly, turn this unit off and remove the battery or disconnect AC adaptor (supplied). Then reinsert the battery or reconnect AC adaptor and turn this unit on.

### **Do not use this unit near radio transmitters or high-voltage lines.**

- If you record near radio transmitters or high-voltage lines, the recorded pictures and/or sound may be adversely affected.

### **Certification and Compliance**

See Camera for the certification and compliance mark specific to that device.

- 1 Select [Wi-Fi Setup] in the [Wi-Fi] menu**
- 2 Press ▲ ▼ to select [Approved Regulations], and press [MENU/SET]**

Contains FCC ID : VPYLBXN604

This transmitter must not be co-located or operated in conjunction with any other antenna or transmitter.

This equipment complies with FCC radiation exposure limits set forth for an uncontrolled environment and meets the FCC radio frequency (RF) Exposure Guidelines in Supplement C to OET65. This equipment has very low levels of RF energy that are deemed to comply without testing of specific absorption ratio (SAR).

## Contents

<b>Information for Your Safety ....</b>	<b>3</b>	<b>Taking pictures with the composition determined [Composition Guide] ...</b>	<b>21</b>
<b>Before use .....</b>	<b>8</b>	<b>Viewing your pictures .....</b>	<b>22</b>
<b>Standard accessories .....</b>	<b>9</b>	<b>Deleting pictures .....</b>	<b>23</b>
<b>Names and Functions of Main Parts .....</b>	<b>10</b>	<b>What you can do with the Wi-Fi function.....</b>	<b>24</b>
<b>Inserting and removing the battery or SD memory card (optional) .....</b>	<b>12</b>	<b>Reading the Owner's Manual (PDF format).....</b>	<b>26</b>
<b>Charging the battery .....</b>	<b>13</b>	<b>Supplied software.....</b>	<b>27</b>
<b>Setting the clock.....</b>	<b>14</b>	<b>Specifications .....</b>	<b>29</b>
<b>Setting the menu .....</b>	<b>15</b>	<b>Digital Camera Accessory System... </b>	<b>32</b>
<b>Taking still pictures .....</b>	<b>16</b>	<b>Digital Camera Accessory Order Form ...</b>	<b>33</b>
<b>Recording motion pictures... </b>	<b>18</b>	<b>Limited Warranty (ONLY FOR U.S.A. AND PUERTO RICO) ...</b>	<b>34</b>
<b>Using the control ring .....</b>	<b>19</b>		

## Before use

### ■ Camera handling

- Keep the camera away from excessive vibration, force, or pressure.
- The camera is not dust resistant, splash resistant, or waterproof. Avoid using the camera in places with excessive dust or sand, or where water can come into contact with the camera.







### ■ Condensation (When the lens, the LCD monitor or the viewfinder is fogged up)

- Condensation may occur when the camera is exposed to sudden changes of temperature or humidity. Avoid these conditions, which may make the lens, the LCD monitor or the viewfinder dirty, cause mold, or damage the camera.
- If condensation does occur, turn off the camera and wait about two hours before using it. Once the camera adjusts to the surrounding temperature, the fogging will clear naturally.



## Standard accessories

Check that all the accessories are supplied before using the camera. Part numbers are as of May 2013. These may be subject to change.

<input type="checkbox"/> <b>Battery pack</b> DMW-BCN10PP • Charge the battery before use. Battery pack is indicated as battery pack or battery in the text. 	<input type="checkbox"/> <b>USB connection cable</b> K1HY08YY0034 
<input type="checkbox"/> <b>AC adaptor</b> VSK0768 	<input type="checkbox"/> <b>CD-ROM</b> • Software: Use it to install the software on your PC. 
<input type="checkbox"/> <b>Hand strap</b> VFC4297 	<input type="checkbox"/> <b>CD-ROM</b> VFF1214 • Owner's Manual for advanced features 

- SD Memory Card, SDHC Memory Card and SDXC Memory Card are indicated as card in the text.
- **Cards are optional.** You can record or play back pictures on the built-in memory when you are not using a card.
- For information about optional accessories, refer to the “Digital Camera Accessory System”.
- If any accessories are lost, customers should contact Panasonic's parts department at 1-800-833-9626 for further information about obtaining replacement parts.
- Please dispose of all packaging appropriately.
- Keep small parts in a safe place out of the reach of children.
- The illustrations and screens in this manual may differ from the actual product.

## Names and Functions of Main Parts

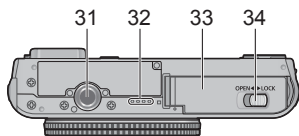
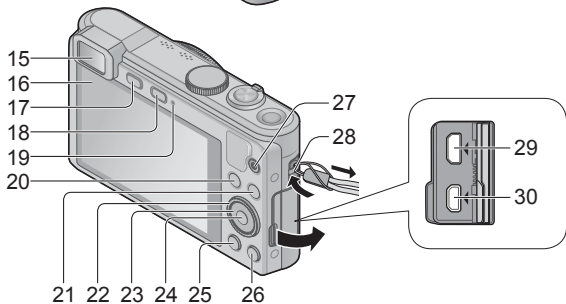
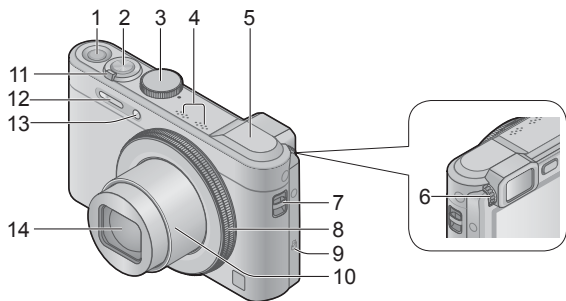

- 1 Camera [ON/OFF] button
- 2 Shutter button
- 3 Mode dial
- 4 Microphones
- 5 [Wi-Fi] antenna
- 6 Diopter adjustment dial
- 7 Strap eyelet
- 8 Control ring
- 9 NFC antenna
- 10 Lens barrel
- 11 Zoom lever
- 12 Flash
- 13 Self-timer indicator/  
AF Assist Lamp
- 14 Lens
- 15 Viewfinder
- 16 LCD monitor
- 17 [LVF] button
  - Use this to switch display between viewfinder and LCD monitor.
- 18 [Wi-Fi] button
- 19 Charging lamp/  
Wi-Fi connection lamp
- 20 [Fn] button
- 21 Playback button
- 22 Control dial
- 23 Cursor button
  - In this manual, the button that is to be used is indicated by ▲▼◀▶.
- 24 [MENU/SET] button
- 25 [DISP.] button
- 26 [Q.MENU/ ] / [ ] button
- 27 Motion picture button
- 28 Strap eyelet
  - We recommend using the supplied hand strap to avoid dropping the camera.
- 29 [HDMI] socket
- 30 [AV OUT/DIGITAL] socket
  - This socket is also used when charging the battery.
- 31 Tripod mount
  - Do not attach to a tripod with a 5.5 mm (0.22 inch) or longer screw. Doing so may damage this unit.
- 32 Speaker
- 33 Card/Battery door
- 34 Release lever

# Inserting and removing the battery or SD memory card (optional)

Make sure that the camera is turned off.

- 1 Slide the release lever (A) to the [OPEN] position and open the card/battery door**



- 2 Insert the battery and card, making sure that their orientation is correct**

- Battery: Insert the battery all the way firmly and check that it is locked by lever (B).
- Card: Insert the card all the way firmly until it clicks. Do not touch the terminals on the back of the card.

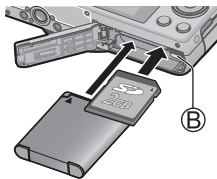

- 3 Close the door**

Slide the release lever to the [LOCK] position.

## ■ To remove

### • To remove battery:

Move lever in direction of arrow.

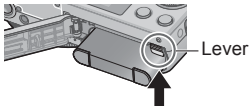

### • To remove card:

Push the card until it clicks, then pull the card out.

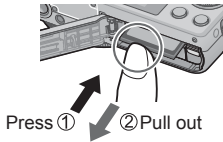

- Always use genuine Panasonic batteries (DMW-BCN10PP).
- If you use other batteries, we cannot guarantee the quality of this product.
- Keep the Memory Card out of reach of children to prevent swallowing.
- We recommend using a Panasonic card.

## Charging the battery

- The battery that can be used with this unit is DMW-BCN10PP.
- The battery is not charged when the camera is shipped. Charge the battery before use.
- Charge the battery with the AC adaptor (supplied) indoors (10 °C to 30 °C (50 °F to 86 °F)).

Make sure that the camera is turned off.

- 1 Insert the battery to this unit, and then connect this unit to the AC adaptor (supplied) (A) or a PC (B)

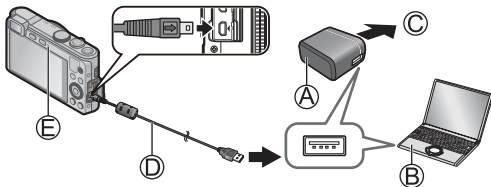

- © To the electrical outlet
- © USB connection cable (supplied)

### ■ Charging lamp (E)

**On:** Charging in progress (Red)

**Off:** Charging stops (Charging time: Approx. 160 min)

When using the AC adaptor (supplied), observe the following points as improper connections may cause malfunctions.

- Do not use any other USB connection cables except the supplied one or a genuine Panasonic USB connection cable (DMW-USBC1: optional).
- Do not use any other AC adaptors except the supplied one.
- Do not use the AC adaptor (supplied) or the USB connection cable (supplied) with other devices.

## Setting the clock

The clock is not set when the camera is shipped.  
Disconnect the unit from the AC adaptor (supplied).

- 1 Press the Camera [ON/OFF] button (A)**
- 2 Press [MENU/SET] (B)**
- 3 Press ◀▶ to select the items (year, month, day, hour, minute, display order or time display format), and press ▲▼ to set**
  - To cancel → Press [Q.MENU/↶] button.
- 4 Press [MENU/SET] to set**
- 5 Confirm the setting and press [MENU/SET]**
  - To return to the previous screen, press [Q.MENU/↶] button.



### ■ Changing time settings

Select [Clock Set] from [Rec] or [Setup] menu, perform **3** and **4**.  
Please see the next page on how to set the menu.

## Setting the menu

Refer to the following procedures to operate the menus.

**Example: Setting [AF Mode] from  to  in the [Program AE] Mode**

### 1 Press [MENU/SET] to display the menu

#### Switching to the [Rec] menu

Use cursor button to select [Rec] and press [MENU/SET]

- Items can also be selected by turning the control dial.



### 2 Press $\blacktriangle$ $\blacktriangledown$ to select [AF Mode] and then press [MENU/SET]

- Depending on the item, its setting may not appear or it may be displayed in a different way.

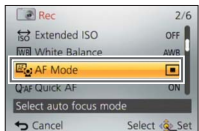

### 3 Press $\blacktriangle$ $\blacktriangledown$ to select and then press [MENU/SET] to set

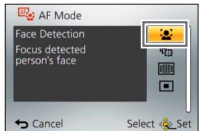

### 4 Press [Q.MENU/↶] button several times to close the menu

- In recording mode, the menu screen can also be exited by pressing the shutter button halfway.

## Taking still pictures

- 1 Press the Camera [ON/OFF] button (A)

- 2 Set to the desired recording mode

Align the mode dial correctly to the mode that you want to use.

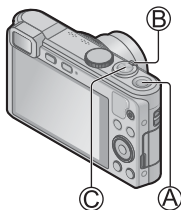
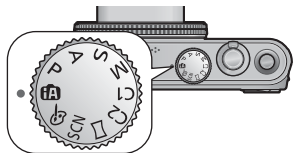

- 3 Use the zoom lever (B) to adjust the range of the picture to be captured

Capture a wider area (wide-angle)      Enlarge the subject (telephoto)



- 4 Press the shutter button (C) halfway to focus





- 5 Press the shutter button (C) fully to take the picture





## ■ Recording mode

<b>iA</b>	Take pictures with automatic settings.
<b>P</b>	Take pictures with automatic shutter speed and aperture value settings.
<b>A</b>	Determine aperture, then record pictures.
<b>S</b>	Determine shutter speed, then record pictures.
<b>M</b>	Determine aperture and shutter speed, then record pictures.
<b>C1</b> <b>C2</b>	Record pictures using pre-registered settings.
	Record panorama pictures.
<b>SCN</b>	Take pictures using Scene modes.
	Take pictures by selecting your preferred picture effect.

## ■ Holding the camera

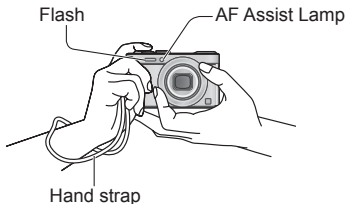

- To avoid camera shake, hold it with both hands keeping your arms close to your body while standing with your feet slightly apart.
- Do not touch the lens.
- Do not block the flash or the lamp. Do not look at it from close range.

## Recording motion pictures

You can record motion pictures with audio (stereo). Zoom can also be used during recording.

### 1 Press the motion picture button (A) to start recording

- Do not block the microphones (B) when recording motion pictures.
- Immediately release the motion picture button after pressing it.

### 2 Press the motion picture button (A) again to end recording

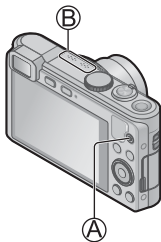

- About recording time
  - You can continuously record a motion picture in [MP4] for up to 29 minutes 59 seconds or approx. 4 GB. (Since recording in [MP4] with [FHD] creates larger files, the recording time for such motion pictures will be shorter than 29 minutes 59 seconds.)
  - If [Rec Quality] of [AVCHD] motion pictures is set to [FHD], you can continuously record a motion picture for up to 29 minutes 59 seconds.
- **If the surrounding temperature is high, or a motion picture is recorded continuously,  $\triangle$  is displayed and recording may be stopped halfway through to protect the camera.**
- You can record a motion picture to the built-in memory only in [MP4] using the [VGA] setting.

## Using the control ring

Using the control ring allows you to perform frequently used operations and settings such as Step zoom and ISO Sensitivity directly.

### 1 Turn the control ring (A)

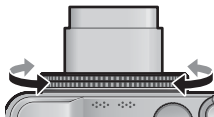

- You can also perform operations with the control dial. (Some operations may differ under certain recording conditions such as [Manual Exposure] mode.)

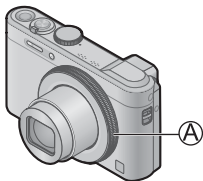

(when in [Intelligent Auto] Mode (IA))



Items that can be set by the control ring vary depending on recording modes. Following are the pre-assigned settings.

<b>IA</b> SCN	<b>Step zoom</b>
P	<b>ISO Sensitivity</b>
A	<b>Aperture adjustment</b>
S	<b>Shutter speed adjustment</b>
M	<b>Aperture adjustment</b> You can adjust the shutter speed with the control dial on the back.
 	<b>Picture effects change</b>

## Using the control ring

### Using Quick menu

Using the Quick menu, you can change camera settings with the control ring.

**1** Press [Q.MENU/↶] button (A)

**2** Press ◀▶ to select menu items



**3** Turn the control ring to change the setting

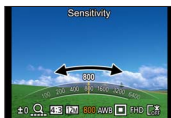
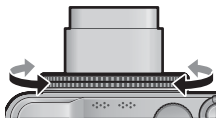

• You can also change settings with the control dial.

**4** Press [MENU/SET] (B)

## Taking pictures with the composition determined [Composition Guide]

By using the viewfinder or LCD monitor to consider the placement of your subject (the composition), you can take more impressive still pictures.

### 1 Press [Fn] button (A)

- [Fn Button Set] is set to [Composition Guide] at the time of purchase. If another function has been set, select [Composition Guide] from the [Setup] menu.



### 2 Press ▲ ▼ to select the guideline to display and press [MENU/SET]

- To turn off guideline display, select [OFF].
- If the guideline allows horizontal flipping, use ◀▶ to flip.

#### ■ Guidelines (Examples)

[Rule of Thirds Offset]

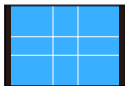

[Diagonal lines]



[Tunnel]

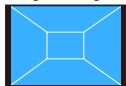

[Radiation]

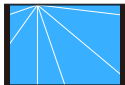

[S-shape]



## Viewing your pictures

When a card is in the camera, pictures are played back from the card, and without a card, pictures are played back from the built-in memory.

### 1 Press the Playback button (A)

- By holding down the Playback button while the camera is off, you can turn the camera on in Playback Mode.



### 2 Press ◀▶ to select a picture to be displayed

- When the buttons are held down, the pictures can be scrolled quickly forward or backward.
- Pictures can also be selected with the control dial.



## Viewing motion pictures

- 1 Select a picture with the motion picture icon, and press ▲

Motion picture icon  
(differs depending on  
the recording mode  
and picture quality  
setting)



Motion picture  
recording time

### ■ Operations during motion picture playback

▲ : Pause/play

▼ : Stop

◀ : Fast rewind (2 steps)/Single-frame rewind (while paused)

▶ : Fast forward (2 steps)/Single-frame forward (while paused)

[MENU/SET]: Capturing still pictures from motion pictures (while paused)

Control dial: Fast rewind/Fast forward (same as ◀▶)

Zoom lever: Volume adjustment

## Deleting pictures

Pictures will be deleted from the card if the card is inserted, or from the built-in memory if the card is not inserted. (Deleted pictures cannot be recovered.)

- 1 Press [ ] button (A) to delete the displayed picture
- 2 Press ◀ to select [Yes] and then press [MENU/SET] (B)



## What you can do with the Wi-Fi function

For details about Wi-Fi connections, please read “Wi-Fi connection guide”.

### ■ Using a smartphone as a camera remote control

By installing the “Panasonic Image App” on your smartphone, you can operate the camera remotely and use the smartphone to record and play back.

- By using the NFC function, you can hold your smartphone close to the camera and easily make a Wi-Fi connection without making troublesome Wi-Fi settings.



### ■ Using WEB services

Through LUMIX CLUB, you can send still pictures and motion pictures to social networking services, etc. By selecting the setting to automatically transfer still pictures and motion pictures to [Cloud Sync. Service], you can receive the transferred still pictures and motion pictures on a PC or a smartphone.

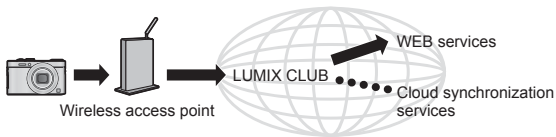



### ■ Transferring pictures automatically [Smart Transfer]

During battery charging, recorded pictures are transferred automatically to PC, AV equipment and cloud folders.



### ■ Sending pictures to Wi-Fi compatible equipment

You can select pictures on your camera and transfer them to a TV, printer, AV equipment, PC, etc.

Also, during recording, you can transfer still pictures as they are recorded (except for transferring to a printer).

#### ■ Panasonic Image App

The “Panasonic Image App” is an application provided by Panasonic. For details, refer to “Wi-Fi connection guide”.

#### ■ LUMIX CLUB

If you register this unit to the “LUMIX CLUB”, you can synchronize images between the devices you are using, or transfer these images to WEB services.

For details, refer to the “LUMIX CLUB” site.

<http://lumixclub.panasonic.net/eng/c/>

## Reading the Owner's Manual (PDF format)

More detailed instructions on the operation of this camera are contained in "Owner's Manual for advanced features (PDF format)" in the supplied CD-ROM. Install it on your PC to read it.

### ■ For Windows

- 1 Turn the PC on and insert the CD-ROM containing the Owner's Manual (supplied)**
- 2 Select the desired language and then click [Owner's Manual] to install**
- 3 Double-click the "Owner's Manual" shortcut icon on the desktop**

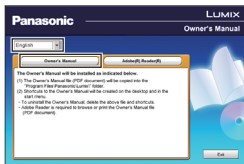

### ■ When the Owner's Manual (PDF format) will not open

You will need Adobe Acrobat Reader 5.0 or later, or Adobe Reader 7.0 or later to browse or print the Owner's Manual (PDF format).

- You can download and install a version of Adobe Reader that you can use with your OS from the following website.  
<http://get.adobe.com/reader/otherversions/>

## Supplied software

The supplied CD-ROM contains the following software.  
Install the software on your computer to use.

PHOTOfunSTUDIO 9.2 AE	Pictures can be captured to a PC, and can be viewed, organized, printed, etc. Also, still pictures can be corrected and motion pictures can be edited. • Compatible OS: Windows 8 / 7 / Vista / XP
SILKYPIX Developer Studio	This software develops and edits RAW file pictures. Edited pictures can be saved in a file format such as JPEG or TIFF that can be displayed on a PC, etc. For details on how to use the SILKYPIX Developer Studio, refer to the “Help” or the Ichikawa Soft Laboratory’s support website: <a href="http://www.isl.co.jp/SILKYPIX/english/p/support/">http://www.isl.co.jp/SILKYPIX/english/p/support/</a> • Compatible OS: Windows 8 / 7 / Vista / XP Mac OS X v10.4 / v10.5 / v10.6 / v10.7 / v10.8
LoiLoScope (30-day full-trial version)	You can edit motion pictures easily. This will only install a shortcut to the trial version download site. For details about using LoiLoScope, please download and see the manual from the following site. <a href="http://loilo.tv/product/20/">http://loilo.tv/product/20/</a> • Compatible OS: Windows 8 / 7 / Vista / XP

For details about operating environment and usage, please read “Owner’s Manual for advanced features” (PDF format) or the manuals for each software.

- PHOTOfunSTUDIO / LoiLoScope are not compatible with Mac.

### Installing supplied software

#### Preparations:

- Check your PC's specifications and operating environment for each software.
- Before inserting the CD-ROM (supplied), close all running applications.

#### ■ Windows

##### 1 Insert the CD-ROM with the supplied software

- The installation menu runs.

##### 2 Click [Recommended Installation]

- Continue the installation procedure following the instructions displayed on the screen.

#### ■ Mac (SILKYPIX Developer Studio)

##### 1 Insert the CD-ROM with the supplied software

##### 2 Double-click the recognized disc to open

##### 3 Double-click the [SILKYPIX] folder to open

##### 4 Double-click an icon in the folder

- Continue the installation procedure following the instructions displayed on the screen.

# Specifications

## Digital Camera: Information for your safety

<b>Power Source</b>	DC 5 V
<b>Power Consumption</b>	1.7 W (When recording with LCD Monitor) 1.1 W (When playing back with LCD Monitor)
<b>Camera effective pixels</b>	12,100,000 pixels
<b>Image sensor</b>	1/1.7" MOS sensor, total pixel number 12,800,000 pixels Primary color filter
<b>Lens</b>	Optical 7.1x zoom f=6.0 mm to 42.8 mm (35 mm film camera equivalent: 28 mm to 200 mm) / F2.0 (Max. Wide) to F5.9 (Max. Tele)
<b>Image Stabilizer</b>	Optical method
<b>Focus range</b>	
<b>Normal</b>	50 cm (1.6 feet) (Max. Wide) / 80 cm (2.6 feet) (Max. Tele) to ∞
<b>Macro / iA mode / Motion picture / MF</b>	3 cm (0.098 feet) (Max. Wide) / 80 cm (2.6 feet) (Max. Tele) to ∞
<b>Scene Mode</b>	The focus ranges listed above may vary depending on the selected Scene Mode.
<b>Shutter system</b>	Electronic shutter + Mechanical shutter
<b>Shutter speed</b>	250 seconds to 1/4000th of a second [Starry Sky] Mode: 15 seconds, 30 seconds, 60 seconds
<b>Minimum Illumination</b>	Approx. 6 lx (when i-Low light is used, the shutter speed is 1/30th of a second)

## Specifications

<b>Exposure (AE)</b>	Program AE (P) / Aperture-priority AE (A) / Shutter-priority AE (S) / Manual exposure (M)
<b>Metering Mode</b>	[Multi Metering] / [Center Weighted] / [Spot]
<b>LCD monitor</b>	3.0" TFT LCD (3:2) (Approx. 921,600 dots)
<b>Viewfinder</b>	Color LCD Viewfinder (Approx. 200,000 dots) (with diopter adjustment -4 to +4 diopter)
<b>Microphones</b>	Stereo
<b>Speaker</b>	Monaural
<b>Recording media</b>	Built-in Memory (Approx. 87 MB) SD Memory Card / SDHC Memory Card / SDXC Memory Card
<b>Recording file format</b>	
<b>Still picture</b>	RAW / JPEG (based on Design rule for Camera File system, based on Exif 2.3 standard / DPOF corresponding) / MPO
<b>Motion pictures</b>	AVCHD / MP4
<b>Audio compression format</b>	AVCHD: Dolby® Digital (2 ch) MP4: AAC (2 ch)
<b>Interface</b>	
<b>Digital</b>	USB 2.0 (High Speed)
<b>Analog video</b>	NTSC Composite
<b>Audio</b>	Audio line output (Monaural)
<b>Terminal</b>	HDMI: MicroHDMI TypeD AV OUT/DIGITAL: Dedicated jack (8 pin)
<b>Dimensions</b>	Approx. 102.5 mm (W) x 62.1 mm (H) x 27.9 mm (D) [4.0" (W) x 2.4" (H) x 1.1" (D)] (excluding the projection part)

<b>Mass (Weight)</b>	With card and battery: Approx. 192 g (0.42 lb) Excluding card and battery: Approx. 170 g (0.37 lb)
<b>Operating temperature</b>	0 °C to 40 °C (32 °F to 104 °F)
<b>Operating humidity</b>	10%RH to 80%RH
<b>Language select</b>	[ENGLISH] / [ESPAÑOL]

### Wi-Fi

<b>Compliance standard</b>	IEEE 802.11b/g/n (standard wireless LAN protocol)
<b>Frequency range used (central frequency)</b>	2412 MHz to 2462 MHz (1ch to 11ch)
<b>Encryption method</b>	Wi-Fi compliant WPA™ / WPA2™
<b>Access method</b>	Infrastructure mode

### NFC

<b>Compliance standard</b>	ISO / IEC 18092 NFC-F (Passive Mode)
----------------------------	--------------------------------------

### AC adaptor

**(Panasonic VSK0768):** Information for your safety

<b>Input</b>	~ 110 V to 240 V, 50/60 Hz, 0.2 A
<b>Output</b>	=== 5 V, 800 mA

### Battery pack (lithium-ion)

**(Panasonic DMW-BCN10PP):** Information for your safety

<b>Voltage / capacity</b>	3.7 V / 950 mAh
---------------------------	-----------------

Specifications are subject to change without notice.

## Digital Camera Accessory System

Description	Accessory#
Battery pack	DMW-BCN10
USB connection cable	DMW-USBC1
AV cable	DMW-AVC1

- Product numbers are correct as of May 2013. These may be subject to change.
- Accessories and/or model numbers may vary between countries. Consult your local dealer.



# Digital Camera Accessory Order Form

Please photocopy this form when placing an order.

1. Digital Camera Model # \_\_\_\_\_

2. Items Ordered

Accessory #	Description	Price Each	Quantity	Total Price
Shipping & Handling				\$6.95
Subtotal				
Your State & Local Sales Tax				
Total				

3. Method of payment (check one)

- American Express  
 VISA  
 MasterCard  
 Discover

Credit Card # \_\_\_\_\_

Expiration Date \_\_\_\_\_

Customer Signature \_\_\_\_\_

(Please do not send cash)

4. Shipping information (UPS delivery requires complete street address)

Ship To:

Mr.

Mrs.

Ms.

First \_\_\_\_\_ Last \_\_\_\_\_

Phone#: \_\_\_\_\_

Street Address \_\_\_\_\_

Day ( ) \_\_\_\_\_

City \_\_\_\_\_ State \_\_\_\_\_ Zip \_\_\_\_\_

Night ( ) \_\_\_\_\_

TO OBTAIN ANY OF OUR DIGITAL CAMERA ACCESSORIES YOU CAN DO ANY OF THE FOLLOWING:

VISIT YOUR LOCAL PANASONIC DEALER

OR

CALL PANASONIC'S ACCESSORY ORDER LINE AT 1-800-332-5368

[6 AM-6 PM M-F, PACIFIC TIME]

OR

MAIL THIS ORDER TO: PANASONIC NATIONAL PARTS CENTER

20421 84th Ave S., Kent, WA 98032

## Limited Warranty (ONLY FOR U.S.A. AND PUERTO RICO)

Panasonic Consumer Marketing Company of North America,  
Division of Panasonic Corporation of North America  
One Panasonic Way, Secaucus, New Jersey 07094

### Panasonic Products Limited Warranty

#### Limited Warranty Coverage (For USA and Puerto Rico Only)

If your product does not work properly because of a defect in materials or workmanship, Panasonic Consumer Marketing Company of North America (referred to as “the warrantor”) will, for the length of the period indicated on the chart below, which starts with the date of original purchase (“warranty period”), at its option either (a) repair your product with new or refurbished parts, (b) replace it with a new or a refurbished equivalent value product, or (c) refund your purchase price. The decision to repair, replace or refund will be made by the warrantor.

Product or Part Name	Parts	Labor
Digital Camera	1 Year	1 Year
All included Accessories (Except Non-Rechargeable Batteries)	90 Days	Not Applicable
Only Non-Rechargeable Batteries	10 Days	Not Applicable

During the “Labor” warranty period there will be no charge for labor. During the “Parts” warranty period, there will be no charge for parts. This Limited Warranty excludes both parts and labor for non-rechargeable batteries, antennas, and cosmetic parts (cabinet). This warranty only applies to products purchased and serviced in the United States or Puerto Rico. This warranty is extended only to the original purchaser of a new product which was not sold “as is”.

## Mail-In Service

For assistance in the U.S.A. and Puerto Rico in obtaining repairs, please ship the product prepaid to:

**Panasonic Exchange Center**  
**4900 George McVay Drive**  
**Suite B**  
**McAllen, TX 78503**  
**[panacare@us.panasonic.com](mailto:panacare@us.panasonic.com)**

## Online Repair Request

To submit a new repair request and for quick repair status visit our Web Site at [www.panasonic.com/repair](http://www.panasonic.com/repair).

When shipping the unit, carefully pack, include all supplied accessories listed in the Owner's Manual, and send it prepaid, adequately insured and packed well in a carton box. When shipping Lithium Ion batteries please visit our Web Site at [www.panasonic.com/BatteryHandling](http://www.panasonic.com/BatteryHandling) as Panasonic is committed to providing the most up to date information. Include a letter detailing the complaint, a return address and provide a daytime phone number where you can be reached. A valid registered receipt is required under the Limited Warranty.

**IF REPAIR IS NEEDED DURING THE WARRANTY PERIOD, THE PURCHASER WILL BE REQUIRED TO FURNISH A SALES RECEIPT/PROOF OF PURCHASE INDICATING DATE OF PURCHASE, AMOUNT PAID AND PLACE OF PURCHASE. CUSTOMER WILL BE CHARGED FOR THE REPAIR OF ANY UNIT RECEIVED WITHOUT SUCH PROOF OF PURCHASE.**

## **Limited Warranty Limits And Exclusions**

This warranty ONLY COVERS failures due to defects in materials or workmanship, and DOES NOT COVER normal wear and tear or cosmetic damage. The warranty ALSO DOES NOT COVER damages which occurred in shipment, or failures which are caused by products not supplied by the warrantor, or failures which result from accidents, misuse, abuse, neglect, mishandling, misapplication, alteration, faulty installation, set-up adjustments, misadjustment of consumer controls, improper maintenance, power line surge, lightning damage, modification, introduction of sand, humidity or liquids, commercial use such as hotel, office, restaurant, or other business or rental use of the product, or service by anyone other than a Factory Service Center or other Authorized Servicer, or damage that is attributable to acts of God.

**THERE ARE NO EXPRESS WARRANTIES EXCEPT AS LISTED UNDER “LIMITED WARRANTY COVERAGE”.**

**THE WARRANTOR IS NOT LIABLE FOR INCIDENTAL OR CONSEQUENTIAL DAMAGES RESULTING FROM THE USE OF THIS PRODUCT, OR ARISING OUT OF ANY BREACH OF THIS WARRANTY.**

(As examples, this excludes damages for lost time, travel to and from the servicer, loss of or damage to media or images, data or other memory or recorded content. The items listed are not exclusive, but for illustration only.)

**ALL EXPRESS AND IMPLIED WARRANTIES, INCLUDING THE WARRANTY OF MERCHANTABILITY, ARE LIMITED TO THE PERIOD OF THE LIMITED WARRANTY.**

Some states do not allow the exclusion or limitation of incidental or consequential damages, or limitations on how long an implied warranty lasts, so the exclusions may not apply to you.

This warranty gives you specific legal rights and you may also have other rights which vary from state to state. If a problem with this product develops during or after the warranty period, you may contact your dealer or Service Center. If the problem is not handled to your satisfaction, then write to the warrantor's Consumer Affairs Department at the addresses listed for the warrantor.

**PARTS AND SERVICE, WHICH ARE NOT COVERED BY THIS LIMITED WARRANTY, ARE YOUR RESPONSIBILITY.**

## Customer Services Directory (United States and Puerto Rico)

Obtain Product Information and Operating Assistance; locate your nearest Dealer or Service Center; purchase Parts and Accessories; or make Customer Service and Literature requests by visiting our Web Site at:

<http://www.panasonic.com/help>

or, contact us via the web at:

<http://www.panasonic.com/contactinfo>

You may also contact us directly at:

1-800-211-PANA (7262)

Monday-Friday 9am-9pm, Saturday-Sunday 10am-7pm EST

**For hearing or speech impaired TTY users, TTY: 1-877-833-8855**

## Accessory Purchases (United States and Puerto Rico)

Purchase Parts, Accessories and Instruction Books online for all Panasonic Products by visiting our Web Site at:

<http://www.pstc.panasonic.com>

Or, send your request by E-mail to:

[npcparts@us.panasonic.com](mailto:npcparts@us.panasonic.com)

You may also contact us directly at:

1-800-332-5368 (Phone) 1-800-237-9080 (Fax Only)

(Monday-Friday 9am-9pm EST)

Panasonic National Parts Center

20421 84th Ave S., Kent, WA 98032

(We accept Visa, MasterCard, Discover Card, American Express)

**For hearing or speech impaired TTY users, TTY: 1-866-605-1277**

As of October 2012

- SDXC Logo is a trademark of SD-3C, LLC.
- HDMI, the HDMI Logo, and High-Definition Multimedia Interface are trademarks or registered trademarks of HDMI Licensing LLC in the United States and other countries.
- HDAVI Control™ is a trademark of Panasonic Corporation.
- “AVCHD” and the “AVCHD” logo are trademarks of Panasonic Corporation and Sony Corporation.
- Manufactured under license from Dolby Laboratories. Dolby and the double-D symbol are trademarks of Dolby Laboratories.
- Windows and Windows Vista are either registered trademarks or trademarks of Microsoft Corporation in the United States and/or other countries.
- Mac and Mac OS are trademarks of Apple Inc., registered in the U.S. and other countries.
- QuickTime and the QuickTime logo are trademarks or registered trademarks of Apple Inc., used under license therefrom.
- App Store is a service mark of Apple Inc.
- The Wi-Fi CERTIFIED Logo is a certification mark of the Wi-Fi Alliance.
- The Wi-Fi Protected Setup Mark is a mark of the Wi-Fi Alliance.
- “Wi-Fi”, “Wi-Fi Protected Setup”, “Wi-Fi Direct”, “WPA” and “WPA2” are marks or registered marks of the Wi-Fi Alliance.
- DLNA, the DLNA Logo and DLNA CERTIFIED are trademarks, service marks, or certification marks of the Digital Living Network Alliance.
- This product uses “DynaFont” from DynaComware Corporation. DynaFont is a registered trademark of DynaComware Taiwan Inc.
- Other names, company names, and product names mentioned in these instructions are trademarks or registered trademarks of the companies concerned.



-If you see this symbol-



**Information on Disposal in other Countries outside the European Union**

This symbol is only valid in the European Union. If you wish to discard this product, please contact your local authorities or dealer and ask for the correct method of disposal.

**Panasonic Consumer Marketing Company of North America,  
Division of Panasonic Corporation of North America**

One Panasonic Way, Secaucus, NJ 07094

© Panasonic Corporation 2013

Printed in Japan