

# **OLYMPUS<sup>®</sup>**

DIGITAL CAMERA

## ***FE-5020/X-935***

## ***FE-4010/X-930***

### **Instruction Manual**

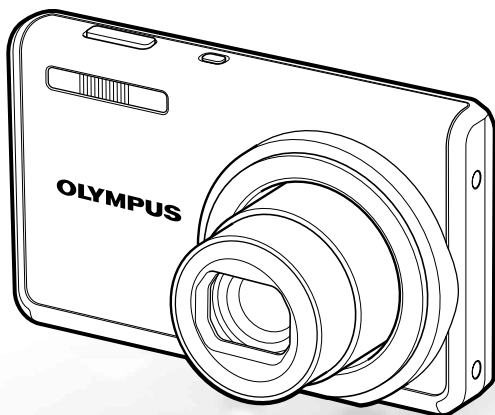

- Thank you for purchasing an Olympus digital camera. Before you start to use your new camera, please read these instructions carefully to enjoy optimum performance and a longer service life. Keep this manual in a safe place for future reference.
- We recommend that you take test shots to get accustomed to your camera before taking important photographs.
- In the interest of continually improving our products, Olympus reserves the right to update or modify information contained in this manual.
- The screen and camera illustrations shown in this manual were produced during the development stages and may differ from the actual product. Unless otherwise specified, the explanation about these illustrations is provided for FE-5020/X-935.

# Step 1

## Checking the contents of the box



Digital camera



Strap



USB cable



LI-42B Lithium Ion Battery



AV cable



LI-41C Battery Charger



microSD Attachment

Other accessories not shown: Instruction Manual (this manual), OLYMPUS Master 2, warranty card.  
Contents may vary depending on purchase location.

# Step 2

## Preparing the Camera

"Preparing the Camera" (p. 10)

# Step 3

## Shooting and Playing Back Images

"Shooting, Playback, and Erasing" (p. 14)

# Step 4

## How to Use the Camera

"Three Types of Setting Operations" (p. 3)

# Step 5

## Printing

"Direct printing (PictBridge)" (p. 35)  
"Print Reservations (DPOF)" (p. 38)

## Contents

➤ Names of Parts .....	6	➤ Menus for Playback, Editing, and Printing Functions .....	28
➤ Preparing the Camera .....	10	➤ Menus for Other Camera Settings .....	31
➤ Shooting, Playback, and Erasing .....	14	➤ Printing .....	35
➤ Using Shooting Modes.....	17	➤ Using OLYMPUS Master 2.....	40
➤ Using Shooting Functions.....	19	➤ Usage Tips .....	42
➤ Using Playback Features .....	22	➤ Appendix .....	46
➤ Menus for Shooting Functions... ..	23	➤ Index .....	61

## Three Types of Setting Operations

### Using the Menu

Various camera settings can be accessed through the menus, including functions used during shooting and playback and the date/time and screen display.

- There may be menus that are unavailable depending on other related settings or the **SCN** mode (p. 17).

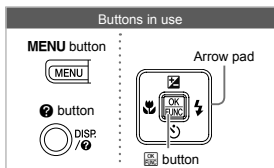

#### 1 Press the **MENU** button.

- This example describes how to use the menus to set the [POWER SAVE].



Shooting mode top menu

#### 2 Use $\leftarrow$ $\rightarrow$ $\uparrow$ $\downarrow$ to select the desired menu, and press the **DISP** button.

- Pressing and holding the **DISP** button displays an explanation (menu guide) of the selected option.

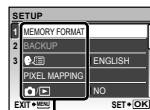

Submenu 1

#### 3 Use $\leftarrow$ $\rightarrow$ $\uparrow$ $\downarrow$ to select the desired Submenu 1, and press the **DISP** button.

Page tab

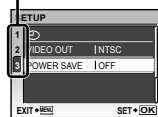

Submenu 2

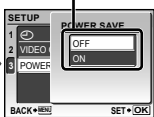

- To quickly move to the desired submenu, press **DISP** to highlight the page tab, and then use  $\leftarrow$   $\rightarrow$   $\uparrow$   $\downarrow$  to move the page. Press **DISP** to return to the submenu.

- Some menus include submenus that appear by pressing the **DISP** button.

#### 4 Use $\leftarrow$ $\rightarrow$ $\uparrow$ $\downarrow$ to select Submenu 2, and press the **DISP** button.

- Once a setting is selected, the display returns to the previous screen.

- There may be additional operations. "Menu Settings" (p. 23 to 34)

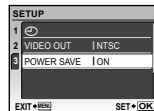

#### 5 Press the **MENU** button to complete the setting.

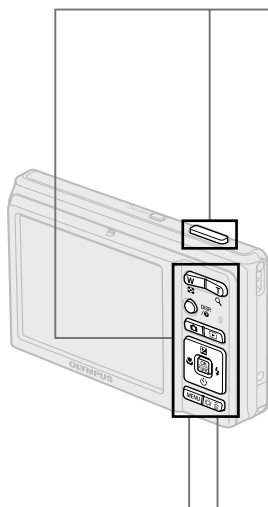

## Using the Direct Buttons

Frequently used shooting functions can be accessed using the direct buttons.





-  Shutter button (p. 14)

---

-   button (shooting/switching shooting modes) (p. 17, 18)









---

-   button (playback) (p. 15)



---

-  Zoom buttons (p. 19)



---

-   button (exposure compensation) (p. 20)
-   button (macro) (p. 20)
-   button (flash) (p. 19)
-   button (self-timer) (p. 21)

---

-   button (changing information display/ menu guide) (p. 21, 22/p. 17)

---

-   button (backlight boost/erase) (p. 21/p. 16, 30)

## Using the FUNC Menu (p. 21)

Frequently used shooting menu functions can be set with less steps using the FUNC menu.

-  button (p. 21)

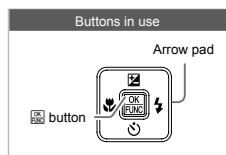

# Menu Index

## Menus for Shooting Functions

In shooting mode, settings can be adjusted.

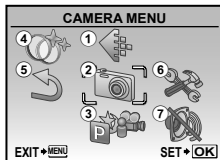
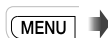

Shooting mode top menu

①  IMAGE QUALITY ..... p. 23	<b>i</b> AUTO ..... p. 17	SAVE SETTINGS ..... p. 32
②  CAMERA MENU	..... p. 18	PW ON SETUP ..... p. 32
WB ..... p. 24	<b>SCN</b> ..... p. 17	MENU COLOR ..... p. 32
ISO ..... p. 24	MOVIE ..... p. 18	SOUND SETTINGS ..... p. 33
FINE ZOOM ..... p. 25	④  MAGIC FILTER ..... p. 27	(Monitor) ..... p. 33
DIS MOVIE MODE ..... p. 25	⑤  RESET ..... p. 27	(Date/time) ..... p. 33
(Still images/ movies) ..... p. 25	⑥  SETUP	VIDEO OUT ..... p. 34
PANORAMA ..... p. 26	MEMORY FORMAT/ FORMAT ..... p. 31	POWER SAVE ..... p. 34
AF MODE ..... p. 26	BACKUP ..... p. 31	⑦  SILENT MODE ..... p. 34
③  SWITCH SHOOTING MODES	(Language) ..... p. 31	
<b>P</b> ..... p. 14	PIXEL MAPPING ..... p. 31	
	..... p. 31	

## Menus for Playback, Editing, and Printing Functions

In playback mode, settings can be adjusted.

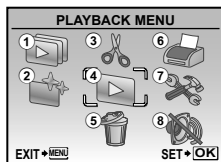
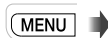

Playback mode top menu

①  SLIDESHOW ..... p. 28	④  PLAYBACK MENU	⑥  PRINT ORDER ..... p. 30
②  PERFECT FIX ..... p. 28	(Protect) ..... p. 29	⑦  SETUP
③  EDIT	(Rotate) ..... p. 29	Same as "Menu for Shooting Functions"
(Resize) ..... p. 28	(Add sound to still images) ..... p. 29	⑧  SILENT MODE ..... p. 34
(Crop) ..... p. 28	⑤  ERASE ..... p. 30	
INDEX ..... p. 29		



# Names of Parts

## Camera unit

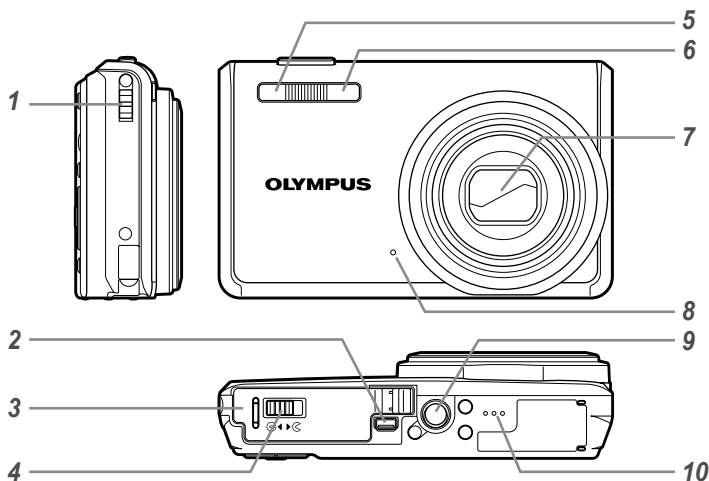

### FE-4010/X-930

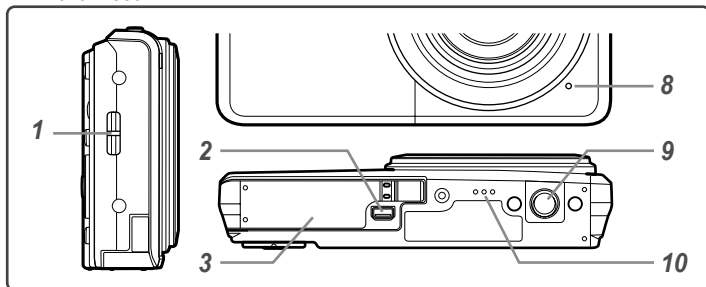

- |          |   |           |                            |
|----------|---|-----------|----------------------------|
| <b>1</b> | Strap eyelet..... p. 10                                   | <b>5</b>  | Self-timer lamp..... p. 21 |
| <b>2</b> | Multi-connector ..... p. 34, 35, 40                       | <b>6</b>  | Flash..... p. 19           |
| <b>3</b> | Battery/card<br>compartment cover..... p. 11              | <b>7</b>  | Lens..... p. 46, 59        |
| <b>4</b> | Battery/card<br>compartment lock <sup>1</sup> ..... p. 11 | <b>8</b>  | Microphone..... p. 25, 29  |
|          |   | <b>9</b>  | Tripod socket              |
|          |   | <b>10</b> | Speaker                    |

<sup>1</sup> Available in the FE-5020/X-935 only.

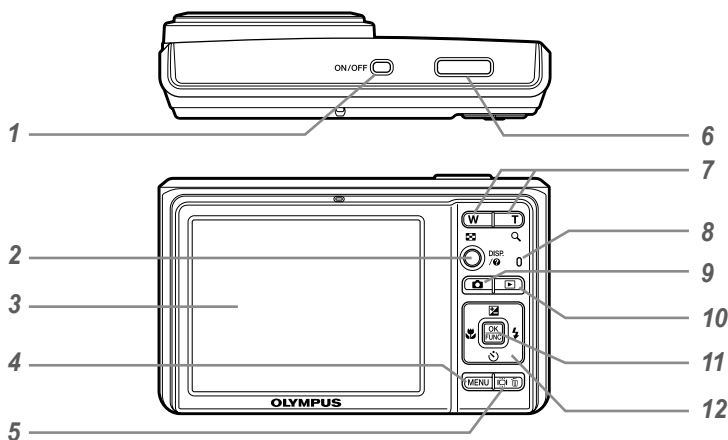

- |  |   |
|--|---|
| <p>1 ON/OFF button ..... p. 13</p> <p>2 DISP./ button<br/>(changing information display/<br/>menu guide)..... p. 21, 22/p. 17</p> <p>3 Monitor..... p. 14, 42</p> <p>4 MENU button..... p. 3</p> <p>5 / button (backlight boost/<br/>erase)..... p. 21/p. 16, 30</p> <p>6 Shutter button ..... p. 14</p> <p>7 Zoom buttons..... p. 19</p> <p>8 Card access lamp..... p. 47</p> | <p>9  button (shooting/<br/>switching shooting modes) ...p. 17, 18</p> <p>10  button (playback)..... p. 15</p> <p>11  button (OK/FUNC)..... p. 3, 21</p> <p>12 Arrow pad ..... p. 3, 12</p> <p> button (exposure compensation)<br/>..... p. 20</p> <p> button (macro) ..... p. 20</p> <p> button (self-timer) ..... p. 21</p> <p> button (flash)..... p. 19</p> |
|--|---|

Shooting mode display

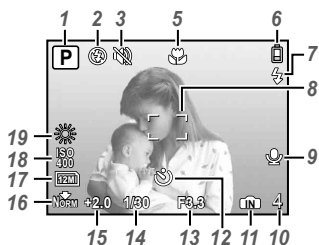

Still image

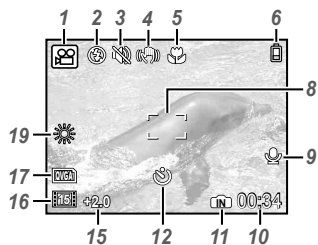

Movie

- |  |  |
|--|--|
| <p><b>1</b> Shooting mode..... p. 14</p> <p><b>2</b> Flash mode..... p. 19</p> <p><b>3</b> Silent mode..... p. 34</p> <p><b>4</b> Digital image stabilization ..... p. 25</p> <p><b>5</b> Macro/super macro..... p. 20</p> <p><b>6</b> Battery check..... p. 10</p> <p><b>7</b> Flash standby/camera shake<br/>warning/flash charge..... p. 19, 42</p> <p><b>8</b> AF target mark..... p. 14</p> <p><b>9</b> Recording with sound..... p. 25</p> | <p><b>10</b> Number of storable still pictures/<br/>remaining recording time ... p. 14/p. 18</p> <p><b>11</b> Current memory..... p. 47</p> <p><b>12</b> Self-timer ..... p. 21</p> <p><b>13</b> Aperture value ..... p. 14</p> <p><b>14</b> Shutter speed ..... p. 14</p> <p><b>15</b> Exposure compensation ..... p. 20</p> <p><b>16</b> Compression/frame rate ..... p. 23</p> <p><b>17</b> Image size ..... p. 23</p> <p><b>18</b> ISO..... p. 24</p> <p><b>19</b> White balance ..... p. 24</p> |
|--|--|



## Playback mode display

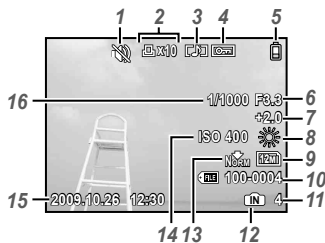

Still image

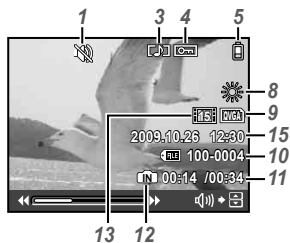

Movie

- |  |   |
|--|---|
| <p><b>1</b> Silent mode..... p. 34</p> <p><b>2</b> Print reservation/<br/>number of prints..... p. 38/p. 37</p> <p><b>3</b> Adding sound..... p. 29</p> <p><b>4</b> Protect ..... p. 29</p> <p><b>5</b> Battery check..... p. 10</p> <p><b>6</b> Aperture value ..... p. 14</p> <p><b>7</b> Exposure compensation ..... p. 20</p> <p><b>8</b> White balance ..... p. 24</p> <p><b>9</b> Image size ..... p. 23</p> | <p><b>10</b> File number..... -</p> <p><b>11</b> Frame number/<br/>Elapsed time/total recording time<br/>..... p. 15/p. 16</p> <p><b>12</b> Current memory..... p. 47</p> <p><b>13</b> Compression/frame rate ..... p. 23</p> <p><b>14</b> ISO..... p. 24</p> <p><b>15</b> Date and time ..... p. 13</p> <p><b>16</b> Shutter speed ..... p. 14</p> |
|--|---|

# Preparing the Camera

## Attaching the camera strap

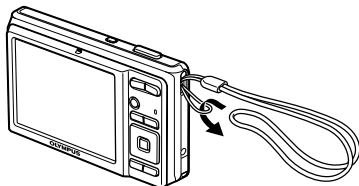

- ⚠ Pull the strap tight so that it does not come loose.

## Charging the battery

- ⚠ The battery charger included (AC cable or plug-in type) differs depending on the region where you purchased the camera. If you received a plug-in type battery charger, plug it directly into an AC outlet.

### Example: AC cable type battery charger

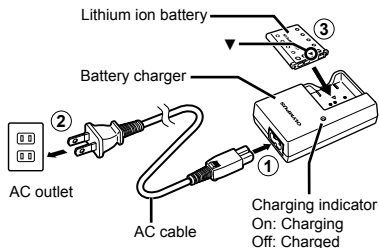

- ⚠ Battery comes partially charged. Before use, be sure to charge the battery until the charging indicator goes off (up to 2 hours).
- ⚠ If the charging indicator does not light or it blinks, the battery may not be inserted correctly or the battery or the charger may be broken.
- ⚠ For details on the battery and the charger, see "Battery and charger" (p. 46).

### When to charge the batteries

Charge the battery when the error message shown below appears.

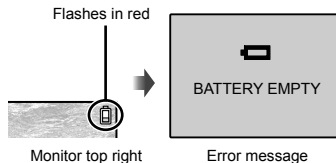

## Loading the battery and the xD-Picture Card™ (sold separately) into the camera

- Do not insert anything other than an xD-Picture Card or the microSD Attachment into the camera.

1

FE-5020/X-935

FE-4010/X-930

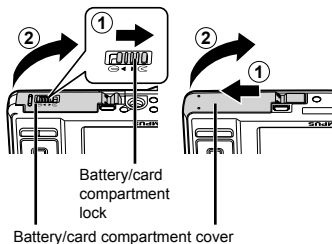

2

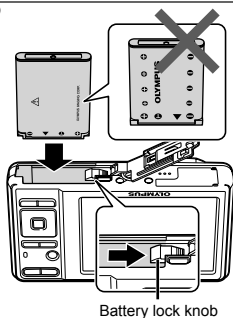

- Insert the battery by putting in the ▼ marked side first, with the ⊕ marks toward the battery lock knob. Damage to the battery exterior (scratches, etc.) may produce heat or an explosion.
- Insert the battery while sliding the battery lock knob in the direction of the arrow.
- Slide the battery lock knob in the direction of the arrow to unlock, and then remove the battery.
- Turn off the camera before opening the battery/card compartment cover.
- When using the camera, be sure to close the battery/card compartment cover.

3

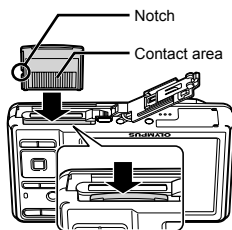

- Insert the card straight until it clicks into place.
- Do not touch the contact area directly.

4

FE-5020/X-935

FE-4010/X-930

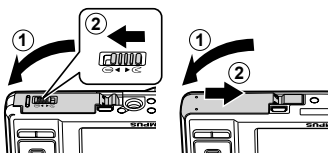

- This camera allows the user to take pictures using the internal memory even when no xD-Picture Card (sold separately) is inserted. "Using an xD-Picture Card" (p. 47)
- "Number of storable pictures (still pictures)/ Continuous recording length (movies) in the internal memory and xD-Picture Card" (p. 48)

### To remove the xD-Picture Card

1

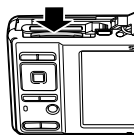

2

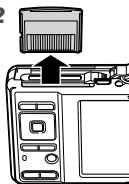

- Press the card in until it clicks and comes out slightly, then grab the card and pull it out.

## Using the microSD card/ microSDHC card (sold separately)

A microSD card or microSDHC card (hereafter both will be referred to as microSD card) is also compatible with this camera using the microSD Attachment.

! "Using the microSD Attachment" (p. 49)

### 1 Insert the microSD card into the microSD Attachment.

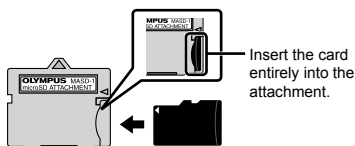

### 2 Insert the microSD Attachment into the camera.

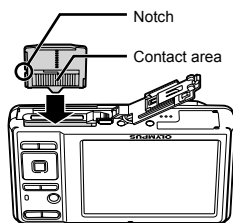

### To remove the microSD card

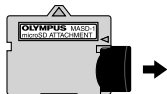



Pull the microSD card straight out.

! Do not touch the contact area of the  
microSD Attachment and/or microSD card.

## Arrow pad and operation guide

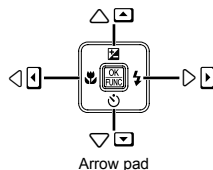
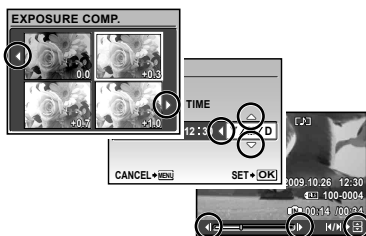
The symbols  displayed on various setting and movie playback screens indicate that the arrow pad be used.



Operation guides displayed at the bottom of the screen indicate that the **MENU** button,  button, zoom buttons, or  button be used.

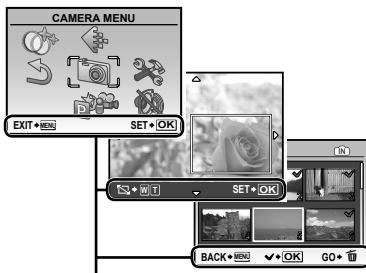

Operation guide

## Setting the date and time

The date and time set here are saved to image file names, date prints, and other data.

### 1 Press the ON/OFF button to turn on the camera.

- The date and time setting screen is displayed when the date and time are not set.

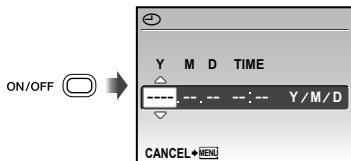

Date and time setting screen

### 2 Use to select the year for [Y].

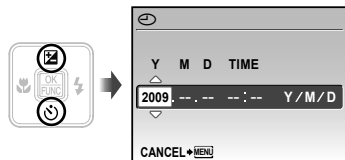

### 3 Press to save the setting for [Y].

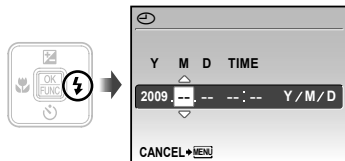

### 4 As in Steps 2 and 3, use and the button to set [M] (month), [D] (day), [TIME] (hours and minutes), and [Y/M/D] (date order).

- ! For a more accurate setting, press the button when the time signal hits 00 seconds.
- ! To change the date and time, adjust the setting from the menu. (Date/time) (p. 33)

## Changing the display language

The language for the menu and error messages displayed on the monitor is adjustable.

### 1 Press the MENU button, and press to select [SETUP] (SETUP).

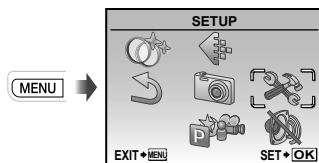

### 2 Press the button.

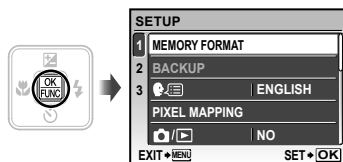

### 3 Use to select [ENGLISH] and press the button.

### 4 Use to select your language and press the button.

### 5 Press the MENU button.

# Shooting, Playback, and Erasing

## Shooting with the optimum aperture value and shutter speed (P mode)

In this mode, automatic shooting settings are activated while also allowing changes to a wide range of other shooting menu functions, such as exposure compensation, white balance, etc. as needed.

### 1 Press the ON/OFF button to turn on the camera.

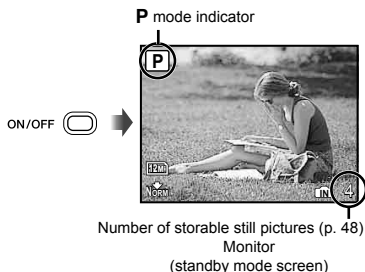

- ! If P mode is not displayed, press the  button several times to select it.

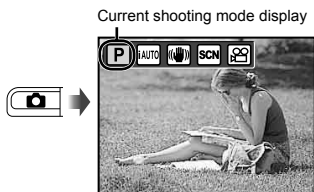

- ! Press the ON/OFF button again to turn off the camera.

### 2 Hold the camera and compose the shot.

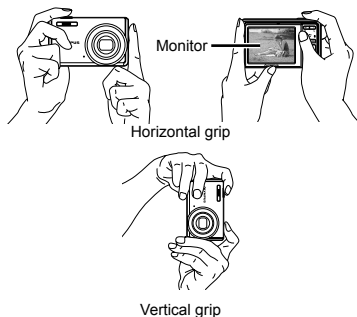

- ! When holding the camera, take care not to cover the flash with your fingers, etc.

### 3 Press the shutter button halfway down to focus on the subject.

- When the camera focuses on the subject, the exposure is locked (shutter speed and aperture value are displayed), and the AF target mark changes to green.
- The camera was unable to focus if the AF target mark flashes red. Try focusing again.

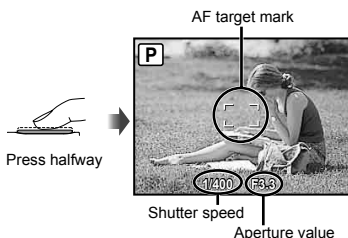

- ! "Focusing" (p. 44)

- 4** To take the picture, gently press the shutter button all the way down while being careful not to shake the camera.



Image review screen

### To view images during shooting

Pressing the button enables playback of images. To return to shooting, either press the button or press the shutter button halfway down.

### To shoot movies

"Shooting movies ( mode)" (p. 18)

## Viewing images

- 1** Press the button.



Number of frames  
Playback image

- 2** Use to select an image.

Displays 10 frames before the current image

Displays next image

Displays previous image

Displays 10 frames after the current image



- The display size of the images can be changed. "Index view and close-up view" (p. 22)

### To play back movies

Select a movie, and press the button.



Movie

### Operations during movie playback

**Volume:** During playback, press  $\blacktriangleleft/\blacktriangleright$ .

**Fast-forward:** Press and hold down  $\blacktriangleright$ .

**Rewind:** Press and hold down  $\blacktriangleleft$ .

**Pause:** Press the  $\text{II}$  button.

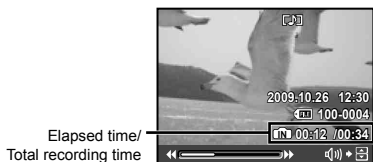

During playback

### First (last) frame/frame advance:

During pause, press  $\blacktriangleleft$  to display the first frame, and press  $\blacktriangleright$  to display the last frame.

Press and hold down  $\blacktriangleright$  to play a movie, and press and hold down  $\blacktriangleleft$  to play a movie in reverse.

Press the  $\text{II}$  button to resume playback.



During pause

### To stop movie playback

Press the **MENU** button.

## Erasing images during playback (Single image erase)

- 1 Press the  $\text{II}$  button when the image to be erased is displayed.

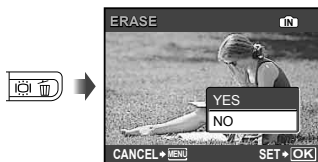

- 2 Press  $\blacktriangleleft$  to select [YES], and press the  $\text{II}$  button.

! [ERASE] (p. 30)





- ⚠ In some cases, the camera may not select the desired shooting mode.
- ⚠ When the camera cannot identify which is the optimal mode, **P** mode will be selected.

### To focus on a moving subject continuously (AF Tracking)

Press **[AF-ON]** to enter the AF tracking standby condition. For details on procedure to start tracking, see "To focus on a moving subject continuously (AF Tracking)" (p. 26).

## Using the digital image stabilization mode (iAS mode)

This mode enables the user to reduce blur that is caused by camera shake and subject movement.

- 1 Press the **[CAMERA]** button a few times to set **(iAS)**.

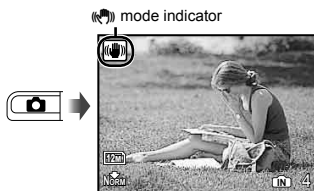

- ⚠ By switching to any of other shooting modes, most function settings in **(iAS)** mode will change to the default settings of the newly selected mode.

## Shooting movies (MOV mode)

- 1 Press the **[CAMERA]** button a few times to set **(MOV)**.

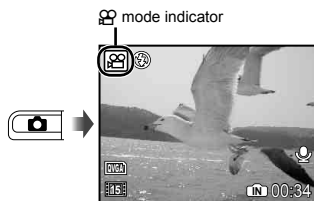

- 2 Press the shutter button halfway to focus on the subject, and gently press the button all the way down to start recording.

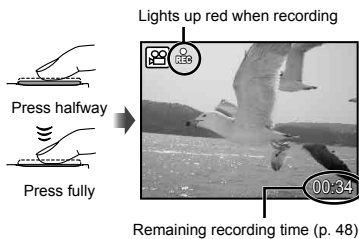

- 3 Gently press the shutter button all the way down to stop recording.

- ⚠ Sound will also be recorded.
- ⚠ During sound recording, only the digital zoom can be used. To record a movie with optical zoom, set **[ZOOM]** (movies) (p. 25) to [OFF].

# Using Shooting Functions

## Using the zoom

Pressing the zoom buttons adjusts the shooting range.

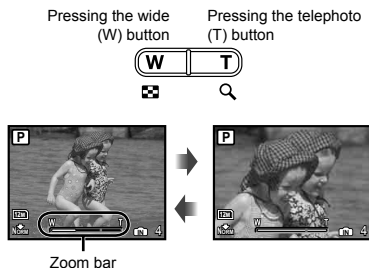

- ! Optical zoom: 5x (FE-5020/X-935)  
4x (FE-4010/X-930)
- Digital zoom: 4x
- ! Use of (M) mode (p. 18) is recommended when shooting with the telephoto zoom.

### To take larger images without reducing image quality

[FINE ZOOM] (p. 25)

- ! The zoom bar appearance identifies the status of the fine zoom/digital zoom.

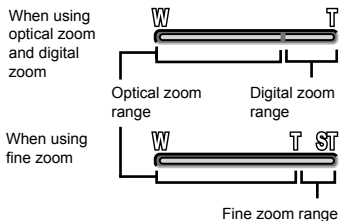

## Using the flash

The flash functions can be selected to best match the shooting conditions.

### 1 Press the button.



### 2 Use to select the setting option, and press the button to set.

Option	Description
FLASH AUTO	The flash fires automatically in low-light or backlight conditions.
REDEYE	Pre-flashes are emitted to reduce the occurrence of red eye in your photos.
FILL IN	The flash fires regardless of the available light.
FLASH OFF	The flash does not fire.

## Adjusting the brightness (Exposure compensation)

The standard brightness (appropriate exposure) set by the camera based on the shooting mode (except for **iAUTO**) can be adjusted brighter or darker to obtain a desired shot.

### 1 Press the button.

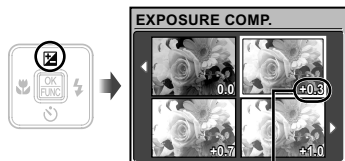

Exposure compensation value

### 2 Use to select the desired brightness, and press the button.

## Shooting closeups (Macro shooting)

This function enables the camera to focus and shoot subjects at close distances.

### 1 Press the button.



### 2 Use to select the setting option, and press the button to set.

Option	Description
OFF	Macro mode is deactivated.
MACRO	This enables shooting as close as 15 cm/5.9 in. <sup>1</sup> (60 cm/23.6 in. <sup>2</sup> ) to the subject.
SUPER MACRO <sup>3</sup>	This enables shooting as close as 10 cm/3.9 in. (FE-5020/X-935)/ 4 cm/1.6 in. (FE-4010/X-930) to the subject.

<sup>1</sup> When the zoom is at the widest (W) position.

<sup>2</sup> When the zoom is at the most telephoto (T) position.

<sup>3</sup> The zoom is automatically fixed.

 The flash (p. 19) and zoom (p. 19) cannot be set during super macro shooting.

## Using the self-timer

After the shutter button is pressed all the way down, the picture is taken after a short delay.

### 1 Press the button.



### 2 Use to select the desired setting option, and press the button to set.

Option	Description
OFF	The self-timer is deactivated.
ON	The self-timer lamp turns on for approx. 10 seconds, then blinks for approx. 2 seconds, and then the picture is taken.

 Self-timer shooting is automatically canceled after one shot.

**To cancel the self-timer after it starts**  
Press the  button again.

## Increasing the brightness of the monitor (Backlight boost)

Press  in shooting mode. The monitor becomes brighter. If there is no operation for 10 seconds, the previous brightness resumes.

## Changing the shooting information display

The display of the screen information can be changed to best match the situation, for example, the need for a clear view of the screen or for making a precise composition by using the grid display.

### 1 Press the DISP. button.

- The displayed shooting information changes in the order shown below each time the button is pressed. "Shooting mode display" (p. 8)

Normal

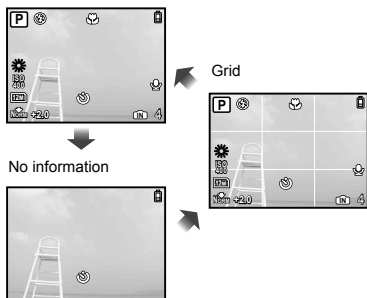

## Using the FUNC menu

The FUNC menu provides the following menu functions that can be quickly accessed and set.

- [WB] (p. 24)
- [IMAGE QUALITY] (p. 23)
- [ISO] (p. 24)

### 1 Press the button.

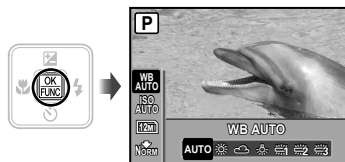

### 2 Use to select the menu function and to select the desired setting option, and then press the button to set.

# Using Playback Features

## Index view and close-up view

Index view enables quick selection of a desired image. Close-up view (up to 10x magnification) allows checking of image details.

### 1 Press the zoom buttons.

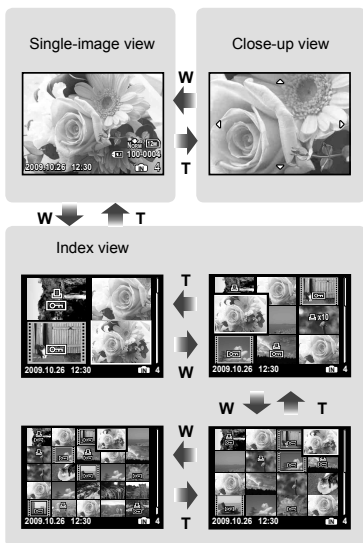

#### To select an image in index view

Use to select an image, and press the button to display the selected image in single-image view.

#### To scroll an image in close-up view

Use to move the viewing area.

## Changing the image information display

Shooting information settings displayed on the screen can be changed.

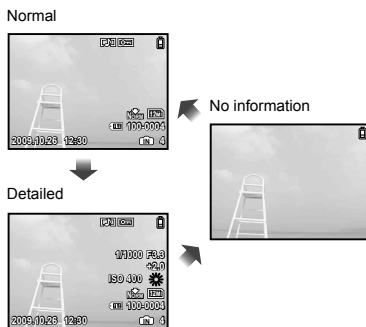

### 1 Press the DISP. button.

- The displayed image information changes in the order shown below each time the button is pressed.



# Menus for Shooting Functions

In shooting mode, settings can be adjusted.

-  indicates the mode in which the function can be set.
-  The default settings of the function are highlighted in  .

## Selecting the appropriate image quality for your application [ IMAGE QUALITY]

### IMAGE QUALITY

 P  iAUTO  SCN 

### Still pictures

Submenu 1	Submenu 2	Application
IMAGE SIZE	12M (3968×2976)	Suitable for printing pictures larger than A3 (11×17 in.).
	5M (2560×1920)	Suitable for printing A4 (8.5×11 in.) pictures.
	3M (2048×1536)	Suitable for printing pictures up to A4 (8.5×11 in.).
	2M (1600×1200)	Suitable for printing A5 (5×7 in.) pictures.
	1M (1280×960)	Suitable for printing pictures at postcard size.
	VGA (640×480)	Suitable for viewing pictures on a TV or using pictures in emails and on websites.
	16:9 (1920×1080)	Suitable for playing pictures on a wide screen TV.
COMPRESSION	FINE	Shooting at high quality.
	<span style="background-color: #cccccc;">NORMAL</span>	Shooting at normal quality.

### Movies

Submenu 1	Submenu 2	Application
IMAGE SIZE	VGA (640×480) / QVGA (320×240)	Select the image quality based on the image size and frame rate. Higher frame rates provide smoother movie images.
FRAME RATE	<span style="background-color: #cccccc;">30</span> 30fps <sup>*1</sup> / <span style="background-color: #cccccc;">15</span> 15fps <sup>*1</sup>	

<sup>\*1</sup> frames per second

-  "Number of storable pictures (still pictures)/Continuous recording length (movies) in the internal memory and xD-Picture Card" (p. 48)

## Adjusting to a natural color scheme [WB]

CAMERA MENU ► WB

P SCN

Submenu 2	Application
AUTO	The camera automatically adjusts the white balance according to the shooting scene.
	For shooting outdoors under a clear sky
	For shooting outdoors under a cloudy sky
	For shooting under tungsten lighting
	For shooting under daylight fluorescent lighting (household lighting, etc.)
	For shooting under neutral fluorescent lighting (desk lamps, etc.)
	For shooting under white fluorescent lighting (offices, etc.)

## Selecting the ISO sensitivity [ISO]

CAMERA MENU ► ISO

P

- ! Abbreviation for the International Organization for Standardization. ISO standards specify the sensitivity for digital cameras and film, thus codes such as "ISO 100" are used to represent sensitivity.
- ! In the ISO setting, although smaller values result in less sensitivity, sharp images can be taken under fully lit conditions. Larger values result in higher sensitivity, and images can be taken at fast shutter speeds even under low light conditions. However, High sensitivity introduces noise into the resulting picture, which may give it a grainy appearance.

Submenu 2	Application
AUTO	The camera automatically adjusts the sensitivity according to the shooting scene.
64/100/200/ 400/800/1600	The value of the ISO sensitivity is fixed.



### Shooting at higher magnifications than optical zoom without reducing the image quality [FINE ZOOM]

CAMERA MENU ► FINE ZOOM

: P **SCN**

Submenu 2	Application
OFF	Optical zoom and digital zoom are used to zoom in for shooting.
ON	Optical zoom and image cropping are combined to zoom in for shooting (FE-5020/X-935: up to 31x, FE-4010/X-930: up to 24.8x).

- This function will not reduce the image quality since it does not convert the data with fewer pixels into the data with larger pixels.
- When set to [ON], [IMAGE SIZE] is limited to [5M] or lower.
- When set to [ON], digital zoom is canceled automatically.
- [FINE ZOOM] is not available when [SUPER MACRO] (p. 20) is selected.

### Reducing blur due to camera shake during movie shooting [DIS MOVIE MODE]

CAMERA MENU ► DIS MOVIE MODE

:

Submenu 2	Application
OFF	Shoots without using the image stabilizing function.
ON	Shoots using the image stabilizing function.

- Image stabilization may not prevent motion blur caused by movement of the subject or by extreme movement of the camera.
- When set to [ON], shooting is slightly zoomed in.

### Recording sound when shooting still images [U]

CAMERA MENU ►

: P **SCN**

Submenu 2	Application
OFF	No sound is recorded.
ON	The camera automatically starts recording sound for approx. 4 seconds after a picture is taken. This is useful for recording notes or comments about the picture.

- When recording, aim the microphone (p. 6) at the source of the sound you want to record.

### Selecting sound setting for movies [U]

CAMERA MENU ►

:

Submenu 2	Application
OFF	No sound is recorded.
ON	Sound is recorded.

- When set to [ON], only the digital zoom can be used during movie recording. To record the movie with the optical zoom, set [U] (movies) to [OFF].

## Creating panoramic images [PANORAMA]

CAMERA MENU ► PANORAMA

SCN

Panorama shooting lets you create a panoramic picture, using the OLYMPUS Master 2 software on the provided CD-ROM.

- ! The focus, exposure (p. 14), zoom position (p. 19), and [WB] (p. 24) are locked at the first frame.
- ! The flash (p. 19) is fixed to (FLASH OFF) mode.
- ① Use to select the direction that the frames are combined.
- ② Press the shutter button to take the first frame, and then compose the second shot.
  - The part of the previous picture where it will be joined to the next picture does not remain in the frame. You have to remember what the part in the frame looked like and take the next picture so it overlaps.

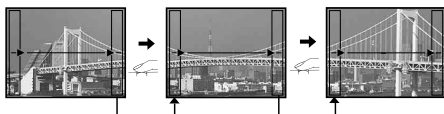

- ③ Repeat Step ② until the number of desired frames is taken, and then press the button when finished.
- ! When the mark is displayed, you cannot continue shooting any further. Panorama shooting is possible for up to 10 frames.
- ! Refer to the OLYMPUS Master 2 help guide for details on how to make panorama images.

## Selecting the focusing area [AF MODE]

CAMERA MENU ► AF MODE

SCN

Submenu 2	Application
FACE DETECT <sup>1)</sup>	This is used for taking pictures of people (The camera automatically detects a face and a frame appears). Press the shutter button halfway down, and when the face is in focus, the green AF target mark appears. The orange target mark indicates that the area other than the face is in focus.
iESP	This enables you to compose the shot without worrying about the focusing position. The camera finds the subject to focus on and automatically adjusts the focus.
SPOT	The camera focuses on the subject located within the AF target mark.
AF TRACKING	The camera tracks the subject movement automatically to focus on it continuously.

<sup>1)</sup> For some subjects, the frame may not appear or may take some time to appear.

### To focus on a moving subject continuously (AF Tracking)

- ① Hold the camera to align the AF target mark on the subject and press .
- ② When the camera recognizes the subject, the AF target mark automatically tracks the subject movement to focus on it continuously.
- ③ To cancel the tracking, press or any other buttons.
- ! Depending on the subjects or the shooting conditions, the camera may be unable to lock the focus or fail to track the subject movement.
- ! When the camera fails to track the subject movement, the AF target mark changes to red.

## Switching the shooting modes [ SWITCH SHOOTING MODES]

SWITCH SHOOTING MODES

: P iAUTO

Submenu 2	Application
<b>P</b>	Shooting with optimum aperture value and shutter speed (p. 14).
<b>iAUTO</b>	Shooting with automatic settings (p. 17).
DIS MODE	Using the digital image stabilization mode (p. 18).
<b>SCN</b>	Using the best mode for the shooting scene (p. 17).
MOVIE	Shooting movies (p. 18).

## Restoring the shooting functions to the default settings [ RESET]

RESET

: P iAUTO

Submenu 1	Application
YES	Restores the following menu functions to the default settings. <ul style="list-style-type: none"> <li>• Flash (p. 19)</li> <li>• Exposure compensation (p. 20)</li> <li>• Macro (p. 20)</li> <li>• Self-timer (p. 21)</li> <li>• [ IMAGE QUALITY] (p. 23)</li> <li>• [<b>SCN</b>] (p. 17)</li> <li>• Shooting information display (p. 21)</li> <li>• Menu functions in [ CAMERA MENU] (p. 24 to 26)</li> </ul>
NO	The current settings will not be changed.

## Shooting with special effects [ MAGIC FILTER]

MAGIC FILTER

: P

- Use to select the desired effect and press the button.
- After selecting the desired effect by pressing the button, all functions except zoom cannot be changed.

# Menus for Playback, Editing, and Printing Functions

Settings can be adjusted during image playback.

## Playing back pictures automatically [SLIDESHOW]

[SLIDESHOW]

### To start a slideshow

After pressing the [PLAY] button, the slideshow starts. To stop the slideshow, press the [STOP] button or the MENU button.

## Retouching images [PERFECT FIX]

[PERFECT FIX]

- ⚠ Edited or retouched images cannot be retouched again.
- ⚠ Depending on the picture, the editing may not be effective.
- ⚠ The retouching process may lower the image resolution.

Submenu 1	Application
ALL	[SHADOW ADJ] and [REDEYE FIX] are applied together.
SHADOW ADJ	Only sections darkened by backlighting and dim lighting are brightened.
REDEYE FIX	Eyes that are reddened by the flash are corrected.

- Use [SHADOW ADJ] or [REDEYE FIX] to select a correction method, and press the [OK] button.
- Use [LEFT] or [RIGHT] to select an image for retouching, and press the [OK] button.
  - The retouched image is saved as a separate image.

## Changing the image size [EDIT]

[EDIT]

Submenu 2	Application
VGA 640 × 480	This saves a high-resolution image as a separate image with a smaller size for use in e-mail attachments and other applications.
QVGA 320 × 240	

## Cropping image [CROP]

[CROP]

- Use [LEFT] or [RIGHT] to select an image, and press the [OK] button.
- Use the zoom buttons to select the size of the cropping frame, and use [UP] [DOWN] [LEFT] [RIGHT] to move the frame.



- Press the [OK] button.
  - The edited image will be saved as a separate image.

## Creating an index of 9 frames from a movie [INDEX]

PLAYBACK MENU ► INDEX



- Use to select a movie, and press the button.
- Use to select the first frame, and press the button.
- Use to select the last frame, and press the button.
  - 9 frames are extracted from a movie and saved as a new still image (INDEX).

## Protecting images [ON]

PLAYBACK MENU ► ON

- Protected images cannot be erased by [ERASE] (p. 16), [SEL. IMAGE], or [ALL ERASE] (p. 30), but all images are erased by [MEMORY FORMAT]/[FORMAT] (p. 31).

Submenu 2	Application
OFF	Images can be erased.
ON	Images are protected so that they cannot be erased except by formatting of the internal memory/card.

- Use to select an image.
- Use to select [ON].
- If necessary, repeat Steps ① and ② to protect other images, and press the button.

## Rotating images [↻]

PLAYBACK MENU ►

Submenu 2	Application
+90°	The image is rotated 90° clockwise.
0°	The image is not rotated.
-90°	The image is rotated 90° counter-clockwise.

- Use to select an image.
- Use to select the rotation direction.
- If necessary, repeat Steps ① and ② to make settings for other images, and press the button.
  - The new picture orientations will be saved even after the power is turned off.

## Adding sound to still images [🎤]

PLAYBACK MENU ►

Submenu 2	Application
YES	The camera adds (records) sound for approx. 4 seconds while playing back the image. This is useful for recording notes or comments about the image.
NO	No sound is recorded.

- Use to select an image, and press the button.
- Aim the microphone toward the sound source.

FE-5020/X-935

FE-4010/X-930

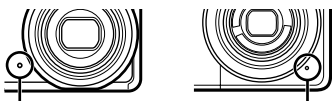

Microphone

- Use to select [YES], and press the button.
  - Recording starts.

## Erasing images [ERASE]



Submenu 1	Application
SEL. IMAGE	Images are individually selected and erased.
ALL ERASE	All images in the internal memory or card will be erased.

- ! When erasing pictures in the internal memory, do not insert the card into the camera.
- ! When erasing pictures from the card, insert a card into the camera in advance.

### To individually select and erase images [SEL. IMAGE]

- Use to select [SEL. IMAGE], and press the button.
- Use to select the image to be erased, and press the button to add a ✓ mark to the image.



- Repeat Step ② to select the images to be erased, and then press the button to erase the selected images.
- Use to select [YES], and press the button.
  - The images with a ✓ mark are erased.

### To erase all images [ALL ERASE]

- Use to select [ALL ERASE], and press the button.
- Use to select [YES], and press the button.

## Saving print settings to the image data [PRINT ORDER]



- ! "Print reservations (DPOF)" (p. 38)
- ! Print reservation can be set only for still images that are recorded to the card.

## Menus for Other Camera Settings

### Erasing data completely [MEMORY FORMAT]/[FORMAT]

 SETUP ► MEMORY FORMAT/FORMAT

- ! Before formatting, check that no important data is left in the internal memory or card.
- ! Non-Olympus cards and cards that have been formatted by a computer must be formatted with this camera before use.

Submenu 2	Application
YES	Completely erases the image data in the internal memory <sup>*1</sup> or card (including protected images).
NO	Cancels formatting.

<sup>\*1</sup> Be sure to remove the card before formatting the internal memory.

### Copying images in the internal memory to the card [BACKUP]

 SETUP ► BACKUP

Submenu 2	Application
YES	Backs up image data in the internal memory to the card.
NO	Cancels the backup.

- ! It takes some time to back up data. Check that the battery has sufficient power before starting the backup.

### Changing the display language [🌐]

 SETUP ► 

- ! "Changing the display language" (p. 13)

Submenu 2	Application
Languages <sup>*1</sup>	The language for the menus and error messages displayed on the monitor is selected.

<sup>\*1</sup> The available languages vary depending on the country and/or region where the camera was purchased.

### Adjusting the CCD and the image processing function [PIXEL MAPPING]

 SETUP ► PIXEL MAPPING



- ! This function has already been adjusted at factory shipping, and no adjustment is needed right after purchase. Approximately once a year is recommended.
- ! For best results, wait at least one minute after taking or viewing pictures before performing pixel mapping. If the camera is turned off during pixel mapping, be sure to perform it again.



#### To adjust the CCD and the image processing function

Press the  button when [START] (Submenu 2) is displayed.

- The camera checks and adjusts the CCD and the image processing function at the same time.

### Turning on the camera with the or button [/▶]

 SETUP ► /▶

Submenu 2	Application
YES	Pressing  turns on the camera and starts the camera in the shooting mode. Pressing  turns on the camera and starts the camera in the playback mode.
NO	The power is not turned on. To turn on the camera, press the ON/OFF button.

## Saving the mode when the camera is turned off [SAVE SETTINGS]

 SETUP ► SAVE SETTINGS

Submenu 2	Application
YES	The shooting mode is saved when the camera is turned off and is reactivated the next time the camera is turned on.
NO	The shooting mode is set to <b>P</b> mode when the camera is turned on.



## Setting the startup display screen and sound when the camera is turned on [PW ON SETUP]

 SETUP ► PW ON SETUP

Submenu 2	Submenu 3	Application
SCREEN	OFF	No image is displayed.
	1	A preset image <sup>*1</sup> is displayed.
	2	A still image stored in the internal memory or card is registered for display. (This option leads to the setup screen.)
VOLUME	OFF (No sound)/ LOW/HIGH	The volume of the startup sound is selected.

\*1 This image cannot be changed.

### To register a startup image

- 1 Select [2] in Submenu 3 for [SCREEN].
- 2 Use   to select the image to be registered, and press the  button.

## Selecting the menu screen color and background [MENU COLOR]

 SETUP ► MENU COLOR

Submenu 2	Application
NORMAL/ COLOR 1/ COLOR 2/ COLOR 3	Selects the menu screen color or background image according to your preference.



## Selecting the camera sound and its volume [SOUND SETTINGS]

### SETUP ► SOUND SETTINGS

! To turn off all sounds at once, make the setting from [SILENT MODE] (p. 34).

Submenu 2	Submenu 3	Submenu 4	Application
BEEP	SOUND TYPE	1/2	Selects the operating sound and volume of the camera buttons (except the shutter button).
	VOLUME	OFF (No sound)/ LOW/HIGH	
SHUTTER SOUND	SOUND TYPE	1/2/3	Selects the type and volume of the shutter sound.
	VOLUME	OFF (No sound)/ LOW/HIGH	
■))	OFF (No sound)/ LOW/HIGH	—	Adjusts the warning sound volume.
▣ VOLUME	OFF (No Sound) or 5 levels of volume	—	Adjusts the image playback volume.

## Adjusting the brightness of the monitor [MONITOR]

### SETUP ► MONITOR

Submenu 2	Application
BRIGHT/ NORMAL	Selects the monitor brightness depending on the surrounding brightness.

## Setting the date and time [DATE/TIME]

### SETUP ► DATE/TIME

! “Setting the date and time” (p. 13)

### To select the date display order

- Press after setting Minute, and use to select the date display order.

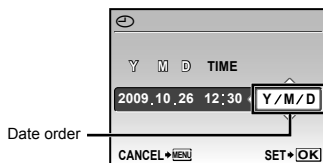

## Selecting a video signal system to match your TV [VIDEO OUT]

### SETUP ► VIDEO OUT

- ⚠ The TV video signal system varies depending on the countries and regions. Before viewing camera images on your TV, select the video output according to your TV's video signal type.

Submenu 2	Application
NTSC	Connecting the camera to a TV in North America, Taiwan, Korea, Japan, and so on.
PAL	Connecting the camera to a TV in European countries, China, and so on.

- ⚠ The factory default settings differ according to the region where the camera is sold.

### To play back camera images on a TV

- ① Connect the TV and camera.

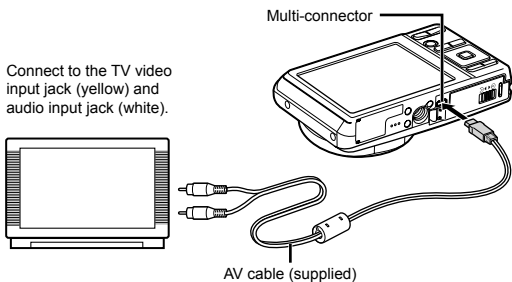

- ② Use the camera to select the same video signal system as the one of connected TV ((NTSC)/(PAL)).
- ③ Turn on the TV, and change "INPUT" to "VIDEO (an input jack connected to the camera)."
- ⚠ For details on changing the input source of the TV, refer to the TV's instruction manual.
- ④ Press the **▶** button, and use **◀ ▶ ⏪ ⏩** to select the image for playback.
- ⚠ Depending on the TV's settings, the displayed images and information may become cropped.

## Saving battery power between shots [POWER SAVE]

### SETUP ► POWER SAVE

Submenu 2	Application
OFF	Cancels [POWER SAVE].
ON	When the camera is not being used for approx. 10 seconds, the monitor automatically turns off to save battery power.

### To resume standby mode

Press any button.

## Turning off the camera sounds [SILENT MODE]

### SILENT MODE

Submenu 1	Application
OFF	Button operation sound/shutter sound/warning sound/sound of image playback of pictures are not muted.
ON	The electronic sounds (button operation sound, shutter sound, warning sound) and playback sounds are muted.

- ⚠ [SOUND SETTINGS] (p. 33)

# Printing

## Direct printing (PictBridge<sup>1</sup>)

By connecting the camera to a PictBridge-compatible printer, you can print images directly without using a computer.

To find out if your printer supports PictBridge, refer to the printer's instruction manual.

<sup>1</sup> PictBridge is a standard for connecting digital cameras and printers of different makers and printing out pictures directly.

- ! The printing modes, paper sizes, and other parameters that can be set with the camera vary depending on the printer that is used. For details, refer to the printer's instruction manual.
- ! For details on the available paper types, loading paper, and installing ink cassettes, refer to the printer's instruction manual.

## Printing images at the printer's standard settings [EASY PRINT]

### 1 Display the image to be printed on the monitor.

- ! "Viewing images" (p. 15)
- ! Printing can also be started when the camera is turned off. After performing Step 2, use  $\leftarrow$   $\rightarrow$   $\leftarrow$   $\rightarrow$  to select [EASY PRINT], press the  $\left[\text{OK}\right]$  button. Use  $\left[\right]$   $\left[\leftarrow\right]$  to select an image, and press the  $\left[\text{OK}\right]$  button.

### 2 Turn on the printer, and then connect the printer and camera.

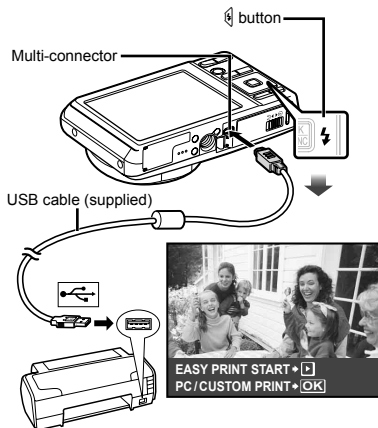

### 3 Press $\left[\right]$ to start printing.

### 4 To print another image, use $\left[\right]$ $\left[\leftarrow\right]$ to select an image, and press the $\left[\text{OK}\right]$ button.

#### To exit printing

After a selected image is displayed on the screen, disconnect the USB cable from the camera and printer.



## Changing the printer's settings for printing [CUSTOM PRINT]

- 1** Follow Steps 1 and 2 for [EASY PRINT] (p. 35), and press the button.

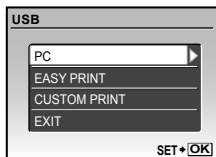

- 2** Use to select [CUSTOM PRINT], and press the button.

- 3** Use to select the print mode, and press the button.

Submenu 2	Application
PRINT	This prints the image selected in Step 6.
ALL PRINT	This prints all images stored in the internal memory or card.
MULTI PRINT	This prints one image in a multiple layout format.
ALL INDEX	This prints an index of all images stored in the internal memory or card.
PRINT ORDER <sup>1</sup>	This prints images based on the print reservation data on the card.

<sup>1</sup> [PRINT ORDER] is available only when print reservations have been made. "Print Reservations (DPOF)" (p. 38)

- 4** Use to select [SIZE] (Submenu 3), and press .

- If the [PRINTPAPER] screen is not displayed, the [SIZE], [BORDERLESS], and [PICS/SHEET] are set to the printer's standard.

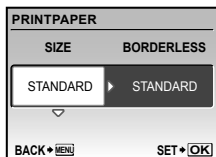

- 5** Use to select the [BORDERLESS] or [PICS/SHEET] settings, and press the .

Submenu 4	Application
OFF/ON <sup>1</sup>	The image is printed with a border around it ([OFF]). The image is printed to fill the entire paper ([ON]).
(The number of images per sheet varies depending on the printer.)	The number of images per sheet ([PICS/SHEET]) is selectable only when [MULTI PRINT] is selected in Step 3.

<sup>1</sup> The available settings for [BORDERLESS] vary depending on the printer.

- If [STANDARD] is selected in Steps 4 and 5, the image is printed at the printer's standard settings.



- 6** Use to select an image.

- 7** Press to make a print reservation for the current image. Press to make the detailed printer settings for the current image.

### To make the detailed printer settings

- 1** Use to select the setting, and press the .

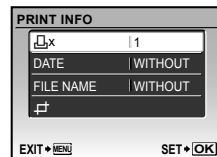

Submenu 5	Submenu 6	Application
	0 to 10	This selects the number of prints.
DATE	WITH/ WITHOUT	Selecting [WITH] prints the images with the date. Selecting [WITHOUT] prints the images without the date.
FILE NAME	WITH/ WITHOUT	Selecting [WITH] prints the file name on the image. Selecting [WITHOUT] does not print any file name on the image.
	(Proceeds to the setting screen.)	This selects a portion of the image for printing.

### To crop an image []

- Use the zoom buttons to select the size of the cropping frame, use to move the frame, and then press the button.

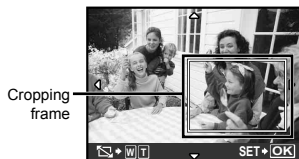

- Use to select [OK], and press the button.



- If necessary, repeat Steps 6 and 7 to select the image to be printed, make the detailed settings, and set [SINGLEPRINT].

- Press the button.

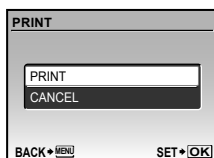

- Use to select [PRINT], and press the button.

- Printing starts.
- When [OPTION SET] is selected in [ALL PRINT] mode, [PRINT INFO] screen is displayed.
- When printing is finished, the [PRINT MODE SELECT] screen is displayed.

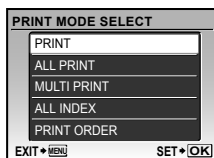

### To cancel printing

- When [TRANSFERRING] is displayed, press the button, use to select [CANCEL], and then press the button again.

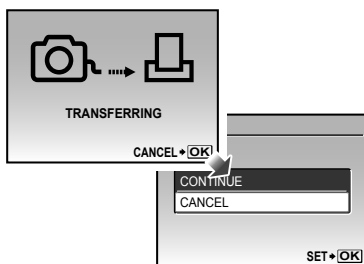

- Press the MENU button.

- When the message [REMOVE USB CABLE] is displayed, disconnect the USB cable from the camera and printer.

## Print Reservations (DPOF<sup>1</sup>)

In print reservations, the number of prints and date imprint option are saved in the image on the card. This enables easy printing at a printer or print shop supporting DPOF by using only the print reservations on the card without a computer or a camera.

- <sup>1</sup> DPOF is a standard for storing automatic printout information from digital cameras.
- Print reservations can be set only for the images stored on the card. Insert a card with recorded images before making print reservations.
  - DPOF reservations set by another DPOF device cannot be changed by this camera. Make changes using the original device. Making new DPOF reservations with this camera will erase the reservations made by the other device.
  - DPOF print reservations can be made for up to 999 images per card.

## Single-frame print reservations [ ]

- Press the button, and then press the MENU button to display the top menu.
- Use to select [PRINT ORDER], and press the button.

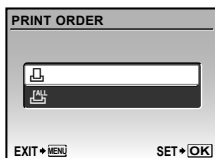

- Use to select [ ], and press the button.

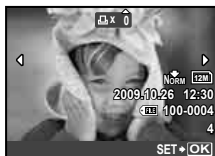

- Use to select the image for print reservation. Use to select the quantity. Press the button.



- Use to select the [ ] (date print) screen option, and press the button.

Submenu 2	Application
NO	This prints the image only.
DATE	This prints the image with the shooting date.
TIME	This prints the image with the shooting time.



- Use to select [SET], and press the button.

## Reserving one print each of all images on the card [ALL]

- 1 Follow Steps 1 and 2 in [ ] (p. 38).
- 2 Use to select [ALL], and press the button.
- 3 Follow Steps 5 and 6 in [ ].

## Resetting all print reservation data

- 1 Press the button, and then press the MENU button to display the top menu.
- 2 Use to select [PRINT ORDER], and press the button.
- 3 Select either [ ] or [ALL], and press the button.

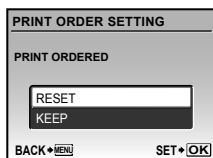

- 4 Use to select [RESET], and press the button.

## Resetting the print reservation data for selected images

- 1 Follow Steps 1 and 2 of “Resetting all print reservation data” (p. 39).
- 2 Use to select [ ], and press the button.
- 3 Use to select [KEEP] and press the button.
- 4 Use to select the image with the print reservation you want to cancel. Use to set the print quantity to “0”.
- 5 If necessary, repeat Step 4, and then press the button when finished.
- 6 Use to select the [ ] (date print) screen option, and press the button.
  - The settings are applied to the remaining images with the print reservation data.
- 7 Use to select [SET], and press the button.

# Using OLYMPUS Master 2

## System requirements and installation of OLYMPUS Master 2

Install the OLYMPUS Master 2 software by referring to the included installation guide.

## Connecting the camera to a computer

### 1 Make sure the camera is turned off.

- The monitor is off.
- The lens is retracted.

### 2 Connect the camera to a computer.

- The camera automatically turns on.

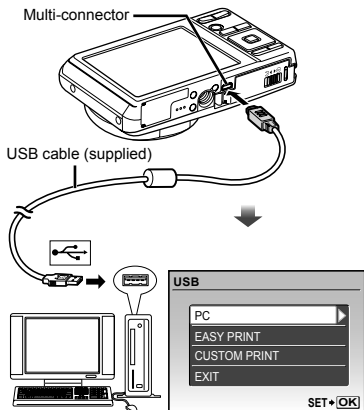

- ! Locate the position of the USB port by referring to your computer's instructions manual.

### 3 Use to select [PC], and press the button.

- The computer automatically detects the camera as a new device on the first connection.

## Windows

After the computer detects the camera, a message indicating setup completion appears. Confirm the message and click "OK". The camera is recognized as a removable disk.

## Macintosh

If iPhoto has started, exit iPhoto and start OLYMPUS Master 2.

- ! While the camera is connected to the computer, shooting functions are disabled.
- ! Connecting the camera to a computer via a USB hub may cause unstable operation.
- ! When [MTP] is set for the submenu that appears by pressing after selecting [PC] in Step 3, images cannot be transferred to a computer using OLYMPUS Master 2.

## Starting OLYMPUS Master 2

### 1 Double-click the OLYMPUS Master 2 icon.

## Windows

appears on the desk top.

## Macintosh

appears in the OLYMPUS Master 2 folder.

- Browse window appears after starting the software.
- ! When you start OLYMPUS Master 2 for the first time after installation, "Default Settings" and "Registration" screen appear. Follow the instructions on the screen.



## **Operating OLYMPUS Master 2**

When OLYMPUS Master 2 is started, the Quick Start Guide appears with step-by-step instructions for common tasks. When the Quick Start Guide is not displayed, click  in the tool bar to show the Guide.

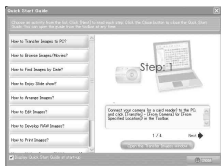

For details on the operation, refer to the help guide of the software.

## **Transferring and saving images without using OLYMPUS Master 2**

This camera is compatible with the USB Mass Storage Class. You can transfer and save the image data on your computer while the camera and the computer are connected.

### **System requirements**

Windows : Windows 2000 Professional/  
XP Home Edition/  
XP Professional/Vista

Macintosh : Mac OS X v10.3 or later

- ! On a computer running Windows Vista, if [MTP] is set for the submenu that appears by pressing  after selecting [PC] in Step 3 of "Connecting the camera to a computer" (p. 40), Windows Photo Gallery will become available.
- ! Even if a computer has USB ports, proper operation is not guaranteed in the following cases.
  - computers with USB ports installed using an expansion card, etc.
  - computers without a factory-installed OS and home-built computers



# Usage Tips

If the camera does not work as intended, or if an error message is displayed on the screen, and you are unsure of what to do, refer to the information below to fix the problem(s).

## Troubleshooting

### Battery

**“The camera does not work even when batteries are installed”.**

- Insert recharged batteries in the correct direction.  
“Charging the battery” (p. 10), “Loading the battery and the xD-Picture Card™ (sold separately) into the camera” (p. 11)
- Battery performance may have been reduced temporarily due to low temperature. Take the batteries out of the camera, and warm them by putting them in your pocket for a while.



### Card/Internal memory

**“An error message is displayed”.**

“Error message” (p. 43)

### Shutter button

**“No picture is taken when the shutter button is pressed”.**

- Cancel sleep mode.  
To save battery power, the camera automatically goes into sleep mode and the monitor turns off if there is no operation for 3 minutes when the camera is turned on. No picture is taken even if the shutter button is fully pressed in this mode. Operate the zoom buttons or other buttons to restore the camera from sleep mode before taking a picture. If the camera is left for another 12 minutes, it automatically turns off. Press the ON/OFF button to turn the camera on.
- Press the  button to set a shooting mode.
- Wait until  (flash charge) stops blinking before taking pictures.
- With prolonged camera use, the internal temperature may increase, resulting in automatic shutdown. If this occurs, remove the battery from the camera and wait until the camera has sufficiently cooled. The camera's external temperature may also increase during use, however this is normal and does not indicate malfunction.

### Monitor

**“Difficult to see”.**

- Condensation<sup>1</sup> may have occurred. Turn off the power, and wait for the camera body to become acclimated to the surrounding temperature and dry out before taking pictures.  
<sup>1</sup> Dew drops can form in the camera when it is suddenly taken from a cold location into a warm, humid room.

**“Vertical lines appear on the screen”.**

- This condition may occur when the camera is pointed at an extremely bright subject under a clear sky and so on. The lines do not appear, however, in the final image.

**“The light is caught in the picture”.**

- Shooting with flash in dark situations results in an image with many flash reflections on dust in the air.

### Date and time function

**“Date and time settings return to the default setting”.**

- If the batteries are removed and left out of the camera for about a day<sup>2</sup>, the date and time settings return to the default setting, and must be reset.  
<sup>2</sup> The time until the date and time settings return to the default setting varies depending on how long the batteries have been loaded.
- “Setting the date and time” (p. 13)















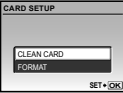







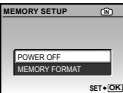

### Miscellaneous









**“The camera makes a noise when taking pictures”.**

- The camera may activate the lens and make a noise even if no operation is performed. This is because the camera automatically performs actions of auto focus as far as it is ready to shoot.

## Error message

-  When one of the messages below is displayed on the monitor, check the corrective action.

Error message	Corrective action
 <b>CARD ERROR</b>	<b>Card problem</b> Insert a new card.
 <b>WRITE PROTECT</b>	<b>Card problem</b> Use a computer to cancel the read-only setting.
 <b>MEMORY FULL</b>	<b>Internal memory problem</b> <ul style="list-style-type: none"> <li>• Insert a card.</li> <li>• Erase unwanted images.<sup>1</sup></li> </ul>
 <b>CARD FULL</b>	<b>Card problem</b> <ul style="list-style-type: none"> <li>• Replace the card.</li> <li>• Erase unwanted images.<sup>1</sup></li> </ul>
 <b>CARD SETUP</b> 	<b>Card problem</b> <ul style="list-style-type: none"> <li>• Use   to select [CLEAN CARD], and press the  button. Take out the card, wipe the contact area (p. 47) with a soft, dry cloth, and then load the card again.</li> <li>• Use   to select [FORMAT], and press the  button. Next, use   to select [YES], and press the  button.<sup>2</sup></li> </ul>
 <b>MEMORY SETUP</b> 	<b>Internal memory problem</b> Use   to select [MEMORY FORMAT], and press the  button. Next, use   to select [YES], and press the  button. <sup>2</sup>
 <b>NO PICTURE</b>	<b>Internal memory/Card problem</b> Take pictures before viewing them.
 <b>PICTURE ERROR</b>	<b>Problem with selected image</b> Use photo retouch software, etc. to view the image on a computer. If the image still cannot be viewed, the image file is corrupted.
 <b>THE IMAGE CANNOT BE EDITED</b>	<b>Problem with selected image</b> Use photo retouch software, etc. to edit the image on a computer.

 <b>CARD-COVER OPEN</b>	<b>Operation problem</b> Close the battery/card compartment cover.
 <b>BATTERY EMPTY</b>	<b>Battery problem</b> Charge the battery.
 <b>NO CONNECTION</b>	<b>Connection problem</b> Connect the camera and computer or printer correctly.
 <b>NO PAPER</b>	<b>Printer problem</b> Load paper into the printer.
 <b>NO INK</b>	<b>Printer problem</b> Refill the ink in the printer.
 <b>JAMMED</b>	<b>Printer problem</b> Remove the jammed paper.
 <b>SETTINGS CHANGED</b> <sup>3</sup>	<b>Printer problem</b> Return to the status where the printer can be used.
 <b>PRINT ERROR</b>	<b>Printer problem</b> Turn off the camera and printer, check the printer for any problems, and then turn the power on again.
 <b>CANNOT PRINT</b> <sup>4</sup>	<b>Problem with selected image</b> Use a computer to print.

<sup>1</sup> Before erasing important images, download them to a computer.

<sup>2</sup> All data will be erased.

<sup>3</sup> This is displayed, for instance, when the printer's paper tray has been removed. Do not operate the printer while making the print settings on the camera.

<sup>4</sup> This camera may be unable to print images taken by other cameras.

## Shooting tips

When you are unsure of how to take a picture that you envision, refer to the information below.

### Focusing



#### “Focusing on the subject”

- **Taking a picture of a subject not in the center of the screen**

After focusing on an object at the same distance as the subject, compose the shot, and take the picture.

Pressing the shutter button halfway (p. 14)

- **Set [AF MODE] (p. 26) to [IESP]**
- **Taking a picture in [AF TRACKING] mode (p. 26)**

The camera tracks the subject movement automatically to focus on it continuously.

- **Taking a picture of subjects where autofocus is difficult**

In the following cases, after focusing on an object (by pressing the shutter button halfway down) with high contrast at the same distance as the subject, compose the shot, and take the picture.

Subjects with low contrast



When extremely bright objects appear in the center of the screen



Object with no vertical lines<sup>\*1</sup>

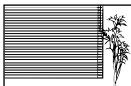

<sup>\*1</sup> It is also effective to compose the shot by holding the camera vertically to focus, and then returning to the horizontal position to take the picture.

When objects are at different distances



Fast-moving object

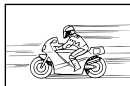

The subject is not in the center of the frame



### Camera shake



#### “Taking pictures without camera shake”

- **Taking pictures using [M] mode (p. 18)**
- **Select [SPORT] in [SCN] mode (p. 17)**

The [SPORT] mode uses a fast shutter speed and can reduce the blur incurred by a moving subject.

- **Taking pictures at a high ISO sensitivity**

If a high ISO sensitivity is selected, pictures can be taken at a high shutter speed even at locations where a flash cannot be used.

[ISO] (p. 24)

### Exposure (brightness)



#### “Taking pictures with the right brightness”

- **Taking pictures using [FACE DETECT] (p. 26)**

Appropriate exposure is obtained for a face against backlight, and the face is brightened.

- **Taking pictures using [FILL IN] (p. 19) flash**

A subject against backlight is brightened.

- **Taking pictures using exposure compensation (p. 20)**

Adjust the brightness while viewing the screen for taking the picture. Normally, taking pictures of white subjects (such as snow) results in images that are darker than the actual subject. Use the [ ] button to adjust in the positive (+) direction to express whites as they appear. When taking pictures of black subjects, on the other hand, it is effective to adjust in the negative (-) direction.

## Color hue

WB

### “Taking pictures with colors at the same shade as they appear”

- **Taking pictures by selecting [WB] (p. 24)**

Best results in most environments can normally be obtained with the AUTO setting, but for some subjects, you should try experimenting with different settings. (This is especially true for sunshade under a clear sky, mixed natural and artificial light settings, and so on.)

- **Taking pictures using [FILL IN] (p. 19) flash**

Use of the flash is also effective for shooting under fluorescent and other artificial lighting.

## Image quality



### “Taking sharper pictures”

- **Taking pictures with the optical zoom**

Avoid using digital zoom (p. 19) to take pictures.

- **Taking pictures at a low ISO sensitivity**

If the picture is taken with a high ISO sensitivity, noise (small colored spots and color unevenness that were not in the original image) can occur, and the image can appear grainy. The resulting image is grainier than with low ISO sensitivity as well.

[ISO] (p. 24)

## Batteries



### “Making batteries last longer”

- **Avoid any of the following operations when not actually taking pictures because they deplete the battery power**

- Repeatedly pressing the shutter button halfway
- Repeatedly using the zoom

- **Set [POWER SAVE] (p. 34) to [ON]**

## Playback/Editing tips

### Playback



#### “Playing images in the internal memory and card”

- **Remove the card when playing pictures in the internal memory**

- “Loading the battery and the xD-Picture Card™ (sold separately) into the camera” (p. 11)
- “Using the microSD card/microSDHC card (sold separately)” (p. 12)

### Editing



#### “Erasing the sound recorded to a still image”

- **Record over the sound with silence when playing back the image**

“Adding sound to still images [🔊]” (p. 29)

# Appendix

## Camera care

### Exterior

- Wipe gently with a soft cloth. If the camera is very dirty, soak the cloth in mild soapy water and wring well. Wipe the camera with the damp cloth and then dry it with a dry cloth. If you have used the camera at the beach, use a cloth soaked in clean water and wrung well.

### Monitor

- Wipe gently with a soft cloth.

### Lens

- Blow dust off the lens with a commercial blower, then wipe gently with a lens cleaner.

### Battery/Charger

- Wipe gently with a soft, dry cloth.
  - ! Do not use strong solvents such as benzene or alcohol, or chemically treated cloth.
  - ! Mold may form on the lens surface if the lens is left dirty.

## Storage

- When storing the camera for extended periods, remove the battery and card, and keep in a cool, dry place that is well ventilated.
- Periodically insert the battery and test the camera functions.
  - ! Avoid leaving the camera in places where chemical products are handled since this may result in corrosion.

## Battery and charger

- This camera uses one Olympus lithium ion battery (LI-42B/LI-40B). No other type of batteries can be used.
  - ! **Caution:**  
There is a risk of explosion if the battery is replaced with the incorrect battery type. Dispose of the used battery following the instructions. (p. 52)
- Power consumption by the camera varies depending on which functions are used.
- During the conditions described below, power is consumed continuously and the battery becomes exhausted quickly.
  - The zoom is used repeatedly.
  - The shutter button is pressed halfway repeatedly in shooting mode, activating the auto focus.
  - A picture is displayed on the monitor for an extended period of time.
  - The camera is connected to a computer or printer.
- Using an exhausted battery may cause the camera to turn off without displaying the battery level warning.
- The rechargeable battery is not fully charged at the time of purchase. Charge the battery fully with the LI-41C/LI-40C charger before use.
- The provided rechargeable battery usually takes approximately 2 hours to charge (varies on usage).
- The supplied LI-41C battery charger is used only for LI-42B/LI-40B batteries. Do not charge any other type of battery with the supplied battery charger. It might cause explosion, leaking, overheating or fire.
- For plug-in type battery charger:  
This power unit is intended to be correctly orientated in a vertical or floor mount position.

## Using your charger abroad

- The charger can be used in most home electrical sources within the range of 100 V to 240 V AC (50/60Hz) around the world. However, depending on the country or area you are in, the AC wall outlet may be shaped differently and the charger may require a plug adapter to match the wall outlet. For details, ask at your local electrical shop or travel agent.
- Do not use travel voltage converters as they could damage your charger.

## Using an xD-Picture Card

A card (and internal memory) also corresponds to the film that records images in a film camera. Otherwise, the recorded images (data) can be erased, and retouching is also available with the use of a computer. Cards can be removed from the camera and exchanged, but this is not possible with the internal memory. Use of larger capacity cards enables you to take more pictures.

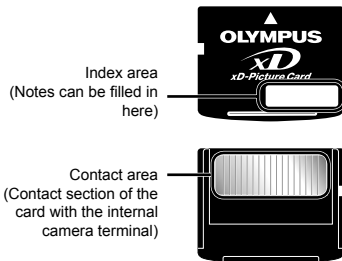

⚠ Do not touch the contact area directly.

### Cards compatible with this camera

xD-Picture Card (16MB to 2GB)  
(TypeH/M/M+, Standard)

### Using a new card

Before using a non-Olympus card or a card that was used for another purpose in a computer or other device, use [MEMORY FORMAT]/[FORMAT] (p. 31) to format the card.

### Checking the image saving location

The memory indicator shows whether the internal memory or card is being used during shooting and playback.

### Current memory indicator

☑ Internal memory is being used

None: Card is being used

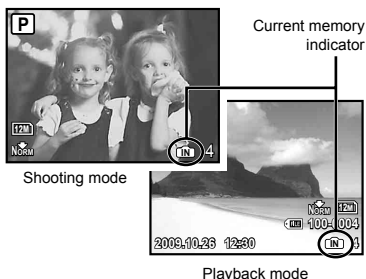

⚠ Even if [MEMORY FORMAT]/[FORMAT], [ERASE], [SEL. IMAGE], or [ALL ERASE] is performed, the data in the card is not completely erased. When disposing of the card, damage the card to prevent the disclosure of personal data.

### Readout/recording process of the card

Never open the battery/card compartment cover or unplug the USB cable while the camera is reading or writing data, which is indicated by blinking of the card access lamp. This can not only damage the image data but also render the internal memory or card unusable.

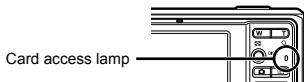

## Number of storable pictures (still pictures)/Continuous recording length (movies) in the internal memory and xD-Picture Card

### Still pictures

IMAGE SIZE		COMPRESSION	Number of storable still pictures			
			Internal memory		Using a 1GB xD-Picture Card	
			With sound	Without sound	With sound	Without sound
12M	3968×2976	FINE	8	8	173	174
		NORM	16	16	340	343
5M	2560×1920	FINE	19	19	404	410
		NORM	36	37	770	789
3M	2048×1536	FINE	30	31	646	659
		NORM	60	62	1,254	1,305
2M	1600×1200	FINE	49	51	1,031	1,066
		NORM	92	98	1,938	2,063
1M	1280×960	FINE	74	78	1,560	1,640
		NORM	139	153	2,907	3,198
VGA	640×480	FINE	236	278	4,920	5,814
		NORM	383	511	7,995	10,660
16:9	1920×1080	FINE	45	47	954	984
		NORM	87	92	1,827	1,938

### Movies

IMAGE SIZE		FRAME RATE	Continuous recording length			
			Internal memory		Using a 1 GB xD-Picture Card	
			With sound	Without sound	With sound	Without sound
VGA	640×480	30	27 sec.	27 sec.	9 min. 25 sec.*	9 min. 28 sec.*
		15	53 sec.	54 sec.	18 min. 44 sec.	18 min. 56 sec.
QVGA	320×240	30	1 min. 13 sec.	1 min. 14 sec.	25 min. 26 sec.	25 min. 49 sec.
		15	2 min. 24 sec.	2 min. 28 sec.	50 min. 7 sec.	51 min. 38 sec.

 The maximum file size of a single movie is 2 GB, regardless of the capacity of the card.

\* When using a TypeM or Standard xD-Picture Card, the maximum recording length will be 40 seconds.

### Increasing the number of pictures that can be taken

Either erase unwanted images, or connect the camera to a computer or other device to save the images, and then erase the images in the internal memory or card.

[ERASE] (p. 16), [SEL. IMAGE] (p. 30), [ALL ERASE] (p. 30), [MEMORY FORMAT]/[FORMAT] (p. 31)



## Using the microSD Attachment

- Do not use the attachment with Olympus digital cameras that do not support this microSD Attachment, as well as with other brands of digital cameras, computers, printers, and other devices that support xD-Picture Card. Doing so not only may damage the pictures taken, but may also result in the malfunction of the device.
- If the microSD card cannot be removed, do not use force. Contact authorized distributors/service centers.

### Cards compatible with this camera

microSD card/microSDHC card

- For a list of tested microSD cards, please visit our website (<http://www.olympus.com/>).

### Sending images



You can send images to a computer or a PictBridge printer by using the USB cable provided with the camera.

To send data to other devices, remove the attachment from the camera and use a commercially available microSD card adapter.

### Handling precautions

Do not touch the contact area of the attachment or microSD card. Doing so may cause failure in reading the images. When fingerprints or stains are found on the contact area, wipe the area with a soft dry cloth.

## SAFETY PRECAUTIONS

	<b>CAUTION</b> <b>RISK OF ELECTRICAL SHOCK</b> <b>DO NOT OPEN</b>	
CAUTION: TO REDUCE THE RISK OF ELECTRICAL SHOCK, DO NOT REMOVE COVER (OR BACK). NO USER-SERVICEABLE PARTS INSIDE. REFER SERVICING TO QUALIFIED OLYMPUS SERVICE PERSONNEL.		



An exclamation mark enclosed in a triangle alerts you to important operating and maintenance instructions in the documentation provided with the product.



**DANGER**

If the product is used without observing the information given under this symbol, serious injury or death may result.



**WARNING**

If the product is used without observing the information given under this symbol, injury or death may result.



**CAUTION**

If the product is used without observing the information given under this symbol, minor personal injury, damage to the equipment, or loss of valuable data may result.

### WARNING!

**TO AVOID THE RISK OF FIRE OR ELECTRICAL SHOCK, NEVER DISASSEMBLE, EXPOSE THIS PRODUCT TO WATER OR OPERATE IN A HIGH HUMIDITY ENVIRONMENT.**

## General Precautions

**Read All Instructions** — Before you use the product, read all operating instructions. Save all manuals and documentation for future reference.

**Cleaning** — Always unplug this product from the wall outlet before cleaning. Use only a damp cloth for cleaning. Never use any type of liquid or aerosol cleaner, or any type of organic solvent to clean this product.

**Attachments** — For your safety, and to avoid damaging the product, use only accessories recommended by Olympus.

**Water and Moisture** — For precautions on products with weatherproof designs, read the weatherproofing sections.

**Location** — To avoid damage to the product, mount the product securely on a stable tripod, stand, or bracket.

**Power Source** — Connect this product only to the power source described on the product label.

**Foreign Objects** — To avoid personal injury, never insert a metal object into the product.

**Heat** — Never use or store this product near any heat source such as a radiator, heat register, stove, or any type of equipment or appliance that generates heat, including stereo amplifiers.

## Handling the Camera

### WARNING

- **Do not use the camera near flammable or explosive gases.**
- **Do not use the flash and LED on people (infants, small children, etc.) at close range.**
  - You must be at least 1 m (3 ft.) away from the faces of your subjects. Firing the flash too close to the subject's eyes could cause a momentary loss of vision.
- **Keep young children and infants away from the camera.**
  - Always use and store the camera out of the reach of young children and infants to prevent the following dangerous situations which could cause serious injury:
    - Becoming entangled in the camera strap, causing strangulation.
    - Accidentally swallowing the battery, cards or other small parts.
    - Accidentally firing the flash into their own eyes or those of another child.
    - Accidentally being injured by the moving parts of the camera.
- **Do not look at the sun or strong lights with the camera.**
- **Do not use or store the camera in dusty or humid places.**
- **Do not cover the flash with a hand while firing.**
- **Do not insert anything into the microSD Attachment other than the microSD card.**  
Other types of cards cannot be inserted into microSD Attachment.
- **Do not insert anything other than an xD-Picture Card or the microSD Attachment into the camera.**

If you insert a card by mistake, such as a microSD card, do not use force. Contact authorized distributors/service centers.

### CAUTION

- **Stop using the camera immediately if you notice any unusual odors, noise, or smoke around it.**
  - Never remove the batteries with bare hands, which may cause a fire or burn your hands.
- **Never hold or operate the camera with wet hands.**
- **Do not leave the camera in places where it may be subject to extremely high temperatures.**
  - Doing so may cause parts to deteriorate and, in some circumstances, cause the camera to catch fire. Do not use the charger if it is covered (such as a blanket). This could cause overheating, resulting in fire.
- **Handle the camera with care to avoid getting a low-temperature burn.**
  - When the camera contains metal parts, overheating can result in a low-temperature burn. Pay attention to the following:
    - When used for a long period, the camera will get hot. If you hold on to the camera in this state, a low-temperature burn may be caused.
    - In places subject to extremely cold temperatures, the temperature of the camera's body may be lower than the environmental temperature. If possible, wear gloves when handling the camera in cold temperatures.
- **Be careful with the strap.**
  - Be careful with the strap when you carry the camera. It could easily catch on stray objects and cause serious damage.

## Battery Handling Precautions

**Follow these important guidelines to prevent batteries from leaking, overheating, burning, exploding, or causing electrical shocks or burns.**

### DANGER

- The camera uses a lithium ion battery specified by Olympus. Charge the battery with the specified charger. Do not use any other chargers.
- Never heat or incinerate batteries.
- Take precautions when carrying or storing batteries to prevent them from coming into contact with any metal objects such as jewelry, pins, fasteners, etc.
- Never store batteries where they will be exposed to direct sunlight, or subjected to high temperatures in a hot vehicle, near a heat source, etc.
- To prevent causing battery leaks or damaging their terminals, carefully follow all instructions regarding the use of batteries. Never attempt to disassemble a battery or modify it in any way, solder, etc.
- If battery fluid gets into your eyes, flush your eyes immediately with clear, cold running water and seek medical attention immediately.
- Always store batteries out of the reach of small children. If a child accidentally swallows a battery, seek medical attention immediately.

### WARNING

- Keep batteries dry at all times.
- To prevent batteries from leaking, overheating, or causing a fire or explosion, use only batteries recommended for use with this product.
- Insert the battery carefully as described in the operating instructions.
- If rechargeable batteries have not been recharged within the specified time, stop charging them and do not use them.
- Do not use a battery if it is cracked or broken.
- If a battery leaks, becomes discolored or deformed, or becomes abnormal in any other way during operation, stop using the camera.
- If a battery leaks fluid onto your clothing or skin, remove the clothing and flush the affected area with clean, running cold water immediately. If the fluid burns your skin, seek medical attention immediately.
- Never subject batteries to strong shocks or continuous vibration.

### CAUTION

- Before loading, always inspect the battery carefully for leaks, discoloration, warping, or any other abnormality.
- The battery may become hot during prolonged use. To avoid minor burns, do not remove it immediately after using the camera.
- Always unload the battery from the camera before storing the camera for a long period.

## Caution for Usage Environment

- To protect the high-precision technology contained in this product, never leave the camera in the places listed below, no matter if in use or storage:
  - Places where temperatures and/or humidity are high or go through extreme changes. Direct sunlight, beaches, locked cars, or near other heat sources (stove, radiator, etc.) or humidifiers.
  - In sandy or dusty environments.
  - Near flammable items or explosives.
  - In wet places, such as bathrooms or in the rain. When using products with weatherproof designs, read their manuals as well.
  - In places prone to strong vibrations.
- Never drop the camera or subject it to severe shocks or vibrations.
- When mounted on a tripod, adjust the position of the camera with the tripod head. Do not twist the camera.
- Do not touch electric contacts on cameras.
- Do not leave the camera pointed directly at the sun. This may cause lens or shutter curtain damage, color failure, ghosting on the CCD, or may possibly cause fires.
- Do not push or pull severely on the lens.
- Before storing the camera for a long period, remove the batteries. Select a cool, dry location for storage to prevent condensation or mold from forming inside the camera. After storage, test the camera by turning it on and pressing the shutter button to make sure that it is operating normally.
- Always observe the operating environment restrictions described in the camera's manual.

## Battery Handling Precautions

- This camera uses a lithium ion battery specified by Olympus. Do not use any other type of battery.
- If the battery's terminals get wet or greasy, camera contact failure may result. Wipe the battery well with a dry cloth before use.
- Always charge a battery when using it for the first time, or if it has not been used for a long period.
- When operating the camera with battery power at low temperatures, try to keep the camera and spare battery as warm as possible. A battery that has run down at low temperatures may be restored after it is warmed at room temperature.
- The number of pictures you can take may vary depending on the shooting conditions or battery.
- Before going on a long trip, and especially before traveling abroad, purchase extra batteries. A recommended battery may be difficult to obtain while traveling.
- Please recycle batteries to help save our planet's resources. When you throw away dead batteries, be sure to cover their terminals and always observe local laws and regulations.

## LCD Monitor

- Do not push the monitor forcibly; otherwise the image may become vague, resulting in a playback mode failure or damage to the monitor.
- A strip of light may appear on the top/bottom of the monitor, but this is not a malfunction.
- When a subject is viewed diagonally in the camera, the edges may appear zigzagged on the monitor. This is not a malfunction; it will be less noticeable in playback mode.
- In places subject to low temperatures, the LCD monitor may take a long time to turn on or its color may change temporarily. When using the camera in extremely cold places, it is a good idea to occasionally place it in a warm place. An LCD monitor exhibiting poor performance due to low temperatures will recover in normal temperatures.
- The LCD used for the monitor is made with high-precision technology. However, black spots or bright spots of light may appear constantly on the LCD Monitor. Due to its characteristics or the angle at which you are viewing the monitor, the spot may not be uniform in color and brightness. This is not a malfunction.

## Legal and Other Notices

- Olympus makes no representations or warranties regarding any damages, or benefit expected by using this unit lawfully, or any request from a third person, which are caused by the inappropriate use of this product.
- Olympus makes no representations or warranties regarding any damages or any benefit expected by using this unit lawfully which are caused by erasing picture data.

## Disclaimer of Warranty

- Olympus makes no representations or warranties, either expressed or implied, by or concerning any content of these written materials or software, and in no event shall be liable for any implied warranty of merchantability or fitness for any particular purpose or for any consequential, incidental or indirect damages (including but not limited to damages for loss of business profits, business interruption and loss of business information) arising from the use or inability to use these written materials or software or equipment. Some countries do not allow the exclusion or limitation of liability for consequential or incidental damages or of the implied warranty, so the above limitations may not apply to you.
- Olympus reserves all rights to this manual.

## Warning

Unauthorized photographing or use of copyrighted material may violate applicable copyright laws. Olympus assumes no responsibility for unauthorized photographing, use or other acts that infringe upon the rights of copyright owners.

## Copyright Notice

All rights reserved. No part of these written materials or this software may be reproduced or used in any form or by any means, electronic or mechanical, including photocopying and recording or the use of any type of information storage and retrieval system, without the prior written permission of Olympus. No liability is assumed with respect to the use of the information contained in these written materials or software, or for damages resulting from the use of the information contained therein. Olympus reserves the right to alter the features and contents of this publication or software without obligation or advance notice.

## FCC Notice

- Radio and Television Interference
- Changes or modifications not expressly approved by the manufacturer may void the user's authority to operate this equipment. This equipment has been tested and found to comply with the limits for a Class B digital device, pursuant to Part 15 of the FCC Rules. These limits are designed to provide reasonable protection against harmful interference in a residential installation.
- This equipment generates, uses, and can radiate radio frequency energy and, if not installed and used in accordance with the instructions, may cause harmful interference to radio communications.
- However, there is no guarantee that interference will not occur in a particular installation. If this equipment does cause harmful interference to radio or television reception, which can be determined by turning the equipment off and on, the user is encouraged to try to correct the interference by one or more of the following measures:
  - Adjust or relocate the receiving antenna.
  - Increase the distance between the camera and receiver.
  - Connect the equipment to an outlet on a circuit different from that to which the receiver is connected.
  - Consult your dealer or an experienced radio/TV technician for help. Only the OLYMPUS-supplied USB cable should be used to connect the camera to USB enabled personal computers (PC).

Any unauthorized changes or modifications to this equipment would void the user's authority to operate it.

## Use Only Dedicated Rechargeable Battery and Battery Charger

We strongly recommend that you use only the genuine Olympus dedicated rechargeable battery and battery charger with this camera. Using a non-genuine rechargeable battery and/or battery charger may result in fire or personal injury due to leakage, heating, ignition or damage to the battery. Olympus does not assume any liability for accidents or damage that may result from the use of a battery and/or battery charger that are not genuine Olympus accessories.

## Representative plug of power supply cord of countries/regions around the world



A Type  
(American Type)



B Type  
(British Type)



BF Type  
(British Type)



B3 Type  
(British Type)



C Type  
(CEE Type)



SE Type  
(CEE Type)



O Type  
(Oceania Type)

The representative supply voltage and plug type are described in this chart.  
Depending on the area, different types of plugs and supply voltages are used.

Attention: Power cord meeting demands from each country shall be used.

- For only the United States

Use a UL Listed, 1.8 - 3 m (6 - 10 ft), Type SPT-2 or NISPT-2, AWG no. 18 power supply cord, rated for 125 V 7 A, with a non-polarized NEMA 1-15P plug rated for 125 V 15 A\*.

### Europe

Countries/Regions	Voltage	Frequency (Hz)	Plug type
Austria	230	50	C
Belgium	230	50	C
Czech	220	50	C
Denmark	230	50	C
Finland	230	50	C
France	230	50	C
Germany	230	50	C
Greece	220	50	C
Hungary	220	50	C
Iceland	230	50	C
Ireland	230	50	C/BF
Italy	220	50	C
Luxemburg	230	50	C
Netherlands	230	50	C
Norway	230	50	C
Poland	220	50	C
Portugal	230	50	C
Romania	220	50	C
Russia	220	50	C
Slovak	220	50	C
Spain	127/230	50	C
Sweden	230	50	C
Switzerland	230	50	C
UK	240	50	BF

### Asia

Countries/Regions	Voltage	Frequency (Hz)	Plug type
China	220	50	A
Hong Kong	200/220	50	BF
India	230/240	50	C
Indonesia	127/230	50	C
Japan	100	50/60	A
Korea (rep)	220	60	C
Malaysia	240	50	BF
Philippines	220/230	60	A/C
Singapore	230	50	BF
Taiwan	110	60	A
Thailand	220	50	C/BF
Vietnam	220	50	A/C

### Oceania

Countries/Regions	Voltage	Frequency (Hz)	Plug type
Australia	240	50	O
New Zealand	230/240	50	O

### North America

Countries/Regions	Voltage	Frequency (Hz)	Plug type
Canada	120	60	A
USA	120	60	A

### Central America

Countries/Regions	Voltage	Frequency (Hz)	Plug type
Bahamas	120/240	60	A
Costa Rica	110	60	A
Cuba	110/220	60	A/C
Dominican (rep)	110	60	A
El Salvador	110	60	A
Guatemala	120	60	A
Honduras	110	60	A
Jamaica	110	50	A
Mexico	120/127	60	A
Nicaragua	120/240	60	A
Panama	110/220	60	A

### South America

Countries/Regions	Voltage	Frequency (Hz)	Plug type
Argentina	220	50	C/BF/O
Brazil	127/220	60	A/C
Chile	220	50	C
Colombia	120	60	A
Peru	220	60	A/C
Venezuela	120	60	A

### Middle East

Countries/Regions	Voltage	Frequency (Hz)	Plug type
Iran	220	50	C/BF
Iraq	220	50	C/BF
Israel	230	50	C
Saudi Arabia	127/220	50	A/C/BF
Turkey	220	50	C
UAE	240	50	C/BF

### Africa

Countries/Regions	Voltage	Frequency (Hz)	Plug type
Algeria	127/220	50	C
Congo (dem)	220	50	C
Egypt	220	50	C
Ethiopia	220	50	C
Kenya	240	50	C/BF
Nigeria	230	50	C/BF
South Africa	220/230	50	C/BF
Tanzania	230	50	C/BF
Tunisia	220	50	C

## For customers in North and South America

### For customers in USA

Declaration of Conformity

Model Number : FE-5020/X-935

FE-4010/X-930

Trade Name : OLYMPUS

Responsible Party :

OLYMPUS IMAGING AMERICA INC.

Address : 3500 Corporate  
Parkway, P.O. Box  
610, Center Valley, PA  
18034-0610, U.S.A.

Telephone Number : 484-896-5000

Tested To Comply With FCC Standards  
FOR HOME OR OFFICE USE

This device complies with Part 15 of the FCC rules.  
Operation is subject to the following two conditions:

- (1) This device may not cause harmful interference.
- (2) This device must accept any interference received, including interference that may cause undesired operation.

### For customers in Canada

This Class B digital apparatus meets all requirements of the Canadian Interference-Causing Equipment Regulations.

## OLYMPUS WORLDWIDE LIMITED WARRANTY - IMAGING PRODUCTS

Olympus warrants that the enclosed Olympus® imaging product(s) and related Olympus® accessories (individually a "Product" and collectively the "Products") will be free from defects in materials and workmanship under normal use and service for a period of one (1) year from the date of purchase.

If any Product proves to be defective within the one-year warranty period, the customer must return the defective Product to any of Olympus Service Centers, following the procedure set forth below (See "WHAT TO DO WHEN SERVICE IS NEEDED").

Olympus, at its sole discretion, will repair, replace, or adjust the defective Product, provided that Olympus investigation and factory inspection disclose that (a) such defect developed under normal and proper use and (b) the Product is covered under this limited warranty. Repair, replacement, or adjustment of defective Products shall be Olympus's sole obligation and the customer's sole remedy hereunder.

The customer is liable and shall pay for shipment of the Products to the Olympus Service Center.

Olympus shall not be obligated to perform preventive maintenance, installation, deinstallation, or maintenance.

Olympus reserves the right to (i) use reconditioned, refurbished, and/or serviceable used parts (that meet Olympus's quality assurance standards) for warranty or any other repairs and (ii) make any internal or external design and/or feature changes on or to its products without any liability to incorporate such changes on or to the Products.

## WHAT IS NOT COVERED BY THIS LIMITED WARRANTY

Excluded from this limited warranty and not warranted by Olympus in any fashion, either express, implied, or by statute, are:

- (a) products and accessories not manufactured by Olympus and/or not bearing the "OLYMPUS" brand label (the warranty coverage for products and accessories of other manufacturers, which may be distributed by Olympus, is the responsibility of the manufacturers of such products and accessories in accordance with the terms and duration of such manufacturers' warranties);
- (b) any Product which has been disassembled, repaired, tampered with, altered, changed, or modified by persons other than Olympus's own authorized service personnel unless repair by others is made with the written consent of Olympus;
- (c) defects or damage to the Products resulting from wear, tear, misuse, abuse, negligence, sand, liquids, impact, improper storage, nonperformance of scheduled operator and maintenance items, battery leakage, use of non-"OLYMPUS" brand accessories, consumables, or supplies, or use of the Products in combination with non-compatible devices;
- (d) software programs;
- (e) supplies and consumables (including but not limited to lamps, ink, paper, film, prints, negatives, cables and batteries); and/or
- (f) Products which do not contain a validly placed and recorded Olympus serial number, unless they are a model on which Olympus does not place and record serial numbers.

EXCEPT FOR THE LIMITED WARRANTY SET FORTH ABOVE, OLYMPUS MAKES NO AND DISCLAIMS ALL OTHER REPRESENTATIONS, GUARANTIES, CONDITIONS, AND WARRANTIES CONCERNING THE PRODUCTS, WHETHER DIRECT OR INDIRECT, EXPRESS OR IMPLIED, OR ARISING UNDER ANY STATUTE, ORDINANCE, COMMERCIAL USAGE OR OTHERWISE, INCLUDING BUT NOT LIMITED TO ANY WARRANTY OR REPRESENTATION AS TO THE SUITABILITY,

DURABILITY, DESIGN, OPERATION, OR CONDITION OF THE PRODUCTS (OR ANY PART THEREOF) OR THE MERCHANTABILITY OF THE PRODUCTS OR THEIR FITNESS FOR A PARTICULAR PURPOSE, OR RELATING TO THE INFRINGEMENT OF ANY PATENT, COPYRIGHT, OR OTHER PROPRIETARY RIGHT USED OR INCLUDED THEREIN. IF ANY IMPLIED WARRANTIES APPLY AS A MATTER OF LAW, THEY ARE LIMITED IN DURATION TO THE LENGTH OF THIS LIMITED WARRANTY. SOME STATES MAY NOT RECOGNIZE A DISCLAIMER OR LIMITATION OF WARRANTIES AND/OR LIMITATION OF LIABILITY SO THE ABOVE DISCLAIMERS AND EXCLUSIONS MAY NOT APPLY. THE CUSTOMER MAY ALSO HAVE DIFFERENT AND/OR ADDITIONAL RIGHTS AND REMEDIES THAT VARY FROM STATE TO STATE. THE CUSTOMER ACKNOWLEDGES AND AGREES THAT OLYMPUS SHALL NOT BE RESPONSIBLE FOR ANY DAMAGES THAT THE CUSTOMER MAY INCUR FROM DELAYED SHIPMENT, PRODUCT FAILURE, PRODUCT DESIGN, SELECTION, OR PRODUCTION, IMAGE OR DATA LOSS OR IMPAIRMENT OR FROM ANY OTHER CAUSE, WHETHER LIABILITY IS ASSERTED IN CONTRACT, TORT (INCLUDING NEGLIGENCE AND STRICT PRODUCT LIABILITY) OR OTHERWISE. IN NO EVENT SHALL OLYMPUS BE LIABLE FOR ANY INDIRECT, INCIDENTAL, CONSEQUENTIAL OR SPECIAL DAMAGES OF ANY KIND (INCLUDING WITHOUT LIMITATION LOSS OF PROFITS OR LOSS OF USE), WHETHER OR NOT OLYMPUS SHALL BE OR SHOULD BE AWARE OF THE POSSIBILITY OF SUCH POTENTIAL LOSS OR DAMAGE.

Representations and warranties made by any person, including but not limited to dealers, representatives, salespersons, or agents of Olympus, which are inconsistent or in conflict with or in addition to the terms of this limited warranty, shall not be binding upon Olympus unless reduced to writing and approved by an expressly authorized officer of Olympus. This limited warranty is the complete and exclusive statement of warranty which Olympus agrees to provide with respect to the Products and it shall supersede all prior and contemporaneous oral or written agreements, understandings, proposals, and communications pertaining to the subject matter hereof. This limited warranty is exclusively for the benefit of the original customer and cannot be

transferred or assigned.

#### **WHAT TO DO WHEN SERVICE IS NEEDED**

The customer must transfer any image or other data saved on a Product to another image or data storage medium and/or remove any film from the Product prior to sending the Product to Olympus for service.

IN NO EVENT SHALL OLYMPUS BE RESPONSIBLE FOR SAVING, KEEPING OR MAINTAINING ANY IMAGE OR DATA SAVED ON A PRODUCT RECEIVED BY IT FOR SERVICE, OR ON ANY FILM CONTAINED WITHIN A PRODUCT RECEIVED BY IT FOR SERVICE, NOR SHALL OLYMPUS BE RESPONSIBLE FOR ANY DAMAGES IN THE EVENT ANY IMAGE OR DATA IS LOST OR IMPAIRED WHILE SERVICE IS BEING PERFORMED (INCLUDING, WITHOUT LIMITATION, DIRECT, INDIRECT, INCIDENTAL, CONSEQUENTIAL OR SPECIAL DAMAGES, LOSS OF PROFITS OR LOSS OF USE), WHETHER OR NOT OLYMPUS SHALL BE OR SHOULD BE AWARE OF THE POSSIBILITY OF SUCH POTENTIAL LOSS OR IMPAIRMENT.

Package the Product carefully using ample padding material to prevent damage in transit and either deliver it to the Authorized Olympus Dealer that sold you the Product or ship it postage prepaid and insured to any of our Olympus Service Centers.

When returning Products for service, your package should include the following:

- 1 Sales receipt showing date and place of purchase.
- 2 Copy of this limited warranty **bearing the Product serial number corresponding to the serial number on the Product** (unless it is a model on which Olympus does not place and record serial numbers).
- 3 A detailed description of the problem.
- 4 Sample prints, negatives, digital prints (or files on disk) if available and related to the problem.

When service is completed, the Product will be returned to you postage prepaid.

#### **WHERE TO SEND PRODUCT FOR SERVICE**

See "WORLDWIDE WARRANTY" for the nearest service center.

#### **INTERNATIONAL WARRANTY SERVICE**

International warranty service is available under this warranty.



## For customers in Europe



"CE" mark indicates that this product complies with the European requirements for safety, health, environment and customer protection. "CE" mark cameras are intended for sales in Europe.



This symbol [crossed-out wheeled bin WEEE Annex IV] indicates separate collection of waste electrical and electronic equipment in the EU countries.

Please do not throw the equipment into the domestic refuse.

Please use the return and collection systems available in your country for the disposal of this product.



This symbol [crossed-out wheeled bin Directive 2006/66/EC Annex II] indicates separate collection of waste batteries in the EU countries. Please do not throw the batteries into the domestic refuse. Please use the return and collection systems available in your country for the disposal of the waste batteries.

### Provisions of warranty

- 1 If this product proves to be defective, although it has been used properly (in accordance with the written Handling Care and Operating instructions supplied with it), during the applicable national warranty period and has been purchased from an authorized Olympus distributor within the business area of Olympus Imaging Europa GmbH as stipulated on the website: <http://www.olympus.com> this product will be repaired, or at Olympus's option replaced, free of charge. To claim under this warranty the customer must take the product before the end of the applicable national warranty period to the dealer where the product was purchased or any other Olympus service station within the business area of Olympus Imaging Europa GmbH as stipulated on the website: <http://www.olympus.com>. During the one year period of the World Wide Guarantee the customer may turn the product in at any Olympus service station. Please notice that not in all countries such Olympus service station exists.
- 2 The customer shall transport the product to the dealer or Olympus authorized service station at his own risk and shall be responsible for any costs incurred in transporting the product.

### Provisions of Guarantee

- 1 "OLYMPUS IMAGING CORP., Shinjuku Monolith, 2-3-1 Nishi-Shinjuku, Shinjuku-ku, Tokyo 163-0914, Japan grants a one year World Wide Guarantee. This worldwide Guarantee must be presented at an Olympus authorized repair service station before any repair can be made under conditions of this Guarantee. This Guarantee is valid only if the Guarantee Certificate and proof of purchase are presented at the Olympus repair service station. Please note that this Guarantee is in addition to and does not

affect the customer's legal warranty rights under the applicable national legislation governing the sale of consumer goods mentioned above.

- 2 This Guarantee does not cover the following and the customer will be required to pay repair charge, even for defects occurring within the Guarantee period referred to above.
  - a. Any defect that occurs due to mishandling (such as an operation performed that is not mentioned in the Handling Care or other sections of the instructions, etc.)
  - b. Any defect that occurs due to repair, modification, cleaning, etc. performed by anyone other than Olympus or an Olympus authorized service station.
  - c. Any defect or damage that occurs due to transport, a fall, shock, etc. after purchase of the product.
  - d. Any defect or damage that occurs due to fire, earthquake, flood damage, thunderbolt, other natural disasters, environmental pollution and irregular voltage sources.
  - e. Any defect that occurs due to careless or improper storage (such as keeping the product under conditions of high temperature and humidity, near insect repellents such as naphthalene or harmful drugs, etc.), improper maintenance, etc.
  - f. Any defect that occurs due to exhausted batteries, etc.
  - g. Any defect that occurs due to sand, mud, etc. entering the inside of the product casing.
  - h. When the Guarantee Certificate is not returned with the product.
  - i. When any alterations whatsoever are made to the Guarantee Certificate regarding the year, month and date of purchase, the customer's name, the dealer's name, and the serial number.
  - j. When proof of purchase is not presented with this Guarantee Certificate.
- 3 This Guarantee applies to the product only; the Guarantee does not apply to any other accessory equipment, such as the case, strap, lens cap and batteries.
- 4 Olympus's sole liability under this Guarantee shall be limited to repairing or replacing the product. Any liability under the Guarantee for indirect or consequential loss or damage of any kind incurred or suffered by the customer due to a defect of the product, and in particular any loss or damage caused to any lenses, films, other equipment or accessories used with the product or for any loss resulting from a delay in repair or loss of data, is excluded. Compelling regulations by law remain unaffected by this.

## Notes regarding Guarantee maintenance

- 1 This Guarantee will only be valid if the Guarantee Certificate is duly completed by Olympus or an authorized dealer or other documents contain sufficient proof. Therefore, please make sure that your name, the name of the dealer, the serial number and the year, month and date of purchase are all completed or the original invoice or the sales receipt (indicating the dealer's name, the date of purchase and product type) is attached to this Guarantee Certificate. Olympus reserves the right to refuse free-of-charge service if neither Guarantee Certificate is completed nor the above document is attached or if the information contained in it is incomplete or illegible.
  - 2 Since this Guarantee Certificate will not be re-issued, keep it in a safe place.
- \* Please refer to the list on the web site: <http://www.olympus.com> for the authorized international Olympus service network.

## Trademarks

- IBM is a registered trademark of International Business Machines Corporation.
- Microsoft and Windows are registered trademarks of Microsoft Corporation.
- Macintosh is a trademark of Apple Inc.
- xD-Picture Card™ is a trademark.
- microSD is a trademark of the SD Association.
- All other company and product names are registered trademarks and/or trademarks of their respective owners.
- The standards for camera file systems referred to in this manual are the "Design rule for Camera File system/DCF" standards stipulated by the Japan Electronics and Information Technology Industries Association (JEITA).

## SPECIFICATIONS

### Camera

<b>Product type</b>	: Digital camera (for shooting and displaying)
<b>Recording system</b>	
<b>Still pictures</b>	: Digital recording, JPEG (in accordance with Design rule for Camera File system (DCF))
<b>Applicable standards</b>	: Exif 2.2, Digital Print Order Format (DPOF), PRINT Image Matching III, PictBridge
<b>Sound with still pictures</b>	: Wave format
<b>Movie</b>	: AVI Motion JPEG
<b>Memory</b>	: Internal memory xD-Picture Card (16 MB to 2 GB) (TypeH/M/M+, Standard) microSD card/microSDHC card (when the supplied microSD Attachment is used.)
<b>No. of effective pixels</b>	: 12,000,000 pixels
<b>Image pickup device</b>	: 1/2.3" CCD (primary color filter), 12,200,000 pixels (gross)
<b>Lens</b>	: FE-5020/X-935: Olympus lens 4.3 to 21.5 mm, f3.3 to 5.8 (equivalent to 24 to 120 mm on a 35 mm camera) FE-4010/X-930: Olympus lens 4.65 to 18.6 mm, f2.6 to 5.9 (equivalent to 26.3 to 105 mm on a 35 mm camera)
<b>Photometric system</b>	: Digital ESP metering system
<b>Shutter speed</b>	: FE-5020/X-935: 4 to 1/1500 sec. FE-4010/X-930: 4 to 1/2000 sec.
<b>Shooting range</b>	: FE-5020/X-935: 0.6 m (2.0 ft.) to ∞ (W), 1.0 m (3.3 ft.) to ∞ (T) (normal) 0.15 m (0.5 ft.) to ∞ (W), 0.6 m (2.0 ft.) to ∞ (T) (macro mode) 0.1 m (0.3 ft.) to ∞ (super macro mode) FE-4010/X-930: 0.6 m (2.0 ft.) to ∞ (W), 1.0 m (3.3 ft.) to ∞ (T) (normal) 0.15 m (0.5 ft.) to ∞ (W), 0.6 m (2.0 ft.) to ∞ (T) (macro mode) 0.04 m (0.1 ft.) to ∞ (super macro mode)
<b>Monitor</b>	: 2.7" TFT color LCD display, 230,000 dots
<b>Connector</b>	: Multi-connector (USB connector, A/V OUT jack)
<b>Automatic calendar system</b>	: 2000 up to 2099
<b>Operating environment</b>	
<b>Temperature</b>	: 0 °C to 40 °C (32 °F to 104 °F) (operation) / -20 °C to 60 °C (-4 °F to 140 °F) (storage)
<b>Humidity</b>	: 30 % to 90 % (operation)/10 % to 90 % (storage)
<b>Power supply</b>	: One Olympus lithium ion battery (LI-42B / LI-40B)
<b>Dimensions</b>	: FE-5020/X-935: 92.7 mm (W) × 55.8 mm (H) × 24.7 mm (D) (3.6 × 2.2 × 1.0 in.) (excluding protrusions) FE-4010/X-930: 93.3 mm (W) × 55.6 mm (H) × 22.1 mm (D) (3.7 × 2.2 × 0.9 in.) (excluding protrusions)
<b>Weight</b>	: FE-5020/X-935: 107 g (3.7 oz) (excluding battery and card) FE-4010/X-930: 101 g (3.5 oz) (excluding battery and card)

## Lithium ion battery (LI-42B)

<b>Product type</b>	: Lithium ion rechargeable battery
<b>Standard voltage</b>	: DC 3.7 V
<b>Standard capacity</b>	: 740 mAh
<b>Battery life</b>	: Approx. 300 full charges (varies on usage)
<b>Operating environment</b>	
<b>Temperature</b>	: 0°C to 40°C (32°F to 104°F) (charging) / -10°C to 60°C (14°F to 140°F) (operation) / -20°C to 35°C (-4°F to 95°F) (storage)
<b>Dimensions</b>	: 31.5 mm (W) × 39.5 mm (H) × 6.0 mm (D) (1.2 × 1.5 × 0.2 in.)
<b>Weight</b>	: Approx. 15 g (0.5 oz)

## Battery charger (LI-41C)

<b>Model No.</b>	: LI-41CAA/LI-41CAB/LI-41CBA/LI-41CBB
<b>Power requirements</b>	: AC 100 to 240 V (50/60 Hz)
<b>Output</b>	: DC 4.2 V, 600 mA
<b>Charging time</b>	: Approx. 2 hours (When charging the supplied LI-42B)
<b>Operating environment</b>	
<b>Temperature</b>	: 0 °C to 40 °C (32 °F to 104 °F) (operation) / -20 °C to 60 °C (-4 °F to 140 °F) (storage)
<b>Dimensions</b>	: 62.0 mm (W) × 23.5 mm (H) × 90.0 mm (D) (2.4 × 0.9 × 3.5 in.)
<b>Weight</b>	: Approx. 65 g (2.3 oz)

## microSD Attachment

<b>Product type</b>	: Attachment for microSD card
<b>Operating environment</b>	
<b>Temperature</b>	: -10 °C to 40 °C (14 °F to 104 °F) (operation) / -20 °C to 65 °C (-4 °F to 149 °F) (storage)
<b>Humidity</b>	: 95 % and below (operation) / 85 % and below (storage)
<b>Dimensions</b>	: 25.0 mm (W) × 20.3 mm (H) × 1.7 mm (D) (1.0 × 0.8 × 0.07 in.) (Handle:2.2 mm (0.09 in.))
<b>Weight</b>	: Approx. 0.9 g (0.03 oz)

Design and specifications subject to change without notice.

## A

AF MODE .....	26
AF TRACKING .....	18, 26
Arrow pad .....	12
AV cable .....	34



## B

Backlight boost .....	21
BACKUP .....	31
Battery charger .....	10, 46
Beep .....	33
Brightness	
Backlight boost .....	21
Exposure compensation .....	20
Monitor brightness  .....	33



## C

Card	
microSD Card .....	12, 49
microSDHC card .....	12, 49
xD-Picture Card .....	11, 47
Compression .....	23
Connecting	
PC .....	40
Printer .....	35
TV .....	34
CUSTOM PRINT .....	36

## D

Date and time  .....	13, 33
DIS MODE  .....	18
DIS MOVIE MODE .....	25
Display language  .....	13, 31

## E

EASY PRINT .....	35
Edit (still images)	
Cropping  .....	28
INDEX .....	29
Resize  .....	28

## ERASE

ALL ERASE .....	30
SEL. IMAGE .....	30
Single image erase .....	16
Error message .....	43

## F

FACE DETECT .....	26
FINE ZOOM .....	25
Flash	
FILL IN .....	19
FLASH AUTO .....	19
FLASH OFF .....	19
REDEYE .....	19
FORMAT .....	31
Frame rate .....	23
FUNC menu .....	21



## I













iAUTO mode .....	17
iESP .....	26
IMAGE QUALITY  .....	23
Image size .....	23
Information display .....	21, 22
Internal memory .....	11, 47, 48
ISO sensitivity .....	24

## L

Lithium ion Battery .....	10, 46
---------------------------	--------

## M

Macro  .....	20
MAGIC FILTER  .....	27
Maintenance	
Camera care .....	46
PIXEL MAPPING .....	31
MEMORY FORMAT .....	31
MENU COLOR .....	32
microSD Attachment .....	12, 49

<b>N</b>		<b>T</b>	
Natural color .....	24	Turning on the camera.....	13
<b>O</b>		  .....	31
OLYMPUS Master 2 .....	40	<b>U</b>	
Operation guide .....	12	USB cable.....	35, 40
<b>P</b>		Using the Menu.....	3
PANORAMA.....	26	<b>V</b>	
PERFECT FIX  .....	28	VIDEO OUT .....	34
PictBridge .....	35	Volume.....	33
Playback image		<b>W</b>	
Close-up view .....	22	Warning sound  .....	33
Index view .....	22	WB .....	24
Movies .....	15	<b>Z</b>	
On TV .....	34	Zoom.....	19
Viewing images.....	15		
<b>P</b> mode.....	14		
PW ON SETUP.....	32		
POWER SAVE.....	34		
Print .....	35		
Print Reservations (DPOF) .....	38		
Protecting images  .....	29		
<b>R</b>			
RESET  .....	27		
Rotating images  .....	29		
<b>S</b>			
<b>SCN</b> mode .....	17		
Self-timer .....	21		
Shooting.....	14		
Shooting movies  .....	18		
SHUTTER SOUND.....	33		
SILENT MODE  .....	34		
SLIDESHOW  .....	28		
Sound recording  .....	25, 29		
SOUND SETTINGS.....	33		
SPOT .....	26		
Strap .....	10		
SUPER MACRO  .....	20		
SWITCH SHOOTING MODES  .....	27		



<http://www.olympus.com/>

### OLYMPUS IMAGING CORP.

Shinjuku Monolith, 3-1 Nishi-Shinjuku 2-chome, Shinjuku-ku, Tokyo, Japan

### OLYMPUS IMAGING AMERICA INC.

3500 Corporate Parkway, P.O. Box 610, Center Valley, PA 18034-0610, U.S.A. Tel. 484-896-5000

#### Technical Support (USA)

24/7 online automated help: <http://www.olympusamerica.com/support>

Phone customer support: Tel. 1-888-553-4448 (Toll-free)

Our phone customer support is available from 8 am to 10 pm

(Monday to Friday) ET

<http://olympusamerica.com/contactus>

Olympus software updates can be obtained at: <http://www.olympusamerica.com/digital>

### OLYMPUS IMAGING EUROPA GMBH

Premises: Wendenstrasse 14-18, 20097 Hamburg, Germany

Tel: +49 40-23 77 3-0 / Fax: +49 40-23 07 61

Goods delivery: Bredowstrasse 20, 22113 Hamburg, Germany

Letters: Postfach 10 49 08, 20034 Hamburg, Germany

#### European Technical Customer Support:

Please visit our homepage <http://www.olympus-europa.com>

or call our TOLL FREE NUMBER\* : **00800 - 67 10 83 00**

for Austria, Belgium, Denmark, Finland, France, Germany, Italy, Luxemburg, Netherlands, Norway, Portugal, Spain, Sweden, Switzerland, United Kingdom

\* Please note some (mobile) phone services providers do not permit access or request an additional prefix to +800 numbers.

For all European Countries not listed and in case that you can't get connected

to the above mentioned number, please make use of the following

CHARGED NUMBERS: **+49 180 5 - 67 10 83** or **+49 40 - 237 73 4899**

Our Technical Customer Support is available from 9 am to 6 pm MET (Monday to Friday)