

OLYMPUS[®]

DIGITAL CAMERA

SH-1

Instruction Manual

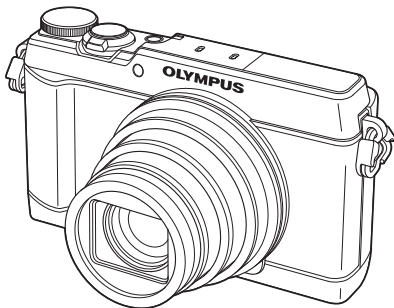

- Thank you for purchasing an Olympus digital camera. Before you start to use your new camera, please read these instructions carefully to enjoy optimum performance and a longer service life. Keep this manual in a safe place for future reference.
- We recommend that you take test shots to get accustomed to your camera before taking important photographs.
- The screen and camera illustrations shown in this manual were produced during the development stages and may differ from the actual product.

Unpack the box contents

The following items are included with the camera.

If anything is missing or damaged, contact the dealer from whom you purchased the camera.



Digital camera



Strap



Lithium Ion Battery
(LI-92B)



OLYMPUS Setup
CD-ROM



Stylus pen



or



USB-AC adapter (F-2AC)



USB cable (CB-USB8)

Other accessories not shown: Warranty card
Contents may vary depending on purchase location.

- The touch panel can be used for operations marked with  in this manual.

Attaching the camera strap

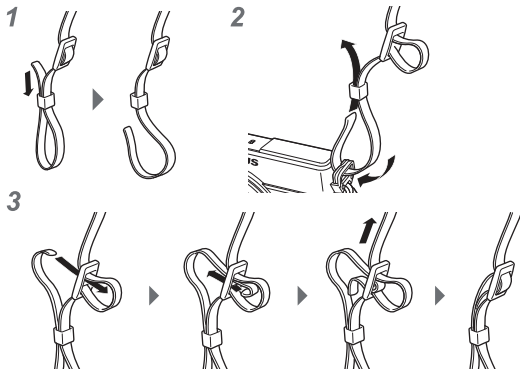

- Attach the strap to the other eyelet in the same manner.
- Pull the strap tight so that it does not come loose.

Names of parts

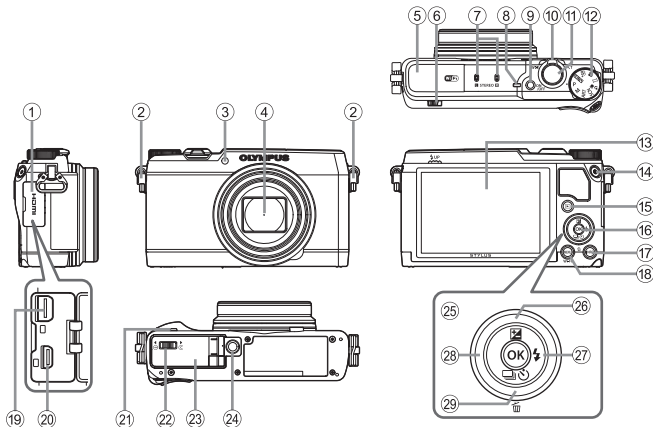

- ① Connector cover
 - ② Strap eyelet
 - ③ Self-timer lamp/AF illuminator
 - ④ Lens
 - ⑤ Built-in flash
 - ⑥ Flash switch
 - ⑦ Stereo microphone
 - ⑧ Indicator lamp
 - ⑨ **ON/OFF** button
 - ⑩ Zoom lever
 - ⑪ Shutter button
 - ⑫ Mode dial
 - ⑬ Monitor (Touch screen)
 - ⑭ **⏏** (Movie) button
 - ⑮ **▶** (Playback) button
 - ⑯ **OK** button
 - ⑰ **INFO** (Information display) button
 - ⑱ **MENU/Wi-Fi** button
 - ⑲ Multi-connector
 - ⑳ HDMI micro connector
 - ㉑ Speaker
 - ㉒ Battery/card compartment lock
 - ㉓ Battery/card compartment cover
 - ㉔ Tripod socket
 - ㉕ Arrow pad
 - ㉖ **△** (Up) / **⊠** (Exposure compensation) button
 - ㉗ **▷** (Right) / **⚡** (Flash) button
 - ㉘ **◁** (Left) button
 - ㉙ **▽** (Down) / **⏹** (Sequential shooting/Self-timer) / **🗑️** (Erase) button
- **△ ▽ ◁ ▷** instruct to press the up/down/left/right arrow pad.

Preparations for shooting

Inserting and removing the battery and card

- 1** Follow Steps ① and ② to open the battery/card compartment cover.

- Turn off the camera before opening the battery/card compartment cover.

Battery/card compartment lock

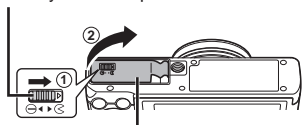

Battery/card compartment cover

- 2** Insert the battery while sliding the battery lock knob in the direction of the arrow.

- Insert the battery as illustrated with the  mark toward the battery lock knob.
- Slide the battery lock knob in the direction of the arrow to unlock, and then remove the battery.

Battery lock knob

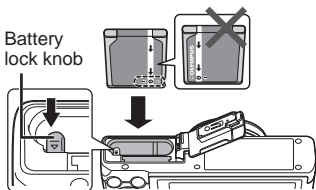

- 3** Insert the card straight until it clicks into place.

- Always use the specified cards with this camera. Do not insert other types of memory cards.  "Using the card" (P. 94)
- Do not touch the metallic parts of the card directly.

Write-protect switch

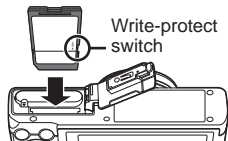

To remove the card

Press the card in until it clicks and comes out slightly, then remove the card.

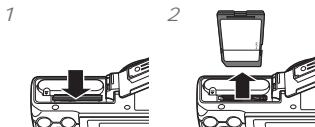

4 Follow Steps ① and ② to close battery/card compartment cover.

- When using the camera, be sure to close the battery/card compartment cover.

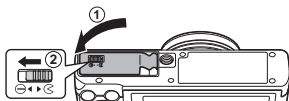

Charging the battery

1 Connect the USB cable and USB-AC adapter to the camera and charge the battery.

- The battery is not fully charged at shipment. Before use, be sure to charge the battery until the indicator lamp turns off (up to 4.5 hours).

Connecting the camera

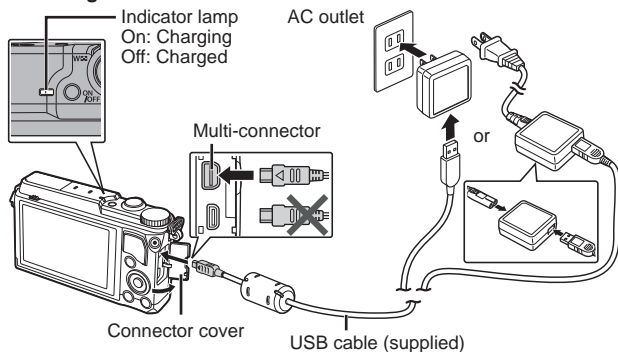

For charging the battery abroad, see "Using your charger and USB-AC adapter abroad" (P. 93).

- ⚠ Never use any cable other than supplied or Olympus-designated USB cable. This may cause smoking or burning.
- ⚠ The included F-2AC USB-AC adapter (hereafter referred to as USB-AC adapter) differs depending on the region where you purchased the camera. If you received a plug-in type USB-AC adapter, plug it directly into AC outlet.
- ⚠ Be sure to unplug the power plug of the USB-AC adapter from the wall outlet when the charging is complete or the playback ends.
- ⚠ For details on the battery, see "Battery Handling Precautions" (P. 102). For details on the USB-AC adapter, see "USB-AC adapter" (P. 103).

- If the indicator lamp does not light, check the USB cable and USB-AC adapter connections.
- If “No Connection” is displayed on the back monitor, disconnect the USB cable and set [Storage] in [USB Connection] (P. 63) before connecting the cable again.

When to charge the batteries

Charge the battery when the error message shown on the right appears.

Flashes in red



Error message

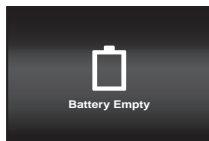

Turning on the camera and making the initial settings

When you turn on the camera for the first time, a screen appears enabling to set the language for the menus and messages displayed in the monitor, and the date and time.

To change the selected date and time, see “Setting the date and time f [⌚]” (P. 65).

- 1 Press the **ON/OFF** button to turn on the camera, press $\Delta \nabla \triangleleft \triangleright$ of the arrow pad to select your language and press the OK button.

- 2 Press $\Delta \nabla$ of the arrow pad to select the year for [Y].

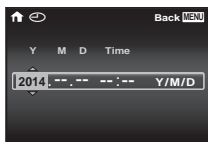

- 3 Press \triangleright of the arrow pad to save the setting for [Y].

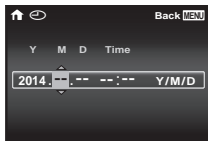

- 4 As in Steps 2 and 3, press $\Delta \nabla \triangleleft \triangleright$ of the arrow pad to set [M] (month), [D] (day), [Time] (hours and minutes), and [Y/M/D] (date order), and then press the OK button.

- For precise time setting, press the OK button as the time signal strikes 00 seconds.

5 Use ◀▶ to select the time zone and then press the **OK** button.

- Use ▲▼ to turn daylight saving time ([Summer]) on or off.

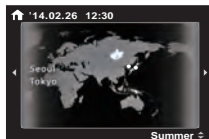

Using basic functions



Taking photographs

1 Press the **ON/OFF** button to turn on the camera.

When the camera is turned on, the monitor will turn on.

2 Set the mode dial to **P**.

In mode **P**, the camera automatically adjusts shutter speed and aperture in response to subject brightness.



3 Frame the shot.

- When holding the camera, take care not to cover the flash, microphone or other important parts with your fingers, etc.

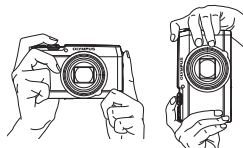

4 Press the shutter button halfway down to focus.

The camera was unable to focus if the AF target mark flashes red. Try focusing again.

- The shutter speed and aperture value are displayed in red if the camera is unable to achieve optimal exposure.

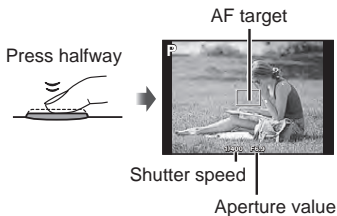

5 To take the picture, gently press the shutter button all the way down while being careful not to shake the camera.

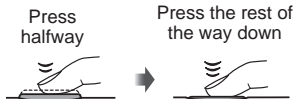

- You can also take photographs using the touch screen.



 "Shooting using touch panel" (P. 39)



Viewing photographs (Playing back images)

Turn on the camera.

Press the  button.

- Your most recent photograph is displayed.
- Press   to select an image.

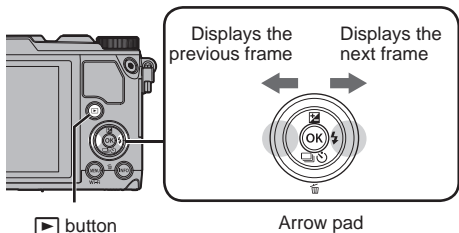



Still image

You can view later frames and earlier frames using the touch screen.

- Drag the screen to left to advance one frame, and drag the screen to right to rewind one frame.





Index display

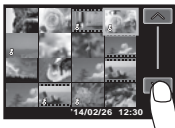



- In single-frame playback, turn the zoom lever to W for Index playback.
- Use    to move the cursor.
- Turn the zoom lever to T for single-frame playback.



Tap  to display Index playback.

- Tap   on the right to view the next or previous page.
- Tap an image to view it full frame.

Close-up playback

- In single-frame playback, turn the zoom lever to T to zoom in up to 10x; turn to W to zoom out. Press the  to return to single-frame playback.
- Press     to scroll an image to the direction of the button you pressed.



Tap  for playback zoom.

- Use your finger to scroll the display when the picture is zoomed in.
- Tap  to return to single-frame playback.

Recording movies

1 Press the  (movie) button to start recording.

- The movie is shot in the set shooting mode. Note that the shooting mode effects may not be obtained for some shooting modes.
- Sound is also recorded.
- When using a camera with a CMOS image sensor, moving objects may appear distorted due to the rolling shutter phenomenon.

This is a physical phenomenon whereby distortion occurs in the filmed image when shooting a fast-moving subject or due to camera shaking. In particular, this phenomenon becomes more noticeable when using a long focal length.

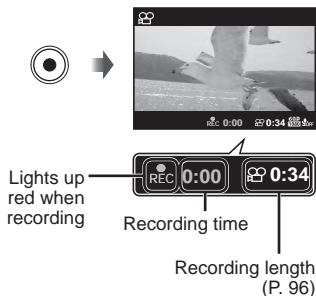

2 Press the  (movie) button again to stop recording.



Movie playback

Select a movie, and press the **OK** button.

- Turn the zoom lever to the T side to display the movie index. Use Δ ∇ \triangleleft \triangleright to select the frame to start playback.



Movie



During playback

Pausing and restarting playback	Press the OK button to pause playback. During pause, fast forward or reverse, press the OK button to restart playback.
Fast forward	Press \triangleright to fast forward. Press \triangleright again to increase the fast forward speed.
Rewind	Press \triangleleft to rewind. Press \triangleleft again to increase the rewind speed.
Adjusting the volume	Use Δ ∇ to adjust the volume.

Operations while playback is paused

Elapsed time/Total shooting time



During pause

Jump	Press Δ ∇ to jump to the previous/next index.
Advancing and rewinding one frame at a time	Press \triangleright or \triangleleft to advance or rewind one frame at a time. Hold \triangleright or \triangleleft pressed for continuous advance or rewind.
Resuming playback	Press the OK button to resume playback.

- During a pause, turn the zoom lever to the W side for the split index display.





To stop movie playback

Press the **MENU** button.

- To play back movies on the computer, the supplied PC software is recommended. For the first use of the PC software, connect the camera to the computer, then launch the software.

Playing back movies using touch panel

Tap the following icon.

	Play back movies. Tap again to pause playback.
	Tap << or >> to fast forward or rewind.
	Tap < or > to advance or rewind one frame.
	Go back to the beginning of the movie.
	Display movie index.

Erasing images during playback

1 Display the image you want to erase and press ▽ (🗑).

- To erase a movie, select the movie to erase and press ▽ (🗑).

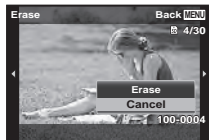

2 Press △ ▽ to select [Erase], and press the (OK) button.

- Grouped images are erased as a group (P. 16).
- Multiple images or all images can be erased at a time (P. 61).



Playing back panorama and grouped images

Playing back panorama images

Panorama images that were combined together using [Auto] or [Manual] can be scrolled for viewing.

- 1 Select a panorama image during playback.
- 2 Press the  button.







To control panorama image playback

Stop playback: Press the **MENU** button.

Pause: Press the  button.

Control while paused

Press     to scroll the image in the direction of the pressed button.

Turn the zoom lever to enlarge/shrink the image.

Press the  button to restart scrolling.







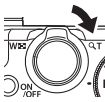

Viewing area

Tapping  also scrolls panorama images for viewing.

Playing back grouped images

With sequential shooting, interval shooting and Photo in Movie, the taken images are displayed as a group during playback.

<p>T side</p> 	<p>Expands.</p> <ul style="list-style-type: none">• Expand to view the frames of a group in index view.• Tapping  also expands the frames.• If you want to delete images from the grouped images, you can expand the group and delete the images individually.• Select the image and press the  button to display the images respectively.• Use  to view the previous/next frame.
<p> button</p>	<p>Plays back the grouped images in sequence automatically or pauses playback.</p>

Tapping  also plays back grouped images.

Sequential images frame

- The sequentially shot images are played back automatically.
- Expand to view the images in index view.



Sequential images frame

Photo in Movie frame

- The movie and the still images are played back.
- Expand to view the images in index view.
- Pause the playback and turn the zoom lever to the W side to display the still images as a chapter index of the movie. Select the still image and press the  button to play back the movie from that point.

Monitor display

Shooting screen displays

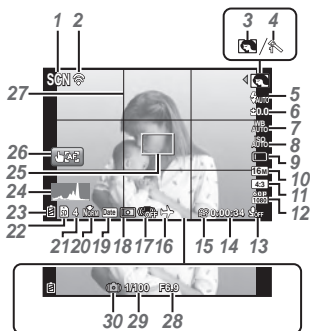

When the shutter button is pressed halfway down

Reading a histogram

If the peak fills too much of the frame, the image will appear mostly black.

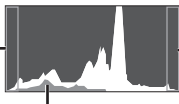

If the peak fills too much of the frame, the image will appear mostly white.

The green section shows luminance distribution within the screen's center.

Switching the displays

The displays change in the order of Normal → Detailed → No info. → Level Gauge each time the **INFO** button is pressed.  P. 67

No.	Name	Normal	Detailed	No info.	Level Gauge
1	Shooting mode	✓	✓	-	-
2	Connection to Smartphone	✓	✓	✓	✓
3	Sub mode	✓	✓	-	-
4	Picture Mode	✓	✓	-	-
5	Flash	✓	✓	-	-
6	Exposure compensation	✓	✓	-	-
7	White balance	✓	✓	-	-
8	ISO sensitivity	✓	✓	-	-
9		✓	✓	✓	-
10	Image size (still images)	✓	✓	-	-
11	Aspect	✓	✓	-	-
12	Image size (movies)	✓	✓	-	-
13	Recording with sound/ wind noise reduction	✓	✓	-	-
14	Movie recording length	✓	✓	-	-
15	Movie recording icon	✓	✓	-	-
16	World time	-	✓	-	-
17	Image stabilization	-	✓	-	-
18	Metering	-	✓	-	-
19	Date stamp	✓	✓	-	-
20	Compression	✓	✓	-	-
21	Number of storable still pictures	✓	✓	-	-
22	Current memory	✓	✓	-	-
23	Battery check	✓	✓	-	-
24	Histogram	-	✓	-	-
25	AF target mark	✓	✓	✓	✓
26	Touch Shutter	✓	✓	✓	✓
27	Grid Guide	-	✓	-	-
28	Aperture value	✓	✓	✓	✓
29	Shutter speed	✓	✓	✓	✓
30	Camera shake warning	✓	✓	✓	✓

Playback mode display

- Normal

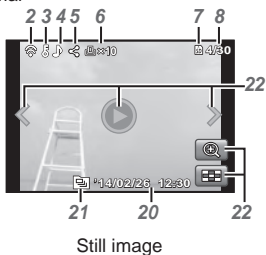

- No information



- Detailed

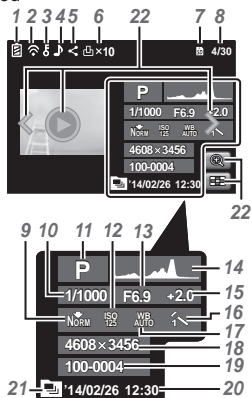

Switching the displays

The displays change in the order of Normal → Detailed → No info. each time the **INFO** button is pressed.

No.	Name	Normal	Detailed	No info.
1	Battery check	–	✓	–
2	Eye-Fi transfer data/Wi-Fi	✓	✓	–
3	Protect	✓	✓	–
4	Adding sound	✓	✓	–
5	Share order	✓	✓	–
6	Print reservation/number of prints	✓	✓	–
7	Current memory	✓	✓	–
8	Frame number/ total number of images	✓	✓	–
9	Compression/ Image size (movies)	–	✓	–
10	Shutter speed	–	✓	–
11	Shooting mode	–	✓	–
12	ISO sensitivity	–	✓	–
13	Aperture value	–	✓	–
14	Histogram	–	✓	–
15	Exposure compensation	–	✓	–
16	Picture mode/sub mode	–	✓	–
17	White balance	–	✓	–
18	Image size (still images)	–	✓	–
19	File name	–	✓	–
20	Recording date and time	✓	✓	–
21	Grouped images	✓	✓	✓
22	Touch screen button	✓	✓	✓

Shooting using basic functions

Using the shooting modes

Selecting shooting mode

Turn the mode dial to set the shooting mode to the indicator.

- After selecting **ART**, **SCN**, , , or , select the sub mode.



List of shooting mode

- The default settings of the function are highlighted in .

Shooting mode	Sub mode	
P (Program mode)	–	P. 10
M (Manual mode)	–	P. 24
ART (Art Filter)	Pop Art/Soft Focus/Pale&Light Color/ Grainy Film/Pin Hole/Diorama/Dramatic Tone	P. 25
SCN (Scene Mode)	Portrait/ e-Portrait/ Landscape/ Interval Shooting/ Night Scene/ Night+Portrait/ Sport/ Indoor/ Self Portrait/ Sunset/ Fireworks/ Cuisine/ Documents/ Beach & Snow/ Super Macro/ Backlight HDR	P. 26
(Hand-Held Starlight mode)	–	P. 28
(Panorama)	Auto/Manual	P. 28
(PHOTO STORY)	Standard/Speed/Zoom In/Out/Fun Frames	P. 30
(Advanced Movie mode)	Photo in Movie/ 60p 60p Movie/ HS High-Speed Movie/ Time Lapse Movie	P. 32
iAUTO (iAUTO mode)	–	P. 33

- “List of settings available in each shooting mode” (P. 97), “List of **SCN** settings” (P. 98), “List of **ART** settings” (P. 99)
- In certain shooting modes, the camera may take a few moments for image processing after taking a picture.

M (manual mode)

In mode **M**, you can set the aperture value, shutter speed, and ISO manually.

- The exposure difference from suitable exposure is displayed.

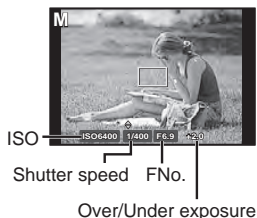

- 1 Rotate the mode dial to **M**.
- 2 Press Δ , and use $\triangleleft \triangleright$ to select aperture value (F-numbers), shutter speed, and ISO and use $\Delta \nabla$ to select each value.
- 3 Press the OK button to set.

ART (art filters)

You can shoot with color and effect like posters and paintings.

















Sub mode	Application
Pop Art	Enhances the color and atmosphere of an image more brightly and vividly.
Soft Focus	Expresses an ethereal atmosphere with a soft tone and makes an image dreamy.
Pale&Light Color	Expresses a comfortable floating feeling by making an image more pale and light.
Grainy Film	Expresses the strength and roughness of black and white.
Pin Hole	Expresses the tunnel effect like that obtained from an old fashioned camera or a toy camera by reducing the peripheral brightness.
Diorama	Expresses an image shooting a surreal miniature world with enhancing the saturation and contrast and blurring an out-of-focus area of an image.
Dramatic Tone	Enhances the local contrast of an image and provide an image that a difference of brightness and darkness is emphasized.

- 1 Rotate the mode dial to **ART**.
- 2 Use $\triangleleft \triangleright$ to select a sub mode and press the OK button at the end.
 - Press the OK button once again to display the sub mode selection screen.



SCN (scene mode)

Only by selecting a sub mode according to the subject or the scene, you can shoot with an proper setting.

Sub mode	Application
 Portrait	Suitable for portrait shooting.
 e-Portrait	Smooths out skin tones and texture. This mode is suitable when viewing images on a high-definition TV.
 Landscape	Suitable for landscape shooting.
 Interval Shooting	Automatically shoot successive images according to set [Start Waiting Time], [Frame], and [Interval Time].
 Night Scene	Suitable for tripod shooting of night scenes.
 Night+Portrait	Suitable for portrait shooting against a background of night view.
 Sport	Suitable for fast action shooting.
 Indoor	Suitable for shooting portraits indoors like party scene.
 Self Portrait	Suitable for shooting yourself with holding the camera.
 Sunset	Suitable for shooting the sunset.
 Fireworks	Suitable for shooting fireworks at night.
 Cuisine	Suitable for shooting cuisine.
 Documents	Suitable for shooting paper documents or time tables.
 Beach & Snow	Suitable for shooting at snow-capped mountains, seascapes in the sun, and other whitish scenes.
 Super Macro	Suitable for shooting extremely close-up images.
 Backlight HDR	Suitable for contrasting scenes. This mode captures multiple images and merges them into one, properly exposed image.

- 1 Rotate the mode dial to **SCN**.
- 2 Use $\triangleleft \triangleright$ to select a sub mode and press the OK button at the end.
 - Press the OK button once again to display the sub mode selection screen.



- In [e-Portrait] mode, two images are recorded: an unmodified image and a second image to which [e-Portrait] effects have been applied.

Interval Shooting

Adjusts interval settings in the setting menu before selecting Interval Shooting in **SCN** (Scene Mode) to shoot.

Customizing the setting

- 1 Press the **MENU** button to display the menus.
- 2 Use \triangleleft to move to the page tab, and use \triangle ∇ to select Setting menu 3 and then press \odot .

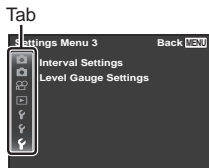

- 3 Use \triangle ∇ to select [Interval Shooting] and press \odot . Then press \triangle ∇ to select an item and press \odot .

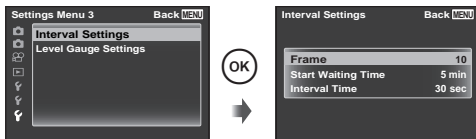

- 4 Use \triangle ∇ to highlight an option and press \odot to select.

Frame	Sets the number of frames to be shot between 1 and 99 frames.
Start Waiting Time	Sets the time from pressing the shutter button until the picture is taken between 0 and 60 minutes.
Interval Time	Sets the shooting interval for the second and subsequent frames per 10 seconds or between 1 and 60 minutes.

- Press the **MENU** button repeatedly to exit the menu.
- The interval may be longer than the set interval such as when the camera takes a few moments for image processing.
- Taken pictures are displayed as a group.
- For the free space on a card, you cannot shoot the set number of frames.
- The camera may go into sleep mode during interval shooting, but the shooting is performed according to the setting.

To cancel the interval shooting

Press the **MENU** button.





(Hand-Held Starlight)

Reduces blur when shooting low light/ illuminated scenes. The flash can be used.

- By pressing the shutter button once, the camera shoots multiple images automatically and continuously, and merges them into a high quality image with less noise.

(Panorama mode)





You can shoot and combine multiple images to create an image with a wide angle of view (panoramic image).

- 1 Rotate the mode dial to .
- 2 Press the  button to go to the function menu. Use   to select a sub mode and press the  button at the end.

Submenu	Application
Auto	Panorama images are automatically combined just by swinging the camera in the shooting direction.
Manual	Three frames are taken and combined by the camera. The user composes the shots using the guide frame and manually releases the shutter.

- Move the camera as if rotating it around a vertical axis through the center of the lens to take better panorama images.

Taking pictures with [Auto]

- ① Select [Auto] in the sub mode first. Press  and use   to select the angle of view (STD:180°, FULL:360°), and then press the  button.
- ② Point the camera to the start position.
- ③ Press the shutter button to begin shooting.
- ④ Start panning. When the arrow reaches the end of the guide, recording ends automatically.



Guide

- The camera automatically processes the images and the combined panorama image is displayed.
- To stop shooting in the middle, press the shutter button or  button. If the camera pauses for a while, shooting automatically finishes.
- If the message [Image was not created.] is displayed, shoot again.
- To cancel the panorama function, press the **MENU** button.

Taking pictures with [Manual]

- ① Use Δ ∇ \triangleleft \triangleright to specify at which edge the next picture is to be connected, and then press the OK button.
- ② Press the shutter button to take the first frame.
- ③ Compose the next shot so that the edge of the first frame displayed faintly on the screen overlaps the subject of the second frame, and press the shutter button.
 - To combine only two frames, press the OK button.
- ④ Repeat step ③ to take a third frame. The camera automatically combines the frames into a single panorama image.

Direction for combining frames





4 Tap a frame in standby mode to shoot.



- Tap the frame when the subject is not displayed in a frame.

5 Shoot each frame in the same way.



- Shot images are displayed in the frames.
- Touch any framed image and then  while  is displayed, so that the image is canceled, and you can retake the shot.
- Press the **MENU** button and select [Exit], and then press the  button to cancel the shot picture and restart shooting again.



6 After shooting all frames, press and save the picture.

- When changing a shooting mode in the middle of shooting, the shooting state will be automatically saved.
- AF Mode is fixed to [Spot].
- The image size is fixed at a size equivalent to [**8M**].
- The following operations are not available in the Photo Story mode.
Movie recording, sequential, and self-timer.

(Advanced Movie mode)

You can shoot the movie by using the evolving movie function.

Submenu	Description
 (Photo in Movie)	Captures still images as you shoot a movie. During a single movie, you can capture a maximum of 12 still images.
60p (60p Movie)	Shoots a smooth movie at 60 frames/second. Image size is fixed at full HD (1920×1080).
HS (High-Speed Movie)	Shoots a fast-moving subject and play back in slow motion. HS120fps (1280×720), HS240fps (432×324)
 (Time Lapse Movie)	Generate a movie for 20 seconds by shooting successive and interval images at set shooting time. You can set "shooting time" in the function menu. The camera automatically ends shooting for a set shooting time and record a time lapse movie.

- Except in Photo in Movie, you cannot take still images by pressing the shutter button. The Photo in Movie function is also enabled when shooting in **P** mode or **iAUTO** mode.
- The flash is not available when capturing still images using Photo in Movie.
- Images captured during Photo in Movie are displayed as a group.
- Only when High-Speed Movie, you can select [, [, and [Off] of the self-timer.
- While you shoot Time Lapse Movie, you cannot change the focus position.
- The camera may go into sleep mode during Time Lapse Movie, but the shooting is performed according to the setting.
- When the battery gets low during Time Lapse Movie, the camera stops shooting and starts saving the images you have taken on the card. For the battery remaining, the camera may fail to generate a movie. Use a full-charged battery.
- In Time Lapse Movie, pressing the  (movie) button while shooting stops the shooting.
The length of the movie is depending on the number of frames.

iAUTO (iAUTO mode)

A full auto mode in which the camera automatically optimizes settings for the current scene. The camera does all the work, which is convenient for beginners.

- 1 Rotate the mode dial to **iAUTO**.
- 2 Press the shutter button halfway down to focus.
The camera was unable to focus if the AF target mark flashes red. Try focusing again.
- 3 To take the picture, gently press the shutter button all the way down while being careful not to shake the camera.

Using the live guide

The live guide can be used to change settings in **iAUTO** mode.

- ① Press **OK** to display the live guide.
- ② Use $\Delta \nabla$ to highlight an item and press **OK**.

Guide items

- Change Color Saturation
- Change Color Image
- Change Brightness

- ③ Use $\Delta \nabla$ to choose a level and check the effect or description.
 - Press the shutter button halfway to select.
- ④ Press the shutter button to take a picture.
 - To clear the live guide from the display, press the **MENU** button.

- Touching the screen also changes the live guide setting levels.  P. 39
- Pictures may appear grainy at some live guide setting levels.
- Changes to the live guide setting levels may not be visible on the screen.
- The flash can not be used with the live guide.
- Changes to the live guide options cancel previous changes.
- Choosing the live guide settings that exceed the limits of the camera exposure meters may result in pictures that are over- or under-exposed.

Guide item



Level bar

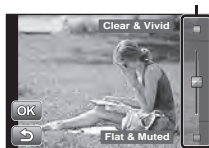

Using shooting options (Set by direct button)





Some items are not available in some shooting modes.  “List of settings available in each shooting mode” (P. 97)



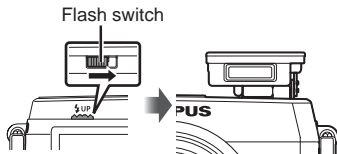

Flash



You can use a flash when shooting.

- 1 Slide the flash switch to raise the flash.



- 2 Press the  button () to display options.
- 3 Use   to choose a flash mode and press .

 AUTO Auto flash	The flash fires automatically in low light or backlight conditions.
 Red-eye reduction flash	This function allows you to reduce the red-eye phenomenon.
 Fill-in flash	The flash fires regardless of the light conditions.
 Flash off	The flash does not fire.

- In [] (Red-eye reduction flash), after the pre-flashes, it takes about 1 second before the shutter is released. Do not move the camera until shooting is complete.
- [] (Red-eye reduction flash) may not work effectively under some shooting conditions.

To turn off the flash

Press the flash down back into the camera.

Exposure compensation

Compensates the brightness (appropriate exposure) adjusted by the camera.

1 Press the +/- button (Δ), and then press $\triangleleft \triangleright$ for the exposure compensation.

- Choose positive (“+”) values to make pictures brighter, negative (“-”) values to make pictures darker.

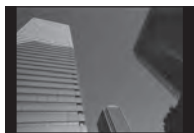

Negative (-)









No compensation (0)



Positive (+)

Single/Sequential

- 1 Press the  button (∇) to display the direct menu.
- 2 Select an option using \triangleleft \triangleright and press .

 Single-frame shooting	Shoots 1 frame at a time when the shutter button is pressed (normal shooting mode).
 Sequential 1 *1	The images are taken sequentially for 200 frames at up to about 2.5 frames per second (fps) while pressing down the shutter button all the way down.
 Sequential 2 *1	The images are taken sequentially for up to 16 frames at about 11.5 frames per second (fps) while pressing down the shutter button all the way down.
 High-Speed1 *1, 2	The images are taken sequentially for up to 60 frames at about 20 frames per second (fps) while pressing down the shutter button all the way down.
 High-Speed2 *1, 2	The images are taken sequentially for up to 60 frames at up to 60 frames per second (fps) while pressing down the shutter button all the way down.





*1 Taken pictures are displayed as a group.



*2 The number of recording pixels are limited.

- During sequential shooting, focus, exposure, and white balance are locked at the first frame.
- During sequential shooting, if the battery check blinks due to low battery, the camera stops shooting and starts saving the pictures you have taken on the card. The camera may not save all of the pictures depending on how much battery power remains.

Self timer

Sets the time after the shutter button is pressed until the picture is taken.



- 1 Press the  button (∇) to display the direct menu.
- 2 Select [, , or ] using \triangleleft \triangleright and press the  button.

 Self-timer 12 SEC	Press the shutter button halfway to focus, the rest of the way down to start the timer. First, the self-timer lamp lights up for approximately 10 seconds, then it blinks for approximately 2 seconds and the picture is taken.
 Self-timer 2 SEC	Press the shutter button halfway to focus, the rest of the way down to start the timer. The self-timer lamp blinks for approximately 2 seconds, and then the picture is taken.
 Custom Self-timer	After selecting this mode, press the MENU button to set "the number of frames, the time from pressing the shutter button until the picture is taken, and the interval time". Pictures are taken by these setting.

- To cancel the activated self-timer, press the **MENU** button.
- Self timer is not canceled automatically after shooting.

AFL (Focus lock)

You can lock the focus position.

- 1 Press the shutter button halfway to focus.
- 2 While keeping the position of the camera, press the  button.
 - The camera focuses and locks the position.
 - Press the  button again to release the focus lock.
 - Zooming operation, pressing the **MENU** button, and the other operations also release the focus lock.
 - After shooting, the focus lock is released.
 - Touching the screen also locks and releases the focus lock.  P. 39



Shooting using touch panel

By touching the screen, the subject to be focused on can be set or the picture can be taken.

- When using a monitor protector or gloves, touching operation may not work well.
- When touching operation is difficult with your finger, use the Stylus pen (supplied).

Every time is touched, the operation is changed.

: The subject that is touched is focused on and the picture is taken automatically.

: The subject that is touched is AF locked. Press the shutter button to take the picture. Touch to release the AF lock. Focus lock ends when the shutter is released.

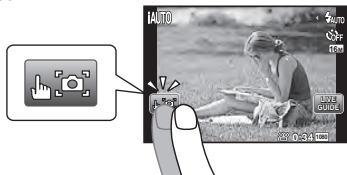

Using for the live guide (P. 33)

In **iAUTO** mode, the live guide can be set.

- 1 Touch .
 - Touch an item to set the level.
- 2 Drag the level bar slider vertically to set the level, and touch .
 - Touch to end the live guide.
 - Touch to cancel the setting.



Using shooting options (Set by function menu)

Some items are not available in some shooting modes.  “List of settings available in each shooting mode” (P. 97)

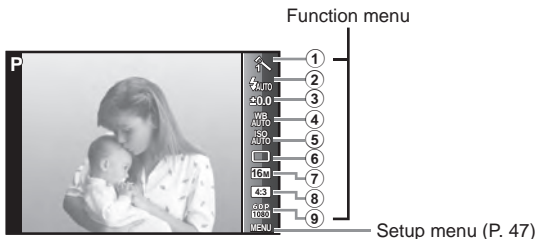





Function menu

- | | |
|------------------------------------|--|
| ① Picture Mode.....P. 41 | ⑥ P. 43 |
| ② Flash.....P. 41 | ⑦ Image Size (still images).....P. 43 |
| ③ Exposure compensationP. 42 | ⑧ Aspect.....P. 43 |
| ④ White balance.....P. 42 | ⑨ Image size (movies).....P. 44 |
| ⑤ ISO sensitivity.....P. 42 | |

1 Press  to display the function menu.







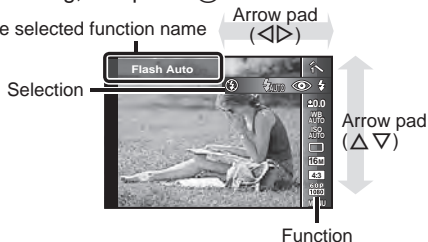











- To hide the function menu, press  again.









2 Use   on the arrow pad to select settings, use   to change the selected setting, and press .

Displays the selected function name









- The default settings of the function are highlighted in .

Picture Mode		Sets the processing options.
	Vivid	Produces vivid colors.
	Natural	Produces natural colors.
	Muted	Produces flat tones.
	Fish Eye	Produces distortion with the effect of shooting with a fisheye lens.
	Sparkle	Produces twinkling lights with the effect of shooting with a cross filter.
	Reflection	Makes an image with the effect of reflecting in a mirror.
	Fragmented	Makes an image into a collage of tiles. This mode produces the effect of mosaic art.
	Pop Art	Enhances the color and atmosphere of an image more brightly and vividly.
	Soft Focus	Expresses an ethereal atmosphere with a soft tone and makes an image dreamy.
	Pale&Light Color	Expresses a comfortable floating feeling by making an image more pale and light.
	Grainy Film	Expresses the strength and roughness of black and white.
	Pin Hole	Expresses the tunnel effect like that obtained from an old fashioned camera or a toy camera by reducing the peripheral brightness.
	Diorama	Expresses an image shooting a surreal miniature world with enhancing the saturation and contrast and blurring an out-of-focus area of an image.
	Dramatic Tone	Enhances the local contrast of an image and provide an image that a difference of brightness and darkness is emphasized.
Flash		Sets the flash firing method.
	Flash Auto	The flash fires automatically in low-light or backlight conditions.
	Redeye	Pre-flashes are emitted to reduce the occurrence of red eye in your photos.
	Fill In	The flash fires regardless of the available light.
	Flash Off	The flash does not fire.

Exposure compensation		Compensates the brightness (appropriate exposure) adjusted by the camera.
-2.0 to +2.0 Value		Set a larger negative (-) value to adjust darker, or a larger positive (+) value to adjust brighter.
White balance		Sets an appropriate color scheme for the light of the shooting scene.
 WB AUTO	WB Auto	The camera automatically adjusts the white balance.
	Sunny	Suitable for shooting outdoors under a clear sky.
	Cloudy	Suitable for shooting outdoors under a cloudy sky.
	Incandescent	Suitable for shooting under tungsten lighting.
	Fluorescent	Suitable for shooting under white fluorescent lighting.
	One Touch 1	For manually adjusting the white balance according to the light when shooting. Set a piece of white paper or other white object so that it fills the entire screen, and press the MENU button to set the white balance. For how to register one touch white balance, see "Registering one touch white balance" (P. 44).
	One Touch 2	
ISO sensitivity		Sets the ISO sensitivity.
 ISO AUTO	ISO Auto	The camera automatically sets the sensitivity with priority on image quality.
 ISO HIGH	High ISO Auto	The camera automatically sets the sensitivity with priority on minimizing blur caused by a moving subject or by camera shake.
ISO 125 to ISO 6400 Value		Set a smaller value to reduce noise in the picture, or a larger value to reduce blur.

		Sets the sequential shooting function and the time from pressing the shutter button until the picture is taken.
	Single	One frame is shot each time the shutter button is pressed.
	Sequential 1	The images are taken sequentially for 200 frames at up to about 2.5 frames per second (fps) while pressing down the shutter button all the way down.
	Sequential 2	The images are taken sequentially for up to 16 frames at about 11.5 frames per second (fps) while pressing down the shutter button all the way down.
	High-Speed1	The images are taken sequentially for up to 60 frames at about 20 frames per second (fps) while pressing down the shutter button all the way down.
	High-Speed2	The images are taken sequentially for up to 60 frames at up to 60 frames per second (fps) while pressing down the shutter button all the way down.
	12 sec	The self-timer lamp turns on for approx. 10 seconds, then blinks for approx. 2 seconds, and then the picture is taken.
	2 sec	The self-timer lamp blinks for approx. 2 seconds, then the picture is taken.
	Custom Self-timer	Photographs are taken at “the number of frames, the time from pressing the shutter button until the picture is taken, and the interval time” which you set.
Image size (still images)		Sets the number of recording pixels.
	4608×3456	Suitable for printing pictures over A3 (11×17 in.).
	3200×2400	Suitable for printing pictures up to A3 (11×17 in.).
	1920×1440	Suitable for printing pictures up to A4 size (8.5×11 in.).
	640×480	Suitable for using pictures on emails.
Aspect		Sets the horizontal-to-vertical ratio of images.
	4:3	Change the horizontal-to-vertical ratio when taking pictures.
	16:9	
	3:2	
	1:1	



Image size (movies)		Sets the number of recording pixels.
 1080 60p ^{*1}		Shoots smooth full HD movies at 60 frames per second (fps).
 1080p		Shoots full HD movies.
 720p		Shoots HD movies.
 VGA		Shoots 640x480 movies.
 HS 120 ^{*1, 2}		Shoots 1280x720 HS movies.
 HS 240 ^{*1, 2}		Shoots 432x324 HS movies.

^{*1} You can set only when [Vivid], [Natural], and [Muted] is set on the picture mode in **P** and **M** mode and [ Super Macro].

^{*2} HS movie: Film quickly moving subjects for slow-motion playback.

- In certain shooting modes, some functions cannot be set.  “List of settings available in each shooting mode” (P. 97).
- Examples of image size when the aspect ratio is 4:3.

Registering one touch white balance

Select [ One Touch 1] or [ One Touch 2], face the camera toward a piece of white paper or other white object, and press the **MENU** button.

- The camera releases the shutter and the white balance is registered. When the white balance was previously registered, the registered data is updated.
- The registered white balance data will not be cleared by turning off the power.
- Perform this procedure under the light where the pictures will be actually taken.
- When the camera settings are changed, the white balance must be registered again.
- When the white balance cannot be registered, check that the white paper fills the screen, and then perform the procedure again.

Using the setup menu functions

Setup menu

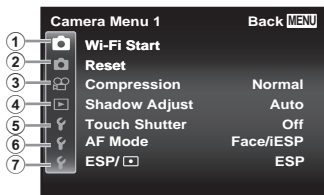

1 Camera Menu 1 P. 48

	Wi-Fi Start/End Wi-Fi (P. 68) Reset Compression Shadow Adjust Touch Shutter AF Mode ESP/
--	--

2 Camera Menu 2 P. 51

	Digital Zoom Image Stabilizer (Still images) AF Illuminat. Rec View Pic Orientation Date Stamp Super-Res Zoom
--	---

3 Movie Menu P. 55

	IS Movie Mode (Movie sound recording) Wind Noise Setting
--	--

4 Playback Menu P. 56

	Slideshow Edit Erase Print Order (P. 78) (Protect) Share Order (P. 70)
--	---

5 Settings Menu 1 P. 62

	Memory Format/Format Backup Eye-Fi USB Connection Power On Sound Settings Pixel Mapping
--	---

6 Settings Menu 2 P. 64

	(Monitor) TV Out (Language) (Date/time) World Time Touch Calibration Wi-Fi Settings
--	---

7 Settings Menu 3 P. 67

	Interval Settings Level Gauge Settings
--	---

Using the setup menu

Press the **MENU** button during shooting or playback to display the setup menu.

The setup menu provides access to a variety of camera settings, such as shooting and playback functions, time and date settings, and display options.

- 1 Press the **MENU** button.
 - The setup menu is displayed.

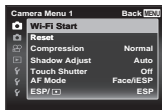

- 2 Press \triangleleft to select the page tabs. Use \triangle ∇ to select the desired page tab and press \triangleright .

Page tab

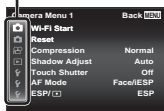

Submenu 1

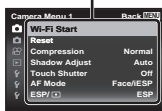

- 3 Use \triangle ∇ to select the desired submenu 1 and then press the OK button.



Submenu 2

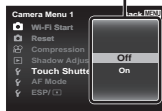

- 4 Use \triangle ∇ to select the desired submenu 2 and then press the OK button.

- Once a setting is selected, the display returns to the Submenu 1.
- There may be additional operations.



- 5 Press the **MENU** button to complete the setting.





For the operation method, refer to (P. 47).

- The default settings of the function are highlighted in .

Camera Menu 1

Restoring the shooting functions to the default settings

[Reset]

Submenu 2	Application
Yes	Restores the following menu functions to the default settings. <ul style="list-style-type: none">• Sub mode of ART, SCN, , , and .• Set value of M mode• Picture Mode• Flash• Exposure compensation• White balance• ISO sensitivity• /🕒• Image Size (still images)• Aspect• Image Size (movies)• Camera Menu 1, Camera Menu 2 and Movie Menu Functions
No	The settings will not be changed.

Selecting the image quality for still images [Compression]

Submenu 2	Application
Fine	Shooting at high quality.
Normal	Shooting at normal quality.

- “Number of storable pictures (still images)/Recording length (movies) in the internal memory and cards” (P. 96)

For the operation method, refer to (P. 47).

Brightening the subject against backlight [Shadow Adjust]

Submenu 2	Application
Auto	Automatically On when a compatible shooting mode is selected.
Off	The effect is not applied.
On	Shoot with automatic adjustment to brighten an area that has become darker.

- When [ESP/

Setting the Touch Shutter function [Touch Shutter]

Submenu 2	Application
Off	The subject that is touched is AF locked. (Press the shutter button manually.)
On	The subject that is touched is focused on and the picture is taken automatically.

- This setting can also be changed by touching the panel.  P. 39

For the operation method, refer to (P. 47).



Selecting the focusing area [AF Mode]

Submenu 2	Application
Face/iESP	The camera focuses automatically. (If a face is detected, it is shown by a white frame ^{*1} ; when the shutter button is pressed halfway and the camera focuses, the frame turns to green ^{*2} . If no face is detected, the camera chooses a subject in the frame and focuses automatically.)
Spot	The camera focuses on the subject located within the AF target mark.
AF Tracking	The camera tracks the subject movement automatically to focus on it continuously.

^{*1} For some subjects, the frame may not appear or may take some time to appear.

^{*2} If the frame blinks in red, the camera cannot focus. Try refocusing on the subject.

To focus on a moving subject continuously (AF Tracking)

- ① Hold the camera to align the AF target mark on the subject and press the  button.
- ② When the camera recognizes the subject, the AF target mark automatically tracks the subject movement to focus on it continuously.
- ③ To cancel the tracking, press the  button.
 - Depending on the subjects or the shooting conditions, the camera may be unable to lock the focus or fail to track the subject movement.
 - When the camera fails to track the subject movement, the AF target mark changes to red.

For the operation method, refer to (P. 47).

Selecting the method for measuring the brightness

[ESP/

Submenu 2	Application
ESP	Shoots to obtain a balanced brightness over the entire screen (Meters the brightness at the center and surrounding areas of the screen separately).
 (spot)	Shoots the subject at the center during backlighting (Meters the brightness at the center of the screen).

- When set to [ESP], the center may appear dark when shooting against strong backlighting.

Camera Menu 2

Shooting at higher magnifications than optical zoom

[Digital Zoom]

Submenu 2	Application
Off	Disable digital zoom.
On	Enable digital zoom.

- The option selected for [Digital Zoom] affects the appearance of the zoom bar (P. 54).

For the operation method, refer to (P. 47).

Reducing the blur caused by the camera shake when shooting **[Image Stabilizer]**

Submenu 2	Application
Off	The image stabilizer is deactivated. This is recommended for shooting when the camera is fixed in place on a tripod or other stable surface.
On	The image stabilizer is activated.
While Exposing	Image stabilization is activated when the shutter button is pressed all the way down.

- There may be a noise coming from inside the camera when reducing camera shake.
- Images may not be stabilized if camera shake is too severe.
- When the shutter speed is extremely slow, such as when taking pictures at night, [Image Stabilizer] may not be as effective.

Using the assist lamp for shooting a dark subject **[AF Illuminat.]**

Submenu 2	Application
Off	The AF illuminator is not used.
On	When the shutter button is pressed halfway down, the AF illuminator turns on to aid focusing.

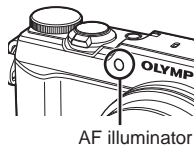

For the operation method, refer to (P. 47).

Viewing the image immediately after shooting [Rec View]

Submenu 2	Application
Off	The image being recorded is not displayed. This allows the user to prepare for the next shot while following the subject in the monitor after shooting.
1/2/3 (sec)	The image being recorded is displayed for selected second(s). This allows the user to make a brief check of the image that was just taken.







Automatically rotating images shot with the camera in a vertical position during playback [Pic Orientation]

- During shooting, the  (P. 59) setting on the playback menu is set automatically.
- This function may not work properly if the camera is facing up or down during shooting.

Submenu 2	Application
Off	Information about the vertical/horizontal orientation of the camera during shooting is not recorded with images. Images shot with the camera in a vertical position are not rotated during playback.
On	Information about the vertical/horizontal orientation of the camera during shooting is recorded with images. Images are automatically rotated during playback.

Imprinting the date of recording [Date Stamp]

Submenu 2	Application
Off	Do not imprint the date.
On	Stamp new photographs with the date of recording.





- When the date and time are not set, [Date Stamp] cannot be set.   (P. 65)
- The date stamp can not be deleted.
- You cannot set [Date Stamp] when drive settings are , , , and , and the picture mode is except [Vivid], [Natural], and [Muted].

For the operation method, refer to (P. 47).

Shooting larger pictures than when using optical zoom with low degrading of image quality [Super-Res Zoom]

Submenu 2	Application
Off	Disable super-resolution zoom.
On	Enable super-resolution zoom.

- [Super-Res Zoom] is available only when [Image Size] is set to **[16M]**.

Super-resolution zoom	Digital zoom	Image size	Zoom bar
On	Off	16M	 Super-resolution zoom
Off	On	16M	 Digital zoom
		Other	 *1
On	On	16M	 Super-resolution zoom Digital zoom

*1 Due to increased processing of the pixel counts, the image quality will not degrade. The magnification ratio changes depending on the image size setting.

- Photographs taken with the zoom bar displayed in red may appear “grainy”.

For the operation method, refer to (P. 47).

Movie Menu

Reducing the blur caused by the camera shake when shooting

[IS Movie Mode]

Submenu 2	Application
Off	The image stabilizer is deactivated. This is recommended for shooting when the camera is fixed in place on a tripod or other stable surface.
On	The image stabilizer is activated.
On Hybrid	The image stabilizer is activated. This function compensates for large-amplitude shake, such as the slow kind which occurs if you shoot while walking.

- Images may not be stabilized if camera shake is too severe.
- In HS movie mode, [On Hybrid] cannot be used.

Recording sound when shooting movies **[U]**

Submenu 2	Application
Off	No sound is recorded.
On	Sound is recorded.

- Sound is not recorded when an HS movie mode is selected.

Reduce wind noise in the recorded sound when recording movie **[Wind Noise Setting]**



Submenu 2	Application
Off	Disable Wind Noise Reduction.
On	Uses Wind Noise Reduction.

For the operation method, refer to (P. 47).





Playback Menu

Playing back pictures automatically [Slideshow]

Submenu 2	Submenu 3	Application
BGM	Off/ Cosmic/ Breeze/ Mellow/ Dreamy/ Urban	Selects the background music options.
Start	—	Starts the slideshow.

- During a slideshow, press  to advance one frame,  to go back one frame.
- Press the **MENU** button or the  button to stop the slideshow.

Editing still images [Edit]





Submenu 1	Submenu 2
Edit (still images)	 P. 57
	 P. 57
	 P. 58
	Shadow Adj P. 58
	Redeye Fix P. 58
	 P. 59
	e-Portrait P. 59
Edit (movies)	In-Movie Image Capture P. 59
	Movie Trimming P. 60

For the operation method, refer to (P. 47).

Changing the image size









This saves a high-resolution image as a separate image with a smaller size for use in e-mail attachments and other applications.

Submenu 1	Submenu 2	Submenu 3
Edit		3M VGA

- ① Use   to select an image.
- ② Use   to select an image size and press the  button.
 - The resized image is saved as a separate image.

Cropping image

Submenu 1	Submenu 2
Edit	

- ① Use   to select an image, and press the  button.
- ② Use the zoom lever to select the size of the cropping frame, and use     to move the frame.
- ③ Press the  button after you have selected the area to trim.
 - The edited image is saved as a separate image.



Cropping frame



For the operation method, refer to (P. 47).

Adding sound to still images

Submenu 1	Submenu 2
Edit	

- ① Use   to select an image.
- ② Aim the microphone toward the sound source.
- ③ Press the  button.
 - Recording starts.
 - The camera adds (records) sound for approx. 4 seconds while playing back the image.

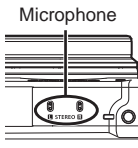



To play sound recordings

To play sound recorded with an image, select the image and press the  button.

- Press   to adjust volume.



Brightening areas that are dark due to backlight or other reasons *[Shadow Adj]*

Submenu 1	Submenu 2
Edit	Shadow Adj

- ① Use   to select an image, and press the  button.
 - The edited image is saved as a separate image.
 - Depending on the picture, the editing may not be effective.
 - The retouching process may lower the image resolution.

Retouching red eyes in flash shooting *[Redeye Fix]*



Submenu 1	Submenu 2
Edit	Redeye Fix

- ① Use   to select an image, and press the  button.
 - The edited image is saved as a separate image.
 - Depending on the picture, the editing may not be effective.
 - The retouching process may lower the image resolution.

For the operation method, refer to (P. 47).



Rotating images

Submenu 1	Submenu 2
Edit	

- ① Use   to select an image.
- ② Press the  button to rotate the image.
- ③ If necessary, repeat Steps ① and ② to make settings for other images, and press the **MENU** button.
 - The new picture orientations will be saved even after the power is turned off.

Smoothing skin tone [e-Portrait]







Submenu 1	Submenu 2
Edit	e-Portrait

- ① Use   to select an image, and press the  button.
 - Some images cannot be adjusted such as when faces are undetectable.
 - The edited image is saved as a separate image.

Capturing still images from movies

[In-Movie Image Capture]

Submenu 1	Submenu 2
Edit	In-Movie Image Capture

- ① Use   to select the movie and press the  button.
- ② Use    to display the frame to be captured and press the  button.
 - The selected frame is recorded as a still image.
 - Some frames cannot be captured.









Frame position













For the operation method, refer to (P. 47).

Trimming long movies [Movie Trimming]





Submenu 1	Submenu 2
Edit	Movie Trimming

- ① Use   to select the movie and press the  button.
- ② Use   to select saving method and press the  button.

Submenu 3	Application
New File	Records the trimmed movie as new movie file.
Overwrite	Overwrites the original movie with the trimmed movie.

- ③ Use     to display the frame to start erasing, and then press the  button.
- ④ Use     to display the frame to end erasing, and then press the  button.
- ⑤ Use   to select [Erase] and press the  button.
 - To cancel trimming, select [Cancel].
 - Movie trimming is processed by seconds. The movie length is automatically adjusted so that the selected start and end frames are included.

When editing movies in a group

- ① Expand the desired group.  “Playing back grouped images” (P. 17)
- ② Use   to select the movie and press the  button.
 - When you expand the group to edit respective movie, the edited movie can be saved respectively as [New File].





For the operation method, refer to (P. 47).

Erasing images [Erase]

Submenu 2	Application
All Erase	All images in the internal memory or card will be erased.
Sel. Image	Images are individually selected and erased.
Erase	Deletes the image displayed.
Erase Group	All images in the group are erased. To erase each image in the group, refer to “  Playing back panorama and grouped images” (P. 16).



- When erasing pictures in the internal memory, do not insert the card into the camera.
- Protected images cannot be erased.

To individually select and erase images [Sel. Image]

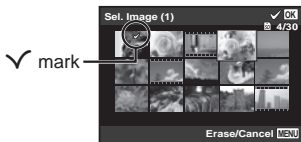
- ① Use $\Delta \nabla$ to select [Sel. Image], and press the  button.
- ② Use $\Delta \nabla \langle \rangle$ to select the image to be erased, and press the  button to add a  mark to the image.
 - Turn the zoom lever to the T end to return to the single frame display.
- ③ Repeat Step ② to select the images to be erased, and then press the **MENU** button to erase the selected images.
- ④ Use $\Delta \nabla$ to select [Yes], and press the  button.
 - The images with a  mark are erased.







To erase all images [All Erase]

- ① Use $\Delta \nabla$ to select [All Erase], and press the  button.
- ② Use $\Delta \nabla$ to select [Yes], and press the  button.

For the operation method, refer to (P. 47).

Protecting images [5]

- Protected images cannot be erased by [Erase] (P. 15, 61), [Sel. Image], [Erase Group], or [All Erase] (P. 61), but all images are erased by [Memory Format]/[Format] (P. 62).
- Use   to select an image.
 - Press the  button.
 - Press the  button again to cancel the settings.
 - If necessary, repeat Steps ① and ② to protect other images, and press the **MENU** button.
 - If you protect the grouped images, all images in the group will be protected at once. To protect each image in the group, expand images.  "Playing back panorama and grouped images" (P. 16)

Ÿ Settings Menu 1

Erasing data completely Ÿ [Memory Format]/ Ÿ [Format]

- Before formatting, check that no important data is left in the internal memory or card.
- Cards must be formatted with this camera before first use or after being used with other cameras or computers.
- Be sure to remove the card before formatting the internal memory.

Submenu 2	Application
Yes	Completely erases the image data in the internal memory or card (including protected images).
No	Cancels formatting.

Copying images in the internal memory to the card Ÿ [Backup]

Submenu 2	Application
Yes	Backs up image data in the internal memory to the card.
No	Cancels the backup.

For the operation method, refer to (P. 47).

Using an Eye-Fi card Ÿ [Eye-Fi]

Submenu 2	Application
All	Transfers all images.
Sel. Image	Transfers only selected image.
Off	Disable Eye-Fi communication.

- When using an Eye-Fi card, read the Eye-Fi card instruction manual carefully, and comply with the instructions.
- Use the Eye-Fi card in compliance with the laws and regulations of the country where the camera is used.
- In locations such as on an airplane, where the Eye-Fi communication is prohibited, remove the Eye-Fi card from the camera, or set [Eye-Fi] to [Off].
- This camera does not support the Eye-Fi card's Endless mode.

Selecting a method for connecting the camera to other devices Ÿ [USB Connection]

Submenu 2	Application
Auto	Set to select the connection method each time the camera is connected to another device.
Storage	Connect camera as a card reader.
MTP	For Windows Vista/Windows 7/Windows 8/Windows 8.1, connect camera as a portable device.
Print	Select when connecting to a PictBridge-compatible printer.

- When using the supplied software, select [Storage].
- Refer to "Connecting the camera to a computer" (P. 80) for the connection method with a computer.

For the operation method, refer to (P. 47).

Turning on the camera with the button \int [Power On]

Submenu 2	Application
No	The camera is not turned on. To turn on the camera, press the ON/OFF button.
Yes	Press and hold the  button to turn the camera on in the playback mode.

Selecting the camera sound and its volume \int [Sound Settings]

Submenu 2	Submenu 3	Application
Sound Type	1/2/3	Selects the camera sounds (operation sounds, shutter sound, and warning sound).
Volume	0/1/2/3/4/5	Selects the operation volume of camera buttons.
 Volume	0/1/2/3/4/5	Selects the image playback volume.

Adjusting the image processing function \int [Pixel Mapping]

- This function has already been adjusted at factory shipping, and no adjustment is needed right after purchase. Approximately once a year is recommended.
- For best results, wait at least one minute after taking or viewing pictures before performing pixel mapping. If the camera is turned off during pixel mapping, be sure to perform it again.

To adjust the image processing function

Press the  button when [Start] (Submenu 2) is displayed.

- The check and adjustment of the image processing function starts.

\int Settings Menu 2

Adjusting the brightness of the monitor \int [

- ① Use Δ ∇ to adjust the brightness while viewing the monitor, and then press the  button.

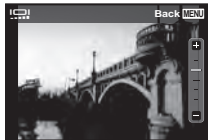

For the operation method, refer to (P. 47).

Playing back images on a TV ♪ [TV Out]

- ! The TV video signal system varies depending on the countries and regions. Before viewing camera images on your TV, select the video output according to your TV's video signal type.

Submenu 2	Submenu 3	Application
NTSC/PAL	NTSC	Connecting the camera to a TV in North America, Taiwan, Korea, Japan, and so on.
	PAL	Connecting the camera to a TV in European countries, China, and so on.
HDMI Out	480p/576p 720p 1080i 1080p	Set the signal format to be given priority. If the TV setting does not match, it is changed automatically.
HDMI Control	Off	Operate with the camera.
	On	Operate with the TV remote control.

- For the connection method, refer to “Viewing camera images on TV” (P. 72).

Changing the display language ♪ [🗨️]

Submenu 2	Application
Languages	The language for the menus and error messages displayed on the monitor is selected.

Setting the date and time ♪ [🕒]

- ① Press $\Delta \nabla$ of the arrow pad to select the year for [Y].
 - ② Press \blacktriangleright of the arrow pad to save the setting for [Y].
 - ③ As in Steps ① and ②, press $\Delta \nabla \blacktriangleleft \blacktriangleright$ of the arrow pad to set [M] (month), [D] (day), [Time] (hours and minutes), and [Y/M/D] (date order), and then press the OK button.
- For precise time setting, press the OK button as the time signal strikes 00 seconds.









To check the date and time



Press and hold the **INFO** button while the camera is turned off. The current time is displayed for approx. 3 seconds.



For the operation method, refer to (P. 47).

Choosing home and alternate time zones \checkmark [World Time]

- You will not be able to select a time zone using [World Time] if the camera clock has not first been set using [🕒].

Submenu 2	Submenu 3	Application
Home/ Alternate		The time in the home time zone (the time zone selected for  in submenu 2).
		The time in the travel destination time zone (the time zone selected for  in submenu 2).
 ^{*1}	—	Select the home time zone ( .
 ^{*1, 2}	—	Select the travel destination time zone ( .



^{*1} In areas where daylight saving time is in effect, use   to turn daylight saving time ([Summer]) on.

^{*2} When you select a time zone, the camera automatically calculates the time difference between the selected zone and the home time zone () to display the time in the travel destination time zone (.

Calibrating the touch panel \checkmark [Touch Calibration]

Touch the panel following the instructions on the screen with the Stylus pen.

Setting Wi-Fi \checkmark [Wi-Fi Settings]

Submenu 2	Application
Connection Settings	Set the connection mode.  "Using Wi-Fi function" (P. 68)
Private	Regenerate a password.
Reset 	Cancel all images selected for sharing.
Reset Wi-Fi Settings	Reset Wi-Fi settings to the default settings.

- For the operation method, refer to "Setting up a wireless LAN connection (Wi-Fi Settings)" (P. 69).

For the operation method, refer to (P. 47).

ƒ Settings Menu 3

Adjusting interval settings ƒ [Interval Settings]

Submenu 2	Submenu 3
Frame	1 to 99 (frames)
Start Waiting Time	00 to 60 (minutes)
Interval Time	10/20/30/40/50 (sec.)/01 to 60 (minutes)

Designing type of level gauge display

ƒ [Level Gauge Settings]

Submenu 2	Submenu 3	Application
Level Gauge Display	Off	Hide level gauge.
	On	Display level gauge.
Level Adjust	Reset	Restore the factory default angle.
	Adjust	Set the virtual horizon to the camera's current angle.

Level gauge display

- Indicate the orientation of the camera. The “tilt” direction is indicated on the vertical bar and the “horizon” direction on the horizontal bar.
- Use the indicators on the level gauge as a guide.
- If the level gauge does not indicate the orientation correctly, calibrate the angle of the level gauge.



Using Wi-Fi function

Using the wireless LAN functions on the camera, you can connect to a smartphone with Wi-Fi connectivity to view or transfer images on your smartphone, and to operate the camera by remote control.

The position information will be added to images on the memory card.

To use this function, you must have the relevant app installed on the smartphone.

<http://oishare.olympus-imaging.com/>

- **GPS** is displayed on images to which position information has been added. Log position information is only available when using a smartphone with a GPS function.
- Set the time and area of the camera precisely before using.
- ! Before using the wireless LAN function, read "Precautions when using the wireless LAN function" (P. 103).
- ! If using the wireless LAN function in a country outside the region where the camera was purchased, there is a risk that the camera will not conform to the wireless communication regulations of that country. Olympus will not be held responsible for any failure to meet such regulations.
- ! Depending on the country or region, Wi-Fi and/or GPS is subject to the laws. Therefore, you may not receive a repair service. Contact Olympus authorized service station in advance.
- ! As with any wireless communication, there is always a risk of interception by a third party.
- ! The wireless LAN function on the camera cannot be used to connect to a home or public access point.
- ! While charging with F-2AC and connecting to USB device, Wi-Fi connection is unavailable.

Setting up a wireless LAN connection (Wi-Fi Settings)

To use the wireless LAN functions on the camera (P. 70), you need to make setting such as the password to be used when connecting.

Setting password selection method

- ① Select [Wi-Fi Settings] in the **f** Settings Menu 2 and press **OK**.
- ② Select [Wi-Fi Connect Settings] and press **▷**.
- ③ Select the wireless LAN connection method and press **OK**.

Submenu 2	Submenu 3	Application
Connection Settings	Private	Connects to one smartphone (Connect using a preset password.). All images in the camera are available for viewing.
	One-Time	Connects to two or more smartphones (Connect using a different password each time.). Only the images selected for sharing are available for viewing.
	Select	Select which method to use each time.
	Off	Wi-Fi function is turned off.

Changing private connection password

Change the password used for [Private].

- ① Select [Wi-Fi Settings] in the **f** Settings Menu 2 and press **OK**.
- ② Select [Private] and press **▷**.
 - Pressing **△** generates and displays a different password. A present password is overwritten.

Cancelling image sharing

Deselects images selected for sharing (P. 70) when connected to a wireless LAN network.

- ① Select [Wi-Fi Settings] in the **f** Settings Menu 2 and press **OK**.
- ② Select [Reset ▷.
- ③ Select [Yes] and press **OK**.

Initializing wireless LAN settings

Initializes content of [Wi-Fi Settings].

- ① Select [Wi-Fi Settings] in the **f** Settings Menu 2 and press **OK**.
 - ② Select [Reset Wi-Fi Settings] and press **▷**.
 - ③ Select [Yes] and press **OK**.
 - A password is randomly changed.
- !** The wireless LAN antenna is contained in the camera grip. Where possible, avoid covering the antenna with your hands.
- !** During wireless LAN connection, the battery will run down faster. If the battery is running low, the connection may be lost during a transfer.
- !** Connection may be difficult or slow in proximity to devices that generate magnetic fields, static electricity or radio waves, such as near microwaves, cordless telephone.

Sharing images over Wi-Fi connection

Share Order

With [One-Time], you can select the images to share in advance.

- ① Display the setup menu.
 - "Using the setup menu" (P. 47)
 - ② From the playback menu, select [Share Order] and then press the **OK** button.
 - ③ Use **◀▶** to select an image for sharing and press **OK** to display **◀**.
 - ④ Repeat ③ to select all images for sharing, and then press the **MENU** button to end [Share Order].
 - **◀** is displayed on the images selected for sharing.
- !** You can set a share order on a maximum around 200 frames.

Start Wi-Fi connection for sharing images (Wi-Fi Start)

You can view images directly on a smartphone that has Wi-Fi connectivity or transfer images between the camera and a smartphone that has Wi-Fi connectivity.

To use this function, you must install and start the relevant app for the smartphone

"OI.Share (OLYMPUS IMAGE SHARE)".

- ① Select [Wi-Fi Start] in the **⌘** Camera Menu 1 and press **OK**.
 - Pressing and holding the **MENU** button also starts Wi-Fi connection.
 - When [Connection Settings] is set to [Off], [Wi-Fi Start] is not available.
- ② Select the connection method and press **OK**.
 - Depending on the setting of [Connection Settings], the connection method is varied as follows.

Private connection

- Sets SSID and a password with your smartphone.
Reading a QR code with OI.Share sets SSID and a password automatically.
From the second time, the same setting is automatically applied for the connection.

One-time connection

- Sets SSID and a password with your smartphone every time.
Reading a QR code with OI.Share sets SSID and a password automatically.

Select

- Select which method to use each time.
- ③ To end the connection, press and hold **MENU** on the camera.
 - While selecting Remote Shutter Mode in OI.Share, press **OK** after a QR code is displayed.

Connecting the camera to another device

Viewing camera images on TV

Use the AV cable (sold separately) to playback recorded images on your TV. You can play back high-definition images on a high-definition TV by connecting it to the camera using the HDMI cable.

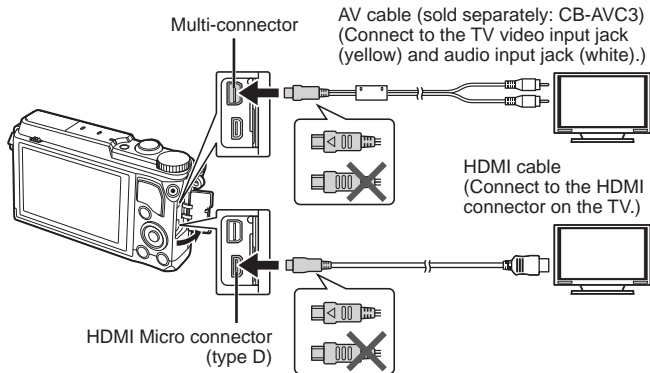

1 Use the cable to connect the camera to the TV.

- Choose the camera video mode before connecting the camera via an AV cable. [TV Out] (P. 65)

2 Choose the TV input channel.

- The camera monitor turns off when the cable is connected.
- Press the button when connecting via an AV cable.
- For details on changing the input source of the TV, refer to the TV's instruction manual.
- Depending on the TV's settings, the displayed images and information may become cropped.

- If the camera is connected using both an A/V and HDMI cable, it will assign priority to HDMI.
- Do not connect the USB cable and HDMI cable at the same time.
- If the camera is connected via an HDMI cable, you will be able to choose the digital video signal type. Choose a format that matches the input format selected with the TV.

1080p	Priority is given to 1080p HDMI output.
1080i	Priority is given to 1080i HDMI output.
720p	Priority is given to 720p HDMI output.
480p/576p	480p/576p HDMI output. 576p is used when [PAL] is selected for [TV Out] (P. 65).

Using the TV remote control

The camera can be operated by a TV remote control when connected to a TV that supports HDMI control.

- 1** Select [TV Out] in Settings Menu 2.
 - 2** Select [HDMI Control] and choose [On].
 - 3** Operate the camera by using the TV remote control.
 - You can operate the camera by following the operation guide displayed on the TV.
 - Some televisions may not support all features.
- You cannot shoot pictures or movies when the HDMI cable is connected.
 - Do not connect the camera to other HDMI output devices. Doing so may damage the camera.
 - HDMI output is not performed while connected via USB to a computer or printer.

Printing Pictures

Direct printing (PictBridge)

By connecting the camera to a PictBridge-compatible printer with the USB cable, you can print out recorded pictures directly.

Before connecting, select [Print] for [USB Connection] (P. 63) in the setting menu.

Connecting the camera

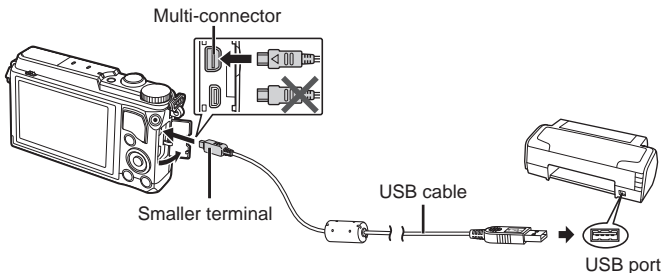

- Use a fully charged battery for printing.
- Movies cannot be printed.

■ Easy printing

1 Use ◀▶ to display the pictures you want to print on the camera.

2 Connect the camera to the printer using the supplied USB cable.

- If the easy print start screen is not displayed, select [Print] for [USB Connection] (P. 63) in the setting menu before connecting the printer again.

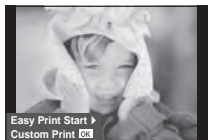

3 Press \triangleright .

- The picture selection screen appears when printing is completed. To print another picture, use $\triangleleft \triangleright$ to select the image and press OK .
- To exit, unplug the USB cable from the camera while the picture selection screen is displayed.

■ Custom printing

1 Connect the camera to the printer using the supplied USB cable and turn the camera on.

- When the camera is turned on, a dialog should be displayed in the monitor prompting you to choose a host. If it is not, select [Print] for [USB Connection] (P. 63) in the setting menu.

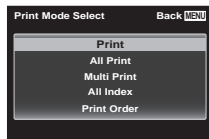

2 Follow the operation guide to set a print option.

Selecting the print mode

Select the type of printing (print mode). The available print modes are as shown below.

Print	Prints selected pictures.
All Print	Prints all the pictures stored in the card and makes one print for each picture.
Multi Print	Prints multiple copies of one image in separate frames on a single sheet.
All Index	Prints an index of all the pictures stored in the card.
Print Order	Prints according to the print reservation you made (P. 78). If there is no picture with print reservation, this is not available.

Setting the print paper items

This setting varies with the type of printer. If only the printer's STANDARD setting is available, you cannot change the setting.

Size	Sets the paper size that the printer supports.
Borderless	Selects whether the picture is printed on the entire page or inside a blank frame.
Pics/sheet	Selects the number of pictures per sheet. Displayed when you have selected [Multi Print].

Selecting pictures you want to print

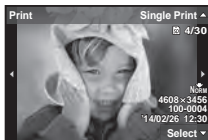

Select pictures you want to print. The selected pictures can be printed later (single-frame reservation) or the picture you are displaying can be printed right away.



Print (OK)	Prints the currently displayed picture. If there is a picture that [Single Print] reservation has already been applied to, only that reserved picture will be printed.
Single Print (▲)	Applies print reservation to the currently displayed picture. If you want to apply reservation to other pictures after applying [Single Print], use <◀▶> to select them.
More (▼)	Sets the number of prints and other items for the currently displayed picture, and whether or not to print it. For operation, refer to "Setting printing data" in the next section.

Setting printing data

Select whether to print printing data such as the date and time or file name on the picture when printing.

	Sets the number of prints.
Date	Prints the date and time recorded on the picture.
File Name	Prints the file name recorded on the picture.
	Trims the picture for printing. Set the trimming size with the zoom lever (T/W), and set the trimming position with $\Delta \nabla \triangleleft \triangleright$.

3 Once you have set the pictures for printing and printing data, select [Print], then press $\textcircled{\text{OK}}$.

- To stop and cancel printing, press $\textcircled{\text{OK}}$. To resume printing, select [Continue].

■ Cancelling printing

To cancel printing, highlight [Cancel] and press $\textcircled{\text{OK}}$. Note that any changes to the print order will be lost; to cancel printing and return to the previous step, where you can make changes to the current print order, press **MENU**.

Print reservation (DPOF)

In print reservations, the number of prints and date imprint option are saved in the image on the card. This enables easy printing at a printer or print shop supporting DPOF by using only the print reservations on the card without a computer or a camera.

- Print reservations can be set only for the images stored on the card.
- DPOF reservations set by another DPOF device cannot be changed by this camera. Make changes using the original device. Making new DPOF reservations with this camera will erase the reservations made by the other device.
- DPOF print reservations can be made for up to 999 images per card.

■ Single-frame print reservations []

1 Display the setup menu.

- “Using the setup menu” (P. 47)

2 From the playback menu [▶], select [Print Order] and then press the (OK) button.

3 Use Δ ∇ to select [], and press the (OK) button.

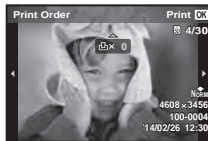

4 Use ◀ ▶ to select the image for print reservation. Use Δ ∇ to select the quantity. Press the (OK) button.

5 Use Δ ∇ to select the [⌚] (date print) screen option, and press the (OK) button.

Submenu 2	Application
No	This prints the image only.
Date	This prints the image with the shooting date.
Time	This prints the image with the shooting time.

6 Use Δ ∇ to select [Set], and press the (OK) button.

■ Reserving one print each of all images on the card [

1 Follow Steps 1 and 2 in [] (P. 78).

2 Use $\Delta \nabla$ to select [], and press the  button.

3 Follow Steps 5 and 6 in [].

■ Resetting all print reservation data



1 Follow Steps 1 and 2 in [] (P. 78).

2 Select either [] or [], and press the  button.

3 Use $\Delta \nabla$ to select [Reset], and press the  button.

■ Resetting the print reservation data for selected images



1 Follow Steps 1 and 2 in [] (P. 78).

2 Use $\Delta \nabla$ to select [], and press the  button.

3 Use $\Delta \nabla$ to select [Keep] and press the  button.

4 Use $\triangleleft \triangleright$ to select the image with the print reservation you want to cancel. Use $\Delta \nabla$ to set the print quantity to "0".

5 If necessary, repeat Step 4, and then press the  button when finished.

6 Use $\Delta \nabla$ to select the [] (date print) screen option, and press the  button.

- The settings are applied to the remaining images with the print reservation data.

7 Use $\Delta \nabla$ to select [Set], and press the  button.

Connecting the camera to a computer

Connecting the camera

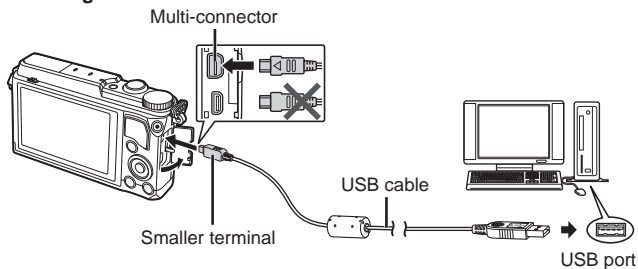

- ! If nothing is displayed on the camera screen even after connecting the camera to the computer, the battery may be exhausted. Use a full-charged battery.
- ! If the camera cannot connect to PC, disconnect the USB cable and check the setting of [USB Connection] (P. 63) before connecting to PC again.
- The battery can be charged while the camera is connected to the computer via USB. The charging time varies depending on the performance of the computer. (There may be cases in which it takes approx. 10 hours.)

Copying pictures to a computer

Your camera supports the USB Mass Storage Class. You can transfer images to a computer by connecting the camera to the computer with the provided USB cable. The following operating systems are compatible with the USB connection:

Windows	Windows XP SP3 / Windows Vista SP2 / Windows 7 SP1 / Windows 8 / Windows 8.1
Macintosh	Mac OS X v10.5-v10.9

- 1** Turn the camera off and connect it to the computer.
 - The location of the USB port varies with the computer. For details, refer to your computer's manual.
- 2** The computer recognizes the camera as a new device.
 - ! If your computer is running Windows Vista / Windows 7 / Windows 8 / Windows 8.1, select [MTP] in [USB Connection] of the setting menu to use Windows Photo Gallery.
 - ! Data transfer is not guaranteed in the following environments, even if your computer is equipped with a USB port.
 - Computers with a USB port added by means of an extension card, etc.
 - Computers without a factory-installed OS and home-built computers
 - ! Camera controls can not be used while the camera is connected to a computer.
 - ! If the dialog is not displayed when the camera is connected, set [USB Connection] (P. 63) of the setting menu before connecting to PC again.

Installing Software

■ Windows

1 Insert the supplied CD in a CD-ROM drive.

Windows XP

- A “Setup” dialog will be displayed.

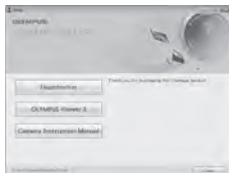

Windows Vista / Windows 7 / Windows 8 / Windows 8.1

- An Autorun dialog will be displayed. Click “OLYMPUS Setup” to display the “Setup” dialog.

! If the “Setup” dialog is not displayed, select “My Computer” (Windows XP) or “Computer” (Windows Vista/Windows 7) from the start menu. Double-click the CD-ROM (OLYMPUS Setup) icon to open the “OLYMPUS Setup” window and then double-click “LAUNCHER.EXE”.

! If a “User Account Control” dialog is displayed, click “Yes” or “Continue”.

2 Follow the on-screen instructions on your computer.

3 Register your Olympus product.

- Click the “Registration” button and follow the on-screen instructions.

4 Install OLYMPUS Viewer 3.

- Check the system requirements before beginning installation.
- Click the “OLYMPUS Viewer 3” button and follow the on-screen instructions to install the software.

Operating System	Windows XP SP3/Windows Vista SP2/ Windows 7 SP1/Windows 8 / Windows 8.1
Processor	Pentium 4 1.3 GHz or better (Core 2 Duo 2.13 GHz or better required for movies)
RAM	1 GB or more (2 GB or more recommended)
Free Hard Drive Space	3 GB or more
Monitor Settings	1024 × 768 pixels or more Minimum 65,536 colors (16,770,000 colors recommended)

- See online help for information on using the software.

■ Macintosh

1 Insert the supplied CD in a CD-ROM drive.

- The disk contents should automatically be displayed in the Finder. If they are not, double-click the CD icon on the desktop.
- Double-click the “Setup” icon to display the “Setup” dialog.



2 Install OLYMPUS Viewer 3.

- Check the system requirements before beginning installation.
- Click the “OLYMPUS Viewer 3” button and follow the on-screen instructions to install the software.



Operating System	Mac OS X v10.5–v10.9
Processor	Intel Core Solo/Duo 1.5 GHz or better (Core 2 Duo 2 GHz or better required for movies)
RAM	1 GB or more (2 GB or more recommended)
Free Hard Drive Space	3 GB or more
Monitor Settings	1024 × 768 pixels or more Minimum 32,000 colors (16,770,000 colors recommended)

- Other languages can be selected from the language combo box. For information on using the software, see online help.

Usage Tips

If the camera does not work as intended, or if an error message is displayed on the screen, and you are unsure of what to do, refer to the information below to fix the problem(s).

Troubleshooting

■ Battery

The camera does not work even when batteries are installed.

- Insert recharged batteries in the correct direction.  “Inserting and removing the battery and card” (P. 4)
- Battery performance may have been reduced temporarily due to low temperature. Take the batteries out of the camera, and warm them by putting them in your pocket for a while.



■ Card

An error message is displayed.

-  “Error message” (P. 86)

■ Shutter button

No picture is taken when the shutter button is pressed.

- Cancel sleep mode.
To save battery power, the camera automatically goes into sleep mode and the monitor turns off if there is no operation for 3 minutes when the camera is turned on. No picture is taken even if the shutter button is fully pressed in this mode. Operate the zoom lever or other buttons to restore the camera from sleep mode before taking a picture. If the camera is left for another 12 minutes, it automatically turns off. Press the **ON/OFF** button to turn the camera on.
- Press the  button to switch to the shooting mode.
- Wait until  (flash charge) stops blinking before taking pictures.
- With prolonged camera use, the internal temperature may increase, resulting in automatic shutdown. If this occurs, wait until the camera has sufficiently cooled.

The camera's external temperature may also increase during use, however this is normal and does not indicate malfunction.

■ Monitor

Difficult to see.

- Condensation may have occurred. Turn off the power, and wait for the camera body to become acclimated to the surrounding temperature and dry out before taking pictures.

The light is caught in the picture.

- Shooting with flash in dark situations results in an image with many flash reflections on dust in the air.













■ Date and time function

Date and time settings return to the default setting.

- If the batteries are removed and left out of the camera for about 3 days^{*1}, the date and time settings return to the default setting, and must be reset.
 - *1 The time until the date and time settings return to the default setting varies depending on how long the batteries have been loaded.
-  "Turning on the camera and making the initial settings" (P. 8)









Error message

- When one of the messages below is displayed on the monitor, check the corrective action.

Error message	Corrective action
 Card Error	Card problem Insert a new card.
 Write Protect	Card problem The card write-protect switch is set to the "LOCK" side. Release the switch.
 Memory Full	Internal memory problem <ul style="list-style-type: none">Insert a card.Erase unwanted images.^{*1}
 Card Full	Card problem <ul style="list-style-type: none">Replace the card.Erase unwanted images.^{*1}
	Card problem Use Δ ∇ to select [Format], and press the  button. Next, use Δ ∇ to select [Yes], and press the  button. ^{*2}
	Internal memory problem Use Δ ∇ to select [Memory Format], and press the  button. Next, use Δ ∇ to select [Yes], and press the  button. ^{*2}
 No Picture	Internal memory/Card problem Take pictures before viewing them.
 Picture Error	Problem with selected image Use photo retouch software, etc. to view the image on a computer. If the image still cannot be viewed, the image file is corrupted.

^{*1} Before erasing important images, download them to a computer.

^{*2} All data will be erased.

Error message	Corrective action
 The Image Cannot Be Edited	Problem with selected image Use photo retouch software, etc. to edit the image on a computer.
 Battery Empty	Battery problem Charge the battery.
 No Connection	Connection problem Connect the camera and computer or printer correctly.
 No Paper	Printer problem Load paper into the printer.
 No Ink	Printer problem Refill the ink in the printer.
 Jammed	Printer problem Remove the jammed paper.
Settings Changed ^{*3}	Printer problem Return to the status where the printer can be used.
 Print Error	Printer problem Turn off the camera and printer, check the printer for any problems, and then turn the power on again.
 Cannot Print ^{*4}	Problem with selected image Use a computer to print.

^{*3} This is displayed, for instance, when the printer's paper tray has been removed. Do not operate the printer while making the print settings on the camera.





^{*4} This camera may be unable to print images taken by other cameras.

Shooting tips

When you are unsure of how to take a picture that you envision, refer to the information below.

■ Focusing

Focusing on the subject.

- **Taking a picture of a subject not in the center of the monitor.**  P. 38
After focusing on an object at the same distance as the subject, compose the shot, and take the picture.
- **Set [AF Mode] to [Face/iESP].**  P. 50
- **Taking a picture in [AF Tracking] mode.**  P. 50
The camera tracks the subject movement automatically to focus on it continuously.
- **Taking a picture of a shadowy subject.**  P. 52
Using the AF illuminator makes focusing easier.
- **Taking a picture of subjects where autofocus is difficult.**
In the following cases, after focusing on an object (by pressing the shutter button halfway down) with high contrast at the same distance as the subject, compose the shot, and take the picture.

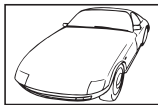

Subject with low contrast



Excessively bright light in center of frame

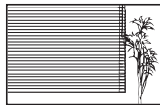

Subject containing no vertical lines^{*1}



Subjects at different distances^{*1}

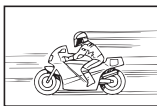

Fast-moving subject







Subject not inside AF area

^{*1} It is also effective to compose the shot by holding the camera vertically to focus, and then returning to the horizontal position to take the picture.







■ Camera shake

Taking pictures without camera shake.

- **Taking pictures using [Image Stabilizer].**  P. 52
The camera detects camera movement to reduce the blur even if the ISO sensitivity is not increased. This function is also effective when taking pictures at a high zoom magnification.
- **Shooting movies using [IS Movie Mode].**  P. 55
- **Select [Sport] in the scene mode.**  P. 26
The [Sport] mode uses a fast shutter speed and can reduce the blur incurred by a moving subject.
- **Taking pictures at a high ISO sensitivity.**  P. 42
If a high ISO sensitivity is selected, pictures can be taken at a high shutter speed even at locations where a flash cannot be used.

■ Exposure (brightness)

Taking pictures with the right brightness.

- **Taking pictures of a subject against a backlight**
Faces or backgrounds are bright even when shot against backlight.
[Shadow Adjust]  P. 58
[Backlight HDR]  P. 26
- **Taking pictures using [Face/iESP].**  P. 50
Appropriate exposure is obtained for a face against backlight, and the face is brightened.
- **Taking pictures using [Spot Metering].**  P. 51
Brightness is matched with a subject in the center of the screen and the image is not affected by background light.
- **Taking pictures using [Fill In] flash.**  P. 35
A subject against backlight is brightened.
- **Taking pictures of a white beach or snow scene.**  P. 26
Select [Beach & Snow] in the scene mode.
- **Taking pictures using exposure compensation.**  P. 36
Adjust the brightness while viewing the screen for taking the picture. Normally, taking pictures of white subjects (such as snow) results in images that are darker than the actual subject. Use the exposure compensation to adjust in the positive (+) direction to express whites as they appear. When taking pictures of black subjects, on the other hand, it is effective to adjust in the negative (-) direction.

■ Color hue

Taking pictures with colors at the same shade as they appear.

- **Taking pictures by selecting white balance.**  P. 42

Best results in most environments can normally be obtained with the [WB Auto] setting, but for some subjects, you should try experimenting with different settings. (This is especially true for sunshade under a clear sky, mixed natural and artificial light settings, and so on.)

■ Image quality

Taking sharper pictures.

- **Taking pictures with the optical zoom or super-resolution zoom.**

Avoid using digital zoom (P. 51) to take pictures.

- **Taking pictures at a low ISO sensitivity.**  P. 42

If the picture is taken with a high ISO sensitivity, noise (small colored spots and color unevenness that were not in the original image) can occur, and the image can appear grainy.

Playback/Editing tips

■ Playback

Playing images in the internal memory and card.

- **Remove the card and display the images in internal memory.**  P. 4

Viewing images with high picture quality on a highdefinition TV.

- **Connect the camera to the TV using an HDMI cable.**  P. 72

■ Editing

Erasing the sound recorded to a still image.

- **Record over the sound with silence when playing back the image.**
 P. 58

Cleaning and storing the camera

Camera care

Exterior:

- Wipe gently with a soft cloth. If the camera is very dirty, soak the cloth in water and wring well. Wipe the camera with the damp cloth and then dry it with a dry cloth. If you have used the camera at the beach, use a cloth soaked in clean water and well wrung.

Monitor:

- Wipe gently with a soft cloth.

Lens:

- Blow dust off the lens with a commercial blower, then wipe gently with a lens cleaner.
- ! Do not use strong solvents such as benzene or alcohol, or a chemically treated cloth.
- ! Mold may form on the lens surface if the lens is left dirty.

Battery/USB-AC adapter:

- Wipe gently with a soft, dry cloth.

Storage

- When storing the camera for extended periods, remove the battery, adapter and card, and keep in a cool, dry place that is well ventilated.
- Periodically insert the battery and test the camera functions.
- ! Avoid leaving the camera in places where chemical products are handled since this may result in corrosion.

Using a separately sold USB-AC adapter

The USB-AC adapter F-3AC (sold separately) can be used with this camera. Do not use any USB-AC adapter other than the dedicated one. When using F-3AC, be sure to use the USB cable included with this camera.

Do not use any other USB-AC adapter with this camera.

Using a separately sold charger

A charger (UC-90: sold separately) can be used to charge the battery.

Using your charger and USB-AC adapter abroad

- The charger and USB-AC adapter can be used in most home electrical sources within the range of 100 V to 240 V AC (50/60Hz) around the world. However, depending on the country or area you are in, the AC wall outlet may be shaped differently and the charger and USB-AC adapter may require a plug adapter to match the wall outlet. For details, ask at your local electrical shop or travel agent.
- Do not use travel voltage converters as they could damage your charger and USB-AC adapter.

Using the card

Cards compatible with this camera

SD/SDHC/SDXC/Eye-Fi (with Wireless LAN function) card
(commercially available)
(for compatibility card details, visit the Olympus website.)



- This camera can be used without a card by storing images in its internal memory.

Eye-Fi card

- The Eye-Fi card may become hot during use.
- When using an Eye-Fi card, the battery may run out faster.
- When using an Eye-Fi card, the camera may function more slowly.

SD/SDHC/SDXC card write-protect switch

The SD/SDHC/SDXC card body has a write-protect switch.

If you set the switch to the “LOCK” side, you will not be able to write to the card, delete data or format. Return the switch to enable writing.



Format

Cards must be formatted with this camera before first use or after being used with other cameras or computers.

Checking the image saving location

The memory indicator shows whether the internal memory or card is being used during shooting and playback.

Current memory indicator

: Internal memory is being used

: Card is being used

- ❗ Even if [Memory Format]/[Format], [Erase], [Sel. Image], [All Erase], or [Erase Group] is performed, the data in the card is not completely erased. When disposing of the card, damage the card to prevent the disclosure of personal data.
- ❗ Switching between a card and internal memory is not available. When using the internal memory, remove the card first.

Readout/recording process of the card

During shooting, the current memory indicator lights up in red while the camera is writing data. Never open the battery/card cover or unplug the USB cable. This can not only damage the image data but also render the internal memory or card unusable.

Number of storable pictures (still images)/Recording length (movies) in the internal memory and cards

! The figures for the number of storable still pictures and recording length are approximate. The actual capacity varies with shooting conditions and the card used.

Still pictures¹

Image Size	Compression	Number of storable pictures	
		Internal memory	SD/SDHC/SDXC card (4GB)
16M 4608×3456	FINE	4	460
	NORM	8	880
8M 3200×2400	FINE	9	900
	NORM	16	1,630
3M 1920×1440	FINE	27	2,740
	NORM	54	5,480
VGA 640×480	FINE	198	20,110
	NORM	341	30,170

¹ Examples of image size when the aspect ratio is 4:3.

Movies

Image Size	Recording length			
	Internal memory		SD/SDHC/SDXC card (4GB)	
	With sound	Without sound	With sound	Without sound
1080i 1920×1080 ¹	9 sec.	9 sec.	18 min.	18 min.
1080p 1920×1080 ¹	14 sec.	15 sec.	27 min.	29 min.
720p 1280×720 ¹	27 sec.	30 sec.	51 min.	57 min.
VGA 640×480	1 min. 6 sec.	1 min. 28 sec.	125 min.	167 min.
HS 120fps 1280×720 ²	—	11 sec.	—	21 min.
HS 240fps 432×324 ²	—	17 sec.	—	32 min.

¹ The recording length is up to 29 minutes in the HD quality specified.

² The recording length is up to 20 sec. in the HS quality specified.

- The maximum file size of a single movie is 4GB, regardless of the capacity of the card.

Increasing the number of pictures that can be taken

Either erase unwanted images, or connect the camera to a computer or other device to save the images, and then erase the images in the internal memory or card.

[Erase] (P. 15, 61), [Sel. Image], [All Erase], [Erase Group] (P. 61), [Memory Format]/[Format] (P. 62)

List of settings available in each shooting mode

For the available settings of **SCN** and **ART**, refer to “List of **SCN** settings” (P. 98) and “List of **ART** settings” (P. 99).

	P	i AUTO			M		
Picture Mode	✓	—	—	—	✓	—	*1
Flash	✓	*1	*1	—	*1	*1	—
Exposure Comp.	✓	—	✓	✓	—	—	✓
White balance	✓	—	✓	✓	✓	—	✓
ISO	✓	—	✓	—	*1	—	—
 /🔄	✓	*1	—	*1	*1	*1	*1
Image size (still images)	✓	✓	—	—	✓	✓	*1
Aspect	✓	✓	—	—	✓	✓	—
Image size (movies)	✓	*1	—	*1	✓	*1	*1
Shutter speed	—	—	—	—	✓	—	—
Aperture value	—	—	—	—	✓	—	—
Compression	✓	✓	✓	✓	✓	✓	*1
Shadow Adjust	✓	—	—	—	✓	—	*1
Touch Shutter	✓	✓	—	✓	✓	✓	*1
AF Mode	✓	—	—	*1	✓	—	*1
ESP/ 	✓	—	✓	✓	✓	—	*1
Digital Zoom	✓	—	—	—	✓	—	*1
Image Stabilizer	✓	✓	✓	✓	✓	—	—
AF Illuminat.	✓	—	✓	—	✓	✓	*1
Rec View	✓	✓	—	✓	✓	✓	*1
Pic Orientation	✓	✓	✓	✓	✓	✓	*1
Date Stamp	✓	✓	—	—	✓	✓	*1
Super-Res Zoom	✓	—	—	—	✓	—	*1
IS Movie Mode	✓	✓	—	✓	✓	✓	*1
	✓	✓	—	✓	✓	✓	*1
Wind Noise Setting	✓	✓	—	✓	✓	✓	*1

*1 Some functions cannot be set.

List of SCN settings

Picture Mode	—	—	—	✓	—	—	—	—	—	—	—	—	—	—	—	—
Flash	*1	*1	—	✓	—	*1	*1	*1	*1	—	—	*1	—	*1	—	—
Exposure Comp.	—	—	—	✓	—	—	—	—	—	—	—	—	—	—	—	—
White balance	—	—	—	✓	—	—	—	—	—	—	—	—	—	—	—	—
ISO	—	—	—	✓	—	—	—	—	—	—	—	—	—	—	—	—
	*1	*1	*1	—	*1	*1	✓	*1	*1	*1	*1	*1	*1	*1	✓	*1
Image size (still images)	✓	✓	✓	✓	✓	✓	✓	✓	✓	✓	✓	✓	✓	✓	✓	✓
Aspect	✓	✓	✓	✓	✓	✓	✓	✓	✓	✓	✓	✓	✓	✓	✓	✓
Image size (movies)	*1	*1	*1	*1	*1	*1	*1	*1	*1	*1	*1	*1	*1	*1	✓	*1
Shutter speed	—	—	—	—	—	—	—	—	—	—	—	—	—	—	—	—
Aperture value	—	—	—	—	—	—	—	—	—	—	—	—	—	—	—	—
Compression	✓	✓	✓	✓	✓	✓	✓	✓	✓	✓	✓	✓	✓	✓	✓	✓
Shadow Adjust	✓	✓	✓	✓	—	—	✓	✓	✓	✓	—	✓	✓	✓	✓	—
Touch Shutter	✓	✓	✓	✓	✓	✓	✓	✓	✓	✓	✓	✓	✓	✓	✓	✓
AF Mode	✓	—	✓	*1	✓	✓	✓	✓	—	✓	—	✓	✓	✓	—	✓
ESP/	—	—	—	—	—	—	—	—	—	—	—	—	—	—	—	—
Digital Zoom	✓	✓	✓	✓	✓	✓	✓	—	✓	—	✓	✓	✓	—	—	—
Image Stabilizer	✓	✓	✓	—	✓	✓	✓	✓	✓	✓	✓	✓	✓	✓	✓	✓
AF Illuminat.	✓	✓	✓	✓	✓	✓	✓	✓	✓	—	✓	✓	✓	—	✓	—
Rec View	✓	✓	✓	—	✓	✓	✓	✓	✓	✓	✓	✓	✓	✓	✓	✓
Pic Orientation	✓	✓	✓	✓	✓	✓	✓	✓	✓	✓	✓	✓	✓	✓	✓	✓
Date Stamp	✓	✓	✓	✓	✓	✓	✓	✓	✓	✓	✓	✓	✓	✓	✓	✓
Super-Res Zoom	—	—	—	—	—	—	—	—	—	—	—	—	—	—	—	—
IS Movie Mode	✓	✓	✓	✓	✓	✓	✓	✓	✓	✓	✓	✓	✓	✓	✓	✓
	✓	✓	✓	✓	✓	✓	✓	✓	✓	✓	✓	✓	✓	✓	✓	✓
Wind Noise Setting	✓	✓	✓	✓	✓	✓	✓	✓	✓	✓	✓	✓	✓	✓	✓	✓

*1 Some functions cannot be set.

List of ART settings

	Pop Art	Soft Focus	Pale&Light Color	Grainy Film	Pin Hole	Diorama	Dramatic Tone
Picture Mode	—	—	—	—	—	—	—
Flash	✓	✓	✓	✓	✓	✓	✓
Exposure Comp.	✓	✓	✓	✓	✓	✓	✓
White balance	✓	✓	✓	—	✓	✓	✓
ISO	—	—	—	—	—	—	—
	*1	*1	*1	*1	*1	*1	*1
Image size (still images)	✓	✓	✓	✓	✓	✓	✓
Aspect	✓	✓	✓	✓	✓	✓	✓
Image size (movies)	*1	*1	*1	*1	*1	*1	*1
Shutter speed	—	—	—	—	—	—	—
Aperture value	—	—	—	—	—	—	—
Compression	✓	✓	✓	✓	✓	✓	✓
Shadow Adjust	—	—	—	—	—	—	—
Touch Shutter	✓	✓	✓	✓	✓	✓	✓
AF Mode	✓	✓	✓	✓	✓	✓	✓
ESP/ 	✓	✓	✓	✓	✓	✓	✓
Digital Zoom	—	—	—	—	—	—	—
Image Stabilizer	✓	✓	✓	✓	✓	✓	✓
AF Illuminat.	✓	✓	✓	✓	✓	✓	✓
Rec View	✓	✓	✓	✓	✓	✓	✓
Pic Orientation	✓	✓	✓	✓	✓	✓	✓
Date Stamp	—	—	—	—	—	—	—
Super-Res Zoom	—	—	—	—	—	—	—
IS Movie Mode	✓	✓	✓	✓	✓	✓	✓
	✓	✓	✓	✓	✓	—	✓
Wind Noise Setting	✓	✓	✓	✓	✓	—	✓

*1 Some functions cannot be set.

SAFETY PRECAUTIONS



CAUTION
RISK OF ELECTRICAL SHOCK
DO NOT OPEN



CAUTION: TO REDUCE THE RISK OF ELECTRICAL SHOCK, DO NOT REMOVE COVER (OR BACK). NO USER-SERVICEABLE PARTS INSIDE. REFER SERVICING TO QUALIFIED OLYMPUS SERVICE PERSONNEL.



An exclamation mark enclosed in a triangle alerts you to important operating and maintenance instructions in the documentation provided with the product.



DANGER

If the product is used without observing the information given under this symbol, serious injury or death may result.



WARNING

If the product is used without observing the information given under this symbol, injury or death may result.



CAUTION

If the product is used without observing the information given under this symbol, minor personal injury, damage to the equipment, or loss of valuable data may result.

WARNING!
TO AVOID THE RISK OF FIRE OR ELECTRICAL SHOCK, NEVER DISASSEMBLE, EXPOSE THIS PRODUCT TO WATER OR OPERATE IN A HIGH HUMIDITY ENVIRONMENT.

Power Source — Connect this product only to the power source described on the product label.

Lightning — If a lightning storm occurs while using a USB-AC adapter, remove it from the wall outlet immediately.

Foreign Objects — To avoid personal injury, never insert a metal object into the product.

Heat — Never use or store this product near any heat source such as a radiator, heat register, stove, or any type of equipment or appliance that generates heat, including stereo amplifiers.

General Precautions

Read All Instructions — Before you use the product, read all operating instructions. Save all manuals and documentation for future reference.

Cleaning — Always unplug this product from the wall outlet before cleaning. Use only a damp cloth for cleaning. Never use any type of liquid or aerosol cleaner, or any type of organic solvent to clean this product.

Attachments — For your safety, and to avoid damaging the product, use only accessories recommended by Olympus.

Water and Moisture — For precautions on products with weatherproof designs, read the weatherproofing sections.

Location — To avoid damage to the product, mount the product securely on a stable tripod, stand, or bracket.

Handling the Camera



WARNING

- Do not use the camera near flammable or explosive gases.
- Do not use the flash and LED (including AF illuminator) on people (infants, small children, etc.) at close range.
- You must be at least 1 m (3 ft.) away from the faces of your subjects. Firing the flash too close to the subject's eyes could cause a momentary loss of vision.

- **Keep young children and infants away from the camera.**
- Always use and store the camera out of the reach of young children and infants to prevent the following dangerous situations which could cause serious injury:
 - Becoming entangled in the camera strap, causing strangulation.
 - Accidentally swallowing the battery, cards or other small parts.
 - Accidentally firing the flash into their own eyes or those of another child.
 - Accidentally being injured by the moving parts of the camera.
- **Do not look at the sun or strong lights with the camera.**
- **Do not use or store the camera in dusty or humid places.**
- **Do not cover the flash with a hand while firing.**
- **Use SD/SDHC/SDXC memory cards or Eye-Fi cards only. Never use other types of cards.**
If you accidentally insert another type of card into the camera, contact an authorized distributor or service center. Do not try to remove the card by force.
- **If you find that the USB-AC adapter is extremely hot or notice any unusual odors, noise, or smoke around it, unplug the power plug from wall outlet immediately and stop using it. Then, contact an authorized distributor or service center.**

CAUTION

- **Stop using the camera immediately if you notice any unusual odors, noise, or smoke around it.**
 - Never remove the batteries with bare hands, which may cause a fire or burn your hands.
- **Never hold or operate the camera with wet hands.**
- **Do not leave the camera in places where it may be subject to extremely high temperatures.**
 - Doing so may cause parts to deteriorate and, in some circumstances, cause the camera to catch fire. Do not use the charger or USB-AC adapter if it is covered (such as a blanket). This could cause overheating, resulting in fire.
- **Handle the camera with care to avoid getting a low-temperature burn.**
 - When the camera contains metal parts, overheating can result in a low-temperature burn. Pay attention to the following:
 - When used for a long period, the camera will get hot. If you hold on to the camera in this state, a low-temperature burn may be caused.
 - In places subject to extremely cold temperatures, the temperature of the camera's body may be lower than the environmental temperature. If possible, wear gloves when handling the camera in cold temperatures.
- **Be careful with the strap.**
 - Be careful with the strap when you carry the camera. It could easily catch on stray objects and cause serious damage.
- To protect the high-precision technology contained in this product, never leave the camera in the places listed below, no matter if in use or storage:
 - Places where temperatures and/or humidity are high or go through extreme changes. Direct sunlight, beaches, locked cars, or near other heat sources (stove, radiator, etc.) or humidifiers.
 - In sandy or dusty environments.
 - Near flammable items or explosives.
 - In wet places, such as bathrooms or in the rain. When using products with weatherproof designs, read their manuals as well.
 - In places prone to strong vibrations.
- Never drop the camera or subject it to severe shocks or vibrations.
- When attaching the camera to or removing it from a tripod, rotate the tripod screw, not the camera.
- Before transporting the camera, remove a tripod and all other non-OLYMPUS accessories.
- Do not touch electric contacts on cameras.
- Do not leave the camera pointed directly at the sun. This may cause lens or shutter curtain damage, color failure, ghosting on the image pickup device, or may possibly cause fires.
- Do not push or pull severely on the lens.
- Before storing the camera for a long period, remove the batteries. Select a cool, dry location for storage to prevent condensation or mold from forming inside the camera. After storage, test the camera by turning it on and pressing the shutter button to make sure that it is operating normally.
- The camera may malfunction if it is used in a location where it is subject to a magnetic/ electromagnetic field, radio waves, or high voltage, such as near a TV set, microwave, video game, loud speakers, large monitor unit, TV/radio tower, or transmission towers. In such cases, turn the camera off and on again before further operation.
- Always observe the operating environment restrictions described in the camera's manual.

Battery Handling Precautions

Follow these important guidelines to prevent batteries from leaking, overheating, burning, exploding, or causing electrical shocks or burns.

DANGER

- The camera uses a lithium ion battery specified by Olympus. Charge the battery with the specified USB-AC adapter or charger. Do not use any other USB-AC adapters or chargers.
- Never incinerate or heat batteries in microwaves, on hot plates, or in pressure vessels, etc.
- Never leave the camera on or near electromagnetic devices.
This may cause overheating, burning, or exploding.
- Do not connect terminals with any metallic objects.
- Take precautions when carrying or storing batteries to prevent them from coming into contact with any metal objects such as jewelry, pins, fasteners, etc. The short circuit may cause overheating, exploding, or burning, which burn or damage you.
- Never store batteries where they will be exposed to direct sunlight, or subjected to high temperatures in a hot vehicle, near a heat source, etc.
- To prevent causing battery leaks or damaging their terminals, carefully follow all instructions regarding the use of batteries. Never attempt to disassemble a battery or modify it in any way, solder, etc.
- If battery fluid gets into your eyes, flush your eyes immediately with clear, cold running water and seek medical attention immediately.
- Always store batteries out of the reach of small children and pets. If they accidentally swallow a battery, seek medical attention immediately.
- If you cannot remove the battery from the camera, contact an authorized distributor or service center. Do not try to remove the battery by force. Damage to the battery exterior (scratches, etc.) may produce heat or an explosion.

WARNING

- Keep batteries dry at all times.
- To prevent batteries from leaking, overheating, or causing a fire or explosion, use only batteries recommended for use with this product.
- Insert the battery carefully as described in the operating instructions.
- If rechargeable batteries have not been recharged within the specified time, stop charging them and do not use them.
- Do not use a battery if it is cracked or broken.
- If a battery leaks, has unusual odor, becomes discolored or deformed, or becomes abnormal in any other way during operation, stop using the camera, and keep away from fire immediately.

- If a battery leaks fluid onto your clothing or skin, remove the clothing and flush the affected area with clean, running cold water immediately. If the fluid burns your skin, seek medical attention immediately.
- Never subject batteries to strong shocks or continuous vibration.
This may cause exploding, overheating, or burning.

CAUTION

- Before loading, always inspect the battery carefully for leaks, discoloration, warping, or any other abnormality.
- The battery may become hot during prolonged use. To avoid minor burns, do not remove it immediately after using the camera.
- Always unload the battery from the camera before storing the camera for a long period.
- This camera uses one Olympus lithium ion battery. Use the designated battery.
There is a risk of explosion if the battery is replaced with the incorrect battery type.
- Power consumption by the camera varies depending on which functions are used.
- During the conditions described below, power is consumed continuously and the battery becomes exhausted quickly.
 - The zoom is used repeatedly.
 - The shutter button is pressed halfway repeatedly in shooting mode, activating the auto focus.
 - A picture is displayed on the monitor for an extended period of time.
 - The camera is connected to a printer.
- Using an exhausted battery may cause the camera to turn off without displaying the battery level warning.
- The Olympus lithium ion battery is designed to be used only for the Olympus digital camera. Do not use the battery to other devices.
- If the battery's terminals get wet or greasy, camera contact failure may result. Wipe the battery well with a dry cloth before use.
- Always charge a battery when using it for the first time, or if it has not been used for a long period.
- When operating the camera with battery power at low temperatures, try to keep the camera and spare battery as warm as possible. A battery that has run down at low temperatures may be restored after it is warmed at room temperature.
- Before going on a long trip, and especially before traveling abroad, purchase extra batteries. A recommended battery may be difficult to obtain while traveling.
- When storing the battery for a long period, select a cool location for storage.
- Please recycle batteries to help save our planet's resources. When you throw away dead batteries, be sure to cover their terminals and always observe local laws and regulations.

USB-AC adapter

- The included USB-AC adapter F-2AC is designed to be used only with this camera. Other cameras cannot be charged with this USB-AC adapter.
- Do not connect the included USB-AC adapter F-2AC to equipment other than this camera.
- For plug-in type USB-AC adapter:
The included USB-AC adapter F-2AC is intended to be correctly orientated in a vertical or floor mount position.

Use Only Dedicated Rechargeable Battery, Battery Charger and USB-AC adapter

We strongly recommend that you use only the genuine Olympus dedicated rechargeable battery, battery charger and USB-AC adapter with this camera. Using a non-genuine rechargeable battery, battery charger and/or USB-AC adapter may result in fire or personal injury due to leakage, heating, ignition or damage to the battery. Olympus does not assume any liability for accidents or damage that may result from the use of a battery, battery charger and/or USB-AC adapter that are not genuine Olympus accessories.

Precautions when using the wireless LAN function

WARNING

- **Turn off the camera in hospitals and other locations where medical equipment is present.**

The radio waves from the camera may adversely affect medical equipment, causing a malfunction that results in an accident.

- **Turn off the camera when onboard aircraft.**

Using wireless devices onboard may hinder safe operation of the aircraft.

Monitor

- Do not push the monitor forcibly; otherwise the image may become vague, resulting in a playback mode failure or damage to the monitor.
- A strip of light may appear on the top/bottom of the monitor, but this is not a malfunction.
- When a subject is viewed diagonally in the camera, the edges may appear zigzagged on the monitor. This is not a malfunction; it will be less noticeable in playback mode.
- In places subject to low temperatures, the monitor may take a long time to turn on or its color may change temporarily. When using the camera in extremely cold places, it is a good idea to occasionally place it in a warm place. The monitor exhibiting poor performance due to low temperatures will recover in normal temperatures.

- The monitor of this product is manufactured with high-quality accuracy, however, there may be a stuck or dead pixel on the monitor. These pixels do not have any influence on the image to be saved. Because of the characteristics, the unevenness of the color or brightness may also be found depending on the angle, but this is due to the structure of the monitor. This is not a malfunction.

Legal and Other Notices

- Olympus makes no representations or warranties regarding any damages, or benefit expected by using this unit lawfully, or any request from a third person, which are caused by the inappropriate use of this product.
- Olympus makes no representations or warranties regarding any damages or any benefit expected by using this unit lawfully which are caused by erasing picture data.

Disclaimer of Warranty

- Olympus makes no representations or warranties, either expressed or implied, by or concerning any content of these written materials or software, and in no event shall be liable for any implied warranty of merchantability or fitness for any particular purpose or for any consequential, incidental or indirect damages (including but not limited to damages for loss of business profits, business interruption and loss of business information) arising from the use or inability to use these written materials or software or equipment. Some countries do not allow the exclusion or limitation of liability for consequential or incidental damages or of the implied warranty, so the above limitations may not apply to you.
- Olympus reserves all rights to this manual.

Warning

Unauthorized photographing or use of copyrighted material may violate applicable copyright laws. Olympus assumes no responsibility for unauthorized photographing, use or other acts that infringe upon the rights of copyright owners.

Copyright Notice

All rights reserved. No part of these written materials or this software may be reproduced or used in any form or by any means, electronic or mechanical, including photocopying and recording or the use of any type of information storage and retrieval system, without the prior written permission of Olympus. No liability is assumed with respect to the use of the information contained in these written materials or software, or for damages resulting from the use of the information contained therein. Olympus reserves the right to alter the features and contents of this publication or software without obligation or advance notice.

FCC Notice

This equipment has been tested and found to comply with the limits for a Class B digital device, pursuant to part 15 of the FCC Rules. These limits are designed to provide reasonable protection against harmful interference in a residential installation. This equipment generates, uses and can radiate radio frequency energy and, if not installed and used in accordance with the instructions, may cause harmful interference to radio communications. However, there is no guarantee that interference will not occur in a particular installation. If this equipment does cause harmful interference to radio or television reception, which can be determined by turning the equipment off and on, the user is encouraged to try to correct the interference by one or more of the following measures:

- Reorient or relocate the receiving antenna.
- Increase the separation between the equipment and receiver.
- Connect the equipment into an outlet on a circuit different from that to which the receiver is connected.
- Consult the dealer or an experienced radio/TV technician for help.
- Only the OLYMPUS-supplied USB cable should be used to connect the camera to USB enabled personal computers.

FCC Caution

Changes or modifications not expressly approved by the party responsible for compliance could void the user's authority to operate the equipment.

This transmitter must not be co-located or operated in conjunction with any other antenna or transmitter.

The available scientific evidence does not show that any health problems are associated with using low power wireless devices. There is no proof, however, that these low power wireless devices are absolutely safe. Low power Wireless devices emit low levels of radio frequency energy (RF) in the microwave range while being used. Whereas high levels of RF can produce health effects (by heating tissue), exposure of low-level RF that does not produce heating effects causes no known adverse health effects. Many studies of low-level RF exposures have not found any biological effects. Some studies have suggested that some biological effects might occur, but such findings have not been confirmed by additional research. SH-1 has been tested and found to comply with FCC radiation exposure limits set forth for an uncontrolled environment and meets the FCC radio frequency (RF) Exposure Guidelines.

This equipment complies with IC radiation exposure limits set forth for an uncontrolled environment and meets RSS-102 of the IC radio frequency (RF) Exposure rules. This equipment has very low levels of RF energy that are deemed to comply without testing of specific absorption ratio (SAR).

For customers in North and South America

For customers in USA

Declaration of Conformity

Model Number: SH-1

Trade Name: OLYMPUS

Responsible Party:

OLYMPUS IMAGING AMERICA INC.

Address: 3500 Corporate Parkway,
P.O. Box 610, Center Valley,
PA 18034-0610, U.S.A.

Telephone Number: 484-896-5000

Tested To Comply With FCC Standards
FOR HOME OR OFFICE USE

This device complies with Part 15 of FCC Rules and Industry Canada licence-exempt RSS standard(s). Operation is subject to the following two conditions:

- (1) This device may not cause harmful interference.
- (2) This device must accept any interference received, including interference that may cause undesired operation.

For customers in CANADA

This Class B digital apparatus complies with Canadian ICES-003. CAN ICES-3(B)/NMB-3(B)

OLYMPUS WORLDWIDE LIMITED WARRANTY - IMAGING PRODUCTS

Olympus warrants that the enclosed Olympus® imaging product(s) and related Olympus® accessories (individually a "Product" and collectively the "Products") will be free from defects in materials and workmanship under normal use and service for a period of one (1) year from the date of purchase.

If any Product proves to be defective within the one-year warranty period, the customer must return the defective Product to any of Olympus Service Centers, following the procedure set forth below (See "WHAT TO DO WHEN SERVICE IS NEEDED").

Olympus, at its sole discretion, will repair, replace, or adjust the defective Product, provided that Olympus investigation and factory inspection disclose that (a) such defect developed under normal and proper use and (b) the Product is covered under this limited warranty.

Repair, replacement, or adjustment of defective Products shall be Olympus's sole obligation and the customer's sole remedy hereunder.

The customer is liable and shall pay for shipment of the Products to the Olympus Service Center.

Olympus shall not be obligated to perform preventive maintenance, installation, deinstallation, or maintenance.

Olympus reserves the right to (i) use reconditioned, refurbished, and/or serviceable used parts (that meet Olympus's quality assurance standards) for warranty or any other repairs and (ii) make any internal or external design and/or feature changes on or to its products without any liability to incorporate such changes on or to the Products.

WHAT IS NOT COVERED BY THIS LIMITED WARRANTY

Excluded from this limited warranty and not warranted by Olympus in any fashion, either express, implied, or by statute, are:

- (a) products and accessories not manufactured by Olympus and/or not bearing the "OLYMPUS" brand label (the warranty coverage for products and accessories of other manufacturers, which may be distributed by Olympus, is the responsibility of the manufacturers of such products and accessories in accordance with the terms and duration of such manufacturers' warranties);
- (b) any Product which has been disassembled, repaired, tampered with, altered, changed, or modified by persons other than Olympus's own authorized service personnel unless repair by others is made with the written consent of Olympus;
- (c) defects or damage to the Products resulting from wear, tear, misuse, abuse, negligence, sand, liquids, impact, improper storage, nonperformance of scheduled operator and maintenance items, battery leakage, use of non-"OLYMPUS" brand accessories, consumables, or supplies, or use of the Products in combination with non-compatible devices;
- (d) software programs;
- (e) supplies and consumables (including but not limited to lamps, ink, paper, film, prints, negatives, cables and batteries); and/or
- (f) Products which do not contain a validly placed and recorded Olympus serial number, unless they are a model on which Olympus does not place and record serial numbers.

EXCEPT FOR THE LIMITED WARRANTY SET FORTH ABOVE, OLYMPUS MAKES NO AND DISCLAIMS ALL OTHER REPRESENTATIONS, GUARANTIES, CONDITIONS, AND WARRANTIES CONCERNING THE PRODUCTS, WHETHER DIRECT OR INDIRECT, EXPRESS OR IMPLIED, OR ARISING UNDER ANY STATUTE, ORDINANCE, COMMERCIAL USAGE OR OTHERWISE, INCLUDING BUT NOT LIMITED TO ANY WARRANTY OR REPRESENTATION AS TO THE SUITABILITY, DURABILITY, DESIGN, OPERATION, OR CONDITION OF THE PRODUCTS (OR ANY PART THEREOF) OR THE MERCHANTABILITY OF THE PRODUCTS OR THEIR FITNESS FOR A PARTICULAR PURPOSE, OR RELATING TO THE INFRINGEMENT OF ANY PATENT, COPYRIGHT, OR OTHER PROPRIETARY RIGHT USED OR INCLUDED THEREIN.

IF ANY IMPLIED WARRANTIES APPLY AS A MATTER OF LAW, THEY ARE LIMITED IN DURATION TO THE LENGTH OF THIS LIMITED WARRANTY.

SOME STATES MAY NOT RECOGNIZE A DISCLAIMER OR LIMITATION OF WARRANTIES AND/OR LIMITATION OF LIABILITY SO THE ABOVE DISCLAIMERS AND EXCLUSIONS MAY NOT APPLY.

THE CUSTOMER MAY ALSO HAVE DIFFERENT AND/OR ADDITIONAL RIGHTS AND REMEDIES THAT VARY FROM STATE TO STATE.

THE CUSTOMER ACKNOWLEDGES AND AGREES THAT OLYMPUS SHALL NOT BE RESPONSIBLE FOR ANY DAMAGES THAT THE CUSTOMER MAY INCUR FROM DELAYED SHIPMENT, PRODUCT FAILURE, PRODUCT DESIGN, SELECTION, OR PRODUCTION, IMAGE OR DATA LOSS OR IMPAIRMENT OR FROM ANY OTHER CAUSE, WHETHER LIABILITY IS ASSERTED IN CONTRACT, TORT (INCLUDING NEGLIGENCE AND STRICT PRODUCT LIABILITY) OR OTHERWISE. IN NO EVENT SHALL OLYMPUS BE LIABLE FOR ANY INDIRECT, INCIDENTAL, CONSEQUENTIAL OR SPECIAL DAMAGES OF ANY KIND (INCLUDING WITHOUT LIMITATION LOSS OF PROFITS OR LOSS OF USE), WHETHER OR NOT OLYMPUS SHALL BE OR SHOULD BE AWARE OF THE POSSIBILITY OF SUCH POTENTIAL LOSS OR DAMAGE.

Representations and warranties made by any person, including but not limited to dealers, representatives, salespersons, or agents of Olympus, which are inconsistent or in conflict with or in addition to the terms of this limited warranty, shall not be binding upon Olympus unless reduced to writing and approved by an expressly authorized officer of Olympus.

This limited warranty is the complete and exclusive statement of warranty which Olympus agrees to provide with respect to the Products and it shall supersede all prior and contemporaneous oral or written agreements, understandings, proposals, and communications pertaining to the subject matter hereof.

This limited warranty is exclusively for the benefit of the original customer and cannot be transferred or assigned.

WHAT TO DO WHEN SERVICE IS NEEDED

The customer must transfer any image or other data saved on a Product to another image or data storage medium and/or remove any film from the Product prior to sending the Product to Olympus for service.

IN NO EVENT SHALL OLYMPUS BE RESPONSIBLE FOR SAVING, KEEPING OR MAINTAINING ANY IMAGE OR DATA SAVED ON A PRODUCT RECEIVED BY IT FOR SERVICE, OR ON ANY FILM CONTAINED WITHIN A PRODUCT RECEIVED BY IT FOR SERVICE, NOR SHALL OLYMPUS BE RESPONSIBLE FOR ANY DAMAGES IN THE EVENT ANY IMAGE OR DATA IS LOST OR IMPAIRED WHILE SERVICE IS BEING PERFORMED (INCLUDING, WITHOUT LIMITATION, DIRECT, INDIRECT, INCIDENTAL, CONSEQUENTIAL OR SPECIAL DAMAGES, LOSS OF PROFITS OR LOSS OF USE), WHETHER OR NOT OLYMPUS SHALL BE OR SHOULD BE AWARE OF THE POSSIBILITY OF SUCH POTENTIAL LOSS OR IMPAIRMENT.

Package the Product carefully using ample padding material to prevent damage in transit and either deliver it to the Authorized Olympus Dealer that sold you the Product or ship it postage prepaid and insured to any of our Olympus Service Centers.

When returning Products for service, your package should include the following:

- 1 Sales receipt showing date and place of purchase.
- 2 Copy of this limited warranty **bearing the Product serial number corresponding to the serial number on the Product** (unless it is a model on which Olympus does not place and record serial numbers).
- 3 A detailed description of the problem.
- 4 Sample prints, negatives, digital prints (or files on disk) if available and related to the problem.

When service is completed, the Product will be returned to you postage prepaid.

WHERE TO SEND PRODUCT FOR SERVICE

See "WORLDWIDE WARRANTY" for the nearest service center.

INTERNATIONAL WARRANTY SERVICE

International warranty service is available under this warranty.

For customers in Europe



"CE" mark indicates that this product complies with the European requirements for safety, health, environment and customer protection. "CE" mark cameras are intended for sales in Europe.

Hereby, Olympus Imaging Corp. and Olympus Europa SE & Co. KG declare that this SH-1 is in compliance with the essential requirements and other relevant provisions of Directive 1999/5/EC. For details visit: <http://www.olympus-europa.com/>



This symbol [crossed-out wheeled bin WEEE Annex IV] indicates separate collection of waste electrical and electronic equipment in the EU countries. Please do not throw the equipment into the domestic refuse.

Please use the return and collection systems available in your country for the disposal of this product.



This symbol [crossed-out wheeled bin Directive 2006/66/EC Annex II] indicates separate collection of waste batteries in the EU countries.

Please do not throw the batteries into the domestic refuse. Please use the return and collection systems available in your country for the disposal of the waste batteries.

Provisions of warranty

- 1 If this product proves to be defective, although it has been used properly (in accordance with the written Handling Care and Operating instructions supplied with it), during the applicable national warranty period and has been purchased from an authorized Olympus distributor within the business area of Olympus Europa SE & Co. KG as stipulated on the website: <http://www.olympus.com> this product will be repaired, or at Olympus's option replaced, free of charge. To claim under this warranty the customer must take the product before the end of the applicable national warranty period to the dealer where the product was purchased or any other Olympus service station within the business area of Olympus Europa SE & Co. KG as stipulated on the website: <http://www.olympus.com>.
During the one year period of the World Wide Guarantee the customer may turn the product in at any Olympus service station. Please notice that not in all countries such Olympus service station exists.
- 2 The customer shall transport the product to the dealer or Olympus authorized service station at his own risk and shall be responsible for any costs incurred in transporting the product.

Provisions of Guarantee

- 1 "OLYMPUS IMAGING CORP." grants a one year World Wide Guarantee. This worldwide Guarantee must be presented at an Olympus authorized repair service station before any repair can be made under conditions of this Guarantee. This Guarantee is valid only if the Guarantee Certificate and proof of purchase are presented at the Olympus repair service station. Please note that this Guarantee is in addition to and does not affect the customer's legal warranty rights under the applicable national legislation governing the sale of consumer goods mentioned above.
- 2 This Guarantee does not cover the following and the customer will be required to pay repair charge, even for defects occurring within the Guarantee period referred to above.
 - a. Any defect that occurs due to mishandling (such as an operation performed that is not mentioned in the Handling Care or other sections of the instructions, etc.)
 - b. Any defect that occurs due to repair, modification, cleaning, etc. performed by anyone other than Olympus or an Olympus authorized service station.
 - c. Any defect or damage that occurs due to transport, a fall, shock, etc. after purchase of the product.
 - d. Any defect or damage that occurs due to fire, earthquake, flood damage, thunderbolt, other natural disasters, environmental pollution and irregular voltage sources.

- e. Any defect that occurs due to careless or improper storage (such as keeping the product under conditions of high temperature and humidity, near insect repellents such as naphthalene or harmful drugs, etc.), improper maintenance, etc.
 - f. Any defect that occurs due to exhausted batteries, etc.
 - g. Any defect that occurs due to sand, mud, etc. entering the inside of the product casing.
 - h. When the Guarantee Certificate is not returned with the product.
 - i. When any alterations whatsoever are made to the Guarantee Certificate regarding the year, month and date of purchase, the customer's name, the dealer's name, and the serial number.
 - j. When proof of purchase is not presented with this Guarantee Certificate.
- 3** This Guarantee applies to the product only; the Guarantee does not apply to any other accessory equipment, such as the case, strap, lens cap and batteries.
- 4** Olympus's sole liability under this Guarantee shall be limited to repairing or replacing the product. Any liability under the Guarantee for indirect or consequential loss or damage of any kind incurred or suffered by the customer due to a defect of the product, and in particular any loss or damage caused to any lenses, films, other equipment or accessories used with the product or for any loss resulting from a delay in repair or loss of data, is excluded. Compelling regulations by law remain unaffected by this.

Notes regarding Guarantee maintenance

- 1** This Guarantee will only be valid if the Guarantee Certificate is duly completed by Olympus or an authorized dealer or other documents contain sufficient proof. Therefore, please make sure that your name, the name of the dealer, the serial number and the year, month and date of purchase are all completed or the original invoice or the sales receipt (indicating the dealer's name, the date of purchase and product type) is attached to this Guarantee Certificate. Olympus reserves the right to refuse free-of-charge service if neither Guarantee Certificate is completed nor the above document is attached or if the information contained in it is incomplete or illegible.
- 2** Since this Guarantee Certificate will not be issued, keep it in a safe place.
- * Please refer to the list on the web site: <http://www.olympus.com> for the authorized international Olympus service network.

For customers in Asia

Provisions of warranty

- 1** If this product proves to be defective, although it has been used properly (in accordance with the written Handling Care and Operating instructions supplied with it), during a period of up to one year from the date of purchase this product will be repaired, or at Olympus's option replaced, free of charge. To claim under warranty the customer must take the product and this Warranty certificate before the end of the one year warranty period to the dealer where the product was purchased or any Olympus authorized service station listed in the instructions and request the necessary repairs.
- 2** The customer shall transport the product to the dealer or Olympus authorized service station at his own risk and shall be responsible for any costs incurred in transporting the product.
- 3** This warranty does not cover the following and the customer will be required to pay repair charge, even for defects occurring within the one year period referred to above.
- a. Any defect that occurs due to mishandling (such as an operation performed that is not mentioned in the Handling Care or other sections of the instructions, etc.)
 - b. Any defect that occurs due to repair, modification, cleaning, etc. performed by anyone other than Olympus or an Olympus authorized service station.
 - c. Any defect or damage that occurs due to transport, a fall, shock, etc. after purchase of the product.
 - d. Any defect or damage that occurs due to fire, earthquake, flood damage, thunderbolt, other natural disasters, environmental pollution and irregular voltage sources.
 - e. Any defect that occurs due to careless or improper storage (such as keeping the product under conditions of high temperature and humidity, near insect repellents such as naphthalene or harmful drugs, etc.), improper maintenance, etc.
 - f. Any defect that occurs due to exhausted batteries, etc.
 - g. Any defect that occurs due to sand, mud, etc. entering the inside of the product casing.
 - h. When this Warranty Certificate is not returned with the product.
 - i. When any alterations whatsoever are made to the Warranty Certificate regarding the year, month and date of purchase, the customer's name, the dealer's name, and the serial number.
 - j. When proof of purchase is not presented with this Warranty Certificate.
- 4** This Warranty applies to the product only; the Warranty does not apply to any other accessory equipment, such as the case, strap, lens cap and batteries.

- 5 Olympus' sole liability under this warranty shall be limited to repairing or replacing the product and any liability for indirect or consequential loss or damage of any kind incurred or suffered by the customer due to a defect in the product, and in particular any loss or damage caused to any film or lenses or other equipment or accessories used with the product or for any loss resulting from delay in repair, is excluded.

For customers in Thailand

This telecommunication equipment conforms to NTC technical requirement.

For customer in Singapore

Complies with
IDA Standards
DB104634

Notes;

- 1 This Warranty is in addition to and does not affect the customer's statutory right.
- 2 If you have any queries regarding this Warranty, call any of the Olympus authorized service stations listed in the instructions.

Notes regarding warranty maintenance

- 1 This Warranty will only be valid if the Warranty Certificate is duly completed by Olympus or the dealer. Make sure that your name, the name of the dealer, the serial number and the year, month and date of purchase are all completed.
 - 2 Since this Warranty Certificate will not be re-issued, keep it in a safe place.
 - 3 Any request for repair by a customer in same country where the product was purchased shall be subject to the terms of the warranty issued by the Olympus distributor in that country. Where the local Olympus distributor does not issue a separate warranty or where the customer is not in the country where the product was purchased the terms of this worldwide warranty shall apply.
 - 4 Where applicable, this Warranty is valid worldwide. The Olympus authorized service stations listed in this Warranty will gladly honor it.
- * Please refer to the appended list for the authorized international Olympus service network.

Disclaimer of Warranty

Olympus makes no representations or warranties, either expressed or implied, by or concerning any content if these written materials or software, and in no event shall be liable for any implied warranty of merchantability or fitness for any particular purpose or for any consequential, incidental or indirect damages (including but not limited to damages for loss of business profits, business interruption and loss of business information) arising from the use of inability to use these written materials or software. Some states do not allow the exclusion or limitation of liability for consequential or incidental damages, so the above limitations may not apply to you.

Trademarks

- Microsoft and Windows are registered trademarks of Microsoft Corporation.
- Macintosh is a trademark of Apple Inc.
- SDXC logo is a trademark of SD-3C, LLC.
- Eye-Fi is a registered trademark of Eye-Fi, Inc.
- Wi-Fi is a registered trademark of the Wi-Fi Alliance.
- The Wi-Fi CERTIFIED logo is a certification mark of the Wi-Fi Alliance.
- Apical logo is a registered trademark of Apical Limited.
- All other company and product names are registered trademarks and/or trademarks of their respective owners.



THIS PRODUCT IS LICENSED UNDER THE AVC PATENT PORTFOLIO LICENSE FOR THE PERSONAL AND NONCOMMERCIAL USE OF A CONSUMER TO (i) ENCODE VIDEO IN COMPLIANCE WITH THE AVC STANDARD ("AVC VIDEO") AND/OR (ii) DECODE AVC VIDEO THAT WAS ENCODED BY A CONSUMER ENGAGED IN A PERSONAL AND NON-COMMERCIAL ACTIVITY AND/OR WAS OBTAINED FROM A VIDEO PROVIDER LICENSED TO PROVIDE AVC VIDEO. NO LICENSE IS GRANTED OR SHALL BE IMPLIED FOR ANY OTHER USE. ADDITIONAL INFORMATION MAY BE OBTAINED FROM MPEG LA, L.L.C. SEE [HTTP://WWW.MPEGLA.COM](http://www.MPEGLA.COM)

The software in this camera may include third party software. Any third party software is subject to the terms and conditions, imposed by the owners or licensors of that software, under which software is provided to you.

Those terms and other third party software notices, if any, may be found in the software notice PDF file stored within the accompanying CD-ROM or at <http://www.olympus.co.jp/en/support/imgs/digicamera/download/notice/notice.cfm>

- The standards for camera file systems referred to in this manual are the "Design rule for Camera File system/DCF" standards stipulated by the Japan Electronics and Information Technology Industries Association (JEITA).

Specifications

Camera

Product type	: Digital camera (for shooting and displaying)
Recording system	
Still pictures	: Digital recording, JPEG (in accordance with Design rule for Camera File system (DCF))
Applicable standards	: Exif 2.3, Digital Print Order Format (DPOF), PRINT Image Matching III, PictBridge
Sound with still pictures	: Wave format
Movie	: MOV H.264 linear PCM
Memory	: Internal memory, SD/SDHC/SDXC (supports UHS-I)/Eye-Fi card
No. of effective pixels	: 16,000,000 pixels
Image pickup device	: 1/2.3" CMOS (primary color filter)
Lens	: Olympus lens 4.5 to 108.0 mm, f3.0 to 6.9 (Equivalent to 25 to 600 mm on a 35 mm film)
Photometric system	: Digital ESP metering, spot metering system
Shutter speed	: 30 to 1/2000 sec.
Shooting range	
Normal	: 0.1 m (0.3 ft.) to ∞ (W), 0.4 m (1.3 ft.) to ∞ (T)
Super macro mode	: 0.03 m (0.01 ft.) to ∞ (f=14.3 mm (fixed))
Monitor	: 3.0" TFT color LCD display, touch screen, 460,000 dots
Connector	: Multi-connector (DC-IN jack, USB connector, A/V OUT jack)/HDMI micro connector (type D)
Automatic calendar system	: 2000 up to 2099
Operating environment	
Temperature	: 0 °C - 40 °C (32 °F - 104 °F) (operation)/ - 20 °C - 60 °C (- 4 °F - 140 °F) (storage)
Humidity	: 30% - 90% (operation)/10% - 90% (storage)

Power supply	: One Olympus lithium ion battery (LI-92B) or separately sold USB-AC adapter
Dimensions	: 108.8 mm (W) × 63.2 mm (H) × 42.4 mm (D) (4.3 × 2.5 × 1.7 in.) (excluding protrusions)
Weight	: 271 g (9.6 oz) (including battery and card)

Lithium ion battery (LI-92B)

Product type	: Lithium ion rechargeable battery
Model No.	: LI-92B
Standard voltage	: DC 3.6 V
Standard capacity	: 1350 mAh
Battery life	: Approx. 300 full charges (varies on usage)
Operating environment	
Temperature	: 0 °C to 40 °C (32 °F to 104 °F) (charging)

USB-AC adapter (F-2AC)

Model No.	: F-2AC-1B/F-2AC-2B
Power requirements	: AC 100 to 240 V (50/60 Hz)
Output	: DC 5 V, 500 mA
Operating environment	
Temperature	: 0 °C to 40 °C (32 °F to 104 °F) (operation)/ -20 °C to 60 °C (-4 °F to 140 °F) (storage)

Design and specifications subject to change without notice.

HDMI, the HDMI Logo and High-Definition Multimedia Interface are trademarks or registered trademarks of HDMI Licensing, LLC.

HDMI™
HIGH-DEFINITION MULTIMEDIA INTERFACE

OLYMPUS KOREA CO., LTD.

10F, Olympus Tower A, 114-9, Samsung-dong, Gangnam-gu, Seoul, Korea. 135-090
<http://www.olympus.co.kr> Tel. 1544-3200

OLYMPUS (MALAYSIA) Sdn Bhd

10-8, Menara 1 MK, Kompleks '1 Mont Kiara', No.1, Jalan Kiara, Mont Kiara, 50480
Kuala Lumpur, Malaysia.
Tel:+603-6411 0000/Fax:+603-6411 0003

BRANCHES:

PENANG OFFICE

Suite 3A-6, Level 3A, Wisma Great Eastern
No.25, Lebuhr Light, 10200 Penang
Tel:+604 262 2832/ Fax:+604 262 5832

<http://www.olympus.com.my>

OLYMPUS

<http://www.olympus.com/>

OLYMPUS IMAGING AMERICA INC.

3500 Corporate Parkway, P.O. Box 610, Center Valley, PA 18034-0610, U.S.A. Tel. 484-896-5000

Technical Support (U.S.A. / Canada)

24/7 online automated help:

<http://www.olympusamerica.com/support>

Phone customer support:

Tel. 1-800-260-1625 (Toll-free)

Our phone customer support is available from 9 am to 9 pm (Monday to Friday) ET

<http://olympusamerica.com/contactus>

Olympus software updates can be obtained at:

<http://www.olympusamerica.com/digital>

OLYMPUS EUROPA SE & CO. KG

Premises: Consumer Product Division

Wendenstrasse 14-18, 20097

Hamburg, Germany

Tel: +49 40-23 77 3-0 / Fax: +49 40-23 07 61

Goods delivery: Modul H, Willi-Bleicher Str. 36,
52353 Düren, Germany

Letters: Postfach 10 49 08, 20034 Hamburg,
Germany

European Technical Customer Support:

Please visit our homepage <http://www.olympus-europa.com> or call our TOLL FREE NUMBER* :
00800 - 67 10 83 00

for Austria, Belgium, Czech Republic, Denmark, Finland, France, Germany, Luxemburg,
Netherlands, Norway, Poland, Portugal, Russia, Spain, Sweden, Switzerland, United Kingdom.

* Please note some (mobile) phone services / provider do not permit access or request an
additional prefix to +800 numbers.

For all not listed European Countries and in case that you can't get connected to the above mentioned number,
please make use of the following CHARGED NUMBERS **+49 40 - 237 73 899**

OLYMPUS (CHINA) CO., LTD.

Customer Support: 400-650-0303 Homepage: <http://www.olympus-imaging.cn>

Customer Service Center:

A8F, Ping An International Financial Center, No. 1-3,

Xinyuan South Road, Chaoyang District, Beijing

Zip: 100027

Rm.1605-1608, Guangzhou International Electronic tower,

No403, Huan Shi East Road, Guang Zhou

Zip: 510095

A.32F Shanghai Industrial Investment Building 18

Cao Xi Road(N), Xuhui District, Shanghai

Zip: 200030

OLYMPUS HONG KONG AND CHINA LIMITED

Digital Camera Repair Centre

L4207, Office Tower, Langham Place, 8 Argyle Street, Mongkok, Kowloon, Hong Kong

Customer Hotline: +852-2376-2150 Fax: +852-2375-0630

<http://www.olympus.com.hk>