

acer

explore beyond limits™

Liquid | E2
Duo



© 2013 All Rights Reserved

Acer Liquid E2 Duo User's Manual

Model: V370

This revision: 5/2013

Acer Liquid E2 Duo Smartphone

Model number: _____

Serial number: _____

Date of purchase: _____

Place of purchase: _____

Table of contents

Table of contents	3
Setting up	5
Unpacking your smartphone	5
Getting to know your smartphone	5
Installing or removing the battery	6
Installing a SIM or microSD Card	8
Using your smartphone	9
Turning on for the first time	9
Locking your smartphone	9
Navigating through menus and options	10
Using the touchscreen	10
The Home screen	13
Managing contacts	19
Managing your contacts	19
Making calls	20
Before making a call	20
Making a call	20
The voice call screen	22
Internet calling	24
Adding an Internet calling account	24
Editing or removing an Internet calling account	24
Using Internet calling	24
Receiving Internet calls	24
Calling a contact's Internet calling address	24
Calling a phone number using Internet calling	24
Messaging	26
Creating a new message	26
Replying to a message	27
MMS messages	27
Going online	29
Browsing the Internet	29
Setting up your Google email	30
Composing an email	30
Setting up Email	30

Maps, Navigation, Places and Latitude	32
AcerCloud setup	34
AcerCloud setup for Windows	34
Using the Camera.	37
Camera icons and indicators	37
Taking a photo	39
Shooting a video	40
Viewing photos and videos	40
Geotagging	40
Advanced settings	41
Putting your smartphone in Airplane mode	41
Restarting your phone	41
Adjusting settings	41
Connecting to a PC	45
FM radio	46
Multimedia playback	46
Restoring to factory settings	47
Accessories and tips	48
Using the headset	48
Using a Bluetooth headset	48
Inserting a microSD Card	48
Appendix	49
FAQ and troubleshooting	49
Other sources of help	50
Warnings and precautions	50
Emergency calls	52
Taking care of your smartphone	52
Managing your SIM cards	54
Specifications	56
Safety	58
End User License Agreement	65

Setting up

Unpacking your smartphone

Your new smartphone comes packed in a protective box. Carefully unpack the box and remove the contents. If any of the following items is missing or damaged, contact your dealer immediately:

- Acer Liquid E2 Duo Smartphone
- Battery
- Quick Guide
- USB cable
- AC adapter
- Headset



Note: In-box content varies depending on country and region.

Getting to know your smartphone

Views

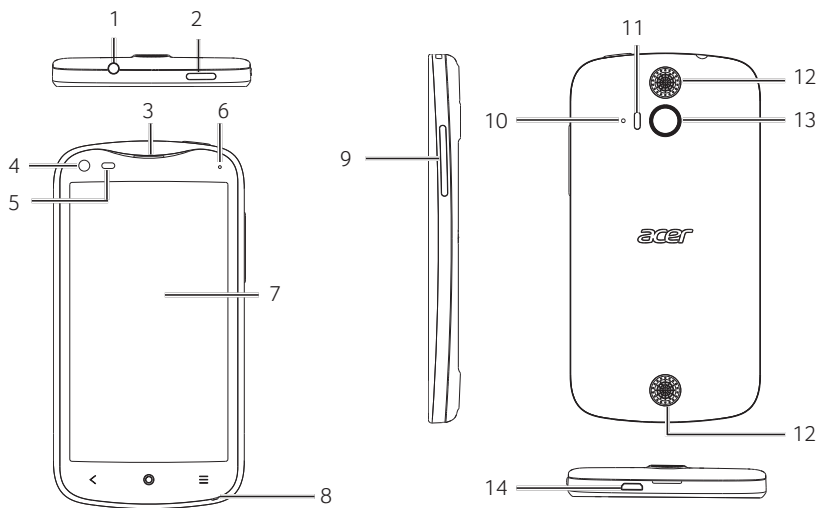

No.	Item	Description
1	3.5 mm headphone jack	Connects to stereo headphones.
2	Power button	Press to turn the screen on/off or enter sleep mode; press and hold to turn the smartphone on or off.
3	Phone speaker	Emits audio from your smartphone; suitable for holding to your ear.

No.	Item	Description
4	Front-facing camera	Useful for taking self portrait images.
5	Light sensor	Detects ambient light and automatically adjusts screen brightness.
6	LED indicator	Indicates the phone's charging status.
7	Touchscreen	4.5-inch, 960 x 540 pixel capacitive touchscreen to display data, phone content and enter information.
8	Microphone	Internal microphone.
9	Volume up/down buttons	Increases or decreases the phone volume.
10	Second microphone	For noise cancellation.
11	Flash	LED flash for camera.
12	Handsfree stereo speakers	Emit stereo audio from your smartphone; suitable for handsfree use.
13	Camera	A camera for taking high-resolution images.
14	Micro USB connector	Connects to a USB cable/charger.

LED Indicators

Status	Description
Blinks red every eight seconds	Low battery, not plugged in (only in sleep mode).
Blinks red every three seconds	Critically low battery, not plugged in (only in sleep mode).
Blinks red every two seconds	Bad battery or charging error.
Red	Charging.
Green	Fully charged, plugged in.
Blinks green every ten seconds	Missed call, voice mail, or new message (only in sleep mode).
Blue	Plugged in but not ready / not enough charge to power on. <i>Leave the device plugged in and try again later.</i>

Installing or removing the battery

Your smartphone uses a replaceable battery to provide power. It is packed separately from your smartphone and needs to be inserted and charged before you can use the smartphone.

Installing the battery

Insert your fingernail into the cutout between the battery cover and the phone. Unclip the cover and lift off the battery cover.

Place the battery into the battery compartment, lining up the battery connectors with those at the bottom of the compartment.

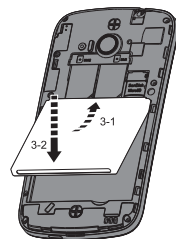

Align the tabs on the cover into the slots on the phone. Gently press the cover until it snaps in place.

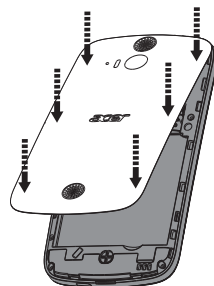

**CAUTION: RISK OF EXPLOSION IF BATTERY IS REPLACED BY AN INCORRECT TYPE.
DISPOSE OF USED BATTERIES ACCORDING TO THE INSTRUCTIONS.**

Charging the battery

For initial use, you need to charge your smartphone for eight hours. After that you can recharge the battery as needed.

Connect the AC adapter cord to the micro USB connector on your smartphone.

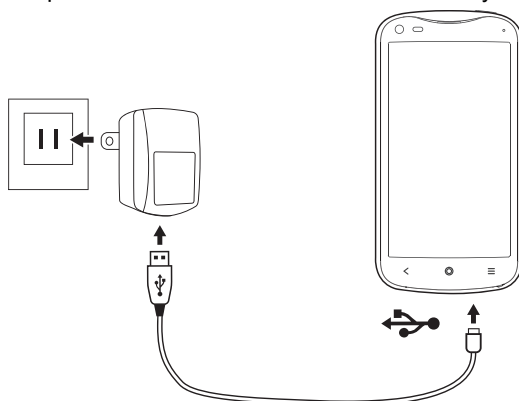

Removing the battery

Open the battery compartment as shown in **"Installing the battery"** on page 6. Lift the battery out of the compartment by lifting at the bottom of the battery.

Replace the battery cover as described above.

Installing a SIM or microSD Card

To take full advantage of your smartphone's telephony capabilities, you must install a SIM card. The SIM card holder is located at the top of the battery bay.

Your new phone has two SIM card holders, you may install one or two SIM cards.

Additionally, you may wish to increase your smartphone's storage by inserting a microSD Card into the slot provided. This is next to the SIM card slot.

1. Turn off the phone by pressing and holding the power button.
2. Open the cover and remove the battery as described in "**Removing the battery**" on page 7.
3. Insert the SIM or microSD Card as shown.
4. Replace the battery and battery cover.

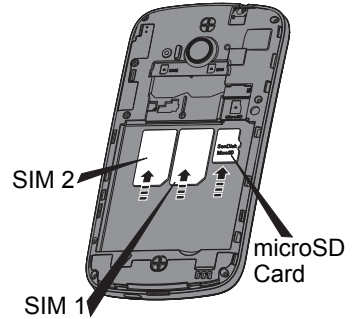

Note: Ensure that the microSD Card is inserted all the way into the card slot.

SIM card lock

Your smartphone may come with a SIM card lock, i.e., you will only be able to use the SIM card provided by your network operator.

To cancel the SIM lock, contact your network provider.

Using your smartphone

Turning on for the first time

To turn on your smartphone for the first time, press and hold the power button until the screen turns on. You will then be asked to configure some settings before you can use your smartphone.

Follow the onscreen instructions to complete setup.

Sign in to or create a Google account

If you have Internet access, your smartphone allows you to synchronize information with a google account.

During the start-up process, you may create or sign in to your account, which will be used to synchronize your contact list, email, calendar and other information. If you do not yet have Internet access, or do not want to use this feature, then tap **Skip**.

Creating multiple Google accounts

You can create and easily access multiple Google accounts. Open the **Application** menu and then tap **Settings > Add account**.

Entering your PIN

When you install a SIM card for the first time, you may need to enter a PIN using the onscreen number pad.



.....
Important: Depending on your settings, you may be required to enter your PIN each time you switch on the phone function.
.....

Activating a new SIM card

If you are using your SIM card for the first time, it may require activation. Contact your network operator for details on how to do this.

Locking your smartphone

If you will not use your smartphone for a while, briefly press the power button to lock access. This saves power and ensures your smartphone does not unintentionally use any services. Your smartphone will lock automatically if it is not used for one minute.

Waking your smartphone

If the screen is off and the smartphone does not react to any taps on the screen or front panel button, then it has been locked and is in sleep mode.

Press the power button to wake your smartphone. Unlock your smartphone by sliding your finger from one side of the screen to the other (it works both ways).

For additional security, you may set an unlock pattern, a set of dots that must be touched in the correct order to access the phone. Open the **Application** menu and then tap **Settings > Security > Screen lock**.

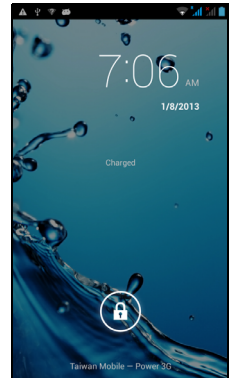

Note: If you forget your unlock pattern, please refer to "**Unlock pattern**" on page 50.

You may also directly enter the lock screen applications at the bottom of the screen. Tap the icon and slide your finger to the left or right across to quickly access the application. To change the lock screen applications, see "Managing the lock screen" on page 15.

Navigating through menus and options

To navigate through menus and options, there are three buttons beneath the screen.

Back



Back



Home



Menu

Tap this button to go to the previous page, or to go up one level in a menu. Tap and hold this button to see recently opened applications. Tap an application to open it, or tap anywhere on the screen to return to the Home screen. See "Multitasking" on page 18.

Home

Tap this button to go directly to the Home screen. Tap and hold this button to open the *Google Now* app. If you are not signed into your Google account, tap and hold this button to open the *Search* function.



Note: For information on *Google Now*, you may wish to view the Wikipedia page for the app at http://en.wikipedia.org/wiki/Google_Now.

Menu

Tap this button to open a menu of actions that are valid for the current application or screen.

Using the touchscreen

Your smartphone uses a touchscreen for selecting items and entering information. Use your finger to tap the screen.

Tap: Touch the screen once to open items and select options.

Drag: Hold your finger on the screen and drag across the screen to select text and images.

Tap and hold: Tap and hold an item to see a list of actions available for that item. On the pop-up menu that appears, tap the action you want to perform.

Scroll: To scroll up or down the screen, simply drag your finger up or down the screen in the direction that you want to scroll.

Android keyboard

This is a standard onscreen QWERTY keyboard that allows you to enter text. Tap and hold a key with numbers at the top to select alternative characters, such as letters with accents.

Tap the **?123** button to see numbers and special characters, and then tap the **ALT** key to see even more.

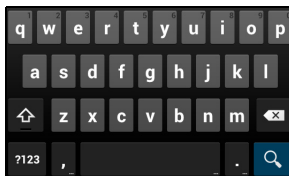

You can choose another input language by tapping and holding the comma key. Alternatively, you can open the **Application** menu and then tap **Settings > Language & input**. Then tap the **Settings** button next to "Android keyboard" > **Input languages**. The keyboard layout changes according to the selected language.

After setting up more than one language, the world button appears next to the space bar. Tap this button to quickly toggle between multiple input languages.



Text assistance

The Android keyboard has various features that assist you to enter correct text. In the **Application** menu, tap **Settings > Language & input** and then tap the **Settings** button to the right of **Android keyboard**. From here you can enable or disable several keyboard-related settings.

Changing the text input method

To change the input method, in the **Application** menu tap **Settings > Language & input > Default** and then select your preferred input method.

Predictive text

Both Swype and Android keyboard provide predictive text input for the browser. As you tap the letters of a word, a selection of words are displayed above the keyboard that continue the sequence of letters tapped, or are a close match allowing for errors. The word list changes after every key press. If the word you need is displayed, you can tap on it to insert it into your text.

Swype

Swype is a fast way to enter text. It allows you to type with one continuous motion across the screen keyboard; you create a word by drawing through letters.

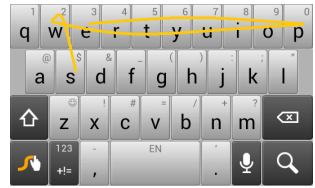

Put your finger on the first letter of the word and draw a path from letter to letter, lifting up only after the last letter. Swype will insert spaces where necessary.

Swype will usually add a double letter in a word when needed, but you can help Swype recognize you want a double letter by scribbling slightly or making a loop on the letter. For example, to get the "ll" in "hello", scribble (or make a loop) on the "l" key.

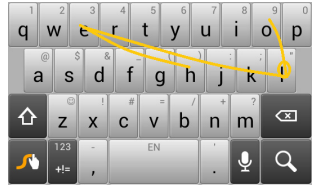

When there are multiple suggestions for the word you want to enter, Swype displays a Word Choice List. To accept the default word in the Word Choice List, just keep Swyping. Otherwise, scroll through the list by dragging your finger, and tap the word you want.

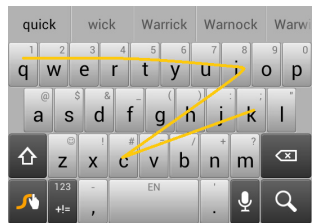

Press and hold the Swype key to access settings, features, updates, preferences, and help.



Tap the **+!=** button to see numbers and special characters; tap the page (shift) key to see even more.

Additional keys vary depending on the type of text you enter, e.g. a key to add a smiley is available when typing a text message. Like other keys, tap and hold for additional options.

To change the input method, open the **Notification** area (see "Status and notification area" on page 16.) and tap **Choose input method**.

Text assistance

The Swype keyboard has various features that assist you to enter correct text. In the **Application** menu, tap **Settings > Language & input** and then tap the **Settings** button to the right of **Swype**. You can also tap and hold the Swype key . From here you can enable or disable the following:

Function	Description
How to Swype	Learn how to use the Swype keyboard.
Preferences	Change your text input preferences.

Function	Description
Language Options	Set the language used by the keyboard.
Swype Connect	<ul style="list-style-type: none"> • Add contact names and words used in posts to your personal dictionary. • Change data settings.
Personal dictionary	Check words added you your personal dictionary.
Updates	Check for application and dictionary updates.

The Home screen

After rebooting, your smartphone will display the home screen. This screen gives you quick access to information and simple controls with widgets or shortcuts. These display information such as the time and weather, or provide additional controls and direct access to applications and other frequently used features of your smartphone.

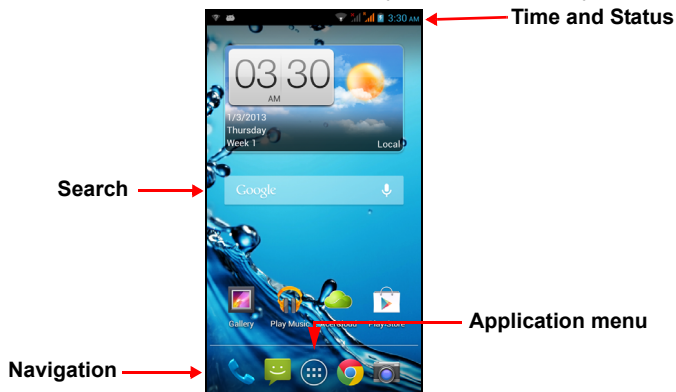

At the bottom of the screen is the **application dock** which displays default applications. Tap an icon to open the application. Tap the **Application** icon in the middle of the application dock to view your applications. To change applications, see "**Changing application dock icons**" on page 15.

Search

To search for applications, files or for information on the Internet, tap the **Google** widget in the middle of the screen.



Simply enter the text you want to find and tap  or tap one of the suggestions, applications or files shown in the list.

Voice search

If voice search is available, tap the microphone and speak your search request. See "Voice search" on page 29.



The extended Home screen

The Home screen extends to either side of the screen, giving you more room to add icons, widgets or features. To view the extended screen, slide your finger to the left or right.



Personalizing the Home screen

You may personalize your Home screen by adding or removing application shortcuts or widgets, and by changing the wallpaper.

Adding and removing shortcuts and widgets

To add shortcuts or widgets, tap the **Application** menu icon in the bottom-center of the Home screen.

Tap **APPS** to see a list of shortcuts to applications you can drag to a Home screen.

Tap **WIDGETS** to see small applications and links (such as custom shortcuts, contacts or bookmarks) that you can add to a Home screen. Widgets are small applications that display constantly-updated information or quick shortcuts to applications or special functions.

To move an App or Widget to the Home screen, tap and hold an item until it is selected. The Home screen will open. Drag the item to any free area on the screen. To view information about the App or Widget, drag it to the icon at the top of the screen.

To move the item to a different Home screen, drag it to the side of the screen, the Home screen will switch to the screen in that direction. Release the item when it is positioned correctly.

To remove a shortcut or widget from the Home screen, tap and drag it to **Remove** at the top of the screen.

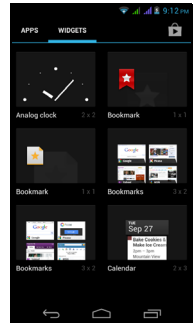

Resizing widgets

Some widgets can be resized. As soon as you place a widget on the Home screen, you can resize it by dragging the corners.

To resize a widget that is already on the Home screen, tap and hold the widget. Once the Remove icon appears, release the widget. If the widget is resizable, you will be able to drag the sides of the widget to resize it.

Adding or removing folders

You can also add folders to your Home screen. To create a new folder drag and drop an application icon onto another application icon in the Home screen. This will create an Unnamed Folder. Tap the folder icon and then tap the name of the folder to rename it.



To delete an application shortcut from a folder, tap on the folder icon to display the applications inside and then tap and hold the application icon that you want to remove. Drag and drop the icon on **Remove** that will appear at the top of the screen.

To delete a folder, tap and hold on the folder and then drag and drop the folder on **Remove** that will appear at the top of the screen.

Changing application dock icons

You can set icons for installed applications in the application dock. Open the **Application** menu and find the application you want to add. Tap and hold the icon, then drag it to any open position in the dock. Dragging the new application to an existing dock icon will create a folder for both icons.

To remove an icon from the dock, tap and hold the icon to select it. Either drag the icon to a different location outside the dock or to **Remove** at the top of the screen.

Changing the wallpaper

Tap and hold any open area on the Home screen. Tap the **Wallpaper** tab to change the lock screen and home wallpaper. You can choose from images stored in the Gallery, standard wallpapers, Live Wallpapers featuring animated or interactive backgrounds, or Video Wallpapers enabling you to use videos as your background.

Managing the lock screen

Tap and hold any open area on the Home screen. Tap the **Lock screen manager** tab to turn on and off lock screen icons or change which lock screen icons appear.

Changing home screen settings

Tap and hold any open area on the Home screen. Tap the **Home screen settings** tab to modify sliding effects. You can change the transition effect when scrolling to different screens. In addition, you can turn on and off automatic scrolling and cycle scrolling.

The Application menu

To access the Application menu, on the Home screen tap  in the center of the dock.

Applications are displayed in alphabetical order. Swipe the page to the left or right to see more applications. When you are on the last page of applications, swipe to the left to see widgets available on your tablet, or tap **WIDGETS** at the top of the page.

Tap the **Play Store** icon to open Google Play to view and purchase apps and/or digital media.

To quickly jump to applications or widgets, tap **APPS** or **WIDGETS** at the top of the Application menu.

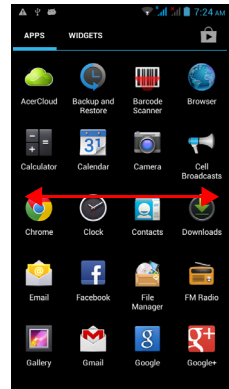

Note: All images are for reference only. The applications installed on your device can be different from the applications shown in illustrations.

Status and notification area

The Notification area is at the top of the screen.



This area contains a variety of icons to inform you of your phone's status. The left side of the Notification area displays event icons that indicate a new event (such as a new message). The icons on the right side indicate signal strength, connection, battery status and the time.

Drag the **Notification** area down the screen to view more information about new events adjust commonly used settings.

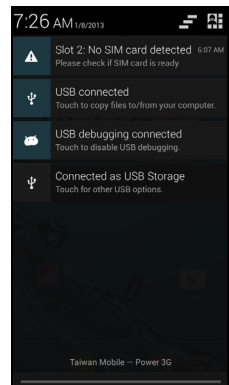

Connection icons



Note: Connection icons appear in different colors if you have two SIMs inserted.

Icon	Description	Icon	Description
	Connected to GPRS mobile network		Roaming
	Connected to EDGE mobile network		Cellular signal strength
	Connected to 3G mobile network		Mobile data transferring
	Connected to HSDPA network		Connected to a wireless network
	Bluetooth is on		No signal
	Bluetooth connected		Airplane mode (Wireless connectivity disconnected. Please disable airplane mode before trying to make a call.)
	USB and wireless tethering are activated		USB tethering is activated
	Wireless tethering is activated		

Battery icons























Icon	Description	Icon	Description
	Battery is very low		Battery is partially drained
	Battery is low		Battery is full
	Battery is charging		

Notification icons



Note: Notification icons appear in different colors if you have two SIMs inserted.

Icon	Description	Icon	Description
	Alarm is set		SIM card is invalid or not installed
	Speakerphone is on		Vibrate mode
	New Gmail message		Ringer is silenced

Icon	Description	Icon	Description
	New/unread SMS/MMS		Phone microphone is off
	Problem with sending SMS/MMS		Application update available
	New Google Talk message		System update available
	New voicemail		Missed call
	Upcoming event		Song is playing
	Syncing data		More notifications
	Warning, open the notification area for more information		GPS is on
	SD card or USB storage is full		Receiving location data from GPS
	An open wireless network is available		Uploading data
	Phone is connected to PC via USB		Downloading data
	Carrier data use threshold exceeded		Download finished
	Connected to or disconnected from virtual private network (VPN)		

Multitasking

You can have multiple applications open at the same time. To open a new application, tap the home button to return to the Home screen, then start the new application.

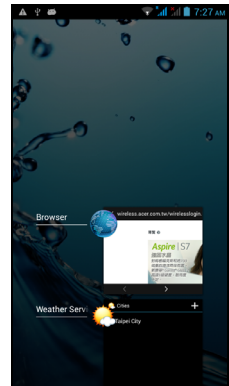

Tip: To prolong battery life, it is better to close an application when you've finished using it. Do this by either pressing the **Back** key or the **Menu** button and selecting **Exit** (if available).



Managing contacts

Managing your contacts

Your smartphone features an address book that allows you to save contacts to either the internal memory or onto your SIM card.

Open the **People** application from the Application menu or tap  from the Dialer to view your contacts.

If you don't have any contacts stored on your phone, you can import your Google account contacts, add a new contact or import contacts from your SIM or SD card. Open the **People** application from the Application menu and then

tap  to add a contact,  to search for a contact, or tap the **Menu** button to open the menu.

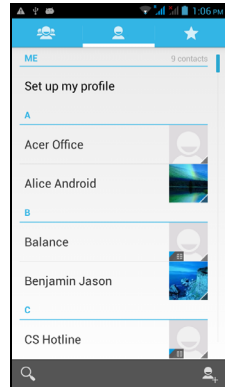

Adding a contact

Tap  to add a new contact. You may also scan a person's profile barcode to add the person to your contact list or group.

To create a contact, first choose where you want to store the contact's information. You will then be asked to enter the contact's information, such as name, address, and phone number.

You may scroll down the page and tap **Add another field** to add things such as:

- IM addresses.
- Add any personal notes about the contact.
- Phonetic name
- Link a website

To assign an image to your contact, tap the silhouette and select whether to take a photo or select an image from your smartphone's picture gallery.

When done, click **Done** at the top of the screen.

Tapping on the contacts name will bring up their profile. Tap

 while viewing a contact's profile to edit, share, delete, or print the contact. You may also set a ringtone for the contact, or associate the contact with a SIM card.

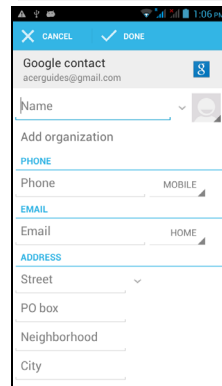
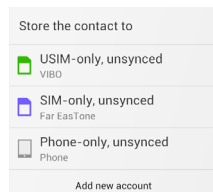

Tip: You may also create a contact from an already dialed or received number, see "**Saving a dialed number to contacts**" on page 23.

Making calls

This chapter shows you how to make phone calls, and the various options available to you during your call.

Before making a call

Check that the phone function is on before you make a call. You can confirm the phone status from the Notification area.



Note: Status and notification icon colors may vary.

Icon	Description
	Not connected to the network: You are unable to make a call.
	Connected to the network: You may make a call.
	Airplane mode: Wireless connectivity disconnected (Wi-Fi, Bluetooth, 2G and 3G). Please disable airplane mode before trying to make a call.

Making a call



Note: The phone function needs to be enabled before the call can be connected.

1. From the Home screen tap **Phone** to open the onscreen number pad.
2. Enter the number you wish to dial.
3. Tap to make the call.
4. To end the call, tap

If the contact you need is displayed, simply tap the contact name to make a call.

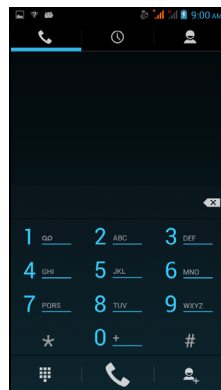



Dialing a number from Call Log

Your call history can be viewed by tapping the **Call Log** tab at the top of the screen. It displays recent received, dialed, and missed calls.

Tap the phone icon to redial. To view details of the call, tap the number or contact's name. While viewing the details of a call, tap the **Menu** button for other options: **Remove from call log**; **Edit number before call**.

Viewing missed calls

Missed call notifications are displayed in the following three areas:

1. The Notification area with the missed call  icon. Open the **Notification** area and tap the missed call notification to display the missed call details.
2. By the Phone icon  (the number in the box is the number of missed calls). Tap **Phone** from either the Home screen or the Application menu to directly display the missed call details.
3. On your phone's lock screen. Tap the notification and slide to the left or right to display the missed call details.

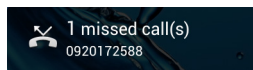

Making a call to one of your contacts

Calling a contact from the People tab

1. Tap the **People** tab at the top of the screen to view your contacts.
2. Tap on a contact to call them.

Calling a contact from the People application

1. Tap the **People** icon the Application menu to view your contacts.
2. Tap on a contact to open their profile.
3. Tap on the contact's phone number to call them.

Dialing an international number

When dialing international numbers, there is no need to enter the international direct dialing prefix ('00' etc.) before the country code. Simply tap and hold 0+ on the onscreen number pad until + appears onscreen.



.....
Warning: International call rates can vary greatly depending on the country you are calling and your network provider. We suggest you check all call rates with your network provider, to avoid excessive phone bills. If you are using your smartphone abroad, roaming charges will apply. Consult your network provider for roaming rates specific to the country you are visiting before you leave.

Direct dial widget

You may add a direct dial widget for a contact on your Home screen. Open the **Application** menu, then tap the **WIDGETS** tab. Tap and hold **Direct dial** and you will be able to place the widget on your Home screen. Once placed, you will be able to select a contact to associate with that particular widget on your Home screen.

The voice call screen

Once you have dialed your number the voice call screen appears, which displays the number/contact you are talking to, the call duration and voice call options.

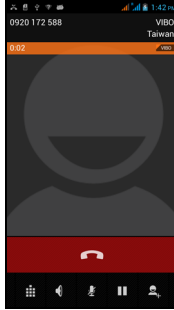

Answering or declining a call

When you have an incoming call, the number will be shown on the screen. To accept or decline the call, tap the appropriate icon and slide your finger across the screen.



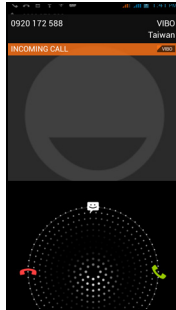

To decline the call with a text message, tap the  icon and select a message.



Ending a call

To end a call, tap  from the voice call screen.

Voice call options

Icon	Description
	Place the call on hold.
	Mute a call.
	Speakerphone.
	Access the keypad while a call is in progress.
	Two options: <ul style="list-style-type: none">• Add a second call• Record the conversation.



Saving a dialed number to contacts

You can save a number you have dialed to your contacts for future use.

1. Select the number from the **Call log** tab, and tap **Add to contacts** .
2. Tap **Create new contact** and select how to complete the action. See "**Adding a contact**" on page 19.

Conference calls

If you have one call on hold and another on line, you can combine both calls to create a conference call.

After the first call is established, tap  to add a second call. Tap  to start the conference call.

Internet calling

You can place and receive Internet calls over wireless network.

Adding an Internet calling account

From the Home screen tap **Phone** to open the onscreen number pad. Tap the **Menu** button and tap **Settings > Call settings > Internet Call**. Enable the *Use Internet calling* and tap **Accounts**.

Tap **Add account**, and input the **Username**, **Password**, and **Server** accounts. You can also configure optional settings such as Display name, Outbound proxy address, Port number, Transport type, and Send keep-alive.

Editing or removing an Internet calling account

Open an existing Internet calling account and make the edits you want on the SIP account details. Tap **Save** to save your changes, tap the **Menu** button and then tap **Discard** to discard the changes, or tap the **Menu** button and then select **Remove account** to delete the existing account.

Using Internet calling

You can configure your phone to use Internet calling (when you're connected to Wi-Fi) for all calls, only for Internet calls, or to ask each time you place a call.

Receiving Internet calls

You can configure your phone to receive Internet calls made to an Internet calling account you added to your phone. From the Home screen tap **Phone** to open the onscreen number pad. Tap the **Menu** button and tap **Settings > Call settings > Internet Call**. Enable the *Use Internet calling* and tap **Accounts**. Make sure the **Receive incoming calls** box is checked.

Calling a contact's Internet calling address

You must add an Internet calling address to a contact to be able to place an Internet call to them.

To make an Internet call, open **People** from your Home screen or in the Application menu. Tap on the contact to open their profile, and then tap on their Internet calling address to place the call.

Calling a phone number using Internet calling

If you have configured your phone to place all calls using Internet calling or to ask for each call, you may also call a phone number using Internet call, whenever you are connected to a wireless network.

Dial the number and tap , or select the contact you wish to place a call to, then tap the Internet call account you want to use to make the call.



.....
Important: Calling a phone number using Internet calling requires that your service provider supports it, and may incur additional charges. Please contact your service provider if you have any questions.
.....

Messaging

This chapter shows you how to set up and use the **Phone messages**, **Social messages** and **Social events** functions of your smartphone.

All SMS and MMS messages are accessed via **Messaging**. Messaging automatically arranges received and sent messages into threads.

To access Messaging tap **Messaging on the Home screen**.





Note: If you have two SIMs inserted in the phone, you will be asked which SIM to use before the message is sent. To select a SIM, just tap the name of the carrier.

Creating a new message

You can use your phone to compose Phone (SMS and MMS) messages.

Tap  to compose a new message.

Tap , or enter the recipient's phone number or name in the **To** field. Suggested contacts will be displayed in a drop-down list below the text field. To select a suggested contact, tap the contact's name. Once you've selected the desired contacts, tap  at the bottom of the screen.

Enter your message in the text box labeled **Type message**.

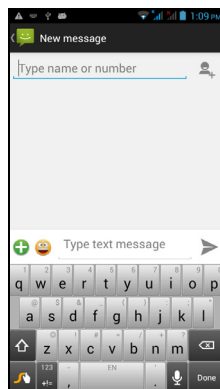

Note: SMS messages may be up to 160 characters long. If your message is longer than 160 characters, it will be sent as multiple linked messages. Most phones will automatically join the linked messages to present the recipient with a single long message, however, some older phones do not have this ability.

Tap the Menu button to see what options are available when creating a new message. The options change depending on the status of the message.

Option	Description
Add subject	Add a subject to the message.
Discard	Discard the message.
Insert quick text	Insert pre-defined text content.
Insert smiley	Insert a smiley/emoticon into your message text.
Insert contact	Add a contact to the recipients list.
Settings	Modify various messaging settings.

Replying to a message

When a new text message arrives a message icon appears in the Notification area and the message icon at the bottom of the phone displays the number of unread text messages.

Tap **Messaging** on the Home screen to view the message list or open the **Notification** area to see a summary of the message. Tap the summary to open the message list.

To reply to an SMS or MMS message, open the message from the message list. Enter your text in the text box labeled **Type message**. Tap the Menu button to see available options.

Option	Description
Add subject	Add a subject to the message.
Send	Send the message.
Delete messages	Deletes the message thread.
Insert quick text	Insert pre-defined text content.
Insert smiley	Insert a smiley/emoticon into your message text.
Insert contact	Add a contact to the recipients list.
Add to contacts	Add the other contact to your contacts list.
Settings	Modify various messaging settings.

MMS messages

MMS messages are similar to text messages but also allow you to attach multimedia files such as pictures, audio or video clips. Each MMS message can be up to 300 kB in size.

Note: You need to set up an MMS profile before you can send MMS messages. Normally, your smartphone will set up the profile for you based on information retrieved from your provider.
.....

Tip: Ask your network provider for the necessary information if you need to manually set up the MMS profile.
.....

Receiving MMS messages

When a new MMS message arrives, a message icon appears at the top of the screen and a notification message is displayed.

1. Open **Messaging** to view a summary of the message.
2. Tap **Download** to download the message content.



.....
Note: Downloads can take a long time, depending on your connection quality. If you reply or open another application, the download will be stopped.
.....



.....
Important: You may be charged to download message content, especially if you are roaming. Please contact your provider if you have any questions.
.....

3. Tap the message to view the content.
4. To reply to the message, enter **your text in the text box labeled Type message and tap the Send icon**. Simple text replies will be sent as SMS messages. If you wish to attach a file, tap . You will be presented with a menu of options.
5. When you have finished composing the message, tap the **Menu** button and tap **Send**.

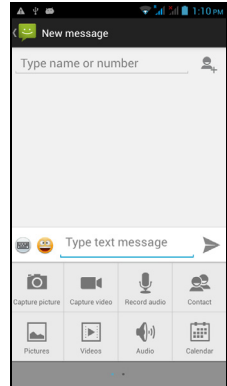

Going online

Browsing the Internet

In order to browse the Internet with your smartphone, you must be connected to a data or wireless network.

Using the browser

To start browsing, tap the **Chrome** icon on the Home screen, or open the Application menu and select **Chrome**. To open a new website, tap the address box at the top of the page. Enter the address using the keyboard and tap **Go**. You can zoom in or out of pages by pinching or reverse pinching.

To navigate forward and backward in your browser's history, view your bookmarks, adjust browser settings, and perform other tasks, tap the **Menu** button.

Chrome enables you to open multiple pages. Tap  at the top of any webpage to display all of your open tabs (tap again to close). Tap a tab from the list to open it. To open a new tab, tap **New tab**. The number in the icon represents the number of open tabs.

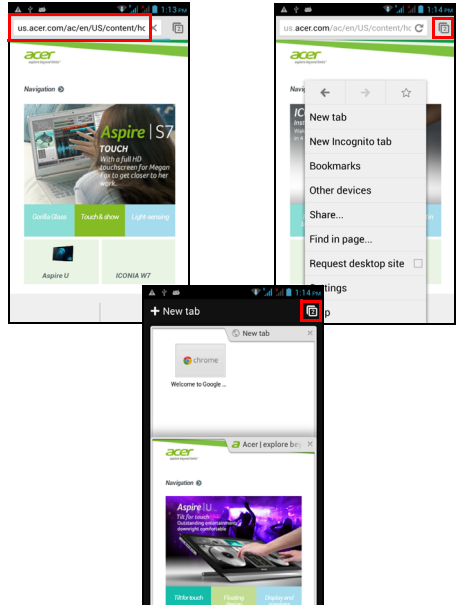

Voice search



Note: Voice search is available only in some regions.

With voice actions, you can send text messages, place calls, send emails, find directions of establishments, automatically call establishments, search the Internet

and even send a note to yourself using your voice. Open Voice Search from the Application menu, or tap  from the Home screen.

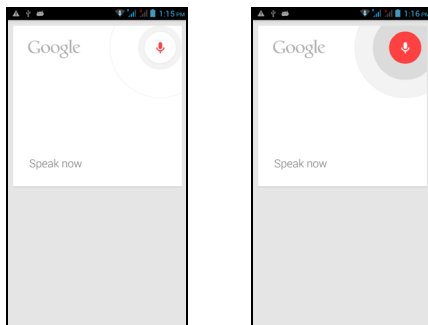



Setting up your Google email

1. Make sure your smartphone is connected to a data or Wi-Fi connection.
2. From the Application menu tap **Gmail**.

If you did not enter your Gmail account address and password when you first started your phone, follow the on screen instructions.

Composing an email

1. Make sure your smartphone is connected to a data or Wi-Fi connection.
2. From the Application menu tap **Gmail**.
3. Tap .
4. Enter the recipient's email address, the subject and message.
5. When you are finished composing your message, tap .

Setting up Email

Your smartphone enables you to access your email. Most popular ISPs can be set up in two steps. In the Application menu tap **Email** to start setting up your email account.

If necessary, enter your email address and tap **Manual setup** to enter the parameters manually. Tap **Next** to finish the setup process.

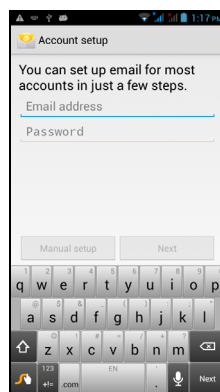

Google Play



Note: Google Play may not be available in all countries and regions.



Note: You must activate a Google account before using Google Play. The first time you access Google Play, you will need to read and accept the Terms of Service.

Tap **Play Store** from the Application menu to open the Google Play. Here you can obtain a variety of add-on programs and applications to enhance the functionality of your smartphone.



Note: The contents and design of Google Play varies by region. For example, in some regions, you can also browse for and purchase movies, books, magazines, or music. Updates may add new categories or change how to navigate Google Play at any time.

You can browse the store by category or tap the search icon to search for a specific application.

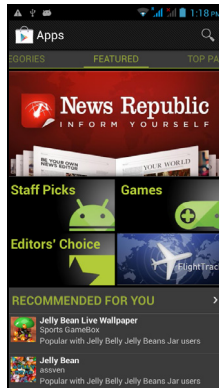

Once you have selected an application, tap the **Install** button to download and install the application. You will be told which services (contact information, wireless access, GPS, etc.) the application requires access in order to function correctly. If none of these services seem unusual, tap **Accept & download** to proceed with the installation.

You may keep track of the download progress from both the app's page and the smartphone's .

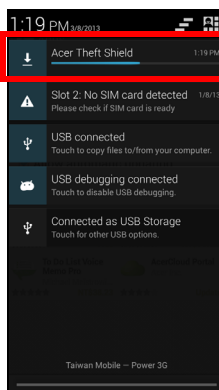
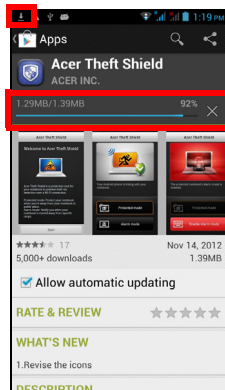

Important: Some applications may require payment before you can download them. You will need to have a Google Checkout account in order to pay for these applications, or a credit card number associated with your Google account.

Using downloaded applications

Once you've downloaded and installed an application, you may find it in the APPS or WIDGETS sections of the Application menu.

Certain applications provide both an App and widget, or only provide a widget (with no application icon). See **"Personalizing the Home screen" on page 14**.

Uninstalling downloaded applications

Once you've downloaded and installed an application, you may uninstall the application from the Application menu by pressing and holding the application icon and dragging it to the **Uninstall** trash can located at the top-left of the Home screen.



Note: Deleting an app from the Home screen only deletes the shortcut. See **"Adding and removing shortcuts and widgets" on page 14**.

Alternatively, you can go to **Settings** from the application menu and select **Apps**. Tap the application you wish to uninstall, tap **Uninstall** and confirm.

Maps, Navigation, Places and Latitude

Get easy-to-follow directions using Google Maps, view real-time traffic condition and navigate by using spoken, turn-by-turn driving instructions with Navigation, view where your friends are and places of interest and local businesses on Google Maps using Places and Latitude.



Important: Maps does not have information about every location.

Using the map

Tap the Maps icon in the applications menu. Drag the map with your finger to move the map around.

To zoom in or out:

1. Double tap a location on the map to zoom in on the location, and tap once to zoom out, or
2. Touch an area with two fingers at once and spread them apart to zoom in, and pinch them together to zoom out.



.....
Important: Not all zoom levels are available for all locations.
.....

AcerCloud setup

AcerCloud is a personal cloud service that allows you to access your files over the Internet, and make sure your most important files are always up to date. With your personal cloud all your devices (PC, tablet, phone) with AcerCloud installed can access files on your main Cloud PC. Open the **Application** menu and tap **AcerCloud**.

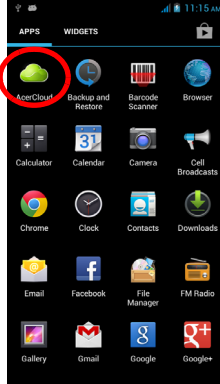

For more information please visit the AcerCloud website: www.acer.com/acercloud



Note: To access files on other devices, your Cloud PC must be on and connected to the Internet. If your PC has Always Connect, your PC may be in Sleep mode, but must be connected to a power supply (not battery power).

AcerCloud setup for Windows

To install AcerCloud on a PC without AcerCloud, you can download the AcerCloud setup program from the AcerCloud website (<https://www.cloud.acer.com/ops/downloads>) and select AcerCloud Installer in the Windows part.



Windows PC

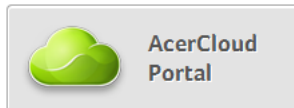

After download, double-click on the installer and follow the instructions to install AcerCloud.



Note: AcerCloud is designed for Windows 7 and Windows 8. It is not compatible with older Windows Operating Systems or MAC OS X.

Install AcerCloud

Double-click on the **AcerCloud** icon, then double-click on **AcerCloudSetup**. Follow the instructions to install AcerCloud.

Sign in using your Acer ID

Start the **AcerCloud** program from the desktop or Start Menu.

If you already have an Acer ID, use your email address and password to sign in to your AcerCloud account.



Create an AcerCloud ID

If you do not have an AcerCloud ID, you first need to sign up for an AcerCloud account, which you can do from your smartphone. Open the **Application** menu, tap **AcerCloud**, then tap **New to AcerCloud**, and enter the requested information

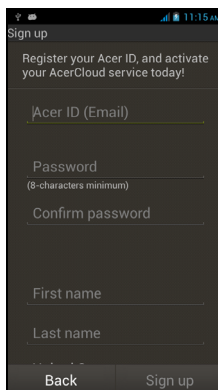
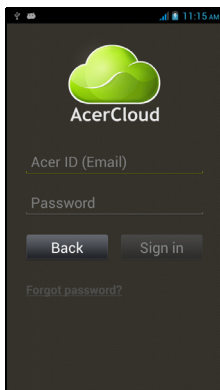

Make a note of the email address and password you used for your Acer Cloud ID. You must use this information to sign in to the AcerCloud service from each follow the instructions to register a new Acer ID.

After entering the information, tap **Next** to apply for an Acer ID. Check your email account for an Acer ID activation message and click on the link in the email to activate your Acer ID device.

AcerCloud options

When you install AcerCloud, you have several options. Select the options that are useful on your PC and click **Next** to complete the setup:



PicStream - Take holiday snapshots on your smartphone and share them with other smart devices. Photos will be backed up permanently on your Cloud PC (see below), and temporarily accessible for 30 days in your personal cloud and on other devices.

Make this PC the Cloud PC - You must define one (and only one) PC as your Cloud PC. Copies of all content added to your personal cloud (e.g. with PicStream) will be transferred to your Cloud PC, and content on this PC will be available to your other AcerCloud devices.



Important: If you already have a Cloud PC, do NOT select this option.

Your Cloud PC must be connected to the Internet and have sufficient storage for all your media content.

AcerCloud Docs Upload - When you update and save a document on your PC, the document will be put into the personal cloud and streamed to other devices. Documents will be temporarily accessible for 30 days in your personal cloud. You can download documents to other devices for long-term storage.



Note: If AcerCloud Docs Upload is not available, click on the AcerCloud icon in the notification area (the bottom-right corner of the Windows desktop) and select **Check for updates** to install AcerCloud Docs.



Note: You can access and change these AcerCloud settings from the AcerCloud icon in the Notification area (the bottom-right corner of the Windows desktop). Click on the AcerCloud icon, then select **Open AcerCloud** to see the settings window.

Using the Camera

Your smartphone features two digital cameras mounted on the front and on the rear. This section will take you through all the steps in taking photos and videos with your smartphone.

To activate the camera, tap **Camera** on the Home screen, or open the Applications menu and tap **Camera**.

Camera icons and indicators

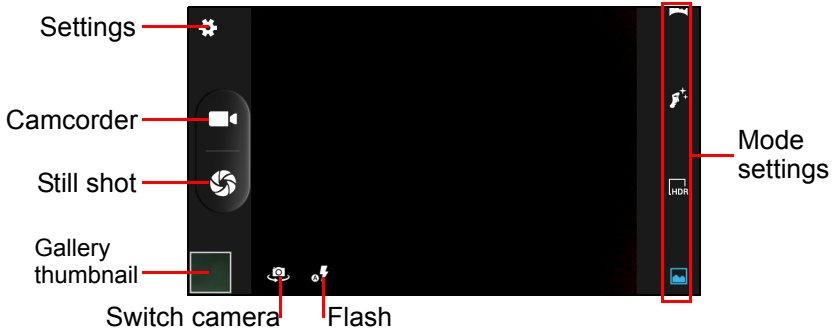

The camera window provides controls on either side of the image. Tap the area of the image you want to be the point of focus for the auto-focus lens (only available on the rear camera). Pinch the image to zoom in or out.

Tap  to take a picture. Tap the thumbnail in the bottom-left corner to open the gallery.

Tap the *Settings* icon in the upper-left corner to open the *Settings* menu.

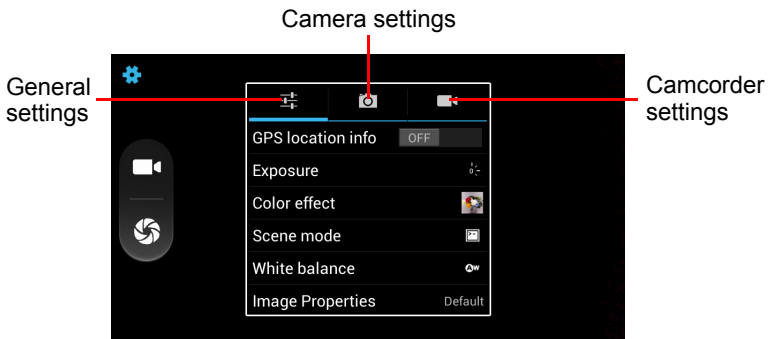

Settings menus

General

You may adjust the following:

- Turn **GPS info** on or off: Stores GPS information in the image information.
- **Exposure**: Over- or under-exposes the image.
- **Color effect**: Applies a color effect to the image.
 - None
 - Mono
 - Sepia
 - Negative
 - Aqua
 - Blackboard
 - Whiteboard
- **Scene mode**: Adjust photo parameters for a particular environment.
 - Auto
 - Night
 - Sunset
 - Party
 - Portrait
 - Landscape
 - Night portrait
 - Theatre
 - Beach
 - Snow
 - Steady photo
 - Fireworks
 - Sports
 - Candle light
- **White balance**: Compensate for different lighting environments.
 - Auto
 - Incandescent
 - Daylight
 - Fluorescent
 - Cloudy
 - Twilight
 - Shade
 - Warm fluorescent
- **Image properties**: Adjust the Sharpness, Hue, Saturation, Brightness, and Contrast.
- **Anti-flicker**: Turn the anti-flicker on or off, or select Auto.



.....
Note: Some of the settings above are not available on the front camera.
.....

Camera

You may adjust the following:

- Turn **Zero shutter delay** on or off: Takes the photo immediately when you tap the shutter button.
- Turn **Face detection** on or off: The camera automatically detects faces and focuses on them.
- Set the **Self timer**: Options are Off, 2 seconds or 10 seconds.

- **Continuous shot:** Set the maximum number of photos taken in a single burst.
- **Picture size:** Set the picture resolution.
- **Preview size:** Set the preview image ratio.
- **ISO:** Set the ISO value.

Camcorder

You may adjust the following:

- Turn **EIS** (Electronic Image Stabilization) on or off.
- Turn the **Microphone** on or off.
- Set the **Audio mode**.
- Set the **Time lapse interval**.
- Apply an **Effect** to the video.
- Set the **Video quality**.

Scene modes

Along the right-hand side of the screen are various mode settings, scroll up or down to view and select the desired mode setting. Tap an icon to select it. Settings available are:

- EV bracket shot
- Smile shot
- Multi-angle
- Face beauty
- Normal
- Best shot
- Auto scene detection
- Panorama
- HDR

Taking a photo

1. Ensure you have adjusted the settings described above.
2. Frame your subject and steady your smartphone.
3. Zoom in or out as needed.
4. Tap  to take a picture.

Taking a panoramic photo

Panoramic mode allows you to take a series of up to nine photos that the camera application will 'stitch' together to make a single extended image.

1. To take a panoramic photo, select panoramic capture mode.
2. Align the camera to take a photo of one end of the panoramic scene (the furthest left, right, top or bottom).
3. Press the camera button to take the first image; then smoothly turn the camera to the left or right to take the next image of the scene.
 - A blue dot shows the center of the next image; move the camera so the dot is in the center of the screen; your smartphone will then automatically capture an image and select the center of the next section of the image. Repeat to capture all images.



Note: If your photo needs fewer than nine images, tap the tick icon to stop the selection process and process the captured images.

The camera application will process the images and save a single extended image to your smartphone's gallery.



Note: Panoramic images work best with static outdoor scenes. Objects too close to the camera or large straight edges may confuse the detection process.

Shooting a video



Note: You do not need to select *Camcorder* to record video

1. Frame your subject and steady your smartphone and zoom in or out as needed.
2. Tap  to start taking a video. The icon will turn red to indicate that recording is in progress. Tap the icon again to stop recording.

Supported formats

Type	Formats
Image	JPEG, GIF, PNG, BMP
Video	MPEG-4, H.263, H.264

Viewing photos and videos

After you have taken your photo or video, it is automatically saved.

Once you have taken a photo or video, you can view it in Gallery by tapping the thumbnail in the lower-right corner. Alternatively, open the **Applications** menu and tap **Gallery**. From Gallery you can share the file directly using various services.



Note: Share options vary depending on the file type.

You may also edit photos you have taken by tapping the  icon in the lower left-hand corner.

Geotagging

Geotagging allows you to store the location where a photo or video was taken right in the photo or video itself.

For the geotag to display, pictures must be taken with **GPS Info** turned on.

Advanced settings

Putting your smartphone in Airplane mode

You can enter Airplane mode (also known as flight mode) to turn off telephone and Bluetooth functions and use your smartphone as a handheld device during a flight. Check with your airline to make sure this is permitted onboard.

Switch your smartphone off during takeoff and landing as it may interfere with aircraft electronic systems.

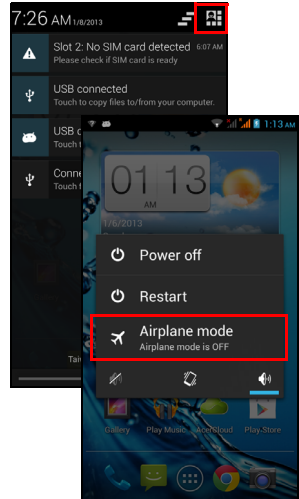

Turning Airplane mode on or off

1. Open the **Notification** area.
2. Tap  then tap **Airplane mode**.

-OR-

1. Press and hold the power button until you get the phone options menu.
2. Tap **Airplane mode** to switch it ON or OFF.



.....
Note: When Airplane mode is active, the  icon will be displayed in the Notification area.
.....

Restarting your phone

You can restart (reboot) your phone if you find apps are not responding.

1. Press and hold the power button until you get the phone options menu.
2. Tap **Restart**.

Adjusting settings

This section will show you how to adjust detailed settings for your phone, data, Wi-Fi and Bluetooth connections.

Activating or deactivating connections

Open the Application menu and tap **Settings** to manage your connection settings.

Item	Description
SIM management	Set a default SIM for particular functions (such as voice calling or messaging), turn the data connection on or off, set roaming preferences and associate contacts with a SIM.

Item	Description
Wi-Fi	Turn the Wi-Fi function on or off.
Bluetooth	Turn the Bluetooth function on or off.
Data usage	View an estimate of the mobile data used on each SIM.
Call settings	Adjust settings for Voice and Internet calls.
More...	<p>Access additional connection settings:</p> <p>Airplane mode: <i>Disable all wireless connections so you can safely use this device onboard an aircraft.</i></p> <p>VPN: <i>Set up and manage Virtual Private Networks.</i></p> <p>Tethering & portable hotspot: <i>Share your phone's mobile data connection via USB or as a portable Wi-Fi hotspot.</i></p> <p>Mobile networks: <i>Set your options for connecting to mobile networks.</i></p>



Important: If your phone is in Airplane mode, the option to turn Bluetooth on will be disabled. Please refer to "**Putting your smartphone in Airplane mode**" on **page 41** for instructions on turning Airplane mode on or off.

Adjusting Bluetooth settings

You can use Bluetooth to exchange information between your smartphone and other mobile devices.

Bluetooth connections

For all Bluetooth settings, open the Application menu and tap **Settings > Bluetooth**. Here you can switch Bluetooth on or off, set a device name and discoverability. Tap **SEARCH FOR DEVICES** to scan for available devices.

To connect to a device, tap the device in the list of available devices. You may be asked to enter a PIN on both devices to establish the connection.

To simply turn on or off Bluetooth, open the **Notification** area and tap the **Bluetooth** button.

Internet sharing

Tethering via USB

If you wish to share your mobile Internet connection with a computer, you can connect your phone to a PC using the supplied USB cable.

1. Plug the USB sync cable into the micro USB connector on your smartphone.
2. Plug the USB client connector into an available USB port on your computer.
3. Push the **Menu** button and then tap **Settings > More.. > Tethering & portable hotspot > USB tethering**.

Wi-Fi hotspot

You can turn your smartphone into a portable Wi-Fi hotspot to share your mobile Internet connection with up to 8 clients.

1. Push the **Menu** button and then tap **Settings > More... > Tethering & portable hotspot > Wi-Fi hotspot > Set up Wi-Fi hotspot**.
2. Set the Network SSID and adjust security between None and WPA2 PSK. Tap **Save** to finish.



.....
Note: When your smartphone is serving as a Wi-Fi hotspot, you can't use your phone's applications to access the Internet via its Wi-Fi connection.
.....

Phone network settings

In the Application menu tap **Settings > More... > Mobile networks** to adjust your network settings. You can turn data connection on or off when roaming, choose a preferred network mode, specify a network operator and define access point names.

Selecting a network

Your phone will automatically detect your carrier/network settings when you insert a new SIM card. However, you may prefer to manually select a network. This may be a good idea when roaming.



.....
Tip: When you are traveling, manually selecting a network may help to reduce your roaming charges. Check with your home service provider for the network offering the most competitive rates at your destination.
.....

1. Open the **Application** menu and tap **Settings > More... > Mobile networks > Network operators**.
2. Your phone will search for available networks.
3. Select your preferred network from the list generated. Your phone will attempt to register on the selected network.
4. Tap **Select automatically** to connect to the available network with the strongest signal. This may lead to your phone jumping between networks when you move around.



.....
Note: Contact your service provider should you have any problems obtaining voice mail and the text message service center numbers.
.....

Data usage control settings

Data usage controls let you monitor total usage by network type and application and then set limits if needed.

To access the Data usage settings, from the Application menu tap **Settings > Data usage**.



Note: To set a data limit, Wi-Fi or Mobile data must be enabled.

Phone settings

Many phone settings are automatically configured by your smartphone when you insert a SIM card. The device will communicate with your provider and automatically obtain all necessary settings, such as network name, voice mail and text message center numbers.

You can also view and modify these settings manually through the Call settings screen.

Open the dialer and tap the menu button, then tap **Settings**.

Sound

To adjust your phone's sound settings, in the Application menu tap **Settings > Sound**.

Item	Description
Vibrate	Vibrates the device for incoming calls.
Volumes	Adjust the Ringtone, Notifications, Alarm volumes.
Phone ringtone	Sets your default voice calls ringtone.
Default notification	Set your phone's default notification sound.
Dial pad touch tones	Play tones when using dial pad.
Touch sounds	Play sounds when touching certain UI elements.
Screen lock sound	Play sound when locking and unlocking the screen.
Vibrate on touch	Vibrate when pressing soft keys and on certain UI interactions.

Display

To adjust your phone's display settings, in the Application menu tap **Settings > Display**.

Item	Description
Brightness	Adjust screen brightness.
Wallpaper	Change the Home screen's wallpaper.
Theme	Change menu color.
Auto-rotate screen	Enable rotation of the screen when device is tilted.
Sleep	Adjust the delay before the screen automatically turns off.
Font size	Change the default font size for the UI.

Connecting to a PC

If you wish to transfer information between the microSD Card in your phone and your computer, you can connect your phone to a PC using the supplied USB cable. Plug the USB sync cable into the micro USB connector on your smartphone. Plug the USB client connector into an available USB port on your computer.

Open the **Notification** area, and tap **Connected as media device** to configure the USB options.

You will now be able to see the microSD Card in your phone as a drive in your computer's file explorer.

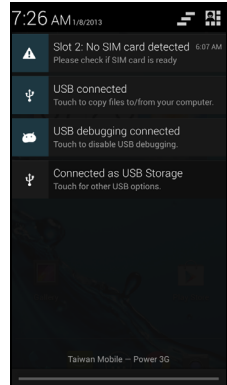

Note: After turning on USB storage, you will not be able to access the files in the microSD card or applications such as Gallery or Music.

Synchronization

You can sync your calendar, email and contacts on your phone and never worry about losing them again. Sync in real time or adjust it as you please. In the Application menu, tap **Settings**. Under ACCOUNTS, tap the appropriate account and again under ACCOUNTS tap that account's email address to access the synchronization settings.

To add a new account, tap **Add account**. Select the type of account (AcerCloud, Corporate, Email, Facebook, or Google) and then follow the on screen instructions.

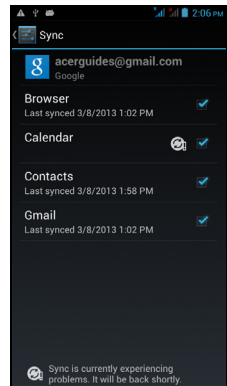

Google Sync

In Google, you can set synchronization for Browser, Calendar, Contacts, Gmail, and Google Photos. In your Google account's synchronization settings menu, tap the checkmark next to the item you would like to have auto-sync. Tap again to uncheck any for manual synchronization.

To manually synchronize an item, make sure the item is checked, tap the **Menu** button and then tap **Sync now**.



Note: You need a Google account to sync your calendar and appointments.

FM radio

The FM radio allows you to listen to your favorite stations while on the move. Headphones must be inserted to the 3.5 mm jack as it functions as an antenna.

You can access the radio by tapping **FM Radio** from the Application menu.

Tap the back icon to turn the radio off.

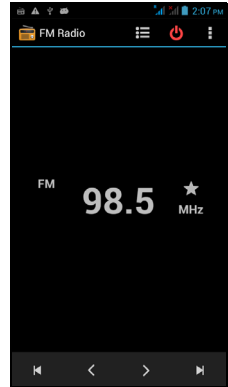

Multimedia playback

Your smartphone comes supplied with a variety of programs that you can use to enjoy multimedia content.

Adjusting the volume

Adjust the volume of your phone using the volume button on the side of the phone. Alternatively, you can set the Ringtone, Notifications, and Alarms volume by opening the **Application** menu and tapping **Settings > Sound > Volumes**.

Setting the date and time

To set the date and time, open the Application menu and tap **Settings > Date & time**.



.....
Tip: If you travel frequently or live in an area that uses daylight saving time, activate **Automatic date & time** from this menu. This will enable your smartphone to set the date and time based on information it receives from the network.
.....

Setting alarms

There are two predefined alarms on your phone by default. Tap **Clock** in the Application menu, and then tap **Set alarm** to edit alarm settings. You may:

- Turn the alarm on or off.
- Set the alarm time.
- Set which days to repeat the alarm.
- Set a ringtone.
- Enable or disable vibrate.
- Give it a label.

Changing language and text options

Set your location and language input preferences by opening the Application menu and going to **Settings > Language & input**.

Closing an application

To close an active application, in the Application menu tap **Settings > Apps**. Swipe over to the **Running** tab, then tap the program you wish to close. Select **Stop** to close the program.

Uninstalling an application

You can remove programs installed on your smartphone to free up extra storage memory.

1. In the Application menu tap **Settings > Apps**.
2. Swipe over to the **Downloaded** tab.
3. Find the application in the list and tap on it.
4. Tap the **Uninstall** button and then tap **OK**



.....
Warning! You should only remove programs if you are familiar with the Android operating system.
.....

Restoring to factory settings

You may perform a clean boot to restore your smartphone to the factory settings.



.....
Note: Before performing a clean boot, ensure that your smartphone is not locked. Press any key or tap the screen to see if the phone responds.
.....



.....
Warning! You should only perform a clean boot when all other options have failed to restore your smartphone to an operational state.
.....



.....
Warning! This will erase all your personal information, any contacts stored on your phone and any programs you installed.
.....

If your phone is responding to screen input, then open **Settings** from the Application menu. Tap **Backup & reset > Factory data reset > Reset phone** and then **Erase everything** to format your phone.

Accessories and tips

This chapter shows you how to use accessories with your smartphone, as well as provide useful tips for when you are using your smartphone.

Using the headset

Your smartphone is compatible with Acer headsets with built-in microphone for handsfree use when making calls.

To use the headset, plug it into the 3.5 mm headphone jack at the top of the phone.

When the headset is plugged in, all audio is routed to the headset, and the speakers are turned off.

- To answer an incoming call, press the button on the microphone.
- Adjust the volume using the volume up/down button on the smartphone.
- End the call by pressing the button again.

Using a Bluetooth headset

Your smartphone's Bluetooth functions make it fully compatible with all Bluetooth headsets. This allows you to use the unit handsfree when making calls, without the inconvenience of wires.

Creating a new access point

When you need to add another GPRS/3G/EDGE connection on your phone, obtain the access point name and settings (including username and password if required) from your wireless service provider.

1. Open the Application menu and tap **Settings** > **More...** > **Mobile networks** > **Access Point Names**, and select an operator.
2. Tap the **Menu** button and then tap **New APN**.
3. Enter the APN settings. Tap an item to adjust it.
4. When you have finished tap the **Menu** button and then tap **Save**.



.....
Important: Some providers and countries do not allow the use of a smartphone as a modem over HSDPA. Please check with your provider before attempting to do so.
.....

Inserting a microSD Card

Your smartphone features a memory expansion slot that accepts a microSD Card to expand memory and storage capacity.

Please refer to "**Installing a SIM or microSD Card**" on page 8 for instructions on installing a microSD Card.

Appendix

FAQ and troubleshooting

This section lists frequently asked questions that may arise during the use of your smartphone, and gives easy answers and solutions to these questions.

Aspect	Question	Answer
Audio	Why is there no sound coming from the device?	If the headset is plugged into the device, the speaker is automatically shut off. Disconnect the headset. Check that the device volume setting is not muted. Check that the volume control is not at its lowest setting.
Multimedia files	Why can't I view my video files?	You may be trying to view a video that is not supported. Refer to " Multimedia " on page 56 .
	Why can't I play my music files?	You may be trying to play a file that is not supported. Refer to " Multimedia " on page 56 .
System information and performance	How do I check the OS version of my device?	Tap Settings > About phone to check the OS version (Build number) and other hardware and software information.
Power	I can't turn on the device.	The battery power may be depleted. Recharge the device. Refer to " Charging the battery " on page 7 for more information.
RAM / ROM	How do I check the RAM and ROM memory status?	To check the ROM status, tap Settings > Storage . To check RAM status, tap Settings > Apps > RUNNING .
Internal storage	My device's available internal storage is full or almost full.	Uninstall applications to increase available storage. See " Uninstalling an application " on page 47 .

Aspect	Question	Answer
Unlock pattern	I forgot my unlock pattern.	<p>After a certain number of wrong entries, you will be presented with an option to reset your pattern. Tap Forgot pattern? and enter your google account username and password.</p> <p>Note: You must have an active Google account on the smartphone.</p> <p>Alternatively, you restore your smartphone to factory settings. See "Restoring to factory settings" on page 47.</p>
Heat	The phone heats up when charging or making long duration calls.	<p>It is normal for the phone to heat up when charging. When charging is complete, it will return to its normal temperature.</p> <p>It is also normal for the phone to heat up during long periods of use, such as watching a video or a long phone conversation.</p>

Other sources of help

For information on:	Refer to:
Up-to-date information regarding your smartphone	www.acer.com mobile.acer.com
Service enquiries	www.acer.com/support

Warnings and precautions

- Do not use this product near water.
- Do not place this product on an unstable cart, stand or table. If the product falls, it could be seriously damaged.
- Slots and openings are provided for ventilation to ensure reliable operation of the product and to protect it from overheating. These openings must not be blocked or covered. The openings should never be blocked by placing the product on a bed, sofa, rug or other similar surface. This product should never be placed near or over a radiator or heat register, or in a built-in installation unless proper ventilation is provided.
- Never push objects of any kind into this product through cabinet slots as they may touch dangerous voltage points or short-out parts that could result in a fire or electric shock. Never spill liquid of any kind onto or into the product.
- To avoid damage of internal components and to prevent battery leakage, do not place the product on a vibrating surface.
- Never use this product when engaging in sporting activities, exercising, or in any vibrating environment which may cause a short circuit or damage, and even a risk of explosion from the battery pack.

CAUTION when listening to music

To protect your hearing, follow these instructions.

- Increase the volume gradually until you can hear clearly and comfortably.
- Do not increase the volume level after your ears have adjusted.
- Do not listen to music at high volumes for extended periods.
- Do not increase the volume to block out noisy surroundings.
- Decrease the volume if you can't hear people speaking near you.

Additional safety information

Your device and its enhancements may contain small parts. Keep them out of the reach of small children.

Operating environment



.....
Warning! For safety reasons, turn off all wireless or radio transmitting devices when using your smartphone device under the following conditions. These devices may include, but are not limited to: wireless LAN (WLAN), Bluetooth and/or 3G.
.....

Remember to follow any special regulations in force in any area, and always switch off your device when its use is prohibited or when it may cause interference or danger. Use the device only in its normal operating positions. To successfully transmit data files or messages, this device requires a good quality connection to the network. In some cases, transmission of data files or messages may be delayed until such a connection is available. Ensure that the above separation distance instructions are followed until the transmission is completed. Parts of the device are magnetic. Metallic materials may be attracted to the device, and persons with hearing aids should not hold the device to the ear with the hearing aid. Do not place credit cards or other magnetic storage media near the device, because information stored on them may be erased.

Medical devices

Operation of any radio transmitting equipment, including wireless phones, may interfere with the functionality of inadequately protected medical devices. Consult a physician or the manufacturer of the medical device to determine if they are adequately shielded from external RF energy or if you have any questions. Switch off your device in health care facilities when any regulations posted in these areas instruct you to do so. Hospitals or health care facilities may be using equipment that could be sensitive to external RF transmissions.

Pacemakers. Pacemaker manufacturers recommend that a minimum separation of 15.3 cm (6") be maintained between wireless devices and a pacemaker to avoid potential interference with the pacemaker. These recommendations are consistent with the independent research by and recommendations of Wireless Technology Research. Persons with pacemakers should do the following:

- Always keep the device more than 15.3 cm (6") from the pacemaker.
- Not carry the device near your pacemaker when the device is switched on. If you suspect interference, switch off your device, and move it.

Hearing aids. Some digital wireless devices may interfere with some hearing aids. If interference occurs, consult your service provider.

Vehicles

RF signals may affect improperly installed or inadequately shielded electronic systems in motor vehicles such as electronic fuel injection systems, electronic anti-skid (anti-lock) braking systems, electronic speed control systems, and air bag systems. For more information, check with the manufacturer, or its representative, of your vehicle or any equipment that has been added. Only qualified personnel should service the device, or install the device in a vehicle. Faulty installation or service may be dangerous and may invalidate any warranty that may apply to the device. Check regularly that all wireless equipment in your vehicle is mounted and operating properly. Do not store or carry flammable liquids, gases, or explosive materials in the same compartment as the device, its parts, or enhancements. For vehicles equipped with an air bag, remember that air bags inflate with great force. Do not place objects, including installed or portable wireless equipment in the area over the air bag or in the air bag deployment area. If in-vehicle wireless equipment is improperly installed, and the air bag inflates, serious injury could result. Using your device while flying in aircraft is prohibited. Switch off your device before boarding an aircraft. The use of wireless teledevices in an aircraft may be dangerous to the operation of the aircraft, disrupt the wireless telephone network, and may be illegal.

Potentially explosive environments

Switch off your device when in any area with a potentially explosive atmosphere and obey all signs and instructions. Potentially explosive atmospheres include areas where you would normally be advised to turn off your vehicle engine. Sparks in such areas could cause an explosion or fire resulting in bodily injury or even death. Switch off the device at refueling points such as near gas pumps at service stations. Observe restrictions on the use of radio equipment in fuel depots, storage, and distribution areas; chemical plants; or where blasting operations are in progress. Areas with a potentially explosive atmospheres are often, but not always, clearly marked. They include below deck on boats, chemical transfer or storage facilities, vehicles using liquefied petroleum gas (such as propane or butane), and areas where the air contains chemicals or particles such as grain, dust or metal powders.

Follow any restrictions. Do not use the device where blasting is in progress.

Emergency calls

Important: Wireless phones, including this device, operate using radio signals, wireless networks, landline networks, and user-programmed functions. Because of this, connections in all conditions cannot be guaranteed. You should never rely solely on any wireless device for essential communications like medical emergencies.

If certain features are in use, you may first need to turn those features off before you can make an emergency call. Consult this guide or your service provider for more information.

When making an emergency call, give all the necessary information as accurately as possible. Your wireless device may be the only means of communication at the scene of an accident. Do not end the call until given permission to do so.

Taking care of your smartphone

1. **DO** take care not to scratch the screen of your smartphone. Keep the screen clean. When working with your smartphone, use your finger or fingernail. Never use an actual pen or pencil or other sharp object on the screen surface.
2. **DO NOT** expose your smartphone to rain or moisture. Do not let water enter the circuitry through the front panel buttons or expansion slots. In general, treat your smartphone as you would a mobile phone or other small electronic device.

3. **DO** be careful not to drop your smartphone or subject it to any strong impact. Do not place your smartphone in your back pocket.
4. **DO NOT** expose your smartphone to extreme temperatures. For example, do not leave your smartphone on the dashboard of a car on a hot day or when temperatures are below freezing point. Also, keep it away from heaters and other sources of heat.
5. **DO NOT** use or store your smartphone in any location that is dusty, damp or wet.
6. **DO** use a soft, damp cloth to clean your smartphone. If the surface of the screen becomes soiled, clean it with a soft cloth moistened with diluted window-cleaning solution.
7. **DO NOT** press down on the screen with force, otherwise you may crack the screen.

Managing your SIM cards

If your phone detects a new SIM card, you will be asked to confirm the preferred SIM to use for each action.

It indicates the following information:

1. The color used for each SIM card and its network name.
2. The preferred SIM for outgoing calls.
3. The preferred SIM for sending messages.
4. The preferred SIM for 3G data.

Tap **Change** to edit these settings from the *SIM Management* screen. You can also access the *SIM Management* functions by opening the **Application** menu and tapping **Settings** > **SIM management**.

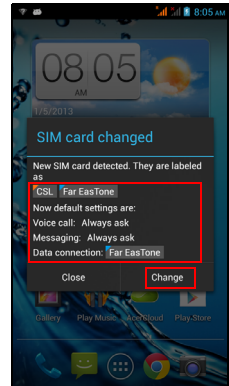

SIM Management

Open the **Application** menu and tap **Settings** > **SIM management**. From this screen, you can:

1. Enable or disable each SIM.
2. Configure each SIM's name, phone number, display numbers, and assign a color to each SIM (allowing you to quickly and easily recognize which SIM is active).
3. Set the default SIM for voice calls, messaging, and data connection.
4. General settings for each SIM.

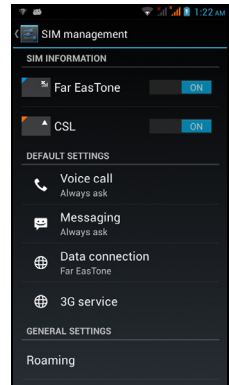

Selecting which SIM to use when making a call

If you have set *Voice call* to **Always ask**, you will be asked

which SIM to use each time you make call. Enter the number, then tap . A dialog opens; tap the SIM to use and the call will be connected.

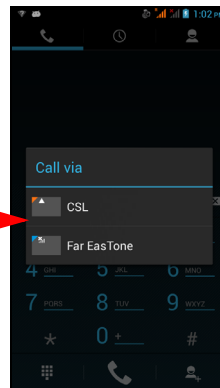
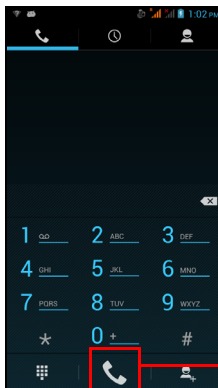

Selecting which SIM to use when sending a text message

If you have set *Messaging* to **Always ask**, you will be asked which SIM to use each time you send a text message. Enter the message and recipient information, then tap **Send**. A dialog opens; tap the SIM to use and the message will be sent.

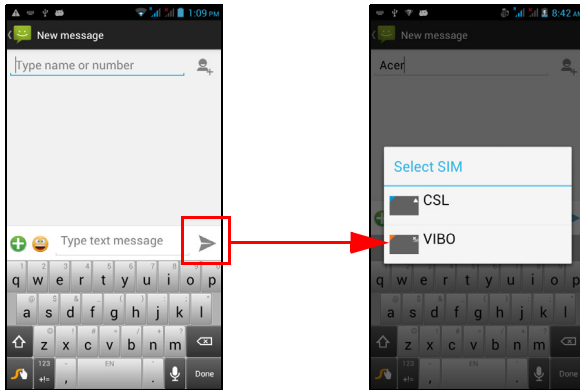

Identifying calls

Whenever you receive a call, the caller's number will be shown using the color defined for the SIM that the call is being received on. You will also be shown the name of the SIM receiving the call.

In the call log, the name of the SIM will be shown beneath the number of the call -- whether the call was missed, answered or was an outgoing call -- in the color you defined for that SIM.

Limitations when using two SIMs

When SIM1 is:	SIM2 cannot:
<ul style="list-style-type: none">• In a call• Ringing• Sending or receiving a message	<ul style="list-style-type: none">• Dial out• Receive a call (caller will get a "number not available" message)• Send or receive a message
<ul style="list-style-type: none">• Using a data connection	<ul style="list-style-type: none">• Use a data connection



Note: If you are using data on one SIM and you make or receive a call, or send or receive a text message on the other SIM, the first SIM's data connection will be temporarily halted.

Specifications

Performance

- MT6589 1.2 GHz quad-core processor
- System memory:
 - 1 GB of RAM
 - 4 GB of ROM
- Android operating system

Display

- 4.5" qHD LCD, capacitive touchscreen
- 960 x 540 resolution

Multimedia

Formats supported:

Type	Formats
Audio playback	MP3, AMR, WMA
Ringtone	MP3, MIDI, iMelody, WAVE, WMA
Video recording	3GP, MPEG-4, H.263, H.264
Video playback	3GP, MPEG-4, H.263, H.264, WMV

USB connector

- Micro USB connector
- USB client
- DC power-in (5 V, 1 A)

Connectivity

- Bluetooth 3.0 with EDR
- IEEE Wi-Fi 802.11b/g/n
- GSM 850 / 900 / 1800 / 1900 MHz
- UMTS 900 / 2100 MHz
- HSPA / HSDPA / GPRS / EDGE
- GPS
- aGPS

Camera

- 8 MP rear with LED flash
- 2 MP front camera



Note: Specification varies depending on region and configuration.

Expansion

- microSD memory card slot (up to 32 GB)

Battery

- Rechargeable high density 2000 mAh Lithium-ion polymer battery (replaceable)



.....
Note: Length of battery operation will depend on power consumption which is based on system resource use. For example, constantly using the backlight or using power-demanding applications will shorten battery life between charges.
.....

Dimensions

Height	131 mm
Width	68 mm
Thickness	9.9 mm
Weight	140 g (with battery)

Safety

Battery information

Do not use this product in a humid, wet and/or corrosive environment. Do not put, store or leave your product in or near a heat source, in a high temperature location, in strong direct sunlight, in a microwave oven or in a pressurized container, and do not expose it to temperatures over 60 °C (140 °F). Failure to follow these guidelines may cause the battery to leak acid, become hot, explode or ignite and cause injury and/or damage. Do not pierce, open or disassemble the battery. If the battery leaks and you come into contact with the leaked fluids, rinse thoroughly with water and seek medical attention immediately. For safety reasons, and to prolong the lifetime of the battery, charging will not occur at low (below 0 °C/32 °F) or high (over 45 °C/113 °F) temperatures.

The full performance of a new battery is achieved only after two or three complete charge and discharge cycles. The battery can be charged and discharged hundreds of times, but it will eventually wear out. When the talk and standby times are noticeably shorter than normal, buy a new battery. Use only manufacturer approved batteries, and recharge your battery only with manufacturer approved chargers designated for this device.

Unplug the charger from the electrical plug and the device when not in use. Do not leave a fully charged battery connected to the AC charger, since overcharging may shorten its lifetime. If left unused, a fully charged battery will lose its charge over time. If the battery is completely discharged, it may take a few minutes before the charging indicator appears on the display or before any calls can be made.

Use the battery only for its intended purpose. Never use any charger or battery that is damaged.

Do not short-circuit the battery. Accidental short-circuiting can occur when a metallic object such as a coin, clip, or pen causes direct connection of the positive (+) and negative (-) terminals of the battery. These look like metal strips on the battery. This might happen, for example, when you carry a spare battery in your pocket or purse. Short-circuiting the terminals may damage the battery or the connecting object.

Leaving the battery in hot or cold places, such as in a closed car in summer or winter conditions, will reduce the capacity and lifetime of the battery. Always try to keep the battery between 15 °C and 25 °C (59 °F and 77 °F). A device with a hot or cold battery may not work temporarily, even when the battery is fully charged. Battery performance is particularly limited in temperatures well below freezing.

Do not dispose of batteries in a fire as they may explode. Batteries may also explode if damaged. Dispose of batteries according to local regulations. Please recycle when possible. Do not dispose as household waste.

Replacing the battery

Replace the battery with the same type as that which came bundled with your product. Use of another battery may present a risk of fire or explosion.



Warning! Batteries may explode if not handled properly. Do not disassemble or dispose of them in fire. Keep them away from children. Follow local regulations when disposing of used batteries.

Disposal and recycling information



Do not throw this electronic device into the trash when discarding.



To minimize pollution and ensure utmost protection of the global environment, please recycle. For more information on the Waste from Electrical and Electronics Equipment (WEEE) regulations, visit www.acer-group.com/public/Sustainability

EEE yönetmeliğine uygundur.

It is compliant with EEE regulations.

Regulatory information

Compliant with Russian regulatory certification.



RoHS compliance

This product is in compliance with Directive 2011/65/EU of the European Parliament and of the Council of 8 June 2011, on the restriction of the use of certain hazardous substances (RoHS) in electrical and electronic equipment and its amendments.

Prevention of hearing loss



A pleine puissance, l'écoute prolongée du baladeur peut endommager l'oreille de l'utilisateur.

Note: For France, mobile headphones or earphones for this device have been tested to comply with the Sound Pressure requirement laid down in the applicable NF EN 50332-1:2000 and/or NF EN 50332-2:2003 standards as required by French Article L. 5232-1.



Caution: Permanent hearing loss may occur if earphones or headphones are used at high volume for prolonged periods of time.

Wireless operation channels for different domains

N. America	2.412-2.462 GHz	Ch01 through Ch11
Japan	2.412-2.484 GHz	Ch01 through Ch14
Europe ETSI	2.412-2.472 GHz	Ch01 through Ch13

List of National Codes

This equipment may be operated in the following countries:

Country	ISO 3166 2 letter code	Country	ISO 3166 2 letter code
Austria	AT	Malta	MT
Belgium	BE	Netherlands	NT
Cyprus	CY	Poland	PL
Czech Republic	CZ	Portugal	PT
Denmark	DK	Slovakia	SK
Estonia	EE	Slovenia	SL
Finland	FI	Spain	ES
France	FR	Sweden	SE
Germany	DE	United Kingdom	GB
Greece	GR	Iceland	IS
Hungary	HU	Liechtenstein	LI
Ireland	IE	Norway	NO
Italy	IT	Switzerland	CH
Latvia	LV	Bulgaria	BG
Lithuania	LT	Romania	RO
Luxembourg	LU	Turkey	TR

Certificate Information (SAR)

This device meets the EU requirements (1999/519/EC) on the limitation of exposure of the general public to electromagnetic fields by way of health protection.

The limits are part of extensive recommendations for the protection of the general public. These recommendations have been developed and checked by independent scientific organizations through regular and thorough evaluations of scientific studies. To guarantee the safety of all persons, regardless of age and health, the limits include a significant safety buffer.

Before radio devices can be put in circulation, their agreement with European laws or limits must be confirmed; only then may the CE symbol be applied.

The unit of measurement for the European Council's recommended limit for mobile telephones is the "Specific Absorption Rate" (SAR). This SAR limit is 2.0 W/kg, averaged over 10 g of body tissue. It meets the requirements of the International Commission on Non-Ionizing Radiation Protection (ICNIRP) and was included in the European Standard EN 50360 for mobile radio devices. The SAR regulation for mobile telephones is in line with European Standard EN 62209-1. The maximum SAR value is calculated at the highest output level in all frequency bands of the mobile telephone.

For body worn operation, this phone (EU model) has been tested and meets the ICNIRP exposure guidelines, and was included in the European Standard EN 62311 and EN 62209-2 for use with accessories that contain no metal and that position the handset a minimum of 1.5 cm from the body. Use of other accessories may not ensure compliance with ICNIRP exposure guidelines. If you do not use a body-worn

accessory and are not holding the phone at the ear, position the handset a minimum of 1.5 cm from your body when the phone is switched on.

During use, the actual SAR level is usually much lower than the maximum value, because the mobile telephone works in different output levels. It only transmits with as much output as is required to reach the network. In general the following applies: The closer you are to a base station, the lower the transmission output of your mobile telephone. The tested SAR of this device is as follows:

NCC	CE	
Head (W/kg)	Head (W/kg)	Body (W/kg)
0.227	0.227	0.466

NCC warning

警語

經型式認證合格之低功率射頻電機，非經許可，公司、商號或使用者均不得擅自變更頻率、加大功率或變更原設計之特性及功能。

低功率射頻電機之使用不得影響飛航安全及干擾合法通信；經發現有干擾現象時，應立即停用，並改善至無干擾時方得繼續使用。

前項合法通信，指依電信法規定作業之無線電通信。

低功率射頻電機須忍受合法通信或工業、科學及醫療用電波輻射性電機設備之干擾，減少電磁波影響，請妥善使用。



.....
Note: SAR 標準值 2.0 W/kg; 送測產品實測值為 : 0.227 W/kg
.....

Certification logos

To view the certification logos on your device: tap **Settings** > **About phone** > **Legal information** > **Certification logo**.

CE 0682



À pleine puissance, l'écoute prolongée du baladeur peut endommager l'oreille de l'utilisateur.



CCAF133G0360T6



減少電磁波影響，請妥適使用
SAR標準值2.0W/kg，送測產品實測值為0.227 W/kg

Battery warning



ATTENZIONE! Rischio di esplosione della batteria se sostituita in modo errato. Sostituire la batteria con un una di tipo uguale o equivalente consigliata dalla fabbrica. Non disperdere le batterie nell'ambiente.



VORSICHT! Explosionsgefahr bei unsachgemäßen Austausch der Batterie. Ersatz nur durch denselben oder einem vom Hersteller empfohlenem ähnlichen Typ. Entsorgung gebrauchter Batterien nach Angaben des Herstellers.



ADVARSEL! Lithiumbatteri - Eksplosionsfare ved fejlagtig håndtering. Udskiftning må kun ske med batteri af samme fabrikat og type. Levér det brugte batteri tilbage til leverandøren.



WARNING! Explosionsfara vid felaktigt batteribyte. Använd samma batterityp eller en ekvivalent typ som rekommenderas av apparattillverkaren. Kassera använt batteri enligt fabrikantens instruktion.



VAROITUS! Paristo voi räjähtää, jos se on virheellisesti asennettu. Vaihda paristo ainoastaan laitevalmistajan suosittellemaan tyyppiin. Hävitä käytetty paristo valmistagan ohjeiden mukaisesti.



ATTENTION! Il y a danger d'explosion s'il y a remplacement incorrect de la batterie. Remplacer uniquement avec une batterie du même type ou d' un type équivalent recommandé par le constructeur. Mettre au rebut les batteries usagées conformément aux instructions du fabricant.



ADVARSEL! Eksplosjonsfare ved feilaktig skifte av batteri. Benytt samme batteritype eller en tilsvarende type anbefalt av apparatfabrikanten. Brukte batterier kasseres i henhold til fabrikantens instruksjoner.

Declaration of Conformity

We, Acer Incorporated,
of 8F., No. 88, Sec. 1, Xintai 5th Rd., Xizhi Dist, New Taipei City, 22181, Taiwan

Declare under sole responsibility that the product:

Model: V370

Description: Smart Handheld

To which this declaration relates, is in conformity with the following standards and/or other normative documents:

- EN 301 511 V9.0.2
- EN 301 908-1 V5.2.1; EN 301 908-2 V5.2.1
- EN 300 328 V1.7.1
- EN 300 440-1 V1.6.1; EN 300 440-2 V1.4.1
- EN 301 489-1 V1.9.2; EN 301 489-3 V1.4.1; EN 301 489-7 V1.3.1
- EN 301 489-17 V2.2.1; EN 301 489-24 V1.5.1
- EN 55022:2010/AC:2011 Class B; EN 55024:2010
- EN 55013:2001/A1:2003/A2:2006; EN 55020:2007/A11:2011
- EN 60950-1:2006+A11:2009+A1:2010+A12:2011
- EN 50332-1:2000; EN 50332-2:2003
- EN 50360:2001/A1:2012; EN 62311:2008; EN 62209-1:2006; EN 62209-2:2010; EN 62479:2010
- EN 50581:2012

We hereby declare that the above named product is in conformance to all the essential requirements of the the RoHS Directive 2011/65/EU and R&TTE Directive (1999/5/EC) issued by the Commission of the European Community.

The conformity assessment procedure referred to in Article 10 and detailed in Annex [IV] of directive 1999/5/EC has been followed related to Articles:

- R&TTE Article 3.1 (a) Health and Safety
- R&TTE Article 3.1 (b) EMC
- R&TTE Article 3.2 Spectrum Usage

with the involvement of the following Notified Body:

CETECOM, Untertuerkheimer Str. 6 - 10 66117 Saarbruecken

Identification mark: **0682** (Notified Body) **CE**

The technical documentation relevant to the above equipment will be held at:

Acer Incorporated

8F., No. 88, Sec. 1, Xintai 5th Rd., Xizhi Dist, New Taipei City, 22181, Taiwan

Authorized person:

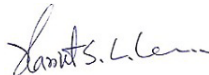

Name: Harriot SL Lee

For the addresses/telephone numbers of Acer service centers, please refer to the warranty card.

End User License Agreement

IMPORTANT-READ CAREFULLY: THIS END USER LICENSE AGREEMENT ("AGREEMENT") IS A LEGAL AGREEMENT BETWEEN YOU (EITHER AN INDIVIDUAL OR A SINGLE ENTITY), AND ACER INC. INCLUDING ITS SUBSIDIARIES ("ACER") FOR THE SOFTWARE (WHETHER PROVIDED BY ACER OR BY ACER'S LICENSORS OR SUPPLIERS) THAT ACCOMPANIES THIS AGREEMENT, INCLUDING ANY ASSOCIATED MEDIA, PRINTED MATERIALS AND RELATED USER ELECTRONIC DOCUMENTATION WHICH MAY BE BRANDED "ACER" ("SOFTWARE"). AGREEMENTS RELATING TO ANY OTHER PRODUCT OR TOPIC ARE NEITHER INTENDED NOR SHOULD THEY BE IMPLIED. BY INSTALLING THE ACCOMPANYING SOFTWARE OR ANY PORTION THEREOF, YOU AGREE TO BE BOUND BY THE TERMS AND CONDITIONS OF THIS AGREEMENT. IF YOU DO NOT AGREE TO ALL OF THE TERMS AND CONDITIONS OF THIS AGREEMENT, DO NOT CONTINUE THE INSTALLATION PROCESS AND IMMEDIATELY DELETE ALL INSTALLED FILES, IF ANY, OF THE ACCOMPANYING SOFTWARE FROM YOUR PHONE.

IF YOU DO NOT HAVE A VALIDLY-LICENSED COPY OF THE APPLICABLE SOFTWARE, YOU ARE NOT AUTHORIZED TO INSTALL, COPY OR OTHERWISE USE THE SOFTWARE, AND HAVE NO RIGHTS UNDER THIS AGREEMENT.

The Software is protected by U.S. and international copyright laws and conventions as well as other intellectual property laws and treaties. The Software is licensed, not sold.

GRANT OF LICENSE

Acer grants to you the following non-exclusive and non-transferable rights with respect to the Software. Under this Agreement, you may:

1. Install and use the Software only on a single designated phone. A separate license is required for each phone on which the Software will be used;
2. Make one copy of the Software solely for backup or archival purposes;
3. Make one hardcopy of any electronic documents included in the Software, provided that you receive the documents electronically.

RESTRICTIONS

You may NOT:

1. Use or copy the Software except as provided in this Agreement;
2. Rent or lease the Software to any third party;
3. Modify, adapt, or translate the Software in whole or in part;
4. Reverse engineer, decompile, or disassemble the Software or create derivative works based upon the Software;
5. Merge the Software with any other program or modify the Software, except for your personal use; and
6. Sublicense or otherwise make the Software available to third parties, except that you may, after prior written notification to Acer, transfer the Software as a whole to a third party so long as you do not retain any copies of the Software and such third party accepts the terms of this Agreement.
7. Transfer your rights under this Agreement to any third parties.
8. Export the Software in contravention of applicable export laws and regulations, or (i) sell, export, re-export, transfer, divert, disclose technical data, or dispose of, any Software to any prohibited person, entity, or destination including, without limitation, Cuba, Iran, North Korea, Sudan and Syria; or (ii) use any Software for any use prohibited by the laws or regulations of the United States.

SUPPORT SERVICES

Acer is not obligated to provide technical or other support for the Software.

ACER LIVE UPDATE

Certain of the software contains elements that enable the use of the Acer Live Update service, which allows for updates for such software to be automatically downloaded and installed on your phone. By installing the software, you hereby agree and consent that Acer (or its licensors) may automatically check the version of such software that you are using on your phone and may provide upgrades to such software that may be automatically downloaded on to your phone.

OWNERSHIP AND COPYRIGHT

Title, ownership rights and intellectual property rights in and to the Software and all copies thereof shall remain with Acer or Acer's licensors or suppliers (as applicable). You do not have or shall not gain any proprietary interest in the Software (including any modifications or copies made by or for you) or any related intellectual property rights. Title and related rights in the content accessed through the Software is the property of the applicable content owner and may be protected by applicable law. This license gives you no rights to such contents. You hereby agree

1. Not to remove any copyright or other proprietary notices from the Software;
2. To reproduce all such notices on any authorized copies you make; and
3. To use best efforts to prevent any unauthorized copying of the Software.

TRADEMARKS

This Agreement does not grant to you any rights in connection with any trademarks or service marks of Acer or of Acer's licensors or suppliers.

DISCLAIMER OF WARRANTIES

TO THE MAXIMUM EXTENT PERMITTED BY APPLICABLE LAW, ACER, ITS SUPPLIERS, AND ITS LICENSORS, PROVIDE THE SOFTWARE "AS IS" AND WITH ALL FAULTS, AND HEREBY DISCLAIM ALL OTHER WARRANTIES AND CONDITIONS, EITHER EXPRESS, IMPLIED OR STATUTORY, INCLUDING, BUT NOT LIMITED TO, ANY IMPLIED WARRANTIES, DUTIES OR CONDITIONS OF MERCHANTABILITY, OF FITNESS FOR A PARTICULAR PURPOSE, OF ACCURACY OR COMPLETENESS OF RESPONSES, OF RESULTS, OF WORKMANLIKE EFFORT, OF LACK OF VIRUSES, AND OF LACK OF NEGLIGENCE, ALL WITH REGARD TO THE SOFTWARE AND THE PROVISION OF OR FAILURE TO PROVIDE SUPPORT

SERVICES. ALSO, THERE IS NO WARRANTY OR CONDITION OF TITLE, QUIET ENJOYMENT, QUIET POSSESSION, CORRESPONDENCE TO DESCRIPTION OR NON-INFRINGEMENT WITH REGARD TO THE SOFTWARE.

EXCLUSION OF INCIDENTAL, CONSEQUENTIAL AND CERTAIN OTHER DAMAGES

TO THE MAXIMUM EXTENT PERMITTED BY APPLICABLE LAW, IN NO EVENT SHALL ACER, ACER'S SUPPLIERS, OR ACER'S LICENSORS, BE LIABLE FOR ANY SPECIAL, INCIDENTAL, INDIRECT, PUNITIVE, OR CONSEQUENTIAL DAMAGES WHATSOEVER (INCLUDING, BUT NOT LIMITED TO, DAMAGES FOR LOSS OF PROFITS OR CONFIDENTIAL OR OTHER INFORMATION, FOR BUSINESS INTERRUPTION, FOR PERSONAL INJURY, FOR LOSS OF PRIVACY, FOR FAILURE TO MEET ANY DUTY INCLUDING OF GOOD FAITH OR OF REASONABLE CARE, FOR NEGLIGENCE, AND FOR ANY OTHER PECUNIARY OR OTHER LOSS WHATSOEVER) ARISING OUT OF OR IN ANY WAY RELATED TO THE USE OF OR INABILITY TO USE THE SOFTWARE, THE PROVISION OF OR FAILURE TO PROVIDE SUPPORT SERVICES, OR OTHERWISE UNDER OR IN CONNECTION WITH ANY PROVISION OF THIS AGREEMENT, EVEN IN THE EVENT OF THE FAULT, TORT (INCLUDING NEGLIGENCE), STRICT LIABILITY, BREACH OF CONTRACT OR BREACH OF WARRANTY OF ACER OR ITS SUPPLIERS OR LICENSORS, AND EVEN IF ACER AND ITS SUPPLIERS AND LICENSORS HAVE BEEN ADVISED OF THE POSSIBILITY OF SUCH DAMAGES.

LIMITATION OF LIABILITY AND REMEDIES

NOTWITHSTANDING ANY DAMAGES THAT YOU MIGHT INCUR FOR ANY REASON WHATSOEVER (INCLUDING, WITHOUT LIMITATION, ALL DAMAGES REFERENCED ABOVE AND ALL DIRECT OR GENERAL DAMAGES), THE ENTIRE LIABILITY OF ACER, ITS SUPPLIERS, AND ITS LICENSORS, UNDER ANY PROVISION OF THIS AGREEMENT, AND YOUR EXCLUSIVE REMEDY FOR ALL OF THE FOREGOING, SHALL BE LIMITED TO THE AGGREGATE AMOUNT PAID BY YOU FOR THE SOFTWARE. THE FOREGOING LIMITATIONS, EXCLUSIONS AND DISCLAIMERS (INCLUDING DISCLAIMER OF WARRANTIES AND EXCLUSION OF INCIDENTAL, CONSEQUENTIAL AND CERTAIN OTHER DAMAGES ABOVE) SHALL APPLY TO THE MAXIMUM EXTENT PERMITTED BY APPLICABLE LAW, EVEN IF ANY REMEDY FAILS ITS ESSENTIAL PURPOSE; PROVIDED, HOWEVER, THAT BECAUSE SOME JURISDICTIONS DO NOT ALLOW THE EXCLUSION OR LIMITATION OR LIABILITY FOR CONSEQUENTIAL OR INCIDENTAL DAMAGES, THE ABOVE LIMITATION MAY NOT APPLY TO YOU.

TERMINATION

Without prejudice to any other rights, Acer may immediately terminate this Agreement without notice if you fail to comply with any terms and conditions of this Agreement.

In such event, you must:

1. Cease all use of the Software;
2. Destroy or return to Acer the original and all copies of the Software; and
3. Delete the Software from all phones on which it was resident.

All disclaimers of warranties and limitation of liability set forth in this Agreement shall survive termination of this Agreement.

GENERAL

This Agreement represents the complete agreement between you and Acer relating to this license for the Software and supersedes all prior agreements, communications, proposals and representations between the parties and prevails over any conflicting or additional terms of any quote, order, acknowledgement or similar communication. This Agreement may only be modified by a written document signed by both parties. If any provision of this Agreement is held by a court of competent jurisdiction to be contrary to law that provision will be enforced to the maximum extent permissible and the remaining provisions of this Agreement will remain in full force and effect.

ADDITIONAL PROVISIONS APPLICABLE TO THIRD PARTY SOFTWARE AND SERVICES

Software provided hereunder by Acer's licensors or suppliers ("Third Party Software") is made available to you for your personal, non-commercial use only. You may not use the Third Party Software in any manner that could damage, disable, overburden, or impair the services provided by Acer's licensors or suppliers hereunder ("Third Party Services"). Furthermore, you may not use the Third Party Software in any manner that could interfere with any other party's use and enjoyment of the Third Party Services, or the services and products of Acer's licensors' or suppliers' third party licensors. Your use of the Third Party Software and Third Party Services is also subject to additional terms and conditions and policies which can be accessed through our global website.

Privacy policy

During registration you will be asked to submit some information to Acer. Please refer to Acer's privacy policy at www.acer.com or your local Acer website.

Trademark information

DTS Sound™



For DTS patents, see <http://patents.dts.com>. Manufactured under license from DTS Licensing Limited. DTS, the Symbol, & DTS and the Symbol together are registered trademarks, and DTS Sound is a trademark of DTS, Inc. © DTS, Inc. All Rights Reserved.