



SAMSUNG

User Manual

ST6500

This user manual includes detailed usage instructions for your camera. Please read this manual thoroughly.

 [Click a topic](#)

Basic troubleshooting

Quick reference

Contents

Basic functions

Extended functions

Shooting options

Playback/Editing

Settings

Appendixes

Index

Health and safety information

Always comply with the following precautions and usage tips to avoid dangerous situations and ensure peak performance of your camera.



Warning—situations that could cause injury to yourself or others

Do not disassemble or attempt to repair your camera.

This may result in electric shock or damage to the camera.

Do not use your camera near flammable or explosive gases and liquids.

This may cause a fire or explosion.

Do not insert flammable materials into the camera or store these materials near the camera.

This may cause a fire or electric shock.

Do not handle your camera with wet hands.

This may result in electric shock.

Prevent damage to subjects' eyesight.

Do not use the flash in close proximity (closer than 1 m/3 ft) to people or animals. If you use the flash too close to your subject's eyes, this can cause temporary or permanent eyesight damage.

Keep your camera away from small children and pets.

Keep your camera and all accessories out of the reach of small children and animals. Small parts may cause choking or serious injury if swallowed. Moving parts and accessories may present physical dangers as well.

Do not expose the camera to direct sunlight or high temperatures for an extended period of time.

Prolonged exposure to sunlight or extreme temperatures can cause permanent damage to your camera's internal components.

Avoid covering the camera or charger with blankets or clothes.

The camera may overheat, which may distort the camera or cause a fire.

If liquid or foreign objects enter your camera, immediately disconnect all power sources, such as the battery or charger, and then contact a Samsung service center.



Caution—situations that could cause damage to your camera or other equipment

Remove the batteries from your camera when storing it for an extended period of time.

Installed batteries may leak or corrode over time and cause serious damage to your camera.

Use only authentic, manufacturer-recommended, Lithium-ion replacement batteries. Do not damage or heat the battery.

Inauthentic, damaged, or heated batteries may cause a fire or personal injury.

Use only Samsung-approved batteries, chargers, cables and accessories.

- Using unauthorized batteries, chargers, cables or accessories can cause the batteries to explode, damage your camera, or cause injury.
- Samsung is not responsible for damage or injuries caused by unapproved batteries, chargers, cables or accessories.

Use the battery only for its intended purpose.

Misusing the battery may cause a fire or electric shock.

Do not touch the flash while it fires.

The flash is very hot when fired and may burn your skin.

When you use AC charger, turn off the camera before you disconnect the power to the AC charger.

Failing to do so may result in fire or electric shock.

Disconnect the charger from the wall socket when not in use.

Failing to do so may result in fire or electric shock.

Do not use a damaged power supply cord, plug, or loose outlet when you charge batteries.

This may cause a fire or electric shock.

Do not allow the AC charger to come in contact with the +/- terminals on the battery.

This may cause a fire or electric shock.

Do not force the camera's parts or apply pressure to the camera.

This may cause your camera to malfunction.

Exercise caution when you connect cables or adapters and install batteries and memory cards.

If you force the connectors, improperly connect cables, or improperly install batteries and memory cards, you can damage ports, connectors, and accessories.

Keep cards with magnetic strips away from the camera case.

Information stored on the card may be damaged or erased.

Never use a damaged charger, battery, or memory card.

This may result in electric shock or camera malfunction or cause a fire.

Check that the camera is operating properly before use.

The manufacturer takes no responsibility for any loss of files or damage that may result from camera malfunction or improper use.

You must plug the end of the USB cable with the indicator light into your camera.

If the cable is reversed, it may damage your files. The manufacturer is not responsible for any loss of data.

Copyright information

- Microsoft Windows and the Windows logo are registered trademarks of the Microsoft Corporation.
- Mac is a registered trademark of the Apple Corporation.
- HDMI, the HDMI logo and the term "High Definition Multimedia Interface" are trademarks or registered trademarks of HDMI Licensing LLC.
- microSD™ and microSDHC™ are registered trademarks of the SD Association.
- Trademarks and trade names used in this manual are the property of their respective owners.

- Camera specifications or contents of this manual may be changed without prior notice due to upgrade of camera functions.
- You are not allowed to reuse or distribute any part of this manual without prior permission.
- For Open Source License information, refer to the 'OpenSourceInfo.pdf' in the provided CD-ROM.

Outline of the User Manual

Basic functions 12

Learn about your camera's layout, icons, and basic functions for shooting.

Extended functions 32

Learn how to capture a photo, record a video, and record a voice memo by selecting a mode.

Shooting options 50

Learn how to set the options in Shooting mode.

Playback/Editing 79

Learn how to play back photos, videos, or voice memos and edit photos or videos. Also, learn how to connect your camera to your computer, photo printer, TV, or HDTV.





Settings 107

Refer to options to configure your camera's settings.

Appendixes 114

Get information about error messages, specifications, and maintenance.

Icons used in this manual

Icon	Function
	Additional information
	Safety warnings and precautions
[]	Camera buttons. For example, [Shutter] represents the shutter button.
()	Page number of related information
→	The order of options or menus you must select to perform a step; for example: Touch  → Photo Size (represents Touch  , and then touch Photo Size).
*	Annotation

Abbreviations used in this manual

Abbreviation	Definition
ACB	Auto Contrast Balance
AEB	Auto Exposure Bracket
AF	Auto Focus
DIS	Digital Image Stabilization
DPOF	Digital Print Order Format
EV	Exposure Value
ISO	International Organization for Standardization
OIS	Optical Image Stabilization
WB	White Balance

Expressions used in this manual

Pressing the shutter

- Half-press [**Shutter**]: press the shutter halfway down
- Press [**Shutter**]: press the shutter all the way down

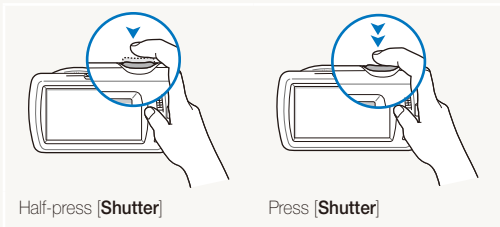

Exposure (Brightness)

The amount of light that enters your camera determines the exposure. You can alter the exposure with shutter speed, aperture value, and ISO sensitivity. By altering the exposure, your photos will be darker or lighter.



Normal exposure

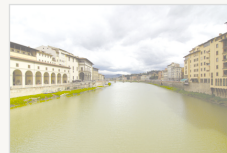

Overexposure (too bright)





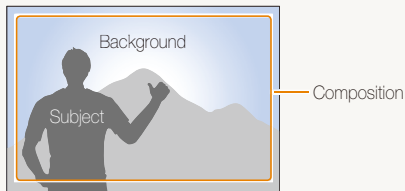



Subject, background, and composition

- **Subject**: the main object in a scene, such as a person, animal, or still life
- **Background**: the objects around the subject
- **Composition**: the combination of a subject and background



Basic troubleshooting

Learn to solve common problems by setting shooting options.

	The subject's eyes appear red.	<p>Red eye occurs when the subject's eyes reflect light from the camera flash.</p> <ul style="list-style-type: none">• Set the flash option to  Red-eye or  Red-eye Fix. (p. 55)• If the photo has already been captured, select Red-eye Fix in the edit menu. (p. 96)
	Photos have dust spots.	<p>If dust particles are present in the air, you may capture them in photos when you use the flash.</p> <ul style="list-style-type: none">• Turn off the flash or avoid capturing photos in a dusty place.• Set ISO sensitivity options. (p. 57)
	Photos are blurred.	<p>Blurring can occur if you capture photos in low light conditions or hold the camera incorrectly.</p> <ul style="list-style-type: none">• Use the OIS function or half-press [Shutter] to ensure the subject is focused. (p. 29)• Use the DUAL IS mode. (p. 35)
	Photos are blurred when shooting at night.	<p>As the camera tries to let in more light, the shutter speed slows. This can make it difficult to hold the camera steady long enough to take a clear picture and may result in camera shake.</p> <ul style="list-style-type: none">• Select Night Shot mode. (p. 37)• Turn on the flash. (p. 55)• Set ISO sensitivity options. (p. 57)• Use a tripod to prevent your camera from shaking.
	Subjects come out too dark because of backlighting.	<p>When the light source is behind the subject or when there is a high contrast between the light and dark areas, the subject may appear too dark.</p> <ul style="list-style-type: none">• Avoid shooting toward the sun.• Select Backlight in Scene mode. (p. 36)• Set the flash option to  Fill in. (p. 55)• Adjust the exposure. (p. 67)• Set the Auto Contrast Balance (ACB) option. (p. 68)• Set the metering option to  Spot if a bright subject is in the center of the frame. (p. 68)

Quick reference



Capturing photos of people

- Beauty Shot mode ▶ 37
- Red-eye/Red-eye Fix (to prevent or correct red-eye) ▶ 55
- Face Detection ▶ 62



Capturing photos at night or in the dark

- Scene mode > Sunset, Dawn ▶ 36
- Night Shot mode ▶ 37
- Flash options ▶ 55
- ISO sensitivity (to adjust the sensitivity to light) ▶ 57



Capturing action photos

- Continuous, Motion Capture ▶ 71



Adjusting the exposure (brightness)

- ISO sensitivity (to adjust the sensitivity to light) ▶ 57
- EV (to adjust exposure) ▶ 67
- ACB (to compensate for subjects against bright backgrounds) ▶ 68
- Metering ▶ 68
- AEB (to take 3 photos of the same scene with different exposures) ▶ 71



Capturing photos of text, insects, or flowers

- Scene mode > Text ▶ 36
- Close Up mode ▶ 36
- Macro ▶ 58



Applying effects to photos

- Object Highlight mode ▶ 42
- Magic Frame shot mode ▶ 43
- Photo Filter mode ▶ 43
- Vignetting mode ▶ 46
- Smart Filter effects ▶ 72
- Image Adjust (to adjust Sharpness, Contrast, or Saturation) ▶ 75



Applying effects to videos

- Movie Filter mode ▶ 45
- Vignetting mode ▶ 46
- Palette Effect mode ▶ 47



Reducing camera shake

- Optical Image Stabilization (OIS) ▶ 29
- DUAL IS mode ▶ 35

- Viewing files by category in Smart album ▶ 83
- Viewing files in 3D view ▶ 84
- Viewing files as thumbnails ▶ 85
- Deleting files on the memory card ▶ 86
- Viewing files as a slide show ▶ 88
- Viewing files on a TV or HDTV ▶ 97
- Connecting your camera to a computer ▶ 99
- Adjusting sound and volume ▶ 109
- Adjusting the brightness of the display ▶ 110
- Changing the display language ▶ 111
- Setting the date and time ▶ 111
- Before contacting a service center ▶ 124

Contents

Basic functions	12	Extended functions	32
Unpacking	13	Using shooting modes	33
Camera layout	14	Using the Smart Auto mode	33
Inserting the battery and memory card	16	Using the Simple Shot mode	34
Charging the battery and turning on your camera	17	Using the DUAL IS mode	35
Charging the battery	17	Using the Scene mode	36
Turning on your camera	17	Using the Close Up mode	36
Performing the initial setup	18	Using the Night Shot mode	37
Learning icons	20	Using the Beauty Shot mode	37
Using the touch screen	21	Using the Program mode	38
Setting the touch screen and sound	23	Using the Movie mode	39
Setting the display type for the touch screen	23	Using the Smart Movie mode	40
Setting the sound	23	Using effect modes	42
Using the Home screen	24	Using the Object Highlight mode	42
Accessing the Home screen	24	Using the Magic Frame Shot mode	43
Icons on the Home screen	24	Using the Photo Filter mode	43
Rearranging icons	25	Using the Movie Filter mode	45
Capturing photos	26	Using the Vignetting mode	46
Zooming	27	Using the Palette Effect mode	47
Reducing camera shake (OIS)	29	Recording voice memos	48
Tips for getting a clearer photo	30	Recording a voice memo	48
		Adding a voice memo to a photo	49

Shooting options	50	Using face detection	62
Selecting a resolution and quality	51	Detecting faces	62
Selecting a resolution	51	Capturing a self portrait shot	63
Selecting image quality	52	Capturing a smile shot	63
Using the timer	54	Detecting eye blinking	64
Shooting in the dark	55	Using Smart Face Recognition	64
Preventing red-eye	55	Registering faces as your favorites (My Star)	65
Using the flash	55	Adjusting brightness and color	67
Adjusting the ISO sensitivity	57	Adjusting the exposure manually (EV)	67
Changing the camera's focus	58	Compensating for backlighting (ACB)	68
Using macro	58	Changing the metering option	68
Using smart touch focus	59	Selecting a light source (White balance)	69
Using one touch shooting	60	Using burst modes	71
Adjusting the focus area	60	Applying effects/Adjusting images	72
		Applying Smart Filter effects	72
		Adjusting your photos	75
		Reducing the sound of the zoom	76
		Available shooting options by shooting mode	77

Playback/Editing	79	Settings	107
Viewing photos or videos in Playback mode	80	Settings menu	108
Starting Playback mode	80	Accessing the settings menu	108
Viewing photos	87	Sound	109
Playing a video	89	Display	109
Playing a voice memo	91	Connectivity	110
Editing a photo	92	General	111
Resizing photos	92	Appendixes	114
Rotating a photo	93	Error messages	115
Using Smart Crop	93	Camera maintenance	116
Applying Smart Filter effects	94	Cleaning your camera	116
Adjusting your photos	94	Using or storing the camera	117
Creating a print order (DPOF)	96	About memory cards	118
Viewing files on a TV or HDTV	97	About the battery	120
Transferring files to your Windows computer	99	Before contacting a service center	124
Transferring files with Intelli-studio	100	Camera specifications	127
Transferring files by connecting the camera		Glossary	131
as a removable disk	102	FCC notice	136
Disconnecting the camera (for Windows XP)	103	Index	137
Transferring files to your Mac computer	104		
Printing photos with a PictBridge photo printer	105		

Basic functions

Learn about your camera's layout, icons, and basic functions for shooting.

Unpacking	13	Setting the touch screen and sound	23
Camera layout	14	Setting the display type for the touch	
Inserting the battery and memory card ...	16	screen	23
Charging the battery and turning on your		Setting the sound	23
camera	17	Using the Home screen	24
Charging the battery	17	Accessing the Home screen	24
Turning on your camera	17	Icons on the Home screen	24
Performing the initial setup	18	Rearranging icons	25
Learning icons	20	Capturing photos	26
Using the touch screen	21	Zooming	27
		Reducing camera shake (OIS)	29
		Tips for getting a clearer photo	30

Unpacking

The following items are included in your product box.

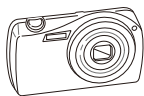

Camera



AC adapter/USB cable

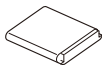

Rechargeable battery



Strap



Touch pen

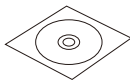

User Manual CD-ROM



Quick Start Manual

Optional accessories



Camera case

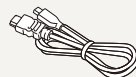

HDMI cable

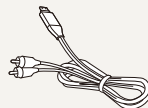

AV cable

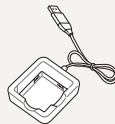

Battery charger



Memory card/
Memory card adapter



The illustrations may differ slightly from the items shipped with your product.

Camera layout

Before you start, familiarize yourself with your camera's parts and their functions.

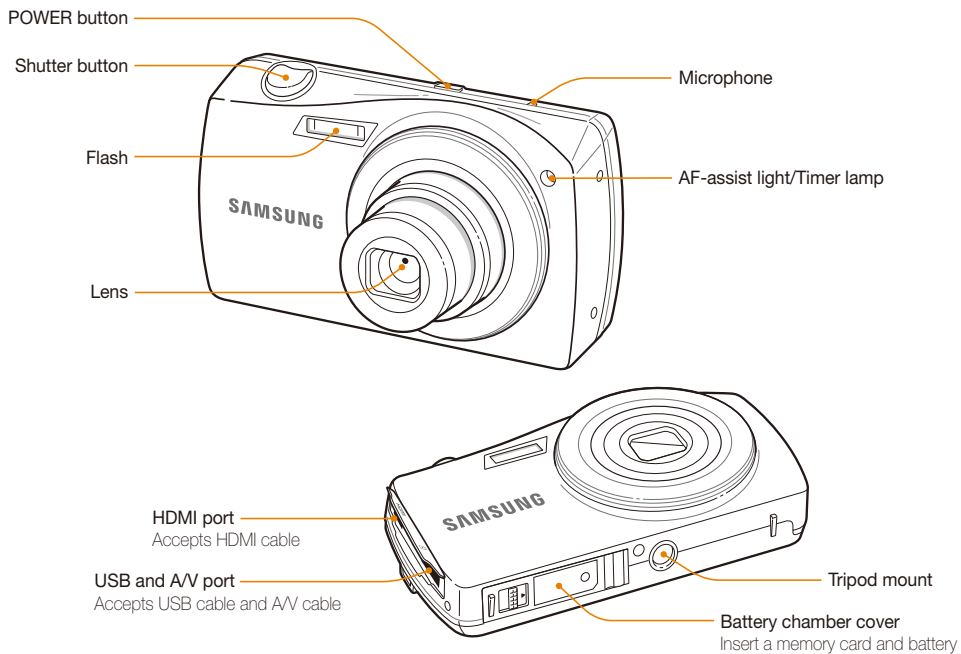

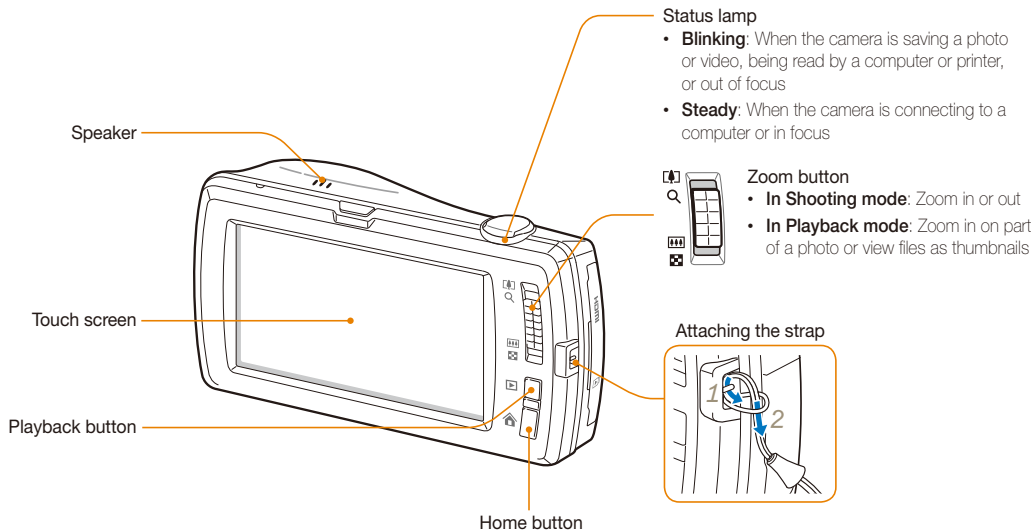

Inserting the battery and memory card

Learn how to insert the battery and an optional memory card into the camera.

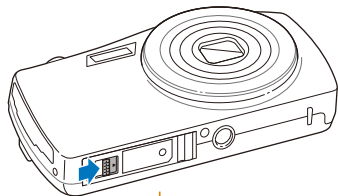

Insert a memory card with the gold-colored contacts facing up.

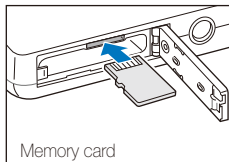

Insert the battery with the Samsung logo facing down.

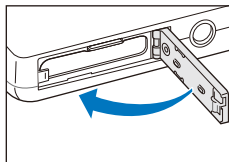
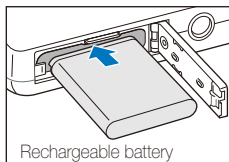

Removing the battery and memory card

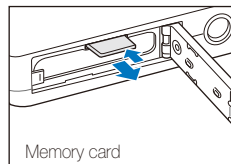

Push the card gently until it disengages from the camera, and then pull it out of the slot.

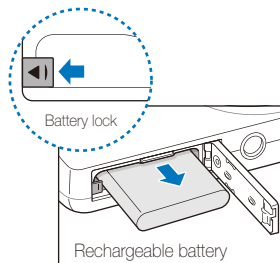

Slide the lock left to release the battery.



You can use the internal memory for temporary storage if a memory card is not inserted.

Charging the battery and turning on your camera

Charging the battery

Before you use the camera for the first time, you must charge the battery. Attach the USB cable to the AC adapter, and then plug the end of cable with the indicator light into your camera.

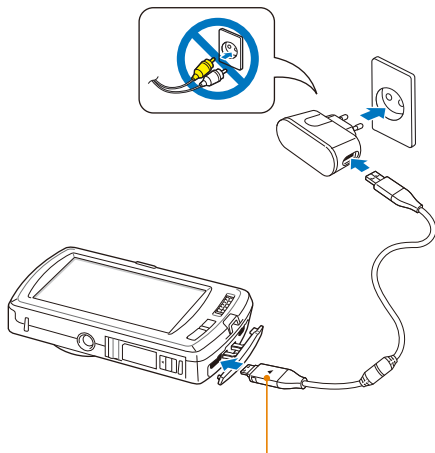

Indicator light

- **Red:** Charging
- **Green:** Fully charged

Turning on your camera

Press **[POWER]** to turn your camera on or off.

- The initial setup screen appears when you turn on the camera for the first time. (p. 18)

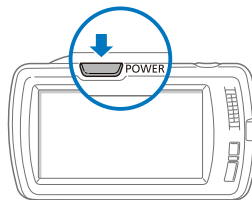

Turning on your camera in Playback mode

Press **[Playback]**. The camera turns on and immediately accesses Playback mode.

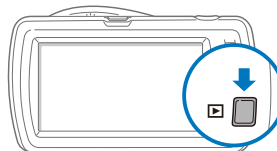

If you turn on your camera by pressing and holding **[Playback]** for about 5 seconds, the camera does not emit any sounds.

Performing the initial setup

When the initial setup screen appears, follow the steps below to configure the camera's basic settings.

1 Touch **Language**.

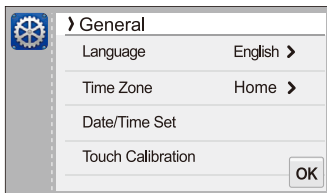

2 Select a language, and then touch **OK**.



3 Touch **Time Zone**.

4 Touch **Home**, and then touch **<** or **>** to select a time zone.

- When you travel to another country, touch **Visit**, and then select a new time zone.



5 Touch **OK** to save.

6 Touch **Date/Time Set**.

7 Touch the up or down arrows to set the date.

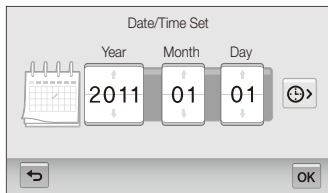

8 Touch , and then set the time.

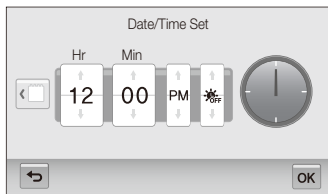



- To set daylight-saving time, touch .

9 Touch **OK** to save.

10 Touch **Touch Calibration**.

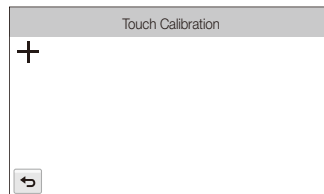
11 Touch the target on the screen with your touch pen.



 Touch directly in the center of the target for optimal performance.

12 Touch **OK** to save settings.

Learning icons

The icons the camera displays on the screen change according to the mode you select or the options you set.

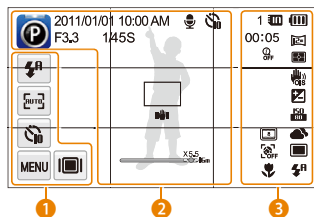

1 Option icons (touch)

Icon	Description
	Flash option
	Auto focus option
	Timer option
	Shooting options
	Display type

2 Status icons

Icon	Description
	Shooting mode
2011/01/01	Current date

Icon	Description
10:00 AM	Current time
F3.3	Aperture value
1/45S	Shutter speed
	Voice memo
	Timer
	Auto focus frame
	Camera shake
	Zoom indicator
X5.5	Zoom ratio
16m	Photo resolution when Intelli zoom is on
	Grid lines

3 Status icons

Icon	Description
1	Available number of photos
00:05	Available recording time
	Memory card not inserted (Internal memory)

Icon	Description
	Memory card inserted
	<ul style="list-style-type: none"> : Fully charged : Partially charged : Empty (Recharge)
	Photo resolution
	Video resolution
	Metering
	Optical Image Stabilization (OIS)
	Exposure value adjusted
	ISO sensitivity
	White balance
	Burst type
	Flash
	Intelli zoom is off
	Smart Filter
	Image Adjust
	Face detection
	Auto focus

Using the touch screen

Learn how to use the touch screen. Use the supplied touch pen to touch or drag on the screen.



Do not use sharp objects, such as pens or pencils, to touch the screen. You can damage the screen.

Touching

Touch an icon to select a menu or option.

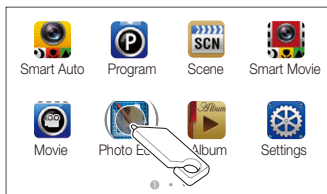

Flicking

Gently flick the touch pen across the screen.

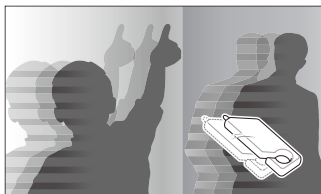

Dragging

Touch and hold a part of the screen, and then drag the touch pen.

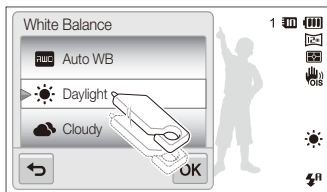

Selecting an option

- Drag the option list up or down until you find the desired option. Touch the option, and then touch **OK**.

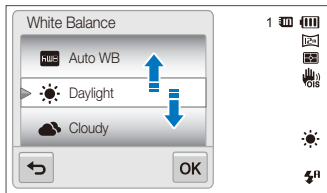

- If an option has a setting button, touch the button to turn it on or off.

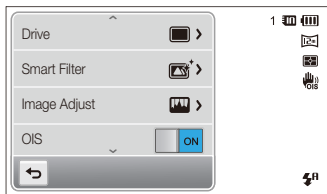

- The touch screen may not recognize your inputs if you touch multiple items at the same time.
- The touch screen may not recognize your inputs if you touch the screen with your finger.
- When you touch or drag the screen, discolorations may occur. This is not a malfunction, but a characteristic of the touch screen. Touch or drag lightly to minimize the effect.
- The touch screen may not work properly if you use the camera in extremely humid environments.
- The touch screen may not work properly if you apply screen protection film or other accessories to the screen.
- Depending on the viewing angle, the screen may appear dim. Adjust the brightness or viewing angle to improve the resolution.

Setting the touch screen and sound



Learn how to change the basic screen display and the sound settings.

Setting the display type for the touch screen

You can select from three screen display types. Each displays differently.

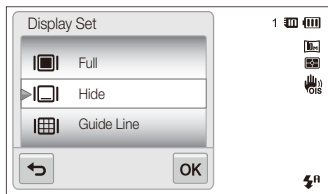
- 1 In Shooting mode, touch .
- 2 Select an option, and then touch **OK**.



Icon	Description
	Full: Icons are always displayed.
	Hide: Icons are hidden if you perform no operation for 5 seconds (touch the screen to display the icons again).
	Guide Line: Grid lines are displayed. The grid lines are helpful for getting the photo aligned with a surface, such as the horizon or the edges of buildings.

Setting the sound

Set your camera to emit or not to emit a sound when you perform functions.

- 1 On the Home screen, touch .
- 2 Touch **Sound**.
- 3 Touch the setting button next to **Beep Sound** to turn on or off the beep.

Using the Home screen

You can select a shooting mode or access the settings menu by touching the icons on the Home screen.

Accessing the Home screen

In Shooting or Playback mode, press [HOME]. Press [HOME] again to return to the previous mode.



No.	Description
1	Touch an icon to access a mode or function. <ul style="list-style-type: none">• Scroll to another page by dragging or flicking the touch pen on the screen.
2	The number of the current page. (1 2 3)

Icons on the Home screen

Icon	Description
	Smart Auto: Capture a photo using a scene mode selected automatically by the camera. (p. 33)
	Program: Capture a photo using manually setting options. (p. 38)
	Scene: Capture a photo using options that are preset for a specific scene. (p. 36)
	Smart Movie: Record a video using a scene mode selected automatically by the camera. (p. 40)
	Movie: Record a video. (p. 39)
	Photo Editor: Edit photos with various effects. (p. 94)
	Album: View files by category in Smart album. (p. 83)
	Settings: Adjust settings to match your preferences. (p. 108)
	Vignetting: Capture a photo or record a video with a vignetting effect. (p. 46)
	Beauty Shot: Capture a portrait with options to hide facial imperfections. (p. 37)
	Magic Frame shot: Capture a photo with various frame effects. (p. 43)

Icon	Description
	Photo Filter: Capture a photo with various filter effects. (p. 43)
	Movie Filter: Record a video with various filter effects. (p. 45)
	Night Shot: Capture a night scene using a shutter speed and aperture value set automatically by the camera. (p. 37)
	Palette Effect: Record a video with palette effects. (p. 47)
	Close Up: Capture close-up photos of subjects. (p. 36)
	Simple Shot: Capture a photo with simple adjustments to brightness and color. (p. 34)
	Object Highlight: Capture a photo with the subject's background blurred. (p. 42)
	3D Album: View files with 3D effects. (p. 84)
	Slide Show: View photos as a slide show with effects and music. (p. 88)
	Voice Recorder: Record and save a voice memo. (p. 48)
	Magazine: View files with page flip effect. (p. 84)
	DUAL IS: Reduce camera shake both optically and digitally to prevent blurred photos. (p.35)

Rearranging icons

You can rearrange the icons on the Home screen in any order.

1 Touch and hold an icon.

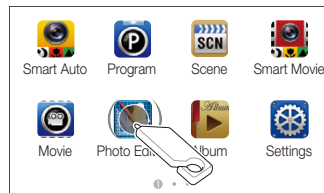

2 Drag it to a new location.

- To move an icon to another page, drag it to the left or right edge of the screen. When you drop the icon to a new location, the other icons will neatly slide out of the way.



Capturing photos

Learn how to capture photos easily and quickly in Smart Auto mode.

- 1 On the Home screen, touch .

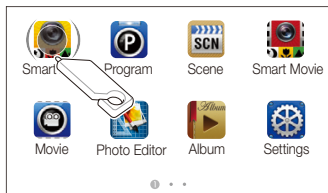

- 2 Align your subject in the frame.

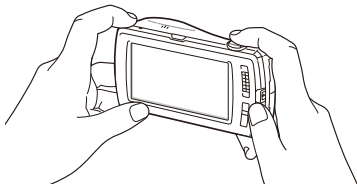

- 3 Half-press **[Shutter]** to focus.

- A green frame means the subject is in focus.
- A red frame means the subject is out of focus.

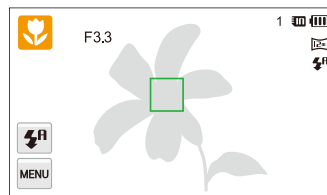

- 4 Press **[Shutter]** to capture a photo.

 See page 30 for tips to get clearer photos.

Zooming

You can capture close-up photos by adjusting the zoom. Your camera has a 5X Optical zoom, 2X Intelli zoom, and 5X Digital zoom. The Intelli zoom and Digital zoom cannot be used at the same time.



Zoom ratio

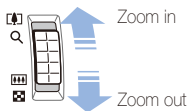

The available zoom ratio for videos differs from photo zoom ratio.

Digital zoom

If the zoom indicator is in the digital range, your camera is using the Digital zoom. By using both the Optical zoom and Digital zoom, you can zoom in up to 25 times.

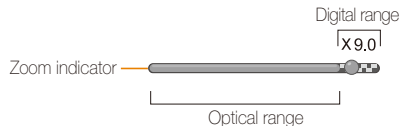

- The Digital zoom is available only in Program and Scene (except **Text**) modes.
- The Digital zoom is not available with a Smart Filter effect or Smart Touch AF option.
- If you capture a photo with the Digital zoom, the photo quality may deteriorate.

Intelli zoom

If the zoom indicator is in the Intelli range, your camera is using the Intelli zoom. Photo resolution varies by how much you have zoomed in if you use the Intelli zoom. By using both the Optical zoom and Intelli zoom, you can zoom in up to 10 times.

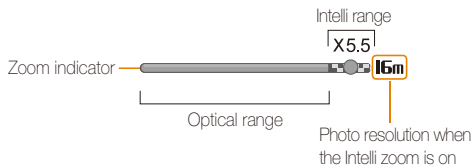

Setting Intelli zoom

- 1 In Shooting mode, touch **MENU**.
- 2 Touch the setting button next to **Intelli Zoom**.



- The Intelli zoom is available only in the Smart Auto, Program, and Scene (except **Text**) modes.
- The Intelli zoom is not available when you use a Smart Filter effect or the Smart Touch AF option.
- The Intelli zoom automatically turns on when you select the 4:3 aspect ratio. You can use the Digital zoom instead of the Intelli zoom by turning off the Intelli zoom. Intelli zoom is not available when you select the 16:9 aspect ratio.
- The Intelli zoom helps you capture a photo with less quality deterioration than the Digital zoom. However, the photo quality may be lower than when you use the Optical zoom.

Reducing camera shake (OIS)

Reduce camera shake optically in Shooting mode.

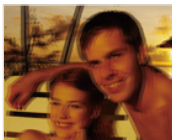

Before correction

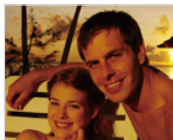

After correction

1 In Shooting mode, touch .

2 Touch the setting button next to OIS.

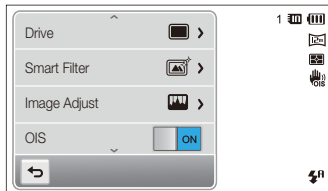

- OIS may not function properly when:
 - you move your camera to follow a moving subject
 - you use the Digital zoom
 - there is too much camera shake
 - the shutter speed is slow (for example, when you capture night scenes)
 - the battery is low
 - you capture a close-up shot
- If you use the OIS function with a tripod, the vibration of the OIS sensor may blur your images. Deactivate the OIS function when you use a tripod.
- If the camera is hit or dropped, the display will be blurry. If this occurs, turn off the camera, and then turn it on again.

Tips for getting a clearer photo

☺ Holding your camera correctly

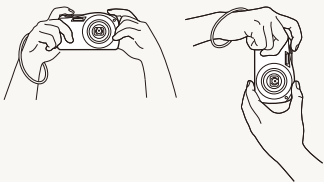

Ensure nothing is blocking the lens.

☺ Half-pressing the shutter button

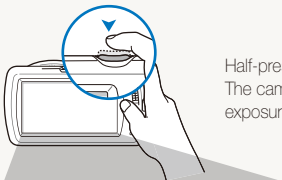

Half-press [**Shutter**] to adjust the focus. The camera adjusts the focus and exposure automatically.

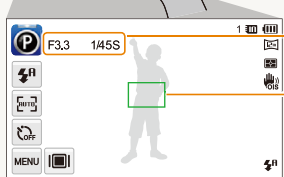

The camera sets the aperture value and shutter speed automatically.

Focus frame

- Press [**Shutter**] to capture the photo if the focus frame appears in green.
- Change the composition and half-press [**Shutter**] again if the focus frame appears in red.

☺ Reducing camera shake



- Set the Optical Image Stabilization option to reduce camera shake optically. (p. 29)
- Select the DUAL IS mode to reduce camera shake both optically and digitally. (p.35)

☺ When is displayed

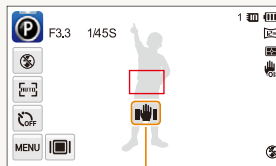

Camera shake

When you shoot in the dark, avoid setting the flash option to **Slow Sync** or **Off**. The aperture remains open longer and it may be harder to hold the camera steady long enough to take a clear picture.

- Use a tripod or set the flash option to **Fill in**. (p. 55)
- Set ISO sensitivity options. (p. 57)



Preventing your subject from being out of focus

It may be difficult to get your subject in focus when:

- there is little contrast between the subject and background (for example, when your subject is wearing clothing that is similar in color to the background)
- the light source behind the subject is too bright
- the subject is shiny or reflective
- the subject includes horizontal patterns, such as blinds
- the subject is not positioned in the center of the frame



Use the focus lock

Half-press **[Shutter]** to focus. When the subject is in focus, you can reposition the frame to change the composition. When you are ready, press **[Shutter]** to capture your photo.

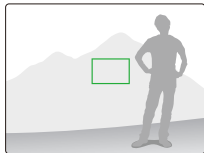
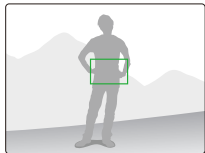

- When you capture photos in low light



Turn on the flash.
(p. 55)

- When subjects are moving rapidly

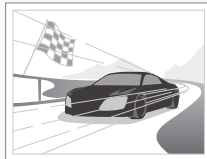

Use the Continuous
or Motion Capture
function. (p. 71)

Extended functions

Learn how to capture a photo, record a video, and record a voice memo by selecting a mode.

Using shooting modes	33	Using effect modes	42
Using the Smart Auto mode	33	Using the Object Highlight mode	42
Using the Simple Shot mode	34	Using the Magic Frame Shot mode	43
Using the DUAL IS mode	35	Using the Photo Filter mode	43
Using the Scene mode	36	Using the Movie Filter mode	45
Using the Close Up mode	36	Using the Vignetting mode	46
Using the Night Shot mode	37	Using the Palette Effect mode	47
Using the Beauty Shot mode	37	Recording voice memos	48
Using the Program mode	38	Recording a voice memo	48
Using the Movie mode	39	Adding a voice memo to a photo	49
Using the Smart Movie mode	40		

Using shooting modes

Capture photos or record videos by selecting the best shooting mode for the conditions.

Using the Smart Auto mode

In Smart Auto mode, your camera automatically chooses the appropriate camera settings based on the type of scene it detects. The Smart Auto mode is helpful if you are not familiar with the camera settings for various scenes.

- 1 On the Home screen, touch .
- 2 Align your subject in the frame.
 - The camera automatically selects a scene and adjusts its settings. An appropriate scene icon appears at the top left of the screen. The icons are listed below.



Icon	Description
	Landscapes
	Scenes with bright white backgrounds
	Landscapes at night (when the flash is off)

Icon	Description
	Portraits at night
	Landscapes with backlighting
	Portraits with backlighting
	Portraits
	Close-up photos of objects
	Close-up photos of text
	Sunsets
	Clear skies
	Forested areas
	Close-up photos of colorful subjects
	Camera is stabilized or on a tripod (when shooting in the dark)
	Actively moving subjects
	Fireworks (when using a tripod)

3 Half-press [Shutter] to focus.

- In several scenes, the camera automatically captures a photo when you half-press [Shutter].

4 Press [Shutter] to capture the photo.



- If the camera does not recognize an appropriate scene mode, it uses the default settings for the Smart Auto mode.
- Even if it detects a face, the camera may not select a portrait mode depending on the subject's position or lighting.
- The camera may not select the correct scene depending on the shooting conditions, such as camera shake, lighting, or distance to the subject.
- Even if you use a tripod, the camera may not detect the  mode if the subject is moving.
- In Smart Auto mode, the camera consumes more battery power, because it changes settings often to select appropriate scenes.

Using the Simple Shot mode

In Simple Shot mode, you can capture photos with simple adjustments to brightness and color.

1 On the Home screen, touch .

2 Drag the sliders to adjust **Brightness** and **Color**.

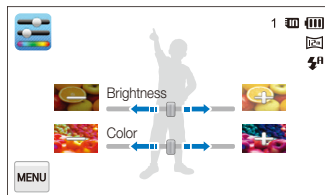

3 Align your subject in the frame, and then half-press [Shutter] to focus.

4 Press [Shutter] to capture the photo.

Using the DUAL IS mode

Reduce camera shake and prevent blurred photos with Optical and Digital Image Stabilization functions.

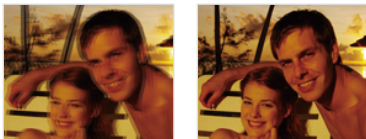

Before correction

After correction

1 On the Home screen, touch .

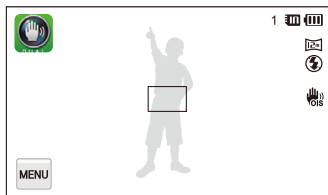

2 Align your subject in the frame, and then half-press **[Shutter]** to focus.

3 Press **[Shutter]** to capture the photo.









- The Digital zoom and Intelli-zoom are not available in DUAL IS mode.
- The camera will optically correct photos only when the light source is brighter than fluorescent light.
- If your subject is moving rapidly, the photo may be blurry.
- Set the Optical Image Stabilization option to reduce camera shake in different shooting modes. (p. 29)

Using the Scene mode

In Scene mode, you can capture a photo with options that are preset for a specific scene.

- 1 On the Home screen, touch  **SCM**.
- 2 Touch a scene.

Option	Description
	Landscape: Capture still-life scenes and landscapes.
	Sunset: Capture scenes at sunset, with natural-looking reds and yellows.
	Dawn: Capture scenes at sunrise.
	Backlight: Capture backlit subjects.
	Beach & Snow: Reduce underexposed photos due to sunlight reflected from sand or snow.
	Text: Clearly capture text from printed or electronic documents.

- 3 Align your subject in the frame, and then half-press **[Shutter]** to focus.
- 4 Press **[Shutter]** to capture the photo.

Using the Close Up mode

In Close Up mode, you can capture close-up photos of subjects, such as flowers or insects.

- 1 On the Home screen, touch .

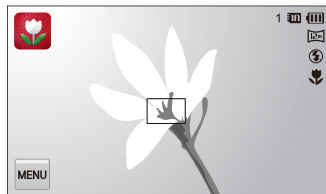

- 2 Align your subject in the frame, and then half-press **[Shutter]** to focus.
- 3 Press **[Shutter]** to capture the photo.

Using the Night Shot mode

In Night mode, you can use a slow shutter speed to extend the time the shutter stays open. Increase the aperture value to prevent overexposure.

- 1 On the Home screen, touch .
- 2 Drag the dials on the screen in the arrow directions below to adjust shutter speed and aperture value.

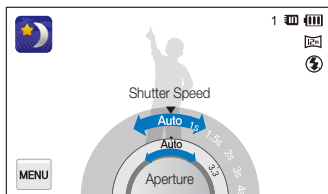

- 3 Align your subject in the frame, and then half-press [**Shutter**] to focus.
- 4 Press [**Shutter**] to capture the photo.

 Use a tripod to prevent blurry photos.

Using the Beauty Shot mode

In Beauty Shot mode, you can capture a portrait with options to hide facial imperfections.

- 1 On the Home screen, touch .
- 2 Drag the sliders to adjust **Face Tone** and **Face Retouch**.
 - For example, increase the **Face Tone** setting to make skin appear lighter.

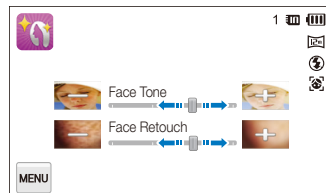

- 3 Align your subject in the frame, and then half-press [**Shutter**] to focus.
- 4 Press [**Shutter**] to capture the photo.

 When using the Beauty Shot mode, the focus distance will be set to Auto Macro.

Using the Program mode

In Program mode, you can set most options, except the shutter speed and aperture value, which the camera sets automatically.

- 1 On the Home screen, touch **P**.
- 2 Touch **MENU**, and then set desired options.
(For a list of options, refer to page 50.)

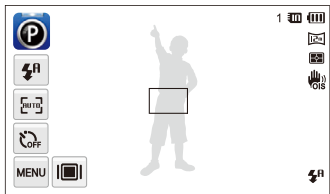

- 3 Align your subject in the frame, and then half-press **[Shutter]** to focus.
- 4 Press **[Shutter]** to capture the photo.

Setting My screen

In Program mode, you can add shortcuts for your favorite options to the left side of the screen.

- 1 In Shooting mode, touch **MENU** → **My screen** → **OK**.
- 2 Touch and hold one of the icons on the right.

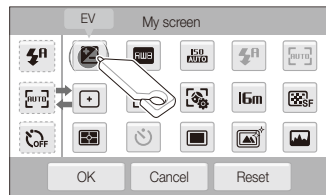

- 3 Drag the icon into a desired box on the left.
- To remove shortcuts, drag an icon to the right.

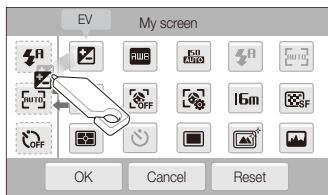

- 4 Touch **OK** to save.

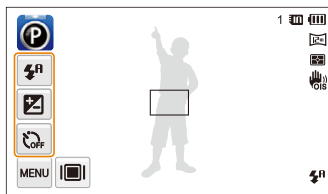

You can create up to 3 shortcuts.

Using the Movie mode

In Movie mode, you can record high-definition videos of up to 20 minutes in length. The camera saves recorded videos as MP4 (H.264) files.





- H.264 (MPEG-4 part10/AVC) is a high-compression video format established by the international standard organizations ISO-IEC and ITU-T.
- Some memory cards may not support high definition recording. If this occurs, set a lower resolution.
- Memory cards with slow writing speeds will not support high-resolution videos and high-speed videos. To record high-resolution or high-speed videos, use memory cards with faster writing speeds.
- If you have activated Optical Image Stabilization, the camera may record the sounds the OIS makes when it operates.

- On the Home screen, touch
- Touch **MENU**, and then set desired options.
(For a list of options, refer to page 50.)
- Press **[Shutter]** or touch to start recording.
- Press **[Shutter]** again or touch to stop recording.

Pause recording

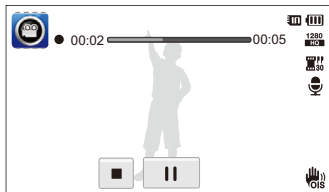
The camera allows you to temporarily pause a video while recording. With this function, you can record separate scenes as a single video.



- Touch  to pause while recording.
- Touch  to resume.

Using the Smart Movie mode

In Smart Movie mode, your camera automatically chooses the appropriate camera settings based on the scene it has detected.

- 1 On the Home screen, touch .
- 2 Align your subject in the frame.
 - The camera automatically selects a scene and adjusts its settings. An appropriate scene icon appears at the top left of the screen. The icon are listed below.

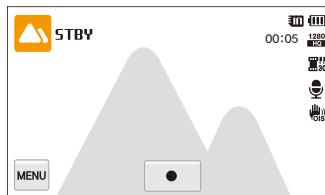

Icon	Description
	Landscapes
	Sunsets
	Clear skies
	Forested areas

3 Press [**Shutter**] or touch ● to start recording.

4 Press [**Shutter**] again or touch ■ to stop recording.



- If the camera does not recognize an appropriate scene mode, it uses the default settings for Smart Movie mode.
- The camera may not select the correct scene depending on the shooting conditions, such as camera shake, lighting, and distance to the subject.
- In Smart Scene Detection mode, you cannot set Smart Filter effects.

Using effect modes

Capture photos or record videos with various effects.



Using the Object Highlight mode

The Object Highlight mode makes the subject more discernible by adjusting the depth of field.

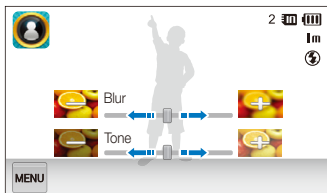
- 1 On the Home screen, touch .
- 2 Position the camera according to the optimum distance displayed on the screen.
 - The optimum distance will vary, based on the zoom ratio you use.
- 3 Drag the sliders to adjust **Blur** and **Tone**.



- 4 Half-press [**Shutter**] to focus.

- When the camera can apply the Object Highlight effect,  will appear.
- When the camera cannot apply the Object Highlight effect,  will appear. If this occurs, adjust the distance from the camera to the subject.

- 5 Press [**Shutter**] to capture the photo.



- Available resolutions in Object Highlight mode are **3m** and **1m**.
- If the shooting distance is not within the optimum range, you can capture a photo but the Object Highlight effect will not be applied.
- The Object Highlight effect cannot be used in dark places.
- The Object Highlight effect cannot be used with the Optical zoom at 3X or higher.
- Digital zoom is not available in Object Highlight mode.
- Use a tripod to prevent camera shake as the camera captures 2 consecutive photos to apply the effect.
- The subject and the background should have a significant contrast in color.
- Subjects should be positioned far away from the background for the greatest effect.

Using the Magic Frame Shot mode

In Magic Frame Shot mode, you can apply various frame effects to your photos. The shape and the feel of the photos will change according to the frame you select.

- 1 On the Home screen, touch .
- 2 Select a desired frame.



- 3 Align your subject in the frame, and then half-press [**Shutter**] to focus.
- 4 Press [**Shutter**] to capture the photo.

 In Magic Frame Shot mode, the resolution is automatically set to .

Using the Photo Filter mode

In Photo Filter mode, you can apply various filter effects to your photos.



Miniature



Vignetting



Fish-eye



Sketch

- 1 On the Home screen, touch .
- 2 Touch a desired filter.
 - To view the original photo, touch **Before**.
 - To view the photo with the filter effect, touch **After**.

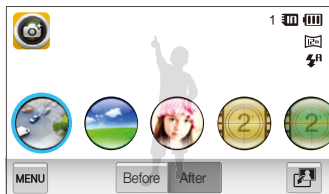

Option	Description
Miniature	Apply a tilt-shift effect to make the subject appear in miniature.
Vignetting	Apply the retro-looking colors, high contrast, and strong vignette effect of Lomo cameras.
Soft-Focus	Hide facial imperfections or apply dreamy effects.
Old Film 1	Apply vintage film effect 1.
Old Film 2	Apply vintage film effect 2.
Half Tone Dot	Apply a halftone effect.
Sketch	Apply a pen sketch effect.

Option	Description
Fish-eye	Blacken the edges of the frame and distort objects to imitate the visual effect of a fisheye lens.
Defog	Make a photo clearer.
Classic	Apply a black and white effect.
Retro	Apply a sepia tone effect.
Negative	Apply a negative film effect.

- Align your subject in the frame, and then half-press **[Shutter]** to focus.
- Press **[Shutter]** to capture the photo.



- To apply filter effects to saved photos, touch .
- When you select **Sketch**, the resolution will change to **5m** and below.

Using the Movie Filter mode

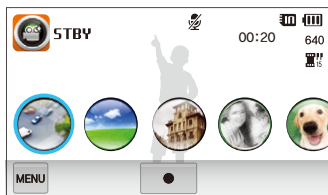

In Movie Filter mode, you can record videos with various filter effects.

- 1 On the Home screen, touch .
- 2 Touch a desired filter.



Option	Description
Miniature	Apply a tilt-shift effect to make the subject appear in miniature.
Vignetting	Apply the retro-looking colors, high contrast, and strong vignette effect of Lomo cameras.
Half Tone Dot	Apply a halftone effect.
Sketch	Apply a pen sketch effect.

Option	Description
Fish-eye	Distort close objects to imitate the visual effect of a fisheye lens.
Defog	Make the image clearer.
Classic	Apply a black and white effect.
Retro	Apply a sepia tone effect.
Negative	Apply a negative film effect.



- 3 Press [**Shutter**] or touch  to start recording.
- 4 Press [**Shutter**] again or touch  to stop recording.



- If you select **Miniature**, the speed of the video will increase.
- If you select **Miniature**, the camera will not record sound.
- If you select **Miniature**, **Vignetting**, **Half Tone Dot**, **Sketch**, **Fish-eye**, or **Defog**, the recording speed will be set to  and the recording resolution will be set to less than 640.



Using the Vignetting mode

In Vignetting mode, you can capture a photo or record a video with a vignetting effect.

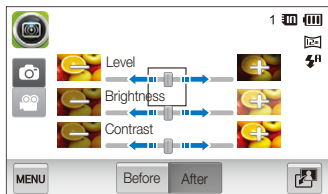
- 1 On the Home screen, touch .
- 2 Select  (photo) or .
- 3 Drag the sliders to adjust **Level**, **Brightness**, and **Contrast**.
 - To view the original photo, touch **Before**.
 - To view the photo with the vignetting effect, touch **After**.



- 4 Align your subject in the frame, and then half-press **[Shutter]** to focus.
- 5 Press **[Shutter]** to capture the photo.

 To apply the vignetting effect to saved photos, touch .



Using the Palette Effect mode

In Palette Effect mode, you can record a video with effects to make specific colors stand out.

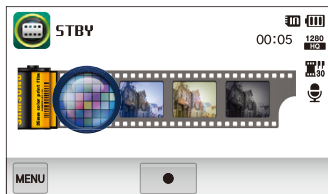
- 1 On the Home screen, touch .
- 2 Touch a desired palette.



Option	Description
Palette Effect 1	Create a vivid look with sharp contrast and red color.
Palette Effect 2	Make scenes clean and clear by applying a soft blue tone.
Palette Effect 3	Apply a soft brown tone.
Palette Effect 4	Create a cold and monotone effect.

- 3 Press **[Shutter]** or touch  to start recording.
- 4 Press **[Shutter]** again or touch  to stop recording.





Recording voice memos

Learn how to record a voice memo that you can play back later. You can also add a voice memo to a photo to remind you of shooting conditions.



You will get the best sound quality when you speak 16 in (40 cm) away from the camera.

Recording a voice memo

- 1 On the Home screen, touch .
- 2 Press **[Shutter]** or touch  to start recording.
 - Touch  to pause or touch  to resume.
 - Each memo can be up to 10 hours long if memory is available.

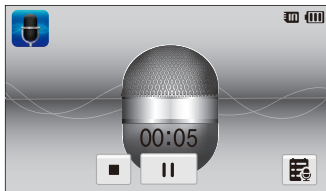

- 3 Press **[Shutter]** again or touch  to stop recording.



To view the list of saved voice memos, touch .

Adding a voice memo to a photo

In Program mode, you can add a voice memo to a captured photo.

- 1 On the Home screen, touch .
- 2 Touch **MENU**, and then touch the setting button next to **Memo**.
- 3 Align your subject in the frame, and then capture a photo.
 - The camera begins to record a voice memo right after you capture the photo.

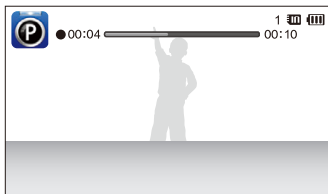

- 4 Record a short voice memo (10 seconds maximum).
 - Press [**Shutter**] to stop recording a voice memo before the 10 seconds are up.



You cannot add voice memos to photos in the burst mode.

Shooting options

Learn how to set the options in Shooting mode.

Selecting a resolution and quality	51	Detecting eye blinking	64
Selecting a resolution	51	Using Smart Face Recognition	64
Selecting image quality	52	Registering faces as your favorites (My Star)	65
Using the timer	54	Adjusting brightness and color	67
Shooting in the dark	55	Adjusting the exposure manually (EV)	67
Preventing red-eye	55	Compensating for backlighting (ACB)	68
Using the flash	55	Changing the metering option	68
Adjusting the ISO sensitivity	57	Selecting a light source (White balance) ...	69
Changing the camera's focus	58	Using burst modes	71
Using macro	58	Applying effects/Adjusting images	72
Using smart touch focus	59	Applying Smart Filter effects	72
Using one touch shooting	60	Adjusting your photos	75
Adjusting the focus area	60	Reducing the sound of the zoom	76
Using face detection	62	Available shooting options by shooting mode	77
Detecting faces	62		
Capturing a self portrait shot	63		
Capturing a smile shot	63		

Selecting a resolution and quality

Learn how to change the image resolution and quality settings.



Selecting a resolution

As you increase the resolution, your photo or video will include more pixels so it can be printed on larger paper or displayed on a larger screen. When you use a high resolution, the file size will also increase.

Setting the photo resolution

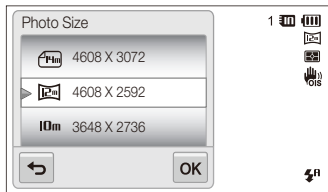
- 1 In Shooting mode, touch **MENU** → **Photo Size**.
- 2 Select an option, and then touch **OK**.



Icon	Description
16m	4608 X 3456 : Print on A1 paper.
	4608 X 3072 : Print on A1 paper in wide ratio (3:2).
	4608 X 2592 : Print on A1 paper in panorama ratio (16:9) or play back on an HDTV.
10m	3648 X 2736 : Print on A2 paper.
5m	2592 X 1944 : Print on A4 paper.
3m	1984 X 1488 : Print on A5 paper.
	1920 X 1080 : Print on A5 paper in panorama ratio (16:9) or play back on an HDTV.
1m	1024 X 768 : Attach to an email.

Setting the video resolution

- 1 In Shooting mode, touch **MENU** → **Movie Size**.
- 2 Select an option, and then touch **OK**.

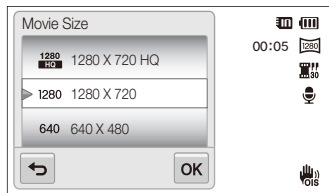

Icon	Description
	1280 X 720 HQ: Play back high-quality files on an HDTV.
	1280 X 720: Play back on an HDTV.
	640 X 480: Play back on an analog TV.
	320 X 240: Post on a web page.

Selecting image quality

Set the photo and video quality settings. Higher image quality settings will result in larger file sizes.

Setting the photo quality

The camera compresses and saves the photos you capture in the JPEG format.

- 1 In Shooting mode, touch **MENU** → **Quality**.
- 2 Select an option, and then touch **OK**.

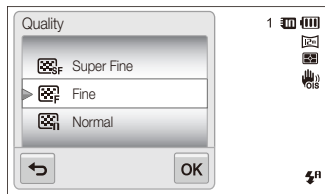



Icon	Description
	Super Fine: Capture photos in super high quality.
	Fine: Capture photos in high quality.
	Normal: Capture photos in normal quality.

Setting the video quality

The camera compresses and saves the videos you record in the MP4 (H.264) format.

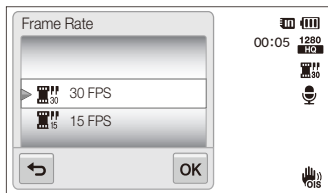
- 1 In Shooting mode, touch **MENU** → **Frame Rate**.
- 2 Select an option, and then touch **OK**.
 - As the frame rate increases, action appears more natural, but the file size also increases.



Icon	Description
	30 FPS: Record 30 frames per second.
	15 FPS: Record 15 frames per second.

Using the timer

Learn how to set the timer to delay shooting.

- 1 In Shooting mode, touch **MENU** → **Timer**.
- 2 Select an option, and then touch **OK**.

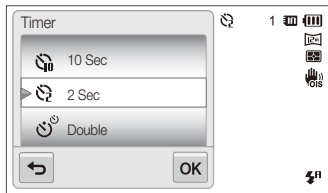

Icon	Description
	Off: The timer is not active.
	10 Sec: Capture a photo after a 10-second delay.
	2 Sec: Capture a photo after a 2-second delay.
	Double: Capture one photo after a 10-second delay and another photo after a 2-second delay.

Available options may differ depending on the shooting mode.

- 3 Press **[Shutter]** to start the timer.

- The AF-assist light/timer lamp blinks. The camera will automatically capture a photo at the specified time.



- Press **[Shutter]** to cancel the timer.
- Depending on the Face Detection option you have selected, the timer function or some of its options may not be available.
- Self timer options are not available if you set burst options.

Shooting in the dark

Learn how to capture photos at night or in low light conditions.

Preventing red-eye

If the flash fires when you capture a photo of a person in the dark, a red glow may appear in the person's eyes. To prevent this, select **Red-eye** or **Red-eye Fix**. Refer to flash options in "Using the flash."





This option is available in Program, Beauty Shot, and Night Shot modes.



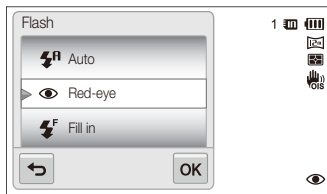

Using the flash

Use the flash when you capture photos in the dark or when you need more light in your photos.

- 1 In Shooting mode, touch **MENU** → **Flash**.
- 2 Select an option, and then touch **OK**.



Icon	Description
	Off: <ul style="list-style-type: none">• The flash will not fire.• The camera will display the shake warning  when you are shooting in low light.
	Auto: The flash will fire automatically when the subject or background is dark.

Icon	Description
	<p>Red-eye:</p> <ul style="list-style-type: none"> The flash will fire twice when the subject or background is dark to reduce the red-eye effect. There is an interval between 2 bursts of the flash. Do not move until the flash fires a second time.
	<p>Fill in:</p> <ul style="list-style-type: none"> The flash always fires. The camera automatically adjusts the flash's intensity.
	<p>Slow Sync:</p> <ul style="list-style-type: none"> The flash fires and the shutter stays open longer. This option is recommended when you want to capture ambient light to reveal more details in the background. Use a tripod to prevent your photos from blurring. The camera will display the shake warning  when you are shooting in low light.
	<p>Red-eye Fix:</p> <ul style="list-style-type: none"> The flash fires twice when the subject or background is dark, and the camera corrects red-eyes through its advanced software analysis. There is an interval between 2 bursts of the flash. Do not move until the flash fires a second time.

Available options may differ depending on the shooting mode.



- Flash options are not available if you set burst options or select **Self-Portrait** or **Blink Detection**.
- Make sure that your subjects are within the recommended distance from the flash. (p. 128)
- If light from the flash is reflected or there is a substantial amount of dust in the air, tiny spots may appear in your photo.

Adjusting the ISO sensitivity

The ISO sensitivity is the measure of a film's sensitivity to light as defined by the International Organization for Standardization (ISO). The higher ISO sensitivity you select, the more sensitive to light your camera becomes. With a higher ISO sensitivity, you can get a better photo without using the flash.

- 1 In Shooting mode, touch **MENU** → **ISO**.
- 2 Select an option, and then touch **OK**.
 - Select **Auto** to have the camera select an appropriate ISO sensitivity automatically based on the brightness of the subject and lighting.

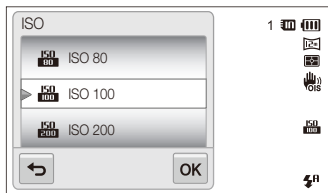

Higher ISO sensitivities may result in more image noise.

Changing the camera's focus

Learn how to adjust the camera's focus to suit the subject and the shooting conditions.

Using macro

Use macro to capture close-up photos of subjects, such as flowers or insects.



- Try to hold the camera firmly to prevent blurry photos.
- Turn off the flash if the distance to the subject is less than 16 in (40 cm).

- 1 In Shooting mode, touch **MENU** → **Focus**.
- 2 Select **Macro**, and then touch **OK**.

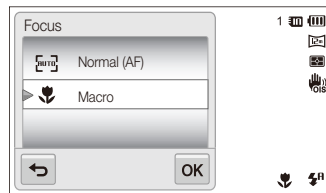

Icon	Description
	Normal (AF): Focus on a subject farther than 32 in (80 cm) from the camera.
	Macro: Manually focus on a subject that is 2-32 in (5-80 cm) from the camera (39-59 in [100-150 cm] when you use the zoom).

Using smart touch focus

Smart Touch AF allows you to track and auto focus on your subject, even when you are moving.

- 1 In Shooting mode, touch **MENU** → **Focus Area**.
- 2 Select **Smart Touch AF**, and then touch **OK**.
- 3 Touch the subject you want to track in the touch area.

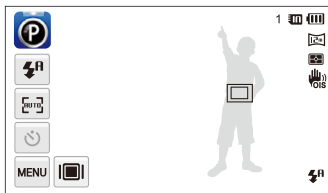

- The white frame means that your camera is tracking the subject.
- The green frame means that your subject is in focus when you half-press **[Shutter]**.



- If you do not touch any area on the screen, the focus frame will appear in the center of the screen.
- Tracking a subject may fail when:
 - the subject is too small
 - the subject moves excessively
 - the subject is backlit or you are shooting in a dark place
 - colors or patterns on the subject and the background are the same
 - the camera shakes excessively
- When tracking a subject fails, the focus frame will appear as a white single-line frame (□).
- If the camera fails to track the subject, you must reselect the subject to track.
- If the camera fails to focus, the focus frame will change to a red single-line frame (□).
- If you use this function, you cannot set Self Timer options, Face Detection options, and Smart Filter options.

Using one touch shooting

You can focus on a subject and capture a photo with the touch of your finger.

- 1 In Shooting mode, touch **MENU** → **Focus Area**.
- 2 Select **One Touch Shooting**, and then touch **OK**.
- 3 Touch a subject to capture the photo.

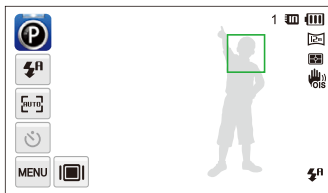





If you use this function, you cannot set Self Timer options, Burst options, and Smart Filter effects.

Adjusting the focus area

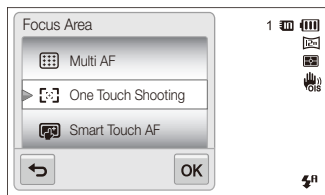
You can get clearer photos by selecting an appropriate focus area according to your subject's location in the scene.

- 1 In Shooting mode, touch **MENU** → **Focus Area**.
- 2 Select an option, and then touch **OK**.



Icon	Description
	Center AF: Focus on the center of the frame (suitable when subjects are located at or near the center).
	Multi AF: Focus on one or more of 9 possible areas.
	One Touch Shooting: Focus on the subject and capture a photo by touching the image on the screen. (p. 60)
	Smart Touch AF: Focus on and track the subject that you touch on the screen. (p. 59)

Using face detection

If you use Face Detection options, your camera can automatically detect a human face. When you focus on a human face, the camera adjusts the exposure automatically. Use **Blink Detection** to detect closed eyes or **Smile Shot** to capture a smiling face. You can also use **Smart Face Recognition** to register faces and prioritize the focus on them.



- The camera automatically tracks the registered face.
- Face Detection may not be effective when:
 - the subject is far from the camera (The focus frame will appear orange for Smile Shot and Blink Detection.)
 - it is too bright or too dark
 - the subject is not facing the camera
 - the subject is wearing sunglasses or a mask
 - the subject's facial expression changes drastically
 - the subject is backlit or the lighting conditions are unstable
- Face Detection is not available when you set Smart Filter effects or Smart Touch AF.
- Depending on the shooting options, available Face Detection options may differ.
- Depending on the Face Detection options you selected, the timer function may not be available or available timer options may differ.
- When you set Face Detection options, some Burst options are not available.
- When you capture photos of detected faces, they will be registered in the face list.
- You can view registered faces in order of priority in Playback mode. (p. 82) Even though faces are registered successfully, they may not be classified in Playback mode.
- A face detected in Shooting mode may not appear in the face list or Smart Album.

Detecting faces

Your camera automatically detects up to 10 human faces in one scene.

- 1 In Shooting mode, touch **MENU** → **Face Detection**.
- 2 Select **Normal**, and then touch **OK**.

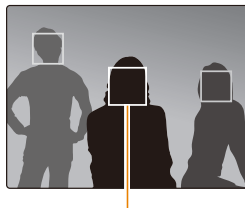

The nearest face appears in a white focus frame and the rest of the faces appear in gray focus frames.



- The closer you are to the subjects, the quicker your camera will detect faces.
- To focus on a subject in a gray focus frame, touch the face in the frame.
- The detected faces may not be registered if you set Burst options such as **Continuous**, **Motion Capture**, or **AEB**.

Capturing a self portrait shot

Capture photos of yourself. The focus distance will be set to close-up and your camera will emit a beep.

- 1 In Shooting mode, touch **MENU** → **Face Detection**.
- 2 Select **Self-Portrait**, and then touch **OK**.
- 3 When you hear a quick beep, press **[Shutter]**.

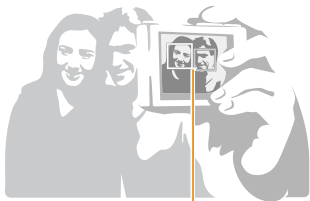

When faces are located in the center, the camera beeps rapidly.



If you turn **Volume** off in the sound settings, the camera will not emit a beep.
(p. 109)

Capturing a smile shot

The camera automatically releases the shutter when it detects a smiling face.

- 1 In Shooting mode, touch **MENU** → **Face Detection**.
- 2 Select **Smile Shot**, and then touch **OK**.
- 3 Compose your shot.
 - The camera automatically releases the shutter when it detects a smiling face.



When your subject smiles broadly, your camera can detect the smile more easily.

Detecting eye blinking

If your camera detects closed eyes, it will automatically capture 2 photos in succession.

- 1 In Shooting mode, touch **MENU** → **Face Detection**.
- 2 Select **Blink Detection**, and then touch **OK**.

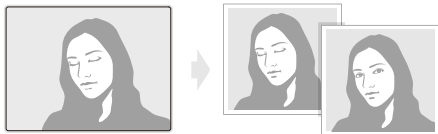

- Hold your camera still while **"Capturing"** is displayed on the screen.
- If Blink Detection fails, the **"Picture taken with eyes closed."** message appears. Capture another photo.



Using Smart Face Recognition

The camera automatically registers faces that you frequently photograph. The Smart Face Recognition feature will automatically prioritize the focus on those faces and on favorite faces. The Smart Face Recognition feature is available only when you use a memory card.

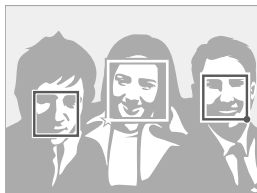
- 1 In Shooting mode, touch **MENU** → **Face Detection**.
- 2 Select **Smart Face Recognition**, and then touch **OK**.



The nearest face appears in a white focus frame and the rest of the faces appear in gray focus frames.

- : Faces that you have registered as favorites.
(To register faces as favorites, refer to page 65.)
- : Faces that the camera has automatically registered.



- The camera may recognize and register faces incorrectly depending on lighting conditions, drastic changes in the subject's pose or face, and whether or not the subject is wearing glasses.
- The camera can automatically register up to 14 faces. If the camera recognizes a new face when 14 faces have already been registered, it will replace the lowest priority face with the new one.
- The camera can detect up to 5 favorite faces in one scene.

Registering faces as your favorites (My Star)

You can register your favorite faces to prioritize the focus and exposure on those faces. This feature is available only when you use a memory card.

- 1 In Shooting mode, touch **MENU** → **Smart FR Edit**.
- 2 Select **My Star**, and then touch **OK**.
- 3 Align your subject's face with the oval guideline, and then press [**Shutter**] to register the face.

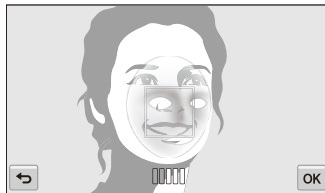

- If the subject's face is not aligned with the oval guideline, the white frame will not appear.
- Capture 5 photos of the subject's face: one each from the front, left, right, above, and below.
- Capture photos of one person at a time when registering faces.

4 Touch when the face list appears.

- Your favorite faces are indicated with a ★ on the face list.



- You can register up to 6 favorite faces.
- The flash will not fire when you register a favorite face.
- If you register the same face twice, you can delete one of the faces in the face list.

Viewing your favorite faces

1 In Shooting mode, touch  → **Smart FR Edit**.

2 Select **Face List**, and then touch **OK**.



- To change the ranking of your favorite faces, touch  (p. 82)
- To delete a favorite face, touch 

Adjusting brightness and color

Learn how to adjust the brightness and color for better image quality.

Adjusting the exposure manually (EV)

Depending on the intensity of the ambient light, your photos may be too bright or dark. In these cases, you can adjust the exposure to get a better photo.



Darker (-)



Neutral (0)



Brighter (+)



- Once you adjust the exposure, the setting will be stored automatically. You may need to change the exposure value later to avoid overexposure or underexposure.
- If you cannot decide on an appropriate exposure, select **AEB** (Auto Exposure Bracket). The camera will capture 3 consecutive photos, each with a different exposure: normal, underexposed, and overexposed. (p. 71)

- 1 In Shooting mode, touch **MENU** → **EV**.
- 2 Select a desired value, and then touch **OK**.
 - The photo will be brighter as exposure increases.
 - When you adjust the exposure value, the icon will appear as shown below.

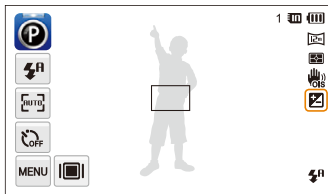

Compensating for backlighting (ACB)

When the light source is behind your subject or there is high contrast between your subject and the background, your subject is likely to appear dark in the photo. If this occurs, set the Auto Contrast Balance (ACB) option.

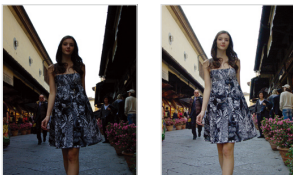

Without ACB

With ACB

- 1 In Shooting mode, touch **MENU**.
- 2 Touch the setting button next to **ACB**.

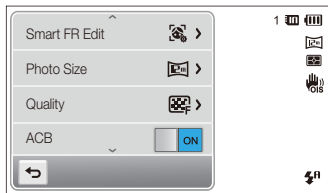





- The ACB feature is always on in Smart Auto, Scene (**Beach & Snow**) modes.
- The ACB feature is not available when you set **Continuous**, **Motion Capture**, or **AEB** options.

Changing the metering option

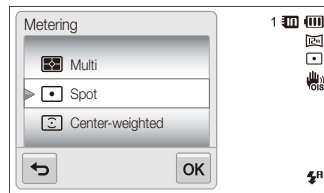
The metering mode refers to the way in which a camera measures the quantity of light. The brightness and lighting of your photos will vary depending on the metering mode you select.

- 1 In Shooting mode, touch **MENU** → **Metering**.
- 2 Select an option, and then touch **OK**.



Icon	Description
	<p>Multi:</p> <ul style="list-style-type: none"> Your camera divides the frame into several areas, and then measures the light intensity of each area. Suitable for general photos.
	<p>Spot:</p> <ul style="list-style-type: none"> Your camera measures only the light intensity of the very center of the frame. If a subject is not in the center of the frame, your photo may be improperly exposed. Suitable for a subject with backlighting.
	<p>Center-weighted:</p> <ul style="list-style-type: none"> Your camera averages the meter reading of the entire frame with emphasis placed on the center. Suitable for photos with subjects in the center of the frame.

Selecting a light source (White balance)

The color of your photo depends on the type and quality of the light source. If you want the color of your photo to be realistic, select a white balance setting that is appropriate for the lighting conditions, such as Auto WB, Daylight, Cloudy, or Tungsten.



 Auto WB



 Daylight



 Cloudy



 Tungsten

- 1 In Shooting mode, touch **MENU** → **White Balance**.
- 2 Select an option, and then touch **OK**.

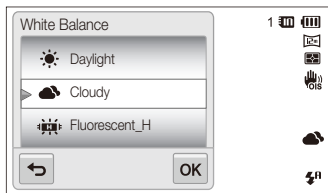

Icon	Description
	Auto WB: Automatically set the White Balance based on the lighting conditions.
	Daylight: For outdoor photos on a sunny day.
	Cloudy: For outdoor photos on a cloudy day or in shadows.
	Fluorescent_H: For shooting under a daylight fluorescent or 3-way fluorescent light.
	Fluorescent_L: For shooting under white fluorescent light.
	Tungsten: For shooting indoor photos under incandescent bulbs or halogen lamps.
	Custom Set: Use White Balance settings that you defined.

Defining your own White Balance

You can customize the White Balance by capturing a photo of a white surface, such as a piece of paper, under the lighting conditions in which you intend to capture a photo. The White Balance feature will help your camera reproduce the colors that are in the scene accurately in your photo.

- 1 In Shooting mode, touch **MENU** → **White Balance**.
- 2 Select **Custom Set**, and then touch **OK**.
- 3 Aim the lens at a piece of white paper, and then press **[Shutter]**.

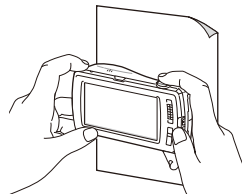

Using burst modes

It can be difficult to capture photos of fast-moving subjects or capture natural facial expressions and gestures of your subjects in photos. In these cases, select one of the burst modes to capture multiple photos rapidly.



- 1 In Shooting mode, touch **MENU** → **Drive**.
- 2 Select an option, and then touch **OK**.

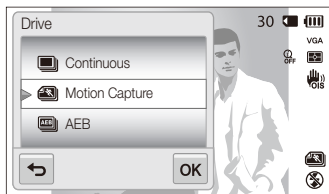

Icon	Description
	Single: Capture a single photo.
	Continuous: <ul style="list-style-type: none">• While you are pressing [Shutter], the camera continuously captures photos.• The maximum number of photos depends on the capacity of your memory card.
	Motion Capture: While you are pressing [Shutter], the camera captures VGA photos (6 photos per second; maximum of 30 photos).
	AEB: <ul style="list-style-type: none">• Captures 3 consecutive photos, each with a different exposure: normal, underexposed, and overexposed.• Use a tripod to prevent blurry photos.



- You can use the flash, timer, ACB, and Smart Filter only when you select **Single**.
- When you select **Motion Capture**, your camera will set the resolution to VGA and set the ISO sensitivity to **Auto**.
- Depending on the Face Detection option you selected, some Burst options may not be available.

Applying effects/Adjusting images

Applying Smart Filter effects

Apply various filter effects to your photos and videos to create unique images.



Miniature



Vignetting



Fish-eye





Sketch









- 1 In Shooting mode, touch **MENU** → **Smart Filter**.
- 2 Select a filter, and then touch **OK**.







Available filters in Program mode

Icon	Description
	Normal: No effect
	Miniature: Apply a tilt-shift effect to make the subject appear in miniature.
	Vignetting: Apply the retro-looking colors, high contrast, and strong vignette effect of Lomo cameras.
	Soft-Focus: Hide facial imperfections or apply dreamy effects.
	Old Film 1: Apply vintage film effect 1.
	Old Film 2: Apply vintage film effect 2.
	Half Tone Dot: Apply a halftone effect.
	Sketch: Apply a pen sketch effect.
	Fish-eye: Blacken the edges of the frame and distort objects to imitate the visual effect of a fisheye lens.
	Defog: Make a photo clearer.
	Classic: Apply a black and white effect.

Icon	Description
	Retro: Apply a sepia tone effect.
	Negative: Apply a negative film effect.
	Custom RGB: Customize a color value.

Available filters in Movie mode

Icon	Description
	Normal: No effect
	Palette Effect 1: Create a vivid look with sharp contrast and red color.
	Palette Effect 2: Make scenes clean and clear by applying a soft blue tone.
	Palette Effect 3: Apply a soft brown tone.
	Palette Effect 4: Create a cold and monotone effect.
	Miniature: Apply a tilt-shift effect to make the subject appear in miniature.
	Vignetting: Apply the retro-looking colors, high contrast, and strong vignette effect of Lomo cameras.
	Half Tone Dot: Apply a halftone effect.

Icon	Description
	Sketch: Apply a pen sketch effect.
	Fish-eye: Distort close objects to imitate the visual effect of a fisheye lens.
	Defog: Make the images clearer.
	Classic: Apply a black and white effect.
	Retro: Apply a sepia tone effect.
	Negative: Apply a negative film effect.
	Custom RGB: Customize a color value.

Defining your own RGB tone

- 1 In Shooting mode, touch **MENU** → **Smart Filter**.
- 2 Select **Custom RGB**, and then touch **OK**.
- 3 Drag up or down to adjust the values of each color.
 - The higher the value, the brighter the photo.
 - The lower the value, the darker the photo.

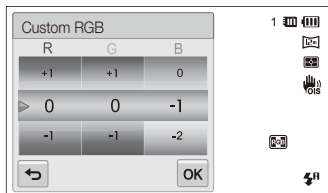

- 4 Touch **OK** to save your changes.



- If you select **Miniature** when you are recording a video, the speed of the video will increase.
- If you select **Miniature** when you are recording a video, the camera will not record sound.
- If you select **Miniature, Vignetting, Half Tone Dot, Sketch, Fish-eye,** or **Defog** while recording a video, the recording speed will be set to **1/15** and the recording resolution will be set to less than **640**.
- If you set Smart Filter effects, you cannot use the Face Recognition options, ACB, burst options, Image Adjustment options, Intelli zoom, or Smart Touch AF.
- If you select **Sketch** when you capture a photo, the photo resolution will change to **5m** and below.

Adjusting your photos

Adjust the sharpness, saturation, or contrast of your photos.

1 In Shooting mode, touch **MENU** → **Image Adjust**.

2 Drag up or down to adjust each value.

-  Sharpness
-  Contrast
-  Saturation

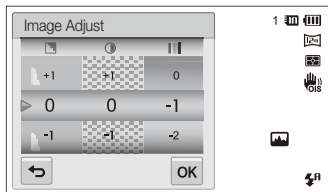

3 Touch **OK** to save your changes.

Sharpness	Description
-	Soften the edges on your photos (suitable for editing the photos on your computer).
+	Sharpen the edges to improve the clarity of your photos. This may also increase the noise on your photos.

Contrast	Description
-	Decrease the color and brightness.
+	Increase the color and brightness.

Saturation	Description
-	Decrease the saturation.
+	Increase the saturation.



- Select 0 if you do not want to apply any effects (suitable for printing).
- If you set adjustment functions, you cannot use Smart Filter options.

Reducing the sound of the zoom

When you use the zoom while recording videos, the camera can record the sound of the zoom in the videos. Use the Sound Alive function to reduce the zoom noise.

- 1 In Shooting mode, touch **MENU** → **Voice**.
- 2 Select an option, and then touch **OK**.

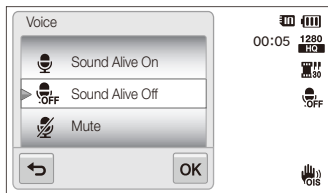

Icon	Description
	Sound Alive On: Turn on the Sound Alive function.
	Sound Alive Off: Turn off the Sound Alive function.
	Mute: Do not record sounds.



- Do not block the microphone when you use the Sound Alive function.
- Recordings made with Sound Alive may differ from actual sounds.

Available shooting options by shooting mode

For details about shooting options, refer to "Shooting options".

	Smart Auto	Simple Shot	Dual IS	Scene	Close Up	Night Shot	Beauty Shot	Program	Movie
Resolution	○	○	○	○	○	○	○	○	○
Quality	-	○	○	○	○	○	○	○	○
Timer	△	○	○	○	○	○	○	○	△
Flash	△	△	-	△	-	△	△	○	-
ISO sensitivity	-	-	-	-	-	-	-	○	-
Macro	△	△	-	△	△	-	△	○	○
Focus area	-	-	-	-	-	-	-	○	-
Face detection	△	-	-	△	-	-	△	○	-
EV	-	-	-	-	-	-	-	○	○
ACB	△	-	-	△	-	-	-	○	-
Metering	-	-	-	-	-	-	-	○	○
White balance	-	-	-	-	-	-	-	○	○
Drive	-	-	-	-	-	-	-	○	-
Smart filter	-	-	-	-	-	-	-	△	△
Image adjust	-	-	-	-	-	-	-	○	-
Sound Alive	-	-	-	-	-	-	-	-	○
Digital zoom	-	-	-	△	-	-	-	○	-
Intelli zoom	△	-	-	△	-	-	-	△	-
OIS	○	○	○	○	○	○	○	○	○
Voice memo	-	-	-	-	-	-	-	○	-

△ In these modes, some options are limited or a certain option is set by default. ○ All options are available.

Available shooting options by shooting mode

	Smart Movie	Object Highlight	Magic Frame shot	Photo Filter	Movie Filter	Vignetting (photo)	Vignetting (movie)	Palette Effect
Resolution	○	△	-	○	○	○	○	○
Quality	○	○	○	○	-	○	○	○
Timer	△	○	○	○	△	○	△	△
Flash	-	△	○	△	-	△	-	-
ISO sensitivity	-	-	-	-	-	-	-	-
Macro	△	-	-	-	△	-	△	△
Focus Area	-	-	-	-	-	-	-	-
Face detection	-	-	-	-	-	-	-	-
EV	-	-	-	-	-	-	-	-
ACB	-	-	-	-	-	-	-	-
Metering	-	-	-	-	-	-	-	-
White balance	-	-	-	-	-	-	-	-
Drive	-	-	-	-	-	-	-	-
Smart filter	-	-	-	△	△	-	-	△
Image adjust	-	-	-	-	-	-	-	-
Sound Alive	○	-	-	-	○	-	○	○
Digital zoom	-	-	-	-	-	-	-	-
Intelli zoom	-	-	-	-	-	-	-	-
OIS	○	○	○	○	○	○	○	○
Voice memo	-	-	-	-	-	-	-	-

△ In these modes, some options are limited or a certain option is set by default. ○ All options are available.

Playback/Editing

Learn how to play back photos, videos, or voice memos and edit photos or videos. Also, learn how to connect your camera to your computer, photo printer, TV, or HDTV.

Viewing photos or videos in Playback

mode	80
Starting Playback mode	80
Viewing photos	87
Playing a video	89
Playing a voice memo	91

Editing a photo	92
Resizing photos	92
Rotating a photo	93
Using Smart Crop	93
Applying Smart Filter effects	94
Adjusting your photos	94
Creating a print order (DPOF)	96

Viewing files on a TV or HDTV	97
--	----

Transferring files to your Windows

computer	99
Transferring files with Intelli-studio	100
Transferring files by connecting the camera as a removable disk	102
Disconnecting the camera (for Windows XP)	103

Transferring files to your Mac computer	104
--	-----

Printing photos with a PictBridge photo printer	105
--	-----

Viewing photos or videos in Playback mode

Learn how to play back photos, videos, or voice memos and how to manage files.

Starting Playback mode

View photos or play videos and voice memos stored in your camera.

1 Press **[Playback]**.

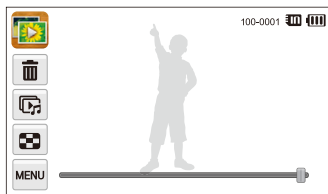

- The most recent file will be displayed.
- If the camera is off, it will turn on and display the most recent file.

 To view files by category, touch  on the Home screen. (p. 83)

2 Drag the image left or right to move to another file.

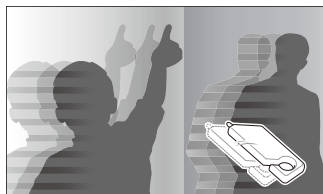

- To skip files quickly, tilt the camera in the direction you want to flip files. (p. 81)
- You can also touch and hold the left end or right end of the screen to skip files quickly.
- You can also drag the slider left or right to move to the previous or next file.

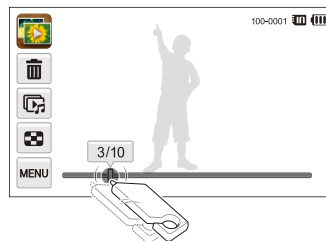



- If you want to view files stored in the internal memory, remove your memory card.
- The camera will not play back files of unsupported sizes or files that were captured with other cameras properly.

Viewing files with motion recognition

You can view files by tilting the camera in Playback mode.

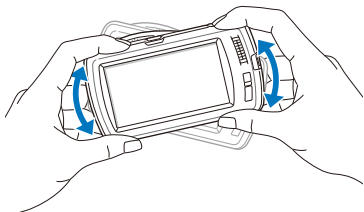

- Motion recognition may not work well if you hold the camera with the screen parallel to the ground.

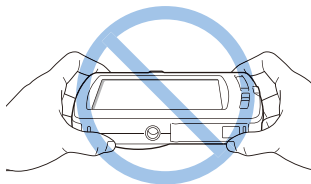

- When you rotate the camera 90° or 180° while you view a photo, the camera will automatically change the orientation of the displayed photo. (p. 112)
- To deactivate motion recognition, touch **MENU**, and then touch the setting button next to **Gesture View**.

Display in Playback mode

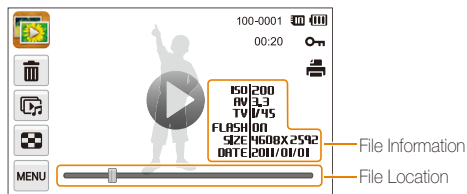

Icon	Description
	Photo includes a voice memo
	Play videos (p. 89) or voice memos (p. 91)
100-0001	Folder name – File name
00:20	Video length
	Protected file
	Print order has been set (DPOF)
	Delete files (p. 86)
	Play a slide show (p. 88)
	View files as thumbnails (p. 85)

To display file information on the screen, touch **MENU**, and then touch the setting button next to **File Information**.

Ranking your favorite faces

You can rank your favorite faces or delete them. The favorite face feature is available only when you insert a memory card into the camera.

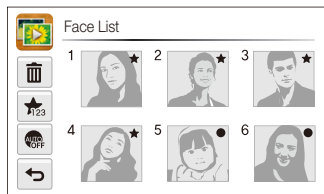

- In Playback mode, touch **MENU** → **Face List**.
 - In Thumbnail view or Smart album, touch **MENU** → **Face List**.

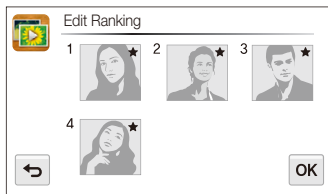

- To change the rank of a face, touch  → **Yes**, and then drag the face to a new location.



- Touch **OK** to save your changes.
 - To delete a face from the list, touch , touch the face, and then touch **OK**.



 Touch  to view only your favorite faces in the face list.

Viewing files in Smart album as thumbnails

View files by category, such as date, face, or file type.

- On the Home screen, touch .
- Touch **ALL** → a category option.



Icon	Description
	View all files.
	View files by the date they were saved.
	View files by recognized faces and favorite faces.
	View files by the file type.

-  • It may take some time for the camera to open Smart album, change the category, or reorganize files.
- If you delete a category, all files in the category will be deleted.

Viewing files in 3D view

- 1 On the Home screen, touch .
- 2 Drag images left or right to move to the previous or next file.
 - Flick the screen left or right to switch files more quickly. The faster you flick the screen, the more files you will scroll through at a time.

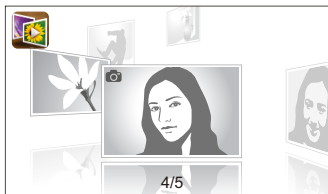





- You cannot play movies or voice memos in 3D view.
- The 3D feature is not available while the camera is connected to a TV.

Viewing files with the page flip effect

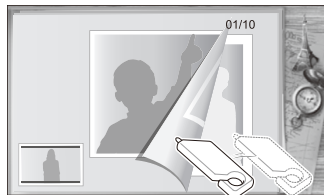
You can flip through files by dragging or flicking the touch pen across the screen. You can also run a slide show with the flip page effect by touching the slide show icon on the left side.

- 1 On the Home screen, touch .
- 2 Touch a theme (Travel, Wedding, or Party).
- 3 Drag images to the left or right to move to the previous or next file.



Icon	Description
	Play a slide show. <ul style="list-style-type: none"> • Touch the screen to pause the slide show and adjust the volume or mute the sound. • Touch  to stop the slide show.
	Return to the theme selection screen.

 You can view only photos when you use the page flip effect.

Viewing files as thumbnails

Scan thumbnails of files.





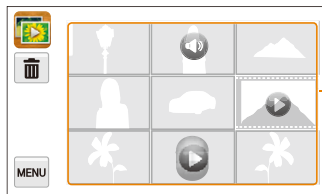

In Playback mode, push **[Zoom]** down to view thumbnails (9 at a time). Push **[Zoom]** down once or twice more to display more thumbnails (16 or 36 at a time).

Push **[Zoom]** up to return to the previous view.



Touch a file to display it in full screen view.

Icon	Description
	Delete files
	Photo includes a voice memo
	Video file
	Voice memo file

 Drag the screen up or down to move to the previous or next page of thumbnails.

Protecting files

Protect your files to prevent accidental deletion.

- 1 In Playback mode, locate the file you want to protect, and then touch **MENU**.
- 2 Touch the setting button next to **Protect**.

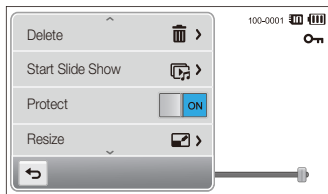

 You cannot delete or rotate a protected file.

Deleting files

Select files to delete in Playback mode.

Deleting a single file

You can select one file, and then delete it.

- 1 In Playback mode, locate the file you want to delete, and then touch **MENU**.
- 2 When the pop-up message appears, touch **Yes**.

 You can also delete a file by touching **MENU** → **Delete** → **Delete** → **OK** → **Yes**.

Deleting multiple files

You can select multiple files, and then delete them at once.

- 1 In Thumbnail view, touch **MENU**.
- 2 Select the files you want to delete, and then touch **MENU**.
- 3 When the pop-up message appears, touch **Yes**.

 When you sort files by category, deleting a category will delete all files in that category.

Deleting all files

You can select all files, and then delete them at once.

- 1 In Playback mode, touch **MENU** → **Delete**.
 - In Thumbnail view or Smart album, touch **MENU** → **Delete**.
- 2 Select **All**, and then touch **OK**.
- 3 When the pop-up message appears, touch **Yes**.

Copying files to a memory card

Copy files from the internal memory to a memory card.

- 1 In Playback mode, touch **MENU**.
 - In Thumbnail view or Smart album, touch **MENU** → **Copy to Card**.
- 2 Touch **Copy to Card**.
- 3 When the pop-up message appears, touch **Yes**.

Viewing photos

Enlarge part of a photo or view photos as a slide show.



Enlarging a photo



In Playback mode, push **[Zoom]** up to enlarge a portion of the photo. Push **[Zoom]** down to zoom out.



Drag the screen to see another part of the photo.





Icon	Description
	Delete the file.
	Crop the photo (the camera will save it as a new file).
	Return to the original view.
x2.0	Zoom ratio (The maximum zoom ratio differs depending on the photo resolution.)



When you view photos that were captured by another camera, the zoom ratio may differ.





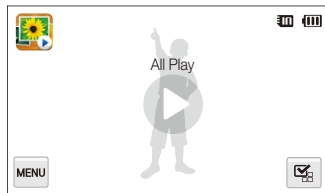

Playing a slide show

Apply effects and audio to a slide show of your photos. The slide show function does not work for videos or voice memos.



- 1 On the Home screen, touch . A picture appears.
- 2 Touch , on the bottom right of the screen. A screen with thumbnails appears.
- 3 Select the photos you want to include in your slide show.
 - Touch an individual photo to select it. Touch it again to deselect it.
 - Touch  to select all.
 - Touch  to cancel your selections.
 - You cannot select video files.
 - You can select up to 2,000 files.
- 4 Touch **OK**.
- 5 Touch , and then set a slide show effect.



* Default

Icon	Description
	Play Mode: Set whether or not to repeat the slide show. (One Play* , Repeat)
	Interval: <ul style="list-style-type: none"> Set the interval between photos. (1 sec*, 3 sec, 5 sec, 10 sec) You must set the Effect option to  to set the interval.
	Music: Set background audio. (Off* , Mist , Drops , Muse , Trip , Fall)
	Effect: <ul style="list-style-type: none"> Set a scene change effect between photos. (Off*, Calm, Shine, Relax, Lively, Sweet) Select  to cancel effects. When you use the Effect option, the interval between photos will be set to 1 second.

6 Touch  to start the slide show.





- Touch the screen to pause the slide show.
- Touch  to adjust the volume or mute the sound.
- Touch  to stop the slide show.

Playing a video

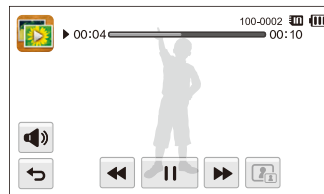

In Playback mode, you can view a video, and then capture or trim parts of the playing video. You can save the captured or trimmed segments as new files.

- 1 In Playback mode, locate a video, and then touch .
- 2 View the video.



Icon	Description
	Scan backward.
	Pause or resume playback.
	Scan forward.
	Adjust the volume or mute the sound.
	Return to Playback mode.

Trimming a video

- 1 While viewing a video, touch **||** at the point where you want the trimming to begin.
- 2 Touch  → .
- 3 Touch **||** at the point where you want the trimming to end.
 - You can also adjust the scene to be cropped by dragging the handles that appear on the progress bar.

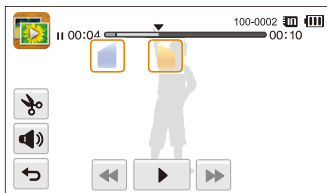

- 4 Touch .
- 5 When the pop-up message appears, touch **Yes**.

- The original video should be at least 10 seconds long.
- The camera will save the edited video as a new file.

Capturing an image from video

- 1 While viewing a video, touch **||** at the point where you want to capture an image.
- 2 Touch .
- 3 When the pop-up message appears, touch **Yes**.





- The resolution of the captured image will be the same as the original video.
- The captured image is saved as a new file.

Playing a voice memo

Listening to a voice memo

- 1 In Playback mode, locate a voice memo file, and then touch .
- 2 Listen to the voice memo.





Icon	Description
	Scan backward.
	Pause or resume playback.
	Scan forward.
	Adjust the volume or mute the sound.
	Return to Playback mode.

Playing voice memos that are attached to photos

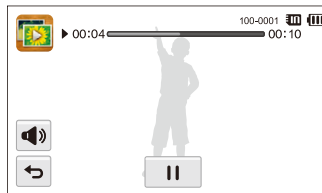
- 1 In Playback mode, locate a photo that includes a voice memo, and then touch .
- 2 Listen to the voice memo.



Icon	Description
	Pause or resume playback.
	Adjust the volume or mute the sound.
	Return to Playback mode.

Editing a photo

Learn how to edit photos.

- The camera will save edited photos as new files.
- When you edit photos, the camera will automatically convert them to a lower resolution. Photos that you rotate or resize manually are not automatically converted to a lower resolution. Rotated photos overwrite the original files.

Resizing photos

Change the size of a photo and save it as a new file. You can also select a photo to be displayed when the camera turns on.

- 1 In Playback mode, locate a photo, and then touch **MENU**.
- 2 Touch **Resize**, and then select a size option.
 - Select **Start Image** to save the photo as a start image.
(p. 109)

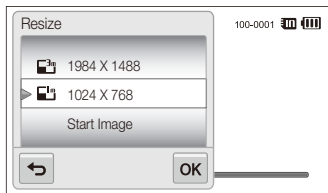

- 3 Touch **OK** to save.

- Available resize options differ depending on the original size of the photo.

Rotating a photo

- 1 In Playback mode, locate a photo, and then touch .
- 2 Touch **Rotate**, and then select a rotate option.

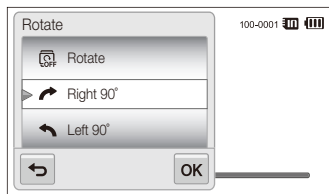

- 3 Touch **OK** to save.

 The camera will overwrite the original file.

Using Smart Crop

Use Smart Crop to select objects in a photo and save the cropped area as a new file.

- 1 In Playback mode, locate a photo, and then touch .
- 2 Touch **Smart Crop**.
- 3 Touch 4 points on the screen to select an area.
 - You can re-select the area by dragging the 4 points.

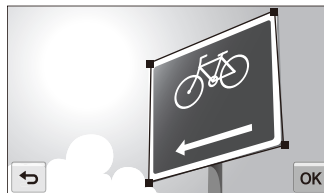



- 4 Touch **OK** to save.
 - The cropped photo is saved as a new file.



 The size of the new file may be smaller than the original.

Applying Smart Filter effects

Apply special effects to your photos.

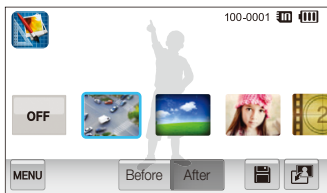
- 1 On the Home screen, touch .
 - The most recent file will be displayed.
- 2 Touch  → a photo.
- 3 Touch  → **Smart Filter**.
- 4 Select a filter.
 - To see available filter options, refer to page 72.
 - To view the original photo, touch **Before**.
 - To view the photo with the filter effect, touch **After**.



- 5 Touch  to save your changes or touch  to exit without saving.



Adjusting your photos



Learn how to adjust the brightness, contrast, or saturation and how to correct the red-eye effect. If the center of a photo is dark, you can adjust it to be brighter. The camera will save an edited photo as a new file, but may convert it to a lower resolution.



- You can adjust brightness, contrast, and saturation and apply Smart Filter effects at the same time.
- You cannot apply the ACB, Face Retouch, and Red-eye Fix effects at the same time.



Adjusting brightness, contrast, or saturation

- 1 On the Home screen, touch .
 - The most recent file will be displayed.
- 2 Touch  → a photo.
- 3 Touch  → an adjusting option.



Icon	Description
	Brightness
	Contrast
	Saturation

- 4 Drag the slider left or right to adjust the option.
 - To view the original photo, touch **Before**.
 - To view the adjusted photo, touch **After**.
- 5 Touch  to save your changes.





Adjusting dark subjects (ACB)

- 1 On the Home screen, touch 
 - The most recent file will be displayed.
- 2 Touch  → a photo.
- 3 Touch  → **ACB**.
 - To view the original photo, touch **Before**.
 - To view the adjusted photo, touch **After**.
- 4 Touch  to save your changes.

Retouching faces

- 1 On the Home screen, touch 
 - The most recent file will be displayed.
- 2 Touch  → a photo.
- 3 Touch  → **Face Retouch**.
- 4 Drag the slider to the left (darker) or right (lighter) to adjust the skin tone.
 - As the slider moves to the right, the skin tone becomes brighter.
 - To view the original photo, touch **Before**.
 - To view the adjusted photo, touch **After**.
- 5 Touch  to save your changes.

Removing red-eye

- 1 On the Home screen, touch .
 - The most recent file will be displayed.
- 2 Touch  → a photo.
- 3 Touch  → **Red-eye Fix**.
 - To view the original photo, touch **Before**.
 - To view the adjusted photo, touch **After**.
- 4 Touch  to save your changes.

Creating a print order (DPOF)

Select photos to print and save print options in the Digital Print Order Format (DPOF). This information is saved in the MISC folder on your memory card for convenient printing on DPOF-compatible printers.

- 1 In Playback mode, locate a photo, and then touch .
- 2 Touch **DPOF**.

- 3 Touch **+/-** to select the number of copies, and then touch **OK**.

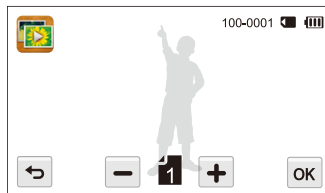

- You can take the memory card to a print shop that supports DPOF (Digital Print Order Format) or you can print photos directly through a DPOF-compatible printer at home.
- Photos with dimensions that are wider than the paper may be cut off on the left and right edges. Ensure that your photo dimensions are compatible with the paper you select.
- You cannot set DPOF options for photos stored in the internal memory.

Viewing files on a TV or HDTV

Play back photos or videos by connecting your camera to a TV with the A/V cable.

- 1 On the Home screen, touch .
- 2 Touch **Connectivity** → **Video Out**.
- 3 Select the appropriate video signal output for your country or region. (p. 110)
- 4 Turn off your camera and TV.
- 5 Connect your camera to your TV with the A/V cable.

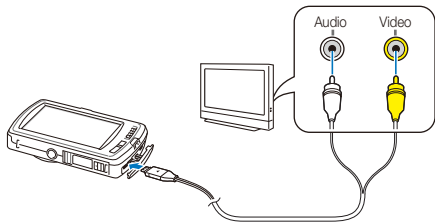

- 6 Turn on your TV, and then select a video output mode and the video source (AV 1, etc.) with the TV remote control.

- 7 Turn on your camera.
 - The camera automatically enters into Playback mode when you connect it to a TV.
- 8 View photos or play videos using the touch screen on your camera.



- Depending on the TV model, you may see some digital noise or part of an image may not appear.
- The camera automatically enters Playback mode when you connect it to a TV.

Viewing files on an HDTV

You can view high-quality and uncompressed photos or videos on an HDTV using the optional HDMI cable. HDMI (High Definition Multimedia Interface) is supported by most HDTVs. For details, see the HDMI Kit manual.

- 1 On the Home screen, touch .
- 2 Touch **Connectivity** → **HDMI Output**.
- 3 Select an HDMI resolution.
- 4 Turn off your camera and HDTV.
- 5 Connect your camera to your HDTV using an optional HDMI cable.

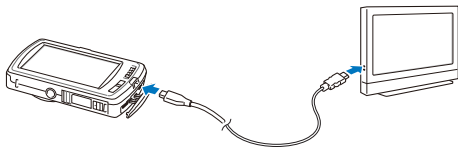

- 6 Turn on your camera and your TV.
 - If you have an Anynet+ compatible Samsung HDTV, the HDTV will turn on automatically and display the camera screen.
 - If you turn Anynet+ off, the HDTV does not turn on automatically.
- 7 If your TV does not have Anynet +, use your TV remote to select the video source (HDMI 1, HDMI2, etc.).
- 8 View files using the touch screen on your camera. If you have Anynet+, you can use your TV's remote.



- If your HDTV supports the Anynet+(CEC) profile, turn Anynet+ on in the camera's settings menu (p.110) to control the camera and TV with the TV's remote control.
- Anynet+ lets you control all connected Samsung A/V devices with the TV remote control.
- The time it takes for the camera to connect to your HDTV may vary with the type of microSD or microSDHC card you use. A faster microSD or microSDHC card will not necessarily result in a faster HDMI transfer, because the main function of the card is to improve transfer rates during shooting.

Transferring files to your Windows computer

Transfer files to your Windows computer, edit them with Intelli-studio, and upload them to the web.

Requirements

Item	Requirements
CPU	Intel Pentium 4, 3.2 GHz or higher/AMD Athlon™ FX 2.6 GHz or higher
RAM	Minimum 512 MB RAM (1 GB or more recommended)
OS	Windows XP SP2, Windows Vista, or Windows 7 (32-bit editions)
Hard disk capacity	250 MB or more (1 GB and above recommended)
Others	<ul style="list-style-type: none">• CD-ROM drive• 1024 X 768 pixels, 16-bit color display compatible monitor (1280 X 1024 pixels, 32-bit color display recommended)• USB 2.0 port• nVIDIA Geforce 7600GT or higher/ATI X1600 series or higher• Microsoft DirectX 9.0c or higher

* The programs may not work properly on 64-bit editions of Windows XP, Windows Vista, and Windows 7.



- The requirements are recommendation only. Intelli-studio may not work properly even when the computer meets the requirements, depending on the condition of your computer.
- If your computer does not meet the requirements, videos may not play correctly or it may take longer to edit videos.
- Install DirectX 9.0c or above before you use the program.
- Your computer must be running Windows XP, Windows Vista, or Windows 7 for you to connect the camera as a removable disk. (p. 102 and p. 99)





Samsung is not responsible for any damage that results from using a computer that do not meet the requirements such as a computer you have assembled yourself.

Transferring files with Intelli-studio

Intelli-studio will start automatically when you connect the camera to your computer with the USB cable.

 The battery will charge while the camera is connected to a computer with the USB cable.

- 1 On the Home screen, touch .
- 2 Touch **Connectivity**, and then turn on **PC Software** by touching the setting button.
- 3 Turn off the camera.
- 4 Connect the camera to your computer with the USB cable.

 You must plug the end of the cable with the indicator light (▲) into your camera. If the cable is reversed, it may damage your files. The manufacturer is not responsible for any loss of data.

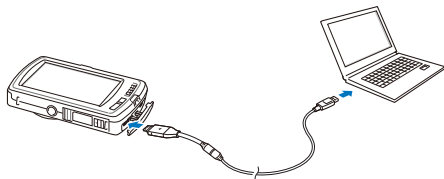

- 5 Turn on the camera.

- The computer recognizes the camera automatically and Intelli-studio launches automatically.

 If you set the USB option to **Select Mode**, select **Computer** in the pop-up window.

- 6 Select a destination folder on your computer, and then select **Yes**.

- New files stored on the camera will automatically transfer to the selected folder.
- If your camera has no new files, the pop-up window for saving new files will not appear.

 For Windows Vista and Windows 7, select **Run iStudio.exe** from the Auto Play window to start Intelli-studio.

Using Intelli-studio

Intelli-studio is a built-in program that allows you to play back and edit files. For details, select **Help** → **Help** on the program toolbar.

- To enjoy more features, such as creating slide shows with templates, install the full version of Intelli-studio by selecting **Web Support** → **Update Intelli-studio** → **Start Update** from the program toolbar.
- You can update the firmware of your camera by selecting **Web Support** → **Upgrade firmware for the connected device** from the program toolbar.
- If you install Intelli-studio on your computer, the program will launch more quickly. To install the program, select **Tool** → **Install Intelli-studio on PC**.
- You cannot edit files directly on the camera. Transfer files to a folder on your computer before editing.
- Intelli-studio supports the following formats:
 - Videos: MP4 (Video: H.264, Audio: AAC), WMV (WMV 7/8/9), AVI (MUPEG)
 - Photos: JPG, GIF, BMP, PNG, TIFF



No.	Description
1	Open menus.
2	Display files in the selected folder.
3	Switch to the Photo edit mode.
4	Switch to the Video edit mode.
5	Switch to the Sharing mode. (to send files by email or upload files to websites, such as Flickr or YouTube)
6	Enlarge or reduce the thumbnails in the list.
7	Select a file type.
8	View files in the selected folder on your computer.
9	Show or hide files on the connected camera.
10	View files in the selected folder on the camera.
11	View files as thumbnails or on a map.
12	Browse folders stored on the camera.
13	Browse folders stored on your computer.
14	Move to the previous or next folder.
15	Print files, view files on a map, store files in My Folder, or register faces.

Transferring files by connecting the camera as a removable disk

Connect the camera to your Windows computer as a removable disk.

- 1 On the Home screen, touch .
- 2 Touch **Connectivity**, and then turn off **PC Software** by touching the setting button.
- 3 Turn off the camera.
- 4 Connect the camera to your computer with the USB cable.



You must plug the end of the cable with the indicator light (▲) into your camera. If the cable is reversed, it may damage your files. The manufacturer is not responsible for any loss of data.

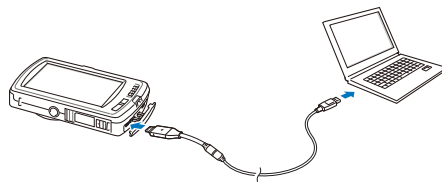

5 Turn on the camera.

- The computer recognizes the camera automatically.



If you set the USB option to **Select Mode**, select **Computer** in the pop-up window.

6 On your computer, select **My Computer** → **Removable Disk** → **DCIM** → **100PHOTO**.

7 Drag or save files to your computer.

Disconnecting the camera (for Windows XP)

For Windows Vista and Windows 7, the methods for disconnecting the camera are similar.

- 1 If the status lamp on your camera is blinking, wait until it stops.
- 2 Click  on the tool bar at the bottom right of your computer screen.



- 3 Click the pop-up message.
- 4 Click the message box indicating safely removed.
- 5 Remove the USB cable.



The camera may not disconnect safely while Intelli-studio is running. End the program before disconnecting the camera.

Transferring files to your Mac computer

When you connect the camera to a Macintosh computer, the computer will automatically recognize the device. You can transfer files directly from the camera to the computer without installing any programs.

 Mac OS 10.4 or later is supported.

1 Connect your camera to a Macintosh computer with the USB cable.

 You must plug the end of the cable with the indicator light (▲) into your camera. If the cable is reversed, it may damage your files. The manufacturer is not responsible for any loss of data.

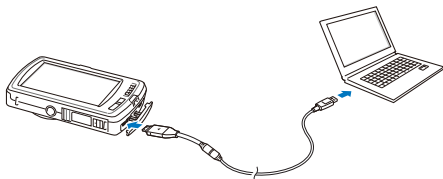

2 Turn on the camera.

- The computer recognizes the camera automatically and displays a removable disk icon.

 If you set the USB option to **Select Mode**, select **Computer** in the pop-up window.

3 Double-click the removable disk icon.

4 Drag or save files to your computer.

Printing photos with a PictBridge photo printer

Print photos with a PictBridge compatible printer by connecting your camera directly to the printer.

- 1 On the Home screen, touch .
- 2 Touch **Connectivity** → **USB** → **Printer**.
- 3 Turn on the printer, and then connect your camera to the printer with the USB cable.

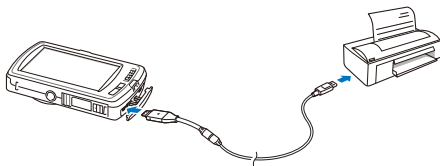

- 4 If the camera is off, press **[POWER]** or **[Playback]** to turn it on.
 - The printer recognizes the camera automatically.
- 5 Select a file to print.
- 6 Touch **+/-** to select the number of copies.
 - To set printer options, touch **MENU**. (p. 106)

- 7 Touch  to print.
 - Touch  to print all photos.

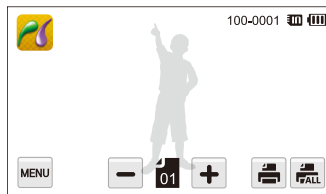

- 8 When the pop-up window appears, touch **Yes** to begin printing.
 - To cancel printing, touch **Cancel** on the pop-up window.

Configuring print settings

Press **MEMO** to configure print settings.

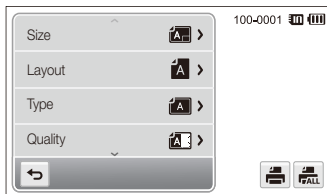

Icon	Description
	Size: Set the print size.
	Layout: Set the number of photos to be printed on a single sheet of paper.
	Type: Set the type of paper.
	Quality: Set the print quality.
	Date: Set to print the date.
	File Name: Set to print the file name.
	Reset: Reset settings to their default values.



Some options may not be supported by some printers.

Settings

Refer to options to configure your camera's settings.

Settings menu	108
Accessing the settings menu	108
Sound	109
Display	109
Connectivity	110
General	111





Settings menu

Learn to configure your camera's settings.

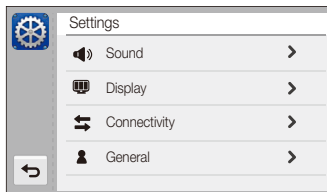
Accessing the settings menu

- 1 On the Home screen, touch .
- 2 Touch a menu.



Icon	Description
	Sound: Set various camera sounds and the volume. (p. 109)
	Display: Customize the display settings. (p. 109)
	Connectivity: Set the connection options. (p. 110)
	General: Change the settings for the camera system such as memory format and default file name. (p. 111)

- 3 Touch an item.

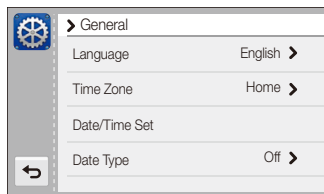

- 4 Select an option, and then touch **OK**.

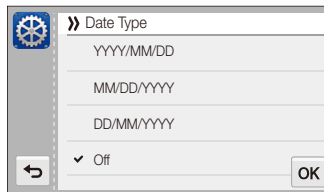

- 5 Touch  to return to the previous screen.

Sound

* Default



Item	Description
Volume	Set the volume of any sound. (Off , Low , Medium* , High)
Beep Sound	Set to emit sounds when you touch the screen or switch modes. (Off , On*)
Shutter Sound	Set the sound the camera emits when you press the shutter button. (Off , 1* , 2 , 3)
Start Sound	Set the sound the camera emits when you turn on your camera. (Off* , 1 , 2 , 3)
AF Sound	Set to emit a sound when you half-press the shutter button. (Off , On*)

Display

* Default

Item	Description
Start Image	<p>Set a start image to display when the camera turns on.</p> <ul style="list-style-type: none"> • Off*: Display no start image. • Logo: Display a default image stored in the internal memory. • User Image: Display a custom image. (p. 92) <p> • The camera will save only one User Start Image in the internal memory at a time.</p> <ul style="list-style-type: none"> • If you select a new photo as a User Start Image or reset your camera, the camera will delete the current image.
Guide Line	<p>Set a grid to help you compose a scene. (2 X 2*, 3 X 3, X, +)</p>

* Default

Item	Description
Display Brightness	Adjust the brightness of the screen. (Auto*, Dark, Normal, Bright)  Normal is fixed in Playback mode even if you have selected Auto .
Quick View	Set the duration for reviewing a captured image before returning to the Shooting mode. (Off, 0.5 sec*, 1 sec, 3 sec)
Power Save	If you perform no operations for 30 seconds, the camera automatically switches to Power save mode. (Off*, On)  <ul style="list-style-type: none"> In Power save mode, press any button other than [POWER] to resume using the camera. Even if you do not set the Power save mode, the screen will dim 30 seconds after the last operation to save power.

Connectivity

* Default

Item	Description
Video Out	Set the video signal output for your region. <ul style="list-style-type: none"> NTSC*: USA, Canada, Japan, Korea, Taiwan, Mexico PAL (supports only BDGHI): Australia, Austria, Belgium, China, Denmark, England, Finland, Germany, Italy, Kuwait, Malaysia, Netherlands, New Zealand, Norway, Singapore, Spain, Sweden, Switzerland, Thailand
Anynet+ (HDMI-CEC)	Set whether or not to control the camera with a TV remote control when you connect it to an HDTV that supports the Anynet+(CEC) profile. <ul style="list-style-type: none"> Off: View files without using an HDTV remote control. On*: Control the camera with an HDTV remote control.

* Default

Item	Description
HDMI Output	<p>Set the resolution of photos when the camera plays back files on an HDTV via the HDMI cable. (NTSC: 1080i*, 720p, 480p/PAL: 1080i*, 720p, 576p)</p> <p> • If the HDTV does not support the selected resolution, the HDTV automatically selects the next lower resolution.</p> <ul style="list-style-type: none"> • If you select 480p or 576p, the playback menus and Smart Album will not be available when you connect the camera to a TV.
USB	<p>Select the mode to use when you connect the camera to a computer or printer with a USB cable.</p> <ul style="list-style-type: none"> • Computer*: Connect your camera to a computer to transfer files. • Printer: Connect your camera to a printer to print files. • Select Mode: Manually select the USB mode when you connect your camera to a device.
PC Software	<p>Set Intelli-studio to launch automatically when you connect your camera to your computer. (Off, On*)</p>

General



* Default

Item	Description
Language	Set a language for the display text.
Time Zone	Set the time zone for your location. When you travel to another country, touch Visit , and then touch the appropriate time zone.
Date/Time Set	Set the date and time.
Date Type	Set a date format. (YYYY/MM/DD , MM/DD/YYYY , DD/MM/YYYY , Off*)

* Default

Item	Description
File No.	<p>Specify how to name files.</p> <ul style="list-style-type: none"> • Reset: Set the file number to start from 0001 when you insert a new memory card, format a memory card, or delete all files. • Series*: Set the file number to resume from the previous file number when you insert a new memory card, format a memory card, or delete all files. <p> • The default name of the first folder is 100PHOTO and the default name of the first file is SAM_0001.</p> <ul style="list-style-type: none"> • The file number increases one at a time from SAM_0001 to SAM_9999. • The folder number increases one at a time from 100PHOTO to 999PHOTO. • The maximum number of files that can be stored in one folder is 9,999. • The camera defines file names according to the Design rule for Camera File system (DCF) standard. If you intentionally change file names, the camera may not play back the files.

* Default

Item	Description
Auto Rotate	Set to automatically rotate photos as you rotate the camera. (Off, On*)
Imprint	<p>Set to display the date and time on captured photos. (Off*, Date, Date & Time)</p> <p> • The date and time will be displayed on the bottom right corner of the photo.</p> <ul style="list-style-type: none"> • Some printer models may not print the date and time properly. • If you select Text in Scene mode, the camera will not display the date and time.
Auto Power Off	<p>Set the camera to automatically turn off when you perform no operations for a specified period. (Off, 1 min, 3 min*, 5 min, 10 min)</p> <p> • Your settings will not change when you replace the battery.</p> <ul style="list-style-type: none"> • The camera will not automatically turn off when the camera is connected to a computer or printer, when you are playing a slide show or videos, and when you are recording a voice memo.

* Default

Item	Description
AF Lamp	Set a light to automatically turn on in dark places to help the camera focus. (Off, On*)
Format	Format the internal memory and the memory card. Formatting will delete all files, including protected files. (Yes, No)  Errors can occur if you use a memory card formatted by another brand of camera, a memory card reader, or a computer. Please format memory cards in the camera before using them to capture photos.
Reset	Reset menus and shooting options except date and time, language, and video output settings. (Yes, No)
Touch Calibration	Calibrate the touch screen so that your camera will properly recognize your inputs.

Appendixes

Get information about error messages, specifications, and maintenance.

Error messages	115
Camera maintenance	116
Cleaning your camera	116
Using or storing the camera	117
About memory cards	118
About the battery	120
Before contacting a service center	124
Camera specifications	127
Glossary	131
FCC notice	136
Index	137

Error messages

When the following error messages appear, try these remedies.

Error message	Suggested remedies
Card Error	<ul style="list-style-type: none">• Turn off your camera, and then turn it on again.• Remove your memory card, and then insert it again.• Format your memory card.
Card not supported.	The inserted memory card is not supported by your camera. Insert a microSD or microSDHC memory card.
DCF Full Error	File names do not match the DCF standard. Transfer the files on the memory card to your computer, and then format the card.
File Error	Delete the damaged file or contact a service center.
File system not supported.	Your camera does not support the FAT file structure of the inserted memory card. Format the memory card on the camera.
Low Battery	Insert a charged battery or recharge the battery.
Memory Full	Delete unnecessary files or insert a new memory card.
No Image File	Capture photos or insert a memory card that contains some photos.

Camera maintenance

Cleaning your camera

Camera lens and touch screen

Use a blower brush to remove dust and wipe the lens gently with a soft cloth. If any dust remains, apply lens cleaning liquid to a piece of lens cleaning paper and wipe gently.

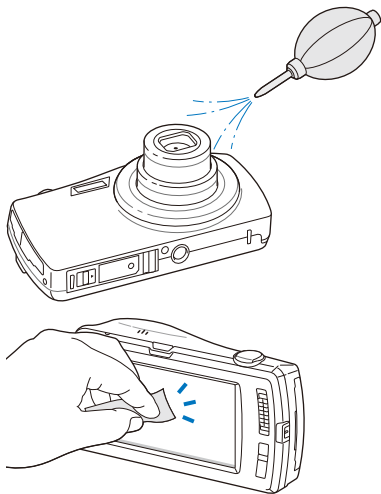

Camera body

Wipe gently with a soft, dry cloth.

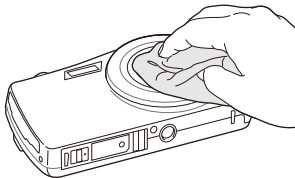

- Never use benzene, thinners, or alcohol to clean the camera. These solutions can damage the camera or cause it to malfunction.
- Do not press on the lens cover or use a blower brush on the lens cover.

Using or storing the camera

Inappropriate places to use or store the camera

- Avoid exposing the camera to very cold or very hot temperatures.
- Avoid using your camera in areas with extremely high humidity, or where the humidity changes drastically.
- Avoid exposing the camera to direct sunlight and storing it in hot, poorly-ventilated areas, such as in a car during summertime.
- Protect your camera and the display from impact, rough handling, and excessive vibration to avoid serious damage.
- Avoid using or storing your camera in dusty, dirty, humid, or poorly-ventilated areas to prevent damage to moving parts and internal components.
- Do not use your camera near fuels, combustibles, or flammable chemicals. Do not store or carry flammable liquids, gases, or explosive materials in the same compartment as the camera or its accessories.
- Do not store the camera where there are mothballs.

Using on beaches or shores

- Protect your camera from sand and dirt when you use it on beaches or in other similar areas.
- Your camera is not waterproof. Do not handle the battery, adapter, or memory card with wet hands. Operating the camera with wet hands may cause damage to your camera.

Storing for extended period of time

- When you store the camera for an extended period, place it in a sealed container with an absorbent material, such as silica gel.
- Remove the batteries from your camera when storing it for an extended period. Installed batteries may leak or corrode over time and cause serious damage to your camera.
- Over time, unused batteries will discharge and must be recharged before use.

Use the camera with caution in humid environments

When you transfer the camera from a cold environment to a warm one, condensation can form on the lens or internal components of the camera. In this situation, turn off the camera and wait for at least 1 hour. If condensation forms on the memory card, remove the memory card from the camera and wait until all moisture has evaporated before reinserting it.

Other cautions

- Do not swing your camera by the strap. This may cause injury to yourself or others or damage to your camera.
- Do not paint your camera, as paint can clog moving parts and prevent proper operation.
- Turn off the camera while not in use.
- Your camera consists of delicate parts. Avoid impacts to the camera.
- Protect the display from external force by keeping it in the case when not in use. Protect the camera from scratches by keeping it away from sand, sharp implements, or loose change.
- Do not expose the lens to direct sunlight, as this may discolor the image sensor or cause it to malfunction.
- Protect your lens from fingerprints and scratches. Clean your lens with a soft, clean, debris-free lens cloth.
- The camera may turn off if subjected to a sudden impact. This is to protect the memory card. Turn on the camera to use it again.
- While you use the camera, it may heat up. This is normal and should not affect your camera's lifespan or performance.
- When you use the camera in low temperatures, it may take some time to turn on, the screen color may be changed temporarily, or after-images may appear. These conditions are not malfunctions and they will correct themselves when the camera is returned to normal temperatures.

- Paint or metal on the outside of the camera may cause allergies, itchy skin, eczema, or swelling for people with sensitive skin. If you experience any of these symptoms, stop using the camera immediately and consult a doctor.
- Do not insert foreign objects into any of your camera's compartments, slots, or access points. Damage due to improper use may not be covered by your warranty.
- Do not allow unqualified personnel to service the camera or attempt to service the camera yourself. Any damage that results from unqualified service is not covered by your warranty.

About memory cards

Supported memory cards



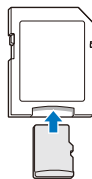









Your camera supports microSD (Secure Digital) or microSDHC (Secure Digital High Capacity) memory cards.



To read data with a PC or memory card reader, insert the memory card into a memory card adapter.

Memory card capacity

The memory capacity may vary depending on the scenes you shoot and the shooting conditions. The capacities below are based on a 1 GB microSD card:

	Size	Super Fine	Fine	Normal	30 FPS	15 FPS
P h o t o s	 16m	105	206	303	-	-
	 7m	117	230	337	-	-
	 5m	140	275	406	-	-
	 10m	166	323	469	-	-
	 5m	319	607	858	-	-
	 3m	522	954	1,336	-	-
	 2m	742	1,336	1,878	-	-
	 1m	1,582	2,505	3,006	-	-
* V i d e o s	 1280 HQ	-	-	-	Approx. 13' 08"	Approx. 22' 57"
	 1280	-	-	-	Approx. 14' 55"	Approx. 25' 54"
	 640	-	-	-	Approx. 34' 55"	Approx. 65' 40"
	 320	-	-	-	Approx. 134' 34"	Approx. 231' 14"

* Available recording time may vary if you use the zoom. Several videos were recorded in succession to determine the total recording time.

Cautions when using memory cards

- Insert a memory card in the correct direction. Inserting a memory card in the wrong direction may damage your camera and memory card.
- Do not use memory cards that have been formatted by other cameras or by a computer. Reformat the memory card with your camera.
- Turn off the camera when you insert or remove the memory card.
- Do not remove the memory card or turn off your camera while the lamp is blinking, as this may damage your data.
- When the lifespan of a memory card has expired, you cannot store any more photos on the card. Use a new memory card.
- Do not bend, drop, or subject memory cards to heavy impact or pressure.
- Avoid using or storing memory cards near strong magnetic fields.
- Avoid using or keeping memory cards in areas with high temperature, high humidity, or corrosive substances.
- Prevent memory cards from making contact with liquids, dirt, or foreign substances. If dirty, wipe the memory card clean with a soft cloth before you insert the memory card in your camera.
- Do not allow liquids, dirt, or foreign substances to come in contact with memory cards or the memory card slot. Doing so may cause memory cards or the camera to malfunction.

- When you carry a memory card, use a case to protect the card from electrostatic discharges.
- Transfer important data to other media, such as a hard disk, CD, or DVD.
- When you use the camera for an extended period, the memory card may become warm. This is normal and does not indicate a malfunction.



The manufacturer is not responsible for any loss of data.

About the battery

Use only Samsung-approved batteries.

Battery specifications

Specification	Description
Model	BP70A
Type	Lithium-ion battery
Cell capacity	740 mAh (min. 700 mAh)
Voltage	3.7 V
Charging time* (when the camera is switched off)	Approximately 150 min

* Charging the battery by connecting it to a computer may take longer.

Battery life

Average shooting time / Number of photos		Test conditions and procedures (when the battery is fully charged)
Photos	Approximately 95 min/ Approximately 190 photos	<p>This is measured under the following conditions: in Program mode, in the darkness, at 4K resolution, with OIS off, Fine quality.</p> <p>Procedure:</p> <ol style="list-style-type: none"> 1. Set the flash option to Fill in, take a single shot, and zoom in or out. 2. Set the flash option to Off, take a single shot, and zoom in or out. 3. Perform steps 1 and 2 for 30 seconds and repeat for 5 minutes. Then turn off the camera for 1 minute. 4. Repeat steps 1 to 3.
Videos	Approximately 70 min	Record videos at 1280 X 720 HQ resolution and 30 FPS.

- The figures above are measured using Samsung's standards. Your results may vary, depending on your actual usage
- Several videos were recorded in succession to determine the total recording time.

Low battery message

When the battery has fully discharged, the battery icon will turn red and the "Low Battery" message will appear.

Notes about using the battery

- Avoid exposing batteries or memory cards to very cold or very hot temperatures (below 0 °C/32 °F or above 40 °C/104 °F). Extreme temperatures can reduce the charging capacity of your batteries and can cause memory cards to malfunction.
- When you use the camera for an extended period, the area around the battery chamber may become warm. This does not affect the normal use of the camera.
- Do not pull the power supply cord to disconnect the plug from the power outlet, as this may cause a fire or electric shock.
- In temperatures below 0 °C/32 °F, battery capacity and battery life may decrease.
- Battery capacity may decrease in low temperatures but will return to normal in milder temperatures.

Cautions about using the battery

Protect batteries, chargers, and memory cards from damage

Prevent batteries from making contact with metal objects. Contact can create a connection between the + and – terminals of your battery and lead to temporary or permanent battery damage and may cause a fire or electric shock.

Notes about charging the battery

- If the indicator light is off, make sure that the battery is inserted correctly.
- If the camera is on while the battery is charging, the battery may not fully charge. Turn off the camera before charging the battery.
- Do not use your camera when you are charging the battery. This may cause a fire or electric shock.
- Do not pull the power supply cord to disconnect the plug from the power outlet. This may cause a fire or electric shock.
- Let the battery charge for at least 10 minutes before turning on the camera again.
- If you connect the camera to an external power source when the battery is depleted, using some high energy-consuming functions will cause the camera to turn off. To use the camera normally, recharge the battery.

- Using the flash or recording videos depletes the battery quickly. Charge the battery until the indicator light turns green.
- If the indicator light blinks in orange or does not illuminate, reconnect the cable, or remove the battery and insert it again.
- If you charge the battery when the cable is overheated or the temperature is too high, the indicator light may turn orange. Charging will start when the battery cools down.
- Overcharging batteries may shorten battery life. After charging is finished, disconnect the cable from your camera.
- Do not bend or place heavy objects on the AC cable. Doing so may damage the cable.

Notes about charging with a computer connected

- Use only the provided USB cable.
- The battery may not charge when:
 - you use a USB hub
 - other USB devices are connected to your computer
 - you connect the cable to the port on the front side of your computer
 - the USB port of your computer does not support the power output standard (5 V, 500 mA)

Handle and dispose of batteries and chargers with care

- Never dispose of batteries in a fire. Follow all local regulations when you dispose of used batteries.
- Never place batteries or cameras on or in heating devices, such as microwave ovens, stoves, or radiators. Batteries may explode when they are overheated.



Personal injury or death can occur if the battery is handled carelessly or improperly. For your safety, follow these instructions for proper battery handling:

- The battery can ignite or explode if not handled properly. If you notice any deformities, cracks, or other abnormalities in the battery, immediately discontinue use of the battery and contact a service center.
- Use only authentic, manufacturer-recommended battery chargers and adapters and charge the battery only by the methods described in this user manual.
- Do not place the battery near heating devices or expose it to excessively warm environments, such as the inside of an enclosed car in the summertime.
- Do not place the battery in a microwave oven.
- Avoid storing or using the battery in hot, humid places, such as spas or shower enclosures.
- Do not rest the device on flammable surfaces, such as bedding, carpets, or electric blankets for a prolonged period.
- When the device is switched on, do not leave it in any confined space for a prolonged period.
- Do not allow battery terminals to come in contact with metallic objects, such as necklaces, coins, keys, or watches.
- Use only authentic, manufacturer-recommended, Lithium-ion replacement batteries.

- Do not disassemble the battery or puncture it with any sharp object.
- Avoid exposing the battery to high pressure or crushing forces.
- Avoid exposing the battery to major impacts, such as dropping it from high places.
- Do not expose the battery to temperatures of 60 °C (140 °F) or above.
- Do not allow the battery to come in contact with moisture or liquids.
- Do not expose the battery to sources of excessive heat such as direct sunshine, fire or the like.

Disposal guidelines

- Dispose of the battery with care.
- Do not dispose of the battery in a fire.
- Disposal regulations may differ by country or region. Dispose of the battery in accordance with all local and federal regulations.

Guidelines for charging the battery

Charge the battery only by the method described in this user manual. The battery can ignite or explode if not charged properly.

Before contacting a service center

If you are having trouble with your camera, try these troubleshooting procedures before you contact a service center. If you have attempted the suggested remedy and are still having problems with your device, contact your local dealer or service center.

 When you leave your camera at a service center, be sure to also leave the other components that may have contributed to the malfunction, such as the memory card and battery.

Situation	Suggested remedies
Cannot turn on the camera	<ul style="list-style-type: none">• Ensure that the battery is inserted.• Ensure that the battery is inserted correctly. (p. 16)• Charge the battery.
The power turns off suddenly	<ul style="list-style-type: none">• Charge the battery.• Your camera may be in Power save mode. (p. 112)• The camera may turn off to prevent the memory card from being damaged due to an impact. Turn on your camera again.
The camera is losing battery power quickly	<ul style="list-style-type: none">• The battery may lose power more quickly in low temperatures (below 0 °C/32 °F). Keep the battery warm by putting it into your pocket.• Using the flash or recording videos depletes the battery quickly. Recharge if needed.• Batteries are consumable parts that must be replaced over time. Get a new battery if the battery life is diminishing quickly.

Situation	Suggested remedies
Cannot capture photos	<ul style="list-style-type: none">• There is no space on the memory card. Delete unnecessary files or insert a new card.• Format the memory card.• The memory card is defective. Get a new memory card.• Make sure that the camera is switched on.• Charge the battery.• Make sure that the battery is inserted correctly.
The camera freezes	Remove the battery and insert it again.
The camera heats up	While you use the camera, it may heat up. This is normal and should not affect your camera's lifespan or performance.
The flash does not work	<ul style="list-style-type: none">• The flash option may be set to off. (p. 55)• You cannot use the flash in some modes.

Situation	Suggested remedies
The flash fires unexpectedly	The flash may fire due to static electricity. The camera is not malfunctioning.
The date and time are incorrect	Set the date and time in the display settings. (p. 111)
The touch screen or buttons do not work	Remove the battery and insert it again.
The camera screen responds poorly	If you use your camera at very low temperatures, it may cause the camera screen to malfunction or discolor. For better performance of your camera screen, use your camera in moderate temperatures.
The memory card has an error	<ul style="list-style-type: none"> • Turn off your camera and then turn it on again. • Remove your memory card and insert it again. • Format your memory card. See "Cautions when using memory cards" for more detail. (p. 119)
Cannot play back files	If you change the name of a file, your camera may not play the file (the name of the file should meet the DCF standard). If you encounter this situation, play back the files on your computer.

Situation	Suggested remedies
The photo is blurry	<ul style="list-style-type: none"> • Make sure that the focus option you set is suitable for close-up shots. (p. 58) • Make sure that the lens is clean. If not, clean the lens. (p. 116) • Make sure that the subject is within range of the flash. (p. 127)
The colors in the photo do not match the actual scene	An incorrect White Balance can create unrealistic color. Select the proper White Balance option to suit the light source. (p. 69)
The photo is too bright	Your photo is overexposed. <ul style="list-style-type: none"> • Turn off the flash. (p. 55) • Adjust the ISO sensitivity. (p. 57) • Adjust the exposure value. (p. 67)
The photo is too dark	Your photo is underexposed. <ul style="list-style-type: none"> • Turn on the flash. (p. 55) • Adjust the ISO sensitivity. (p. 57) • Adjust the exposure value. (p. 67)

Situation	Suggested remedies
The TV does not display your photos	<ul style="list-style-type: none"> • Make sure that the camera is correctly connected to the TV with the A/V cable. • Make sure that your memory card contains photos.
Your computer does not recognize your camera	<ul style="list-style-type: none"> • Make sure that the USB cable is connected correctly. • Make sure that your camera is switched on. • Make sure that you are using a supported operating system.
Your computer disconnects the camera while transferring files	The file transmission may be interrupted by static electricity. Disconnect the USB cable and connect it again.
Your computer cannot play videos	Videos may not play on some video player programs. To play video files captured with your camera, install and use the Intelli-studio program on your computer. (p. 100)

Situation	Suggested remedies
Intelli-studio is not functioning properly	<ul style="list-style-type: none"> • End Intelli-studio and restart the program. • You cannot use Intelli-studio on Macintosh computers. • Make sure that PC Software is turned on in the settings menu. (p. 111) • Depending on your computer's specifications and environment, the program may not launch automatically. If this occurs, click Start → My Computer → Intelli-studio → iStudio.exe on your computer.

Camera specifications

Image sensor	
Type	1/2.3" (Approximately 7.76 mm) CCD
Effective pixels	Approximately 16.2 mega-pixels
Total pixels	Approximately 16.4 mega-pixels
Lens	
Focal length	Samsung Lens f = 4.7 mm-23.5 mm (35 mm film equivalent: 26 mm-130 mm)
F-stop range	F3.3 (W)-F5.9 (T)
Digital zoom	<ul style="list-style-type: none">Still image mode: 1.0X-5.0X (Optical zoom x Digital zoom: 25.0X)Playback mode: 1.0X-14.4X
Display	
Type	TFT LCD
Feature	3.0" (7.6 cm) Wide 230 K Full Touch Screen Panel

Focusing			
Type	TTL auto focus (Multi AF, Center AF, Smart Face Recognition AF, Face Detection AF, Smart Touch AF, One Touch Shooting AF)		
Range		Wide (W)	Tele (T)
	Normal (AF)	80 cm-infinity	1.5 m-infinity
	Macro	5 cm-80 cm	1 m-1.5 m
	Auto Macro	5 cm-infinity	1 m-infinity
Shutter speed			
<ul style="list-style-type: none">Smart Auto: 1/8-1/2,000 sec.Program: 1-1/2,000 sec.Night Shot: 8-1/2,000 sec.			
Exposure			
Control	Program AE		
Metering	Multi, Spot, Center-weighted, Face Detection		
Compensation	±2EV (1/3 EV Step)		
ISO equivalent	Auto, ISO 80, ISO 100, ISO 200, ISO 400, ISO 800, ISO 1600, ISO 3200		

Flash	
Mode	Auto, Red-eye, Fill in, Slow Sync, Off, Red-eye Fix
Range	<ul style="list-style-type: none"> Wide: 0.2 m-3.0 m (ISO Auto) Tele: 1.0 m-1.8 m (ISO Auto)
Recharging time	Approximately 4 sec.
Shake reduction	
DUAL IS [Optical Image Stabilization (OIS) + Digital Image Stabilization (DIS)]	
Effect	
Photo Shooting mode	<ul style="list-style-type: none"> Photo Filter (Smart Filter): Normal, Miniature, Vignetting, Soft Focus, Old Film 1, Old Film 2, Half Tone Dot, Sketch, Fish-eye, Defog, Classic, Retro, Negative, (Custom RGB) Image Adjust: Sharpness, Contrast, Saturation
Video Shooting mode	<ul style="list-style-type: none"> Palette Effect: Palette Effect 1, Palette Effect 2, Palette Effect 3, Palette Effect 4 Movie Filter (Smart Filter): Normal, Miniature, Vignetting, Half Tone Dot, Sketch, Fish-eye, Defog, Classic, Retro, Negative, (Custom RGB)

White Balance

Auto WB, Daylight, Cloudy, Fluorescent_H, Fluorescent_L, Tungsten, Custom Set

Date Imprinting

Date & Time, Date, Off

Shooting

Photos	<ul style="list-style-type: none"> Modes: Smart Auto*, Program, Scene*, Simple Shot, Magic Frame shot, Beauty Shot, Object Highlight, Night Shot, Close Up, Vignetting, Photo Filter, DUAL IS * Smart Auto: Macro, Macro text, Portrait, White, Landscape, Action, Tripod, Night, Night Portrait, Backlight, Backlight Portrait, Blue Sky, Sunset, Macro Color, Natural Green, Fireworks * Scene: Landscape, Text, Sunset, Dawn, Backlight, Beach & Snow Drive: Single, Continuous, Motion Capture, AEB Timer: 2 Sec, 10 Sec, Double
--------	---

Videos	<ul style="list-style-type: none"> Modes: Movie, Smart Movie*, Vignetting, Movie Filter, Palette Effect * Smart Movie: Landscape, Blue Sky, Natural Green, Sunset Format: MP4 (H.264) (Maximum recording time: 20 min) Size: 1280 X 720 HQ, 1280 X 720, 640 X 480, 320 X 240 Frame rate: 30 FPS, 15 FPS Voice: Mute, Sound Alive On, Sound Alive Off OIS: On, Off Video editing (embedded): Pause during recording, Still image capture, Time trimming
Playback	
Type	<p>Single image, Thumbnails, Multi-slide show with music and effect, Movie clip, Smart Album*, 3D Album, Magazine</p> <p>* Smart Album category: Type, Date, Face</p>
Edit	<p>Resize, Rotate, Image Adjust, Trim, Smart Crop, Smart Filter</p>
Effect	<ul style="list-style-type: none"> Image Adjust: Face Retouch, Brightness, Saturation, Contrast, Red-eye Fix, ACB Smart Filter: Normal, Miniature, Vignetting, Soft Focus, Old Film 1, Old Film 2, Half Tone Dot, Sketch, Fish-eye, Defog, Classic, Retro, Negative, Custom RGB

Voice recording

- Voice Recording (Maximum 10 hours)
- Voice Memo in a photo (Maximum 10 sec.)

Storage

Media	<ul style="list-style-type: none"> Internal memory: Approximately 10 MB External memory (Optional): microSD card (up to 2 GB guaranteed), microSDHC card (up to 8 GB guaranteed) <p>Internal memory capacity may not match these specifications.</p>
File format	<ul style="list-style-type: none"> DCF, EXIF 2.21, DPOF 1.1, PictBridge 1.0 Still Image: JPEG (DCF) Movie Clip: MP4 (Video: MPEG-4.AVC/H.264, Audio: AAC) Audio file: WAV

Image size	For 1 GB microSD: Number of photos				
			Super Fine	Fine	Normal
	16m	4608 X 3456	105	206	303
	12m	4608 X 3072	117	230	337
	9m	4608 X 2592	140	275	406
	10m	3648 X 2736	166	323	469
	5m	2592 X 1944	319	607	858
	3m	1984 X 1488	522	954	1,336
	2m	1920 X 1080	742	1,336	1,878
	1m	1024 X 768	1,582	2,505	3,006

These figures are measured under Samsung's standard conditions. Your results may vary depending on the shooting conditions and camera settings.

Interface	
Digital output connector	USB 2.0
Audio input/output	Internal speaker (Mono), Microphone (Mono)
Video output	<ul style="list-style-type: none"> A/V: NTSC, PAL (selectable) HDMI 1.4: NTSC, PAL (selectable)
DC power input connector	20 pin, 4.2 V

Power source

Rechargeable battery	Lithium-ion battery (BP70A, 740 mAh: Min 700 mAh)
----------------------	---

The power source may differ depending on your region.

Dimensions (W X H X D)

102.3 X 56.5 X 19.3 mm (without protrusions)

Weight

126.5 g / 4.46 oz (without battery and memory card)

Operating Temperature

0-40 °C / 32-104° F

Operating Humidity

5-85 %

Software

Intelli-studio

Specifications may change without notice to improve performance.

Glossary

ACB (Auto Contrast Balance)

This feature automatically improves the contrast of your images when the subject is backlit or when there is a high contrast between your subject and the background.

AEB (Auto Exposure Bracket)

This feature automatically captures several images at different exposures to help you capture a properly-exposed image.

AF (Auto Focus)

A system that automatically focuses the camera lens on the subject. Your camera uses the contrast to focus automatically.

Aperture

The aperture controls the amount of light that reaches the camera's sensor.

Camera shake (Blur)

If the camera is moved while the shutter is open, the entire image may appear blurred. This occurs more often when the shutter speed is slow. Prevent camera shake by raising the sensitivity, using the flash, or using a faster shutter speed. Alternately, use a tripod, the DIS or OIS function to stabilize the camera.

Composition

Composition in photography means arranging objects in a photo. Usually, abiding by the rule of thirds leads to a good composition.

DCF (Design rule for Camera File system)

A specification to define a file format and file system for digital cameras created by the Japan Electronics and Information Technology Industries Association (JEITA).

Depth of field

The distance between the nearest and farthest points that can be acceptably focused in a photograph. Depth of field varies with lens aperture, focal length, and distance from the camera to the subject. Selecting a smaller aperture, for example, will increase the depth of field and blur the background of a composition.

Digital zoom

A feature that artificially increases the amount of zoom available with a zoom lens (Optical zoom). When using the Digital zoom, the image quality will deteriorate as the magnification increases.

DPOF (Digital Print Order Format)

A format for writing printing information, such as selected images and number of prints, on a memory card. DPOF-compatible printers, sometimes available at photo shops, can read the information from the card for convenient printing.

EV (Exposure Value)

All the combinations of the camera's shutter speed and lens aperture that result in the same exposure.

EV Compensation

This feature allows you to quickly adjust the exposure value measured by the camera, in limited increments, to improve the exposure of your photos. Set the EV compensation to -1.0 EV to adjust the value one step darker and 1.0 EV to one step brighter.

Exif (Exchangeable Image File Format)

A specification to define an image file format for digital cameras created by the Japan Electronic Industries Development Association (JEIDA).

Exposure

The amount of light allowed to reach the camera's sensor. Exposure is controlled by a combination of the shutter speed, the aperture value, and ISO sensitivity.

Flash

A speed light that helps to create adequate exposure in low-light conditions.

Focal length

The distance from the middle of the lens to its focal point (in millimeters). Longer focal lengths result in narrower angles of view and the subject is magnified. Shorter focal lengths result in wider angles of view.

Histogram

A graphical representation of the brightness of an image. The horizontal axis represents the brightness and the vertical axis represents the number of pixels. High points at the left (too dark) and right (too bright) on the histogram indicate a photo that is improperly exposed.

H.264/MPEG-4

A high-compression video format established by international standard organizations ISO-IEC and ITU-T. This codec is capable of providing good video quality at low bit rates developed by the Joint Video Team (JVT).

Image sensor

The physical part of a digital camera that contains a photosite for each pixel in the image. Each photosite records the brightness of the light that strikes it during an exposure. Common sensor types are CCD (Charge-coupled Device) and CMOS (Complementary Metal Oxide Semiconductor).

ISO sensitivity

The sensitivity of the camera to light, based on the equivalent film speed used in a film camera. At higher ISO sensitivity settings, the camera uses a higher shutter speed, which can reduce blur caused by camera shake and low light. However, images with high sensitivity are more susceptible to noise.

JPEG (Joint Photographic Experts Group)

A lossy method of compression for digital images. JPEG images are compressed to reduce their overall file size with minimal deterioration of the image resolution.

LCD (Liquid Crystal Display)

A visual display commonly used in consumer electronics. This display needs a separate backlight, such as CCFL or LED, to reproduce colors.

Macro

This feature allows you to capture close-up photos of very small objects. When using the macro feature, the camera can maintain a sharp focus on small objects at a near life-size ratio (1:1).

Metering

The metering refers to the way in which the camera measures the quantity of light to set the exposure.

MJPEG (Motion JPEG)

A video format which is compressed as a JPEG image.

Noise

Misinterpreted pixels in a digital image that may appear as misplaced or random, bright pixels. Noise usually occurs when photos are shot with a high sensitivity or when a sensitivity is automatically set in a dark place.

Optical zoom

This is a general zoom which can enlarge images with a lens and does not deteriorate quality of images.

Quality

An expression of the rate of compression used in a digital image. Higher quality images have a lower rate of compression, which usually results in a larger file size.

Resolution

The number of pixels present in a digital image. High resolution images contain more pixels and typically show more detail than low resolution images.

Shutter speed

Shutter speed refers to the amount of time it takes to open and close the shutter, and it is an important factor in the brightness of a photo, as it controls the amount of light which passes through the aperture before it reaches the image sensor. A fast shutter speed allows less time to let light in and the photo becomes darker and more easily freezes subjects in motion.

Vignetting

A reduction of an image's brightness or saturation at the periphery (outer edges) compared to the center of the image. Vignetting can draw interest to subjects positioned in the center of an image.

White balance (color balance)

An adjustment of the intensities of colors (typically the primary colors red, green, and blue), in an image. The goal of adjusting the white balance, or color balance, is to correctly render the colors in an image.



Correct Disposal of This Product (Waste Electrical & Electronic Equipment)

(Applicable in the European Union and other European countries with separate collection systems)

This marking on the product, accessories or literature indicates that the product and its electronic accessories (e.g. charger, headset, USB cable) should not be disposed of with other household waste at the end of their working life. To prevent possible harm to the environment or human health from uncontrolled waste disposal, please separate these items from other types of waste and recycle them responsibly to promote the sustainable reuse of material resources. Household users should contact either the retailer where they purchased this product, or their local government office, for details of where and how they can take these items for environmentally safe recycling. Business users should contact their supplier and check the terms and conditions of the purchase contract. This product and its electronic accessories should not be mixed with other commercial wastes for disposal.



PlanetFirst represents Samsung Electronics' commitment to sustainable development and social responsibility through eco-driven business and management activities.



Correct disposal of batteries in this product

(Applicable in the European Union and other European countries with separate battery return systems)

This marking on the battery, manual or packaging indicates that the batteries in this product should not be disposed of with other household waste at the end of their working life. Where marked, the chemical symbols Hg, Cd or Pb indicate that the battery contains mercury, cadmium or lead above the reference levels in EC Directive 2006/66. If batteries are not properly disposed of, these substances can cause harm to human health or the environment.

To protect natural resources and to promote material reuse, please separate batteries from other types of waste and recycle them through your local, free battery return system.

This Class [B] digital apparatus complies with Canadian ICES-003.

FCC notice

- **NOTE:**

This equipment has been tested and found to comply with the limits for a Class B digital device, pursuant to part 15 of the FCC Rules. These limits are designed to provide reasonable protection against harmful interference in a residential installation. This equipment generates, uses and can radiate radio frequency energy and, if not installed and used in accordance with the instructions, may cause harmful interference to radio communications. However, there is no guarantee that interference will not occur in a particular installation. If this equipment does cause harmful interference to radio or television reception, which can be determined by turning the equipment off and on, the user is encouraged to try to correct the interference by one or more of the following measures:

- Reorientate, or relocate, the receiving antenna.
- Increase the distance between the equipment and receiver.
- Connect the equipment into an outlet on a circuit different from that to which the receiver is connected.
- Consult the dealer or an experienced radio / TV technician for help.

- **CAUTION:**

Changes or modifications not expressly approved by the manufacturer responsible for compliance could void the user's authority to operate the equipment.

- **Declaration of Conformity**

Trade Name	: Samsung Electronics America, Inc.
Model No.	: Samsung ST6500
Responsible Party	: Samsung Electronics America, Inc.
Address	: 85 Challenger Road, Ridgefield Park, NJ 07660
Telephone No.	: 1-800-SAMSUNG (726-7864)

This device complies with Part 15 of the FCC Rules. Operation is subject to the following two conditions:
(1) This device may not cause harmful interference, and (2) this device must accept any interference received, including interference that may cause undesired operation.

Index

A

- AF-assist light
 - location 14
 - settings 113
- AF Lamp 113
- AF Sound 109
- Anynet+ 110
- Aperture value 37
- Auto Contrast Balance (ACB)
 - Playback mode 95
 - Shooting mode 67
- Auto Exposure Bracket (AEB) 71
- A/V port 14

B

- Battery
 - caution 121
 - charging 17
 - inserting 16
- Beauty Shot mode 37
- Blink detection 64
- Brightness
 - Playback mode 94
 - Shooting mode 67
- Burst modes
 - Auto Exposure Bracket 71
 - Continuous 71
 - Motion Capture 71

C

- Camera maintenance 116
- Camera specifications 127
- Charging 17
- Cleaning
 - camera body 116
 - lens 116
 - touch screen 116
- Close up shot
 - Close up mode 36
 - macro 58
- Connecting to a computer
 - Mac 104
 - Windows 99
- Contrast
 - Playback mode 94
 - Shooting mode 75

D

- Date/Time set 111
- Deleting files 86
- Digital Print Order Format (DPOF) 96
- Digital zoom 27
- Disconnecting the camera 103
- Display brightness 110
- Display set 23
- DUAL IS mode 35

E

- Editing photos 92
- Editing videos
 - capturing 90
 - trimming 90
- Enlarging 87
- Error messages 115

F

Face detection 62

Flash

- Auto 55
- Fill in 56
- Off 55
- Red-eye 56
- Red-eye fix 56
- Slow sync 56

Focus area

- Center AF 61
- Multi AF 61
- One touch shooting 61
- Smart Touch AF 61

Focus sound 109

Formatting 113

G

Guide lines 109

H

Half-press shutter 30

HDMI Output 111

HDTV 98

Home button 15

Home screen 24

I**Icons**

- Home screen 24
- Playback mode 82
- Shooting mode 20

Image adjustment

- brightness
 - Playback mode 94
 - Shooting mode 67
- contrast
 - Playback mode 94
 - Shooting mode 75
- red-eye 96
- saturation
 - Playback mode 94
 - Shooting mode 75
- sharpness 75

Image quality 52

Imprint 112

Intelli-studio 101

Intelli zoom 28

ISO sensitivity 57

L

Language settings 111

Learning icons 20

M

Macro 58

Magic Frame Shot mode 43

Memory card

- caution 119
- Insert 16

Metering

- Center-weighted 69
- Multi 69
- Spot 69

Motion capture 71

Motion recognition 81

Movie Filter mode 45

My star

- ranking 82
- registering 65

N

Night Shot mode 37

O

Object Highlight mode 42

One touch shooting 60

Optical Image Stabilization (OIS) 29

Optional accessories 13

P

Palette Effect mode 47
Photo Filter mode 43
PictBridge 105
Playback button 15
Playback mode 80
Power button 14
Power save mode 110
Printing photos 105
Program mode 38
Protecting files 86

Q

Quick view 110

R

Red-eye
Playback mode 96
Shooting mode 55
Reset 113
Resolution
Playback mode 92
Shooting mode 51
Retouching faces
Playback mode 95
Shooting mode 37
Rotating 93

S

Saturation
Playback mode 94
Shooting mode 75
Scene mode 36
Self portrait shot 63
Service center 124
Settings 108

Sharpness 75

Shooting portraits

Beauty Shot mode 37
Blink detection 64
Face detection 62
Red-eye 56
Red-eye fix 56
Self portrait 63
Smart Face Recognition 64
Smile shot 63

Shutter button 14

Simple Shot mode 34

Slide show 88

Smart Album 83

Smart Auto mode 33

Smart Crop 93

Smart Face Recognition 64

Smart Filter

Playback mode 94
Shooting mode 72

Smart Movie mode 40

Smile shot 63

Sound settings 23

Start image 92, 109

Status lamp 15

T

Thumbnails 83

Timer

timer lamp 14
Using the timer 54

Time settings 18, 111

Time zone settings 18, 111

Touch calibration 19, 113

Touch screen 15

Transferring files

Mac 104
Windows 99

Tripod mount 14

U

Unpacking 13

USB port 14

User buttons 38

Using the touch screen

flicking 21

scrolling 21

touching 21

V

Video

playing 89

shooting 39

Viewing files

page flip effect 84

slide show 88

Smart Album 83

thumbnails 85

TV 97

Vignetting mode 46

Voice memo

playing 91

recording 48

W

White Balance 69

Z

Zoom

using the zoom 27

zoom button 15

zoom sound settings 76



Please refer to the warranty that came with your product or visit our website <http://www.samsung.com/> for after-sales service or inquiries.

