

ENGLISH



Canon DIGITAL CAMERA *PowerShot A720 IS* Camera User Guide

Canon

PowerShot A720 IS

Camera User Guide



Getting Started

Learning More

Components Guide

Basic Operations

Commonly Used Shooting Functions

Shooting Using the Mode Dial

Various Shooting Methods

Playback/Erasing

Print Settings/Transfer Settings

Connecting to a TV

Troubleshooting

List of Messages

Appendix

Ensure that you read the Safety Precautions (pp. 162–167).

Workflow and Reference Guides

The following guides are available. Refer to them as necessary according to the flowchart below.

 : Contents of This Guide

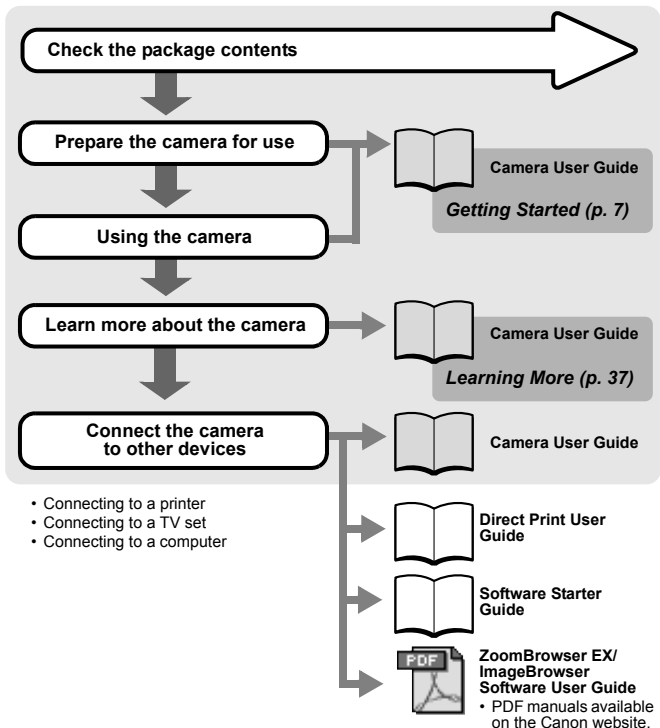

<http://web.canon.jp/Imaging/information-e.html>

Checking the Package Contents

The following items are included in the package. If something is missing, please contact the retail outlet at which you purchased the product.

1



Camera

2



AA Alkaline Batteries (x2)

3



Memory Card
(16MB)

4

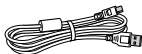

Interface Cable
IFC-400PCU

5



AV Cable
AVC-DC300

6



Wrist Strap
WS-200

7



Canon Digital Camera
Solution Disk

8



Warranty Card

9

User Guides



- Camera User Guide
- Direct Print User Guide
- Software Starter Guide
- "Canon Customer Support" Leaflet

You may not be able to achieve the full performance of this camera with the included memory card.





You can use SD memory cards, SDHC (SD High Capacity) memory cards, MultiMediaCards, MMCplus cards and HC MMCplus cards in this camera. These cards are collectively referred to as memory cards in this guide.

Table of Contents

Items marked with a ☆ are lists or charts that summarize camera functions or procedures.



Please Read





6

Getting Started	7
Preparations	8
Shooting Still Images ( Auto Mode)	14
Viewing Still Images	17
Shooting Movies ( Standard Mode)	18
Viewing Movies	20
Erasing	21
Printing	22
Downloading Images to a Computer	24
System Map	32

Learning More

37

Components Guide	38
Indicators	41
Power Saving Function	41
Basic Operations	42
☆ Menus and Settings	42
☆ Menus and Default Settings	44
Using the LCD Monitor	49
Information Displayed on the LCD Monitor	50
Resetting Settings to Their Default Values	55
Formatting Memory Cards	56
Commonly Used Shooting Functions	57
Changing the Recording Pixels/ Compression (Still Images) 57	
  Shooting with the Optical Zoom	59
Using the Digital Zoom/Digital Tele-Converter	60
⚡ Using the Flash	64

 Shooting Close-ups (Macro)	65
Using the Self-Timer	66
Setting the Image Stabilizer Function	68
Configuring the Postcard Mode	70
Embedding the Date in the Image Data.	71
Shooting Using the Mode Dial	73
<hr/>	
Mode Dial.	73
Shooting Modes for Specific Scenes	74
 Shooting Panoramic Images (Stitch Assist)	77
 Movie Shooting	79
P Program AE	82
Tv Setting the Shutter Speed.	83
Av Setting the Aperture	85
M Manually Setting the Shutter Speed and Aperture.	86
Various Shooting Methods	87
<hr/>	
Continuous Shooting	87
Setting the Red-Eye Reduction Function.	88
Setting the Slow Synchro Function	89
Selecting an AF Frame Mode	90
Shooting Hard-to-Focus Subjects (Focus Lock, AF Lock, Manual Focus, Safety MF).	94
Locking the Exposure Setting (AE Lock).	98
Locking the Flash Exposure Setting (FE Lock)	99
Adjusting the ISO Speed	100
 Adjusting the Exposure Compensation	101
Switching between Metering Modes	102
Adjusting the Tone (White Balance)	104
Shooting in a My Colors Mode.	107
Switching between Flash Adjustment Settings	109
Adjusting Flash Compensation Settings	110
Setting the Flash Output	111
Switching the Timing at which the Flash Fires.	112
Adjusting Exposure for Built-in Flash Shooting (Safety FE)	113
 Registering Settings to the Print/Share Button	114
Setting the Auto Rotate Function.	115
Setting the Display Overlays	117

Creating an Image Destination (Folder)	118
Resetting the File Number	120
Playback/Erasing	122
🔍 Magnifying Images	122
🖼️ Viewing Images in Sets of Nine (Index Playback)	123
🏠 Jumping to Images	124
Viewing Movies (Operating the Movie Control Panel)	125
Rotating Images in the Display	127
Playback with Transition Effects	128
Automated Playback (Auto Play)	129
Red-Eye Correction Function	130
Resizing Images	134
Attaching Sound Memos to Images	136
Protecting Images	137
Erasing All Images	138
Print Settings/Transfer Settings	139
Setting the DPOF Print Settings	139
Setting the DPOF Transfer Settings	144
Connecting to a TV	146
Shooting/Playback Using a TV	146
Troubleshooting	147
List of Messages	158
Appendix	162
Safety Precautions	162
Preventing Malfunctions	167
Battery Handling	168
Handling the Memory Card	170
Using the Power Kits (Sold Separately)	172
Using the Lenses (Sold Separately)	175
Using an Externally Mounted Flash (Sold Separately)	180
Replacing the Date Battery	182
Camera Care and Maintenance	184
Specifications	185

Symbol Conventions in this Guide

64 Commonly Used Shooting Functions

Using the Flash

See Functions Available in Each Shooting Mode (p. 212)

Shooting Mode:

1 Press the **↓** button.

1. Use the **↑** or **↓** button to change the flash mode.

- : [Auto]
- : [On]
- : [Off]

You are recommended to shoot with the camera attached to a tripod or other device if the camera shake warning icon appears.

When the LCD monitor is on and flash recharging begins, the indicator blinks orange and the LCD monitor turns off. When recharging ends, the indicator turns off and the LCD monitor turns on. The time required for flash recharging will change depending on usage conditions and remaining battery power.

Mode switch position:
Rec. () / Play ()

Available shooting modes

P Tv Av

These modes are not available

These modes are available

This mark denotes issues that may affect the camera's operation.

This mark denotes additional topics that complement the basic operating procedures.

Explanations in this guide are based on the camera's default settings at time of purchase.

Please Read

Test Shots

Before you try to photograph important subjects, we highly recommend that you shoot several trial images to confirm that the camera is operating and being operated correctly.

Please note that Canon Inc., its subsidiaries and affiliates, and its distributors are not liable for any consequential damages arising from any malfunction of a camera or accessory, including memory cards, that results in the failure of an image to be recorded or to be recorded in a way that is machine readable.

Warning Against Copyright Infringement

Please note that Canon digital cameras are intended for personal use and should never be used in a manner that infringes upon or contravenes international or domestic copyright laws and regulations. Please be advised that in certain cases the copying of images from performances, exhibitions, or commercial properties by means of a camera or other device may contravene copyright or other legal rights even if the image was shot for personal use.

Warranty Limitations

This camera's warranty is only effective in the country of sale. If a problem arises while the camera is in use abroad, please convey it back to the country of sale before proceeding with a warranty claim to a Canon Customer Support Help Desk.

For Canon Customer Support contacts, please see the customer support list supplied with your camera.

Camera Body Temperature

If your camera is used for prolonged periods, the camera body may become warm. Please be aware of this and take care when operating the camera for an extended period.

About the LCD Monitor

The LCD monitor is produced with extremely high-precision manufacturing techniques. More than 99.99% of the pixels operate to specification. Less than 0.01% of the pixels may occasionally misfire or appear as red or black dots. This has no effect on the recorded image and does not constitute a malfunction.

Video Format

Please set the camera's video signal format to the one used in your region before using it with a TV monitor.

Language Setting

Please see *Setting the Display Language* (p. 13) to change the language setting.

Getting Started

- **Preparations**
- **Shooting Still Images**
- **Viewing Still Images**
- **Shooting Movies**
- **Viewing Movies**
- **Erasing**
- **Printing**
- **Downloading Images to a Computer**
- **System Map**

Preparations

■ Attaching the Wrist Strap

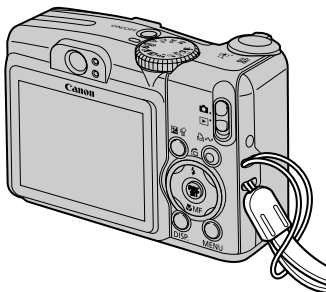

It is recommended to use the Wrist Strap to avoid dropping during camera use.

Installing the batteries

1. Slide the battery cover lock in the direction of the arrow (①) and hold it there while moving the entire cover in the direction of the arrow (②) and opening it up in the direction of the arrow (③).

Battery Cover Lock

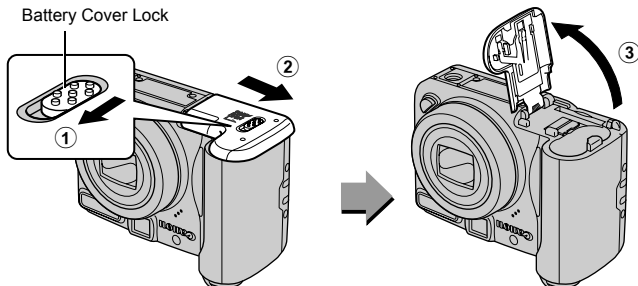

2. Install two batteries.

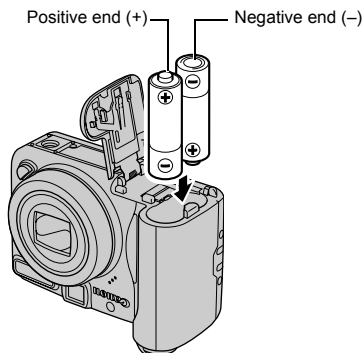

3. Close the cover (①), and press downward as you slide it until it clicks into place (②).

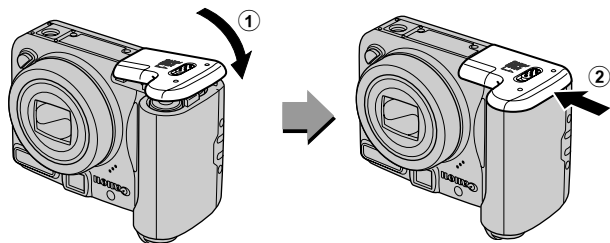

Inserting the Memory Card

- Slide the battery cover lock in the direction of the arrow (1) and hold it there while moving the entire cover in the direction of the arrow (2) and opening it up in the direction of the arrow (3).

Battery Cover Lock

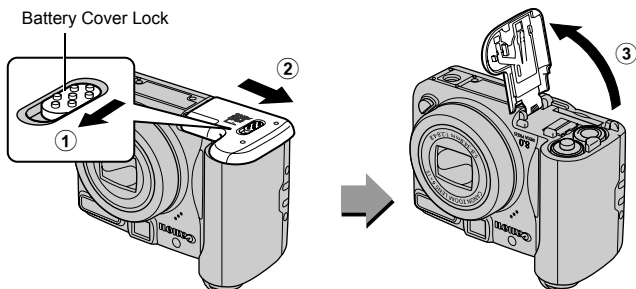

- Insert the memory card until its clicks into place.

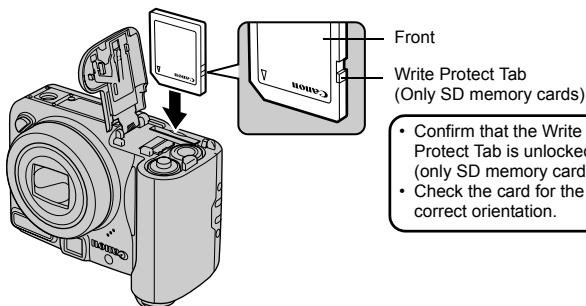

- Confirm that the Write Protect Tab is unlocked (only SD memory cards).
- Check the card for the correct orientation.

- 3. Close the cover (①), and press downward as you slide it until it clicks into place (②).**

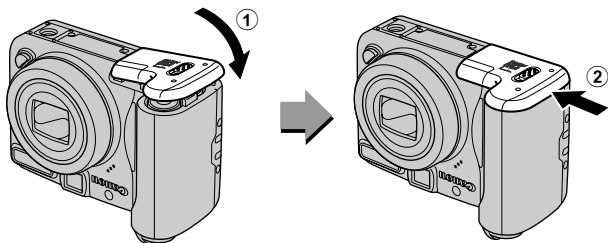

Ensure that the memory card is correctly oriented before inserting it in the camera. Inserting it backward may cause the camera to fail to recognize the memory card or to malfunction.

■ To Remove the Memory Card

- Push the memory card with your finger until the memory card clicks and then release it.

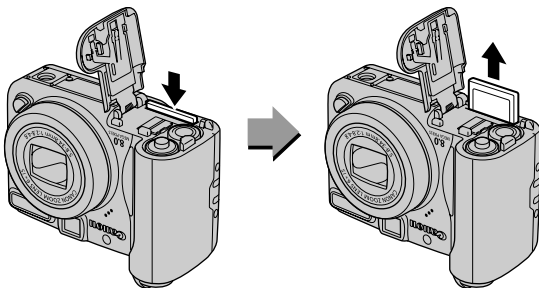





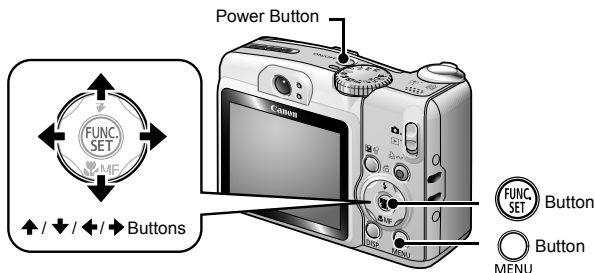

Setting the Date and Time

The Date/Time settings menu will appear the first time the power is turned on. Set the date and time as shown in steps 3 and 4 in the explanation below.





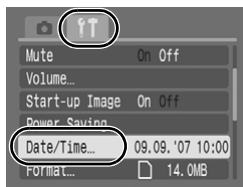

1. Press the power button.

2. Select [Date/Time].

1. Press the  button.
2. Use the  or  button to select the  (Set up) menu.
3. Use the  or  button to select [Date/Time].
4. Press the  button.



3. Select the year, month, day and time, and the display order.

1. Use the  or  button to select a category.
2. Use the  or  button to set the value.

4. Press the  button.

5. Press the  button.





You can imprint the date and time you have set onto images (p. 71).

Setting the Display Language

You can change the language displayed in the LCD monitor menus and messages.

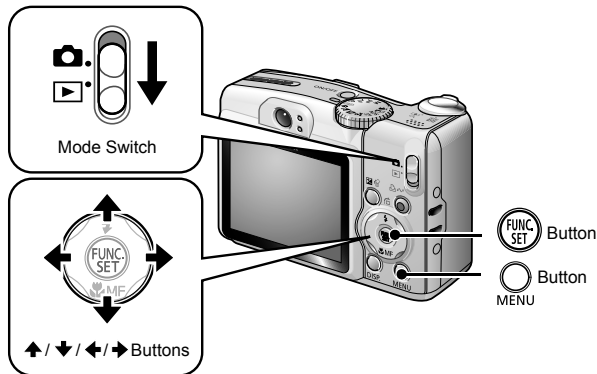

1. Set the mode switch to (Playback).
2. Hold down the button and press the button.
3. Use the , , or button to select a language.
4. Press the button.

Shooting Still Images (**AUTO** Auto Mode)

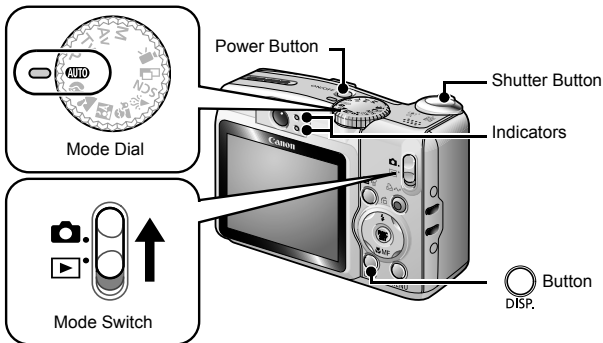

1. Press the power button.

- The start-up sound will play and the start-up image will display in the LCD monitor.
- Pressing the power button again turns the power off.

2. Select a shooting mode.

1. Set the mode switch to  (Shooting).
2. Set the mode dial to **AUTO** (Auto).



3. Aim the camera at the subject.

4. Press the shutter button lightly (press halfway) to set the focus.

- When the camera focuses, it beeps twice and the indicator lights green (orange when the flash fires).

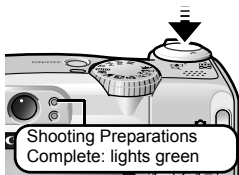

- AF frames will display in green on the LCD monitor at the points of focus.

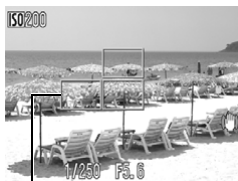

AF frame

5. Without changing anything else, press the shutter button all the way (press fully) to shoot.

- The shutter sound will play once and the image will record.
- The indicator will blink green and the file will record to the memory card.

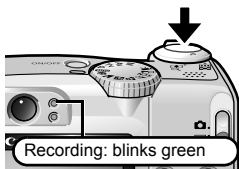

Mute Setting

Pressing the **DISP.** button while switching on the camera power will set the mute setting to [On] to silence all camera sounds except for warning sounds. The setting can be changed with the [Mute] option in the **[i]** (Set up) Menu (p. 46).

Reviewing an Image Right After Shooting (Rec. Review)

Recorded images are displayed on the LCD monitor for approximately 2 seconds immediately after shooting.

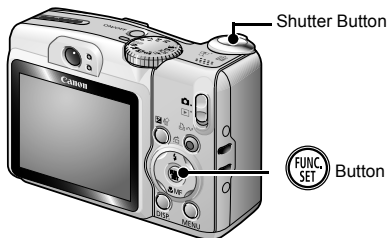

You can also use the following methods to continue displaying the image immediately after shooting so that you can check it.

- **Keep the shutter button pressed fully.**
- **Press the  button while the recorded image is displayed.**

Confirm that the operation sound beeps.

You can shoot by pressing the shutter button even when an image is being displayed.

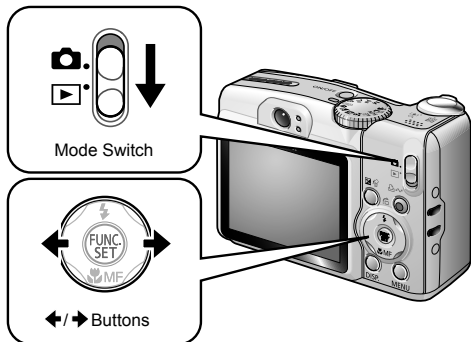

Viewing Still Images



1. Set the mode switch to (Playback).

- The last recorded image will display.

2. Use the or button to display the image you wish to view.



- Use the  button to move to the previous image and the  button to move to the next image.
- The images advance more quickly if you keep the button pressed continuously, but they will appear coarse.

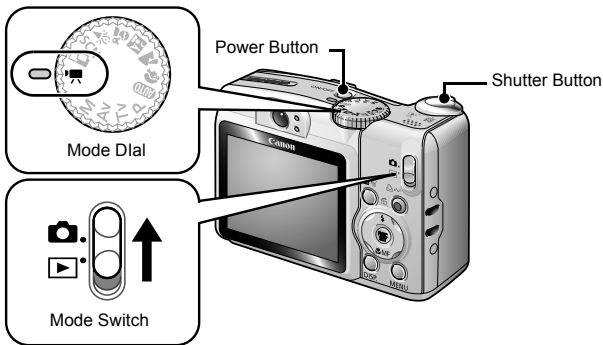

If you have replayed images, the last image viewed will display (Resume Playback). If the memory card has been switched, or the images on the memory card have been edited with a computer, the newest image on the memory card appears.

Shooting Movies (Standard Mode)



- 1. Press the power button.**
- 2. Select a shooting mode.**
 1. Set the mode switch to  (Shooting).
 2. Set the mode dial to  (Movie).
 - Confirm that the camera is set to  (Standard).
- 3. Aim the camera at the subject.**



- Do not touch the microphone while recording.
- Do not press any buttons other than the shutter button. The sound that buttons make will be recorded in the movie.



Microphone

4. Press the shutter button lightly (press halfway) to set the focus.

- An electronic beep will sound twice and the indicator will light green when the camera focuses.
- The exposure, focus and white balance are automatically set when you press the button halfway.

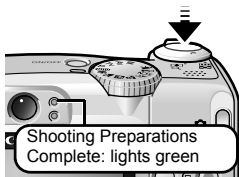

5. Without changing anything else, press the shutter button all the way (press fully) to shoot.

- Recording starts.
- During the recording, the elapsed recording time and [●Rec.] will display in the LCD monitor.

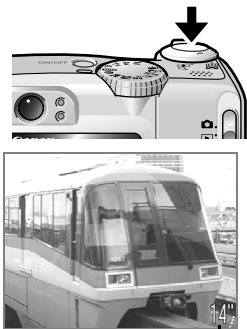

Elapsed time

6. Press the shutter button fully again to stop recording.

- The indicator will blink green and the data will be recorded onto the memory card.
- Recording will stop automatically when the maximum recording time elapses, or the built-in memory or memory card become full.

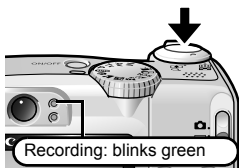

Viewing Movies

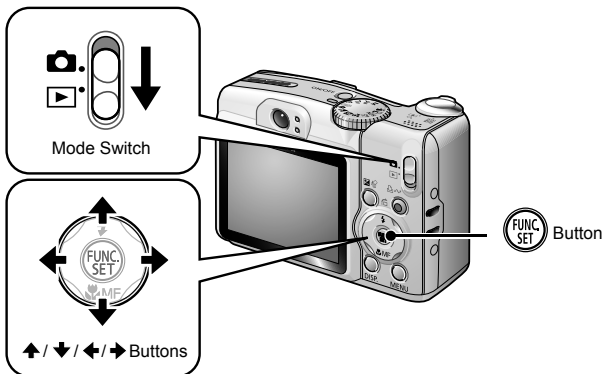

1. Set the mode switch to (Playback).
2. Use the or button to display a movie and press the button.

• Images with a icon are movies.



3. Use the or button to select (Play) and press the button.

- The movie will start playing.
- If you press the **FUNC./SET** button during playback, you can pause and restart the movie.
- You can adjust the playback volume with the or button.



Erasing

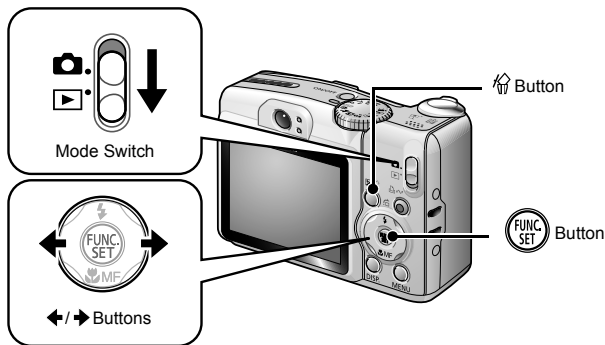

1. Set the mode switch to (Playback).
2. Use the or button to select an image to erase and press the button.
3. Confirm that [Erase] is selected and press the button.
 - To exit instead of erasing, select [Cancel].



Please note that erased images cannot be recovered. Exercise adequate caution before erasing an image.

Printing

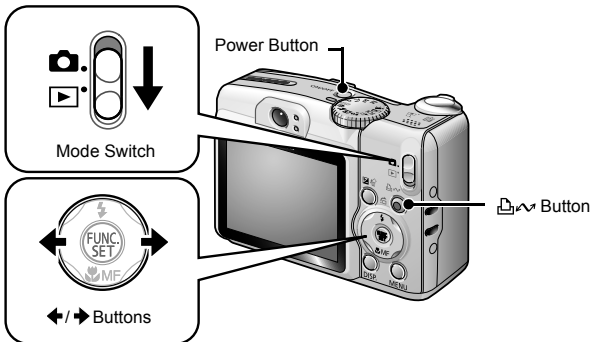

1. Connect the camera to a direct print compatible printer*1.

- Open the Camera's terminal cover and insert the interface cable all the way into the connector.
- See the printer's user guide for connection instructions.

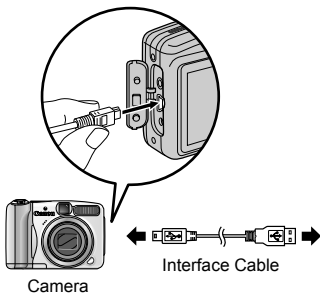

Canon Brand Printers

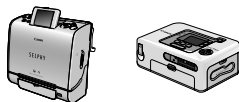

SELPHY Series Compact Photo Printers*2

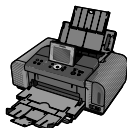









PIXMA Series Bubble Jet Printers

*1 Since this camera uses a standard protocol (PictBridge), you can use it with other PictBridge-compliant printers in addition to Canon-brand printers.

*2 You can also use the CP-10/CP-100/CP-200/CP-300.

2. Turn on the printer.**3. Set the camera's mode switch to  (Playback) and press the power button.**

- The  button will light blue.
- A ,  or  icon will appear in the LCD monitor if the connection is correct (the displayed icons differ according to the connected printer).
-   will display for movies.

**4. Use the  or  button to select an image to print and press the  button.**

- The  button will blink blue and printing will start.

After you finish printing, turn off the camera and the printer and disconnect the interface cable.

Downloading Images to a Computer

Items to Prepare

- Camera and computer
- Canon Digital Camera Solution Disk supplied with the camera
- Interface cable supplied with the camera

System Requirements

Please install the software on a computer meeting the following minimum requirements.

■ Windows

OS	Windows Vista Windows XP Service Pack 2 Windows 2000 Service Pack 4
Computer Model	The above OS should be pre-installed on computers with built-in USB ports.
CPU	Windows Vista Pentium 1.3 GHz or higher Windows XP/Windows 2000 Pentium 500 MHz or higher
RAM	Windows Vista 512 MB or more Windows XP/Windows 2000 256 MB or more
Interface	USB
Free Hard Disk Space	<ul style="list-style-type: none"> • Canon Utilities <ul style="list-style-type: none"> - ZoomBrowser EX 200 MB or more - PhotoStitch 40 MB or more • Canon Camera TWAIN Driver 25 MB or more
Display	1,024 x 768 pixels/High Color (16 bit) or better

■ Macintosh

OS	Mac OS X (v10.3–v10.4)
Computer Model	The above OS should be pre-installed on computers with built-in USB ports.
CPU	PowerPC G3/G4/G5 or Intel Processor
RAM	256 MB or more
Interface	USB
Free Hard Disk Space	<ul style="list-style-type: none"> • Canon Utilities <ul style="list-style-type: none"> - ImageBrowser 300 MB or more - PhotoStitch 50 MB or more
Display	1,024 x 768 pixels/32,000 Colors or better

Preparing to Download Images

Ensure that you install the software first before connecting the camera to the computer.

1. Installing the software.

■ Windows

1. Place the Canon Digital Camera Solution Disk in the computer's CD-ROM drive.

2. Click [Easy Installation].

Follow the onscreen messages to proceed with the installation.

3. Click [Restart] or [Finish] once the installation is complete.

When the installation is complete, [Restart] or [Finish] will display. Click the button that appears.

4. Remove the CD-ROM from the drive when your normal desktop screen appears.

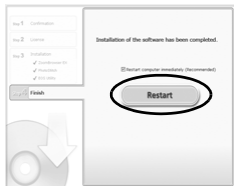

■ Macintosh

Double-click the  icon in the CD-ROM window. When the installer panel appears, click [Install]. Follow the onscreen instructions to proceed.



2. Connecting the camera to a computer.

1. Connect the supplied interface cable to the computer's USB port and to the camera's DIGITAL terminal.

- Open the Camera's terminal cover and insert the interface cable all the way into the connector.

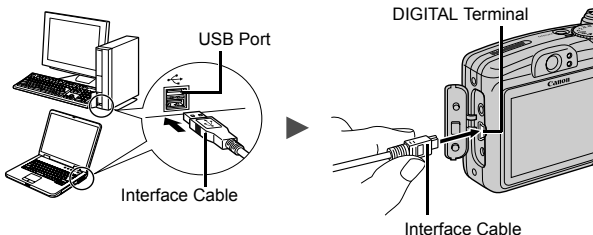

3. Preparing to download images to the computer.

1. Set the camera's mode switch to (Playback) and press the power button.

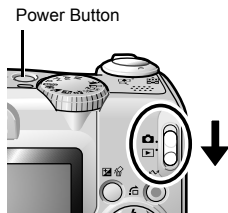

Always grasp the sides of the connector when disconnecting the interface cable from the camera's DIGITAL terminal.



If the Digital Signature Not Found window appears, click [Yes]. The USB driver will automatically finish installing onto the computer when you attach the camera and open a connection.

■ Windows

Select [Canon CameraWindow] and click [OK].



If this Events dialog does not appear, click the [Start] menu and select [All Programs] or [Programs], followed by [Canon Utilities], [CameraWindow], [CameraWindow] and [CameraWindow].

CameraWindow will display.



Preparations for downloading images are now finished. Please proceed to the Downloading Images Using the Camera (Direct Transfer) section (p. 29) (except Windows 2000).



With Windows 2000, you can download images using the computer. Please refer to the *Software Starter Guide* for details.

■ Macintosh

CameraWindow will appear when you establish a connection between the camera and computer. If it fails to appear, click the [CameraWindow] icon on the Dock (the bar which appears at the bottom of the desktop).



Preparations for downloading images are now finished. Please proceed to the Downloading Images Using the Camera (Direct Transfer) section (p. 29).



Please refer to the *Software Starter Guide* regarding how to download images using the computer.

Downloading Images Using the Camera (Direct Transfer)

Install the software before downloading images via the Direct Transfer method for the first time (p. 25).

Use this method to download images using camera operations (except Windows 2000).

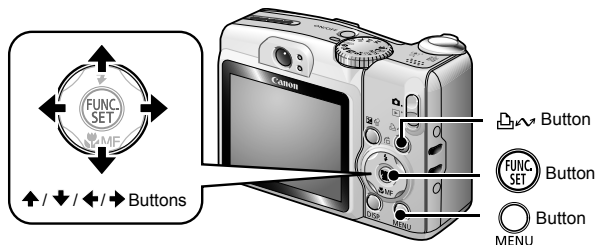

	All Images	Transfers and saves all images to the computer.
	New Images	Transfers and saves to the computer only the images that have not been previously transferred.
	DPOF Trans. Images	Transfers and saves to the computer only the images with DPOF Transfer Order settings.
	Select & Transfer	Transfers and saves single images to the computer as you view and select them.
	Wallpaper	Transfers and saves single images to the computer as you view and select them. The transferred images as the background on the computer desktop.

1. Confirm that the Direct Transfer menu is displayed on the camera's LCD monitor.

- The  button will light blue.
- Press the **MENU** button if the Direct Transfer menu fails to appear.

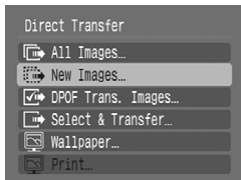

Direct Transfer Menu

■ All Images/New Images/DPOF Trans. Images

2. Use the or button to select , or and press the button.

- The images will download. The  button will blink blue while downloading is in progress.
- The display will return to the Direct Transfer menu when the download is complete.
- To cancel the download, press the **FUNC./SET** button.

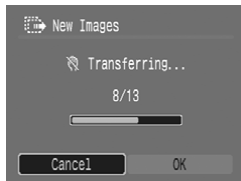

■ Select & Transfer/Wallpaper

2. Use the or button to select or and press the (or) button.

3. Use the or button to select images to download and press the button.

- The images will download. The  button will blink blue while downloading is in progress.
- Pressing the **FUNC./SET** button will cancel a download in progress.



4. Press the button after downloading finishes.

- You will return to the Direct Transfer menu.



Only JPEG images can be downloaded as wallpaper for a computer.



The option selected with the  button is retained even when the camera's power is turned off. The previous setting will be in effect the next time the Direct Transfer menu is displayed. The image selection screen will appear directly when the [Select & Transfer] or the [Wallpaper] option was last selected.

Click  at the bottom right of the window to close the CameraWindow and the downloaded images will display on the computer.

■ Windows

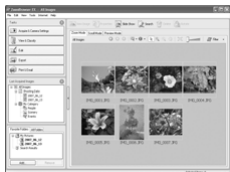

ZoomBrowser EX

■ Macintosh



ImageBrowser

By default, images are saved on the computer in folders according to the shooting date.

System Map

Supplied with Camera



Wrist Strap
WS-200



AA Alkaline
Batteries (x2)



Interface Cable IFC-400PCU*1



Memory Card (16MB)



Canon Digital Camera
Solution Disk

AV Cable AVC-DC300*1



Waterproof Case
WP-DC16



Waterproof Case
Weight WW-DC1

Battery and Charger Kit CBK4-300*5



- Battery Charger CB-5AH/
CB-5AHE
- AA-size NiMH batteries NB-
3AH (x4)
- NiMH Battery NB4-300 (set of 4
AA-size) also available separately

AC Adapter Kit ACK800



- Compact Power Adapter
CA-PS800
- Power Cord

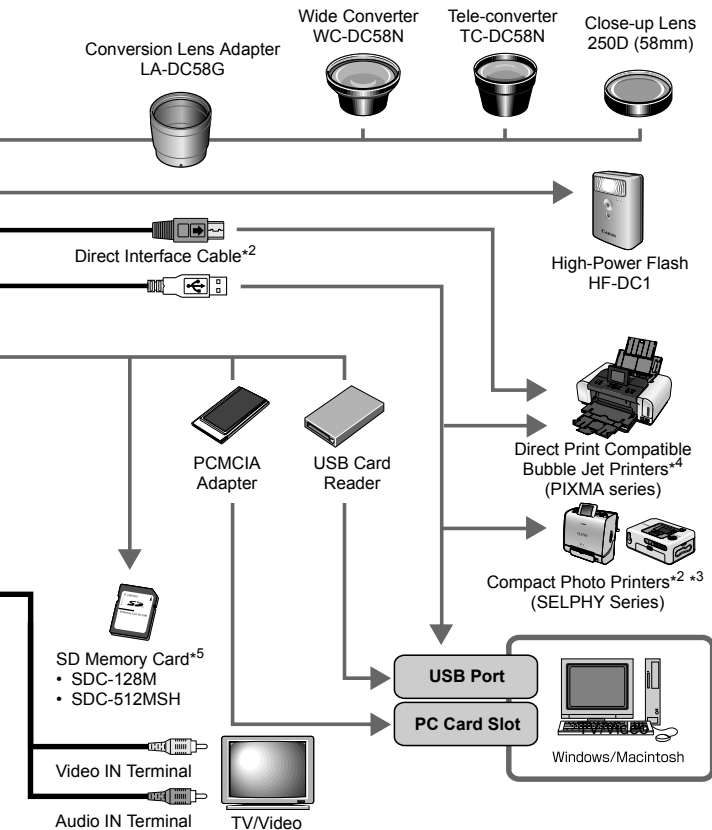

*1 Also available for purchase separately.

*2 See the user guide supplied with the printer for more information on the printer.

*3 This camera can also be connected to the CP-10/CP-100/CP-200/CP-300.

*4 See the user guide supplied with the Bubble Jet printer for more information on the printer and interface cables.

*5 Not sold in some regions.

Optional Accessories

The following camera accessories are sold separately. Some accessories are not sold in some regions, or may no longer be available.

■ Lenses, Lens Adapter

- **Conversion Lens Adapter LA-DC58G**

This adapter is required for mounting the wide converter, tele-converter and close-up lens to the camera.

- **Wide Converter WC-DC58N**

Converts the focal distance of the body lens by a factor of approximately 0.7 when attached.

- **Tele-converter TC-DC58N**

Converts the focal distance of the body lens by a factor of approximately 1.75 when attached.

- **Close-up Lens 250D (58mm)**

A lens for shooting subjects at high magnifications.

■ Flash

- **High-Power Flash HF-DC1**

This attachable supplementary flash can be used to capture photographic subjects that are too distant for the built-in flash to illuminate.

■ Power Supplies

- **AC Adapter Kit ACK800**

This kit lets you power the camera from any standard household power outlet. Recommended to power a camera for an extended period of time or when connecting to a computer.

- **Battery and Charger Kit CBK4-300**

This dedicated battery charger kit includes both a charger unit and four rechargeable AA-size NiMH (nickel metal hydride) batteries. Convenient when taking or playing back large numbers of images.

- **NiMH Battery NB4-300**

A set of four rechargeable AA-size NiMH batteries. (This camera requires two batteries.)

■ Other Accessories

• SD Memory Card

SD Memory Cards are used to store images recorded by the camera. Canon brand cards are available in 128 MB and 512 MB capacities.

• Interface Cable IFC-400PCU

Use this cable to connect the camera to a computer, Compact Photo Printer (SELPHY series), or to a Bubble Jet printer (refer to your Bubble Jet printer user guide).

• AV Cable AVC-DC300

Use this cable to connect the camera to a TV set.

• Waterproof Case WP-DC16

When you attach this waterproof case to the camera, you can use it to take underwater shots at depths of up to 40 meters (130 feet), and of course it is ideal for taking worry-free pictures in the rain, at the beach, or on the ski slopes.

Direct Print Compatible Printers

Canon offers the following separately sold printers for use with the camera. You can produce photo quality prints quickly and easily by connecting them to the camera with a single cable and operating the camera's controls.

- Compact Photo Printers (SELPHY series)
- Bubble Jet Printers (PIXMA series)

For more information, visit your nearest Canon retailer.

Use of genuine Canon accessories is recommended.

This product is designed to achieve excellent performance when used with genuine Canon accessories. Canon shall not be liable for any damage to this product and/or accidents such as fire, etc., caused by the malfunction of non-genuine Canon accessories (e.g., a leakage and/or explosion of a battery pack). Please note that this warranty does not apply to repairs arising out of the malfunction of non-genuine Canon accessories, although you may request such repairs on a chargeable basis.

Learning More

Components Guide

■ Front View

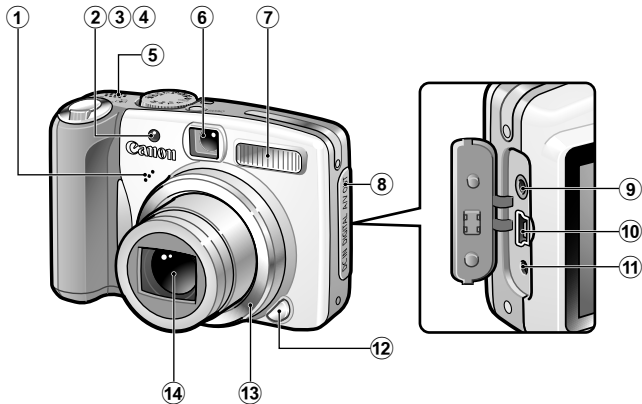

- ① Microphone
- ② AF-assist Beam (p. 45)
- ③ Red-Eye Reduction Lamp (p. 88)
- ④ Self-Timer Lamp (p. 66)
- ⑤ Speaker
- ⑥ Viewfinder Window
- ⑦ Flash (p. 64)
- ⑧ Terminal Cover
- ⑨ A/V OUT (Audio/Video output) Terminal (p. 146)
- ⑩ DIGITAL Terminal (p. 26)
- ⑪ DC IN (Power input) Terminal (p. 174)
- ⑫ Ring Release Button (p. 177)
- ⑬ Ring (p. 177)
- ⑭ Lens

■ Back View

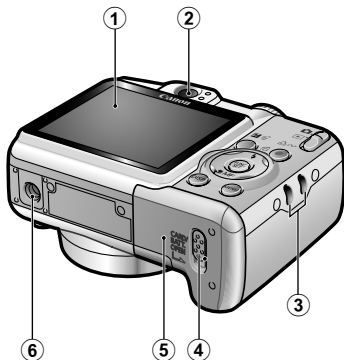

- ① LCD Monitor (p. 49)
- ② Viewfinder
- ③ Wrist Strap Mount
- ④ Memory Card Slot / Battery Cover Lock (pp. 8, 10)
- ⑤ Memory Card Slot / Battery Cover (pp. 8, 10)
- ⑥ Tripod Socket



The LCD monitor may be covered with a thin plastic film for protection against scratches during shipment. If so, remove the film before using the camera.

Using the Viewfinder

The viewfinder can be used to conserve power by turning the LCD monitor off (p. 49) while shooting.

■ Controls

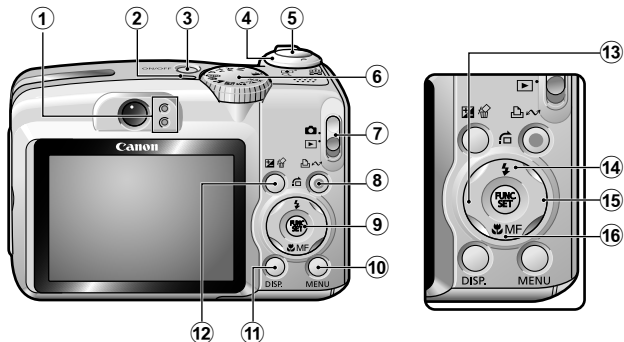

- ① Indicators (p. 41)
- ② Power Lamp
- ③ Power Button (p. 14)
- ④ Zoom Lever (pp. 59, 122)
Shooting: (Wide Angle)/ (Telephoto)
Playback: (Index)/ (Magnify)
- ⑤ Shutter Button (p. 14)
- ⑥ Mode Dial (pp. 14, 73)
- ⑦ Mode Switch (p. 14)
- ⑧ (Print/Share) Button (pp. 22, 29, 114)
- ⑨ **FUNC./SET** Button (p. 42)
- ⑩ **MENU** Button (p. 43)
- ⑪ **DISP.** Button (p. 49)
- ⑫ (Exposure)/ (Single Image Erase) Button (pp. 21, 101)
- ⑬ Button
- ⑭ (Flash)/ (Jump)/ Button (pp. 64, 124)
- ⑮ Button
- ⑯ (Macro)/ **MF** (Manual Focus)/ Button (pp. 65, 96)

Indicators

The camera indicators on the back of the camera will light or blink under the following conditions.

• Upper Indicator

- Green:** Ready to shoot (camera beeps twice)
- Blinking Green:** Image recording/reading/erasing/transferring (when connected to a computer)
- Orange:** Ready to shoot (flash on)
- Blinking Orange:** Ready to shoot (camera shake warning), charging flash

• Lower Indicator

- Yellow:** Macro mode/Manual focus mode/AF lock mode
- Blinking Yellow:** Focusing difficulty (camera beeps once)



Never do the following while the indicator blinks green. These actions may corrupt image data.

- Shake or jolt the camera
- Shut off the power, or open the memory card slot/battery cover

Power Saving Function

This camera is equipped with a power saving function. The power will shut off in the following circumstances. Press the power button again to restore power.

Shooting Mode	Powers down approximately 3 minutes after the last control is accessed on the camera. The LCD monitor automatically turns off 1 minute* after the last control is accessed even if [Auto Power Down] is set to [Off]. Press any button other than the power button or change the camera orientation to turn the LCD monitor back on.
Playback Mode Connected to a Printer	Powers down approximately 5 minutes after the last control is accessed on the camera.

* This time can be changed.



- The power saving function will not activate during an Auto Play or while the camera is connected to a computer.
- The power saving function settings can be changed (p. 47).

Basic Operations

Menus and Settings

Settings for the shooting or playback modes or such camera settings as the print settings, date/time and sounds are set using the FUNC. menu or the Rec., Play, Print or Set up menu.

■ **Button** (FUNC. Menu)

This menu sets many of the common shooting functions.

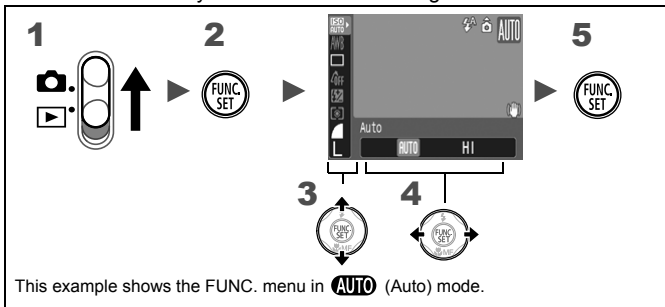

1 Set the mode switch to .

2 Press the button.

3 Use the or button to select a menu item.

- Some items may not be selectable in some shooting modes.

4 Use the or button to select an option for the menu item.

- You can select further options with the **DISP.** button for some options.
- After selecting an option, you can press the shutter button to shoot immediately. After shooting, this menu will appear again, allowing you to adjust the settings easily.

5 Press the button.

■ **Button** (Rec., Play, Print and Set up Menus)

Convenient settings for shooting, playback or printing can be set with these menus.

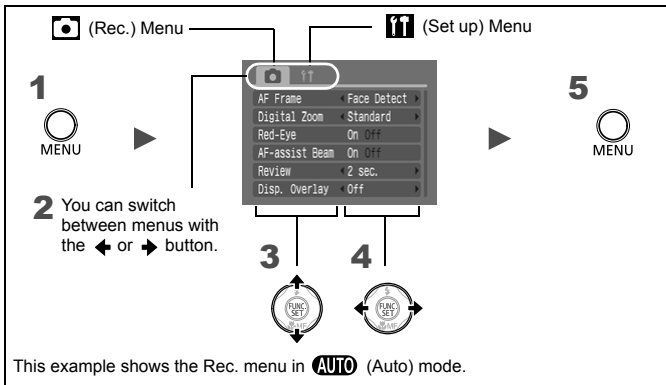

1 Press the  **button.**

2 Use the **←** or **→** button to switch between menus.

- You can also use the zoom lever to switch between menus.
- The following menus are displayed.

Shooting:  Rec. /  Set up

Playback:  Play /  Print /  Set up

3 Use the **↑** or **↓** button to select a menu item.

- Some items may not be selectable in some shooting modes.

4 Use the **←** or **→** button to select an option.

- Menu items followed by an ellipsis (...) can only be set after pressing the **FUNC./SET** button to display the next menu. Press the **FUNC./SET** button again to confirm the setting, then press the **MENU** button to return to the menu screen.











5 Press the  **button.**

Menus and Default Settings

See *Functions Available in Each Shooting Mode*









FUNC. Menu







The icons shown here indicate the default settings (factory settings).

Menu Item	Page	Menu Item	Page
 ISO Speed	p. 100	 Metering Mode	p. 102
 White Balance	p. 104	 Compression (Still image)	p. 57
 Drive Mode	p. 87	 Recording Pixels (Still image)	p. 57
 My Colors	p. 107	 Recording Pixels (Movie)	p. 81
 Flash Adjustment	p. 110		
 Flash Output	p. 111		









Rec. Menu

*Default setting

Menu Item	Options	Page/Topic
AF Frame		
 /  /  / 	Face Detect*/AiAF/Center	p. 90
 /  /  / 	Center*/FlexiZone/Face Detect/AiAF	
P / Tv / Av / M	Center*/FlexiZone/Face Detect/AiAF	
AF Frame Size	Normal*/Small	p. 92
Digital Zoom		
(Still image)	Standard*/Off/1.6x/2.0x	p. 60
(Movie)	Standard*/Off (In standard movie mode only)	
Flash Sync	1st-curtain/2nd-curtain	p. 112
Slow Synchro	On/Off*	p. 89
Flash Adjust	Auto*/Manual	p. 109
Red-Eye	On*/Off	p. 88

Menu Item	Options	Page/Topic
Safety FE	On*/Off	p. 113
Spot AE Point	Center*/AF Point	p. 103
MF-Point Zoom	On*/Off	p. 96
Safety MF	On*/Off	p. 97
AF-assist Beam	On*/Off	p. 151
Review	Off/2*–10 seconds/Hold	You can set the length of time images display after being shot (p. 16).
Disp. Overlay		
(Still image)	Off*/Grid Lines/3 : 2 Guide/Both	p. 117
(Movie)	Off*/Grid Lines	
IS Mode		
(Still image)	Continuous*/Shoot Only/ Panning/Off	p. 68
(Movie)	Continuous*/Off	
Converter	None*/WC-DC58N/ TC-DC58N/250D	p. 179
Date Stamp	Off*/Date/Date & Time	p. 71
Set  button	 /  /  /  / 	p. 114

Play Menu 

Menu Item	Page
 Auto Play	p. 129
 Red-Eye Correction	p. 130
 Resize	p. 134
 Sound Memo	p. 136
 Protect	p. 137
 Rotate	p. 127
 Erase all	p. 138
 Transfer Order	p. 144
 Transition	p. 128

Print Menu 

Menu Item	Page
Print	p. 139
Select Image & Qty.	
Select All Images	
Clear All Selections	
Print Settings	



Set up Menu 

*Default setting

Menu Item	Options	Page/Topic
Mute	On/Off*	Set to [On] to silence all operation sounds except for the warning sounds.
Volume	Off/1/2*/3/4/5	Adjusts the volume of the start-up sound, operation sound, self-timer sound, shutter sound and playback sound. The volume cannot be adjusted if [Mute] is set to [On].
Start-up Vol.		Adjusts the volume of the start-up sound when the camera is turned on.
Operation Vol.		Adjusts the volume of the operation sound that beeps when any button other than the shutter button is pressed.
Selftimer Vol.		Adjusts the volume of the self-timer sound played 2 sec. before the shutter is released.

Menu Item	Options	Page/Topic
Shutter Volume		Adjusts the volume of the sound played when the shutter releases. The shutter sound does not play when a movie is recording.
Playback Vol.		Adjusts the playback volume of movies and sound memos.
Start-up Image	On*/Off	Sets whether or not the Start-up Image appears when the camera is powered on.
Power Saving		p. 41
Auto Power Down	On*/Off	Sets whether or not the camera automatically powers down after a set period of time elapses without the camera being operated.
Display Off	10 sec./20 sec./30 sec./1 min.* /2 min./3 min.	Sets the length of time before the LCD monitor turns off when no camera operation is performed.
Date/Time		p. 12
Format		You can also select a low level format (p. 56).
File Numbering	Continuous*/Auto Reset	p. 120
Create Folder		p. 118
Create New Folder	Check mark (On)/ No check mark (Off)	Creates a folder during the next shooting session.
Auto Create	Off*/Daily/ Monday-Sunday/ Monthly	You can also set an auto creation time.
Auto Rotate	On*/Off	p. 115
Distance Units	m/cm* /ft/in	Sets the units for the MF indicator distance unit (p. 96).

Menu Item	Options	Page/Topic
Lens Retract	1 minute* / 0 seconds	Sets the lens retraction timing when switching from shooting mode to playback mode.
Language		p. 13
Video System	NTSC/PAL	p. 146
Print Method	Auto*/ 	See below* ¹ .
Reset All		p. 55

*1 You can change the printer connection method. There is usually no need to change the settings, but select  when you print an image recorded in the  (Widescreen) mode at the full page setting for wide paper using a Canon SELPHY CP750/740/730/CP720/CP710/CP510 Compact Photo Printer. Since this setting is saved even when the power is turned off, ensure that you return the setting to [Auto] to print other image sizes. (However, it cannot be changed while the printer is connected.)

Using the LCD Monitor

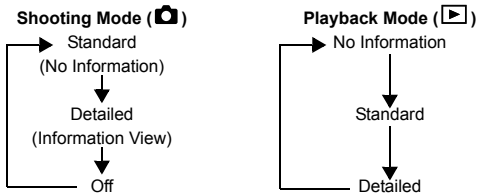

1 Press the button.

- The display mode changes as follows with each press.



- The shooting information displays for approximately 6 sec. when a setting is changed, regardless of the selected display mode.









- The LCD monitor on or off setting is retained even after the camera power is turned off.
- The LCD monitor does not shut off in the  or  mode.
- The LCD monitor will not switch to the detailed display in the Magnified Display (p. 122) or the index playback mode (p. 123).

Night Display

When shooting in dark conditions, the camera automatically brightens the LCD monitor to suit the brightness of the subject*, making it easier to frame the subject.

* Although noise may appear and the movement of the subject shown on the LCD monitor may appear somewhat jagged, there is no effect on the recorded image. The brightness of the image displayed in the monitor, and the brightness of the actual image recorded will be different.

	Create Folder		p. 118
③	Stills: Recordable Shots		
	Movies: Remaining Time/Elapsed Time		
	Camera Shake Warning	 (Red)	
④	AE Lock/FE Lock		pp. 98, 99
	Shutter Speed*	15–1/2000	pp. 83, 86
	Aperture Value*	F2.8–F8.0	pp. 85, 86
	Exposure Compensation	 -2 ... +2	p. 101
	Macro		p. 65
	AF Lock/Manual Focus		pp. 95, 96

* Displays when the shutter button is pressed halfway. During flash photography, however, the camera automatically readjusts the ISO speed, shutter speed or aperture setting to an optimal setting, which may cause the playback information to differ from the displayed information.



If the indicator blinks orange and the camera shake warning icon  displays, this indicates that a slow shutter speed may have been selected due to insufficient illumination. Use the following methods to shoot:

- Set the IS mode to any setting other than [off] (p. 68)
- Raise the ISO speed (p. 100)
- Select a setting other than  (flash off) (p. 64)
- Attach the camera to a tripod or other device

Playback Information (Playback Mode)

■ Standard



①	Displayed image number/Total number of images	—
	Folder Number-File Number	p. 121
	Compression (Still Images)	p. 57
	Recording Pixels (Still Images)	p. 57
	Movie	p. 125
②	Red-Eye Correction/Resize	pp. 130, 134
	WAVE Format Sound	p. 136
	Protection Status	p. 137
	Shooting Date/Time	p. 71

■ Detailed

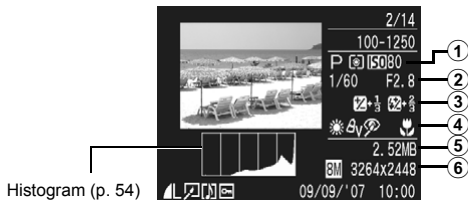

Histogram (p. 54)

①	Shooting Mode		p. 74
	Metering Mode		p. 102
	ISO Speed		p. 100

②	Shutter Speed	15–1/2000	pp. 83, 86
	Aperture Value	F2.8–F8.0	pp. 85, 86
	Recording Pixels/Frame Rate (Movies)		p. 57
③	Exposure Compensation		p. 101
	Flash Exposure Compensation/Flash Output		pp. 110, 111
	White Balance		p. 104
	My Colors		p. 107
④	Red-Eye Correction Function		p. 130
	AF Lock/Manual Focus		pp. 95, 96
	Macro		p. 65
⑤	File size		p. 192
⑥	Still Image: Recording Pixels		pp. 190, 191
	Movies: Movie Length		

The following information may also be displayed with some images.

	A sound file in a format other than the WAVE format is attached or the file format is not recognized.
	JPEG image not conforming to Design rule for Camera File System Standards (p. 187)
	RAW image
	Image recording pixel setting not recognized



- Information for images shot on other cameras may not display correctly.
- Overexposure Warning
In the following cases, overexposed portions of the image blink.
 - When reviewing an image right after shooting in the LCD monitor (information view)
 - When using the detailed display mode of the Playback mode

Histogram Function

The histogram is a graph that allows you to check the brightness of the image. The greater the bias toward the left in the graph, the darker the image. The greater the bias toward the right, the brighter the image.

If the image is too dark, adjust the exposure compensation to a positive value. Similarly, adjust the exposure compensation to a negative value if the image is too bright (p. 101).

Sample Histograms



Dark Image



Balanced Image

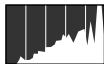







Bright Image

Resetting Settings to Their Default Values



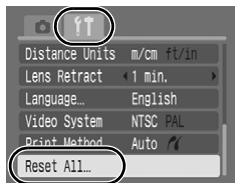

1 Select [Reset All].

1. Press the  button.
2. Use the  or  button to select [MENU] Menu.
3. Use the  or  button to select [Reset All].
4. Press the  button.



2 Accept the setting.

1. Use the  or  button to select [OK]
2. Press the  button.

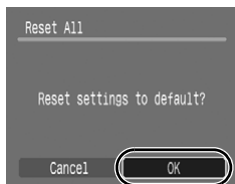

- Settings cannot be reset when the camera is connected to a computer or to a printer.
- The following cannot be reset.
 - Shooting mode
 - The [Date/Time], [Language] and [Video System] options in the [MENU] menu (pp. 47, 48)
 - White balance data recorded with the custom white balance function (p. 105)

Formatting Memory Cards









You should always format a new memory card or one from which you wish to erase all images and other data.







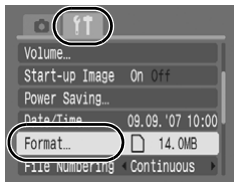

Please note that formatting (initializing) a memory card erases all data, including protected images and other file types.

1 Select [Format].

1. Press the  button.
2. Use the  or  button to select [] Menu.
3. Use the  or  button to select [Format].
4. Press the  button.



2 Accept the setting.

1. Use the  or  button to select [OK]
2. Press the  button.
 - To perform a low level format, use the  button to select [Low Level Format] and the  or  button to add a check mark.
 - You can stop formatting a card when [Low Level Format] is selected by pressing the **FUNC./SET** button. You can still use a card without problem when formatting is halted, but its data will be erased.

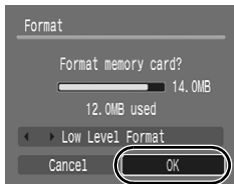

Low Level Format

We recommend you select [Low Level Format] when you think that the recording/reading speed of a memory card has dropped. A low level format may require 2 to 3 minutes with some memory cards.

Commonly Used Shooting Functions

Changing the Recording Pixels/ Compression (Still Images)



➔ See *Functions Available in Each Shooting Mode* (p. 206).

Shooting Mode **AUTO** **SCN** **P Tv Av M**

1 Select a resolution setting.

1. Press the button.
2. Use the or button to select and the or button to change the option.
3. Press the button.







2 Select a compression setting.

1. Press the button.
2. Use the or button to select and the or button to change the option.
3. Press the button.







Approximate Values for Recording Pixels

Recording Pixels				Purpose*
L (Large)	8M	3264 x 2448 pixels	High   Low	Printing to about A3-size 297 x 420 mm (11.7 x 16.5 in.)
M1 (Medium 1)	5M	2592 x 1944 pixels		Printing to about A4-size 210 x 297 mm (8.3 x 11.7 in.) Printing to about Letter-size 216 x 279 mm (8.5 x 11 in.)
M2 (Medium 2)	3M	2048 x 1536 pixels		Printing to about A5-size 148 x 210 mm (6 x 8.3 in.)
M3 (Medium 3)	2M	1600 x 1200 pixels		Print postcard-size prints 148 x 100 mm (6 x 4 in.) Print L-size prints 119 x 89 mm (4.7 x 3.5 in.)
S (Small)	0.3M	640 x 480 pixels		Send images as e-mail attachments or shoot more images
 or  (Postcard)	1600 x 1200 pixels		When printing to postcards (p. 70).	
W (Widescreen)	3264 x 1832 pixels		Printing on wide size paper (you can check the composition at a 16:9 aspect ratio. Areas that will not be recorded appear on the LCD monitor as a black border.)	

• : Approximate number of recording pixels. (M is short for megapixels.)

* Paper sizes vary according to region.

Approximate Values for Compression Settings

Compression		Purpose
 Superfine	High Quality	Shoot higher quality images
 Fine		Shoot normal quality images
 Normal		Normal



• See *Image Data Sizes (Estimated)* (p. 192).

• See *Memory Cards and Estimated Capacities* (p. 190).



Shooting with the Optical Zoom

 See *Functions Available in Each Shooting Mode* (p. 206).

Shooting Mode **AUTO**        **P Tv Av M**

The zoom can be adjusted from 35 mm – 210 mm (focal length) in 35mm film equivalent terms. The zoom bar will display while you adjust the zoom.

1 Press the zoom lever toward or .

-  **Wide Angle:** Zooms out from the subject.
-  **Telephoto:** Zooms in on the subject.



Using the Digital Zoom/Digital Tele-Converter

 See *Functions Available in Each Shooting Mode* (p. 206).

Shooting Mode **AUTO**       * **P Tv Av M**



* Digital tele-converter cannot be set.

You can combine digital zoom with optical zoom when shooting.

The available shooting characteristics and focal lengths (35mm film equivalent) are as follows:

Selection	Focal Length	Shooting Characteristics
Standard	35 – 840 mm	Enables shooting at zoom factors of up to 24x with digital and optical zoom combined. In movie mode, only the Standard mode can be selected.
Off	35 – 210 mm	Enables shooting without digital zoom.
1.6x	56 – 336 mm	Digital zoom is fixed at the selected zoom factor, and the focal length shifts to maximum telephoto. This enables a faster shutter speed and less chance of camera shake than a shot taken at the same angle of view with [Standard] or [Off].
2.0x	70 – 420 mm	



- The digital zoom cannot be used when the LCD monitor is turned off.
- The digital zoom cannot be used in  or  (Postcard), or  (Widescreen) modes.



Shooting with the Digital Zoom

1 Select [Digital Zoom].

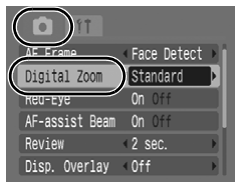
1. Press the  button.
2. In the  menu, use the  or  button to select [Digital Zoom].



2 Accept the setting.

1. Use the  or  button to select [Standard].
2. Press the  button.

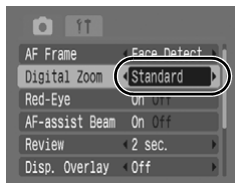

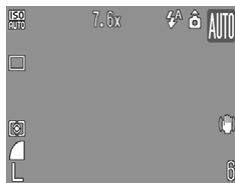

3 Press the zoom lever toward and shoot.

- The combined digital and optical zoom setting will display in the LCD monitor.
- The image may appear coarse depending upon the selected recording pixels (the zoom factor appear in blue).
- Press the zoom lever toward  to zoom out.



Safety Zoom Zone



Depending on the number of recording pixels set, you can shift from optical zoom to digital zoom without pausing up to a factor where the image quality does not deteriorate (Safety Zoom).

The  displays when reaching the maximum zoom factor without image deterioration (not available in ).

Safety Zoom factor

Recording pixels	Optical Zoom	Digital Zoom
L	6.0x →	
M1		7.6x →
M2		9.6x →
M3		12x →
S		24x →

Zoom Bar Colors

-  White: Optical Zoom (Zone without deterioration)
-  Yellow: Digital Zoom (Zone without deterioration)
-  Blue: Digital Zoom (Zoom with deterioration)

Shooting with the Digital Tele-Converter



The digital tele-converter feature uses digital zoom to achieve the effects of a tele-converter (a lens used in telephoto shooting).

1 Select [Digital Zoom].

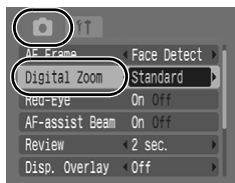
1. Press the  button.
2. In the  menu, use the  or  button to select [Digital Zoom].



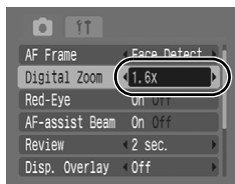

2 Accept the setting.

1. Use the  or  button to select [1.6x] or [2.0x].
2. Press the  button.



3 Adjust the angle of view with the zoom lever and shoot.

-  will appear on the LCD monitor.
- The image may appear coarse depending upon the selected recording pixels (the  icon and the zoom factor appear in blue).



⚡ Using the Flash



➔ See *Functions Available in Each Shooting Mode* (p. 206).

Shooting Mode

AUTO



SCN*



P

Tv

Av

M

* Cannot be set in mode.

1 Press the ⚡ button.

1. Use the or button to change the flash mode.

- : [Auto]
- : [On]
- : [Off]

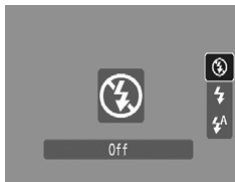

You are recommended to shoot with the camera attached to a tripod or other device if the camera shake warning icon appears.



When the LCD monitor is on and flash recharging begins, the indicator blinks orange and the LCD monitor turns off. When recharging ends, the indicator turns off and the LCD monitor turns on. The time required for flash recharging will change depending on usage conditions and remaining battery power.

Shooting Close-ups (Macro)





 See *Functions Available in Each Shooting Mode* (p. 206).

Shooting Mode **AUTO**        **P** Tv Av M

* Cannot be set in  mode.

Use this mode to shoot close-ups of flowers or small items. At maximum wide angle, the image area is 24 x 18 mm (0.94 x 0.71 in.) when at the minimum focusing distance (1 cm from the end of the lens to the subject).

1 Press the button.

- Use the  or  button to select .
 - The zoom bar will display while you adjust the zoom. In macro mode the bar will appear yellow when the zoom range prohibits focusing. The  icon will gray out and the image range becomes that of normal shooting mode.



To Cancel the Macro Mode

Press  and use the  or  button to select  (Normal).



- Use the LCD monitor to compose close-ups in macro mode since images composed with the viewfinder may be off-center.
- Using the flash in macro mode may cause image edges to darken.

Using the Self-Timer



➔ See *Functions Available in Each Shooting Mode* (p. 206).

Shooting Mode **AUTO**

* Cannot be set in mode.

You can set the time delay and the numbers of shots you wish to take in advance.

	<p>10 sec. Self-Timer: shoots 10 seconds after you press the shutter button.</p> <ul style="list-style-type: none"> • 2 seconds before the shutter releases, the self-timer lamp and sound speed up.
	<p>2 sec. Self-Timer: shoots 2 seconds after you press the shutter button.</p> <ul style="list-style-type: none"> • The self-timer sound beeps quickly when you press the shutter button and the shutter releases 2 seconds later.
	<p>Custom Timer: you can change the delay time (0–10, 15, 20, 30 sec.) and number of shots (1–10).</p> <ul style="list-style-type: none"> • When [Delay] is set to 2 or more seconds, the self-timer sound beeps quickly 2 seconds before the shutter releases. When [Shots] is set to more than 1, the self-timer sound only beeps before the first shot.

1 Configure the self-timer mode.

1. Press the button.
2. Use the or button to select and the or button to change the option.
3. Press the button.

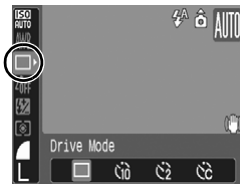









2 Shoot.

- When the shutter button is pressed fully, the self-timer will activate and the self-timer lamp will blink (when using red-eye reduction, it will stay lit for the last 2 seconds).

To Cancel the Self-Timer: Select .







Changing the Delay Time and Number of Shots (🔁)

1 Select 🔁.

1. Press the  button.
2. Use the  or  button to select  and choose  with the  or  button.
3. Press the  button.



2 Accept the setting.

1. Use the  or  button to select [Delay] or [Shots] and change the settings with the  or  button.
2. Press the  button.
3. Press the  button.

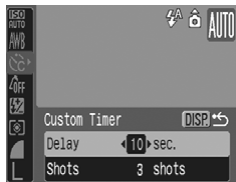

If the [Shots] option is set to 2 or more shots, the following occurs.

- The exposure and white balance are locked at the settings selected for the first shot.
- If the flash is used, the interval between shots lengthens because the flash must charge.
- The interval between shots may lengthen when the built-in memory of the camera fills.
- Shooting will automatically cease if the memory card becomes full.



Setting the Image Stabilizer Function

 See *Functions Available in Each Shooting Mode* (p. 206).

Shooting Mode **AUTO**        * **P Tv Av M**

* Only [Continuous] can be set.

The lens shift type image stabilizer function allows you to minimize the camera shake effect (blurred images) when you shoot distant subjects that have been magnified or when you shoot in dark conditions without a flash.



	Continuous	You can check the effect of the IS mode on image blur on the LCD monitor since the IS mode runs continually. This makes it easier to compose images and focus on subjects.
	Shoot Only	IS mode is only activated when the shutter button is pressed, so subjects will be captured with reduced blur even if their movements on the LCD monitor are not smooth.
	Panning	This option only stabilizes the effect of up and down camera motions on the image. This option is recommended for shooting objects moving horizontally.

1 Select [IS Mode].

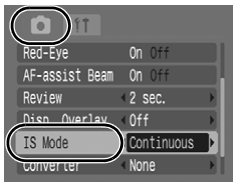
1. Press the  button.
2. In the [] menu, use the  or  button to select [IS Mode].







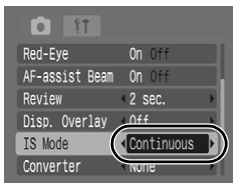

2 Accept the setting.

1. Use the  or  button to select [Continuous], [Shoot Only], [Panning] or [Off].
2. Press the  button.



LCD Monitor Icons

[Continuous]	[Shoot Only]	[Panning]	[Converter] setting in Rec. menu	Reference Page
			None	p. 179
			WC-DC58N/ TC-DC58N/250D	



- Camera shake may not be fully corrected when shooting with slow shutter speeds, such as with evening shots. Use of a tripod is recommended.
- If camera shake is too strong, it may not be fully corrected.
- Hold the camera horizontally while panning (stabilization does not work when the camera is held vertically).
- If you select [Shoot Only] or [Panning] in shooting mode (still images) and then switch to movie mode, the setting will change to [Continuous].









Configuring the Postcard Mode

 See *Functions Available in Each Shooting Mode* (p. 206).

Shooting Mode **AUTO**        **P**   

You can shoot images with the optimal settings for postcards by composing them inside the print area (width-to-height ratio of approximately 3:2) shown in the LCD monitor.

1 **Select** .

1. Press the  button.
2. Use the  or  button to select  and choose  with the  or  button.
3. Press the  button.



- The area that will not print displays in gray.
- The recording pixel and compression settings are fixed (2M: 1600 x 1200, Fine).



The digital zoom or the digital tele-converter cannot be used in this mode.



For printing instructions, refer to the *Direct Print User Guide*.









Embedding the Date in the Image Data

 See *Functions Available in Each Shooting Mode* (p. 206).

Shooting Mode **AUTO**      **SCN**   **P Tv Av M**

You can embed the date in the image data when  (Postcard) is selected.

1 Select .

1. Press the  button.
2. Use the  or  button to select  and choose  with the  or  button.
3. Press the  button.







2 Select [Date Stamp].

1. Press the  button.
2. In the  menu, use the  or  button to select [Date Stamp].



3 Set the date and time.

1. Use the  or  button to select [Date] or [Date & Time].
2. Press the  button.
LCD Monitor Display
 -  : [Off]
 -  : [Date]/[Date & Time]

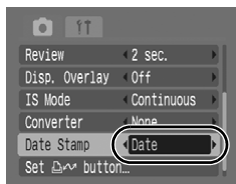

- Ensure that the camera's date/time is set beforehand (p. 12).
- The date stamp cannot be deleted from the image data once it has been embedded.



To imprint the date on all but  (postcard) size images, use the supplied software (ZoomBrowser EX or ImageBrowser) or printer settings. For details, please see the user guide for each product.

Shooting Using the Mode Dial

Mode Dial

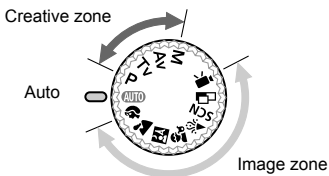

■ Auto

AUTO The camera automatically selects settings. (p. 14)

■ Image zone

When a shooting mode appropriate for the shooting conditions is selected, the camera automatically adjusts settings for optimal shooting. (p. 74)



Portrait



Landscape



Night Snapshot



Kids & Pets



Indoor



Special Scene (p. 75)



Stitch Assist (p. 77)



Movie (p. 79)

■ Creative zone

With these settings, you select parameters such as the shutter speed or aperture stop to achieve a range of effects.



Program AE (p. 82)



Setting the Shutter Speed (p. 83)



Setting the Aperture (p. 85)



Manually Setting the Shutter Speed and Aperture (p. 86)

Shooting Modes for Specific Scenes

 See *Functions Available in Each Shooting Mode* (p. 206).

Shooting Mode **AUTO**      **SCN**   **P** **Tv** **Av** **M**

When a shooting mode appropriate for the shooting conditions is selected, the camera automatically adjusts settings for optimal shooting.

1 Set the mode dial to , , , or .

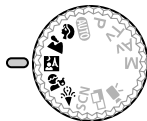

Portrait

Produces a soft effect when photographing people.



Landscape

Optimized for shooting landscape scenes which contain both near and far subjects.

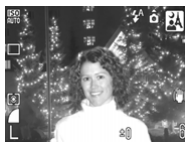

Night Snapshot

Allows you to take snapshots of people against twilight or night backgrounds by reducing the effects of camera shake even without using a tripod.



Kids&Pets

Allows you to capture subjects that move around, such as children and pets, without missing photo opportunities.



Indoor

Prevents camera shake and maintains the subject's true color when shooting under fluorescent or tungsten lighting.

SCN (Special Scene)

You can shoot with the most appropriate settings for the scene.

1 Set the mode dial to SCN.

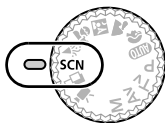

2 Use the ← or → button to select a shooting mode.



Night Scene

Allows you to capture human subjects against the backdrop of an evening sky or night scene. The flash is directed at the person and the shutter speed is slow, so both the person and the background can be beautifully shot.



Foliage

Shoots trees and leaves—such as new growth, autumn leaves or blossoms—in vivid colors.



Snow

Shoots without a blue tinge and without making people appear dark against a snowy background.



Beach

Shoots without making people appear dark near water or sand where reflected sunlight is strong.



Fireworks

Captures fireworks in the sky sharply and at optimal exposure.



Aquarium



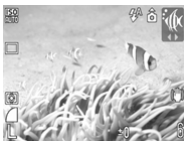



Selects the optimal ISO speed, white balance and color balance to capture fish and other items in an indoor aquarium.



Underwater

Appropriate for shooting images with Waterproof Case WP-DC16 (sold separately). This mode uses an optimal white balance setting to reduce bluish tones and record images with a natural hue.



- The shutter speed is slow in  or  mode. Always use a tripod to avoid camera shake.
- In , , ,  or  mode, the ISO speed may increase and cause noise in the image depending on the scene being shot.



Install the camera in Waterproof Case WP-DC16 to shoot underwater. You are also recommended to use this case for shooting in rainy conditions, at the beach or on the ski slopes.

Shooting Panoramic Images (Stitch Assist)

 See *Functions Available in Each Shooting Mode* (p. 206).

Shooting Mode       **SCN**   **P**  **Tv**  **Av**  **M**

Stitch Assist can be used to shoot overlapping images that can later be merged (stitched) to create one panoramic image on a computer.





The overlapping seams of several adjacent images can be joined into a single panoramic image.

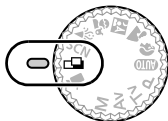

1 Set the mode dial to .



2 Select a shooting direction.

- Use the  or  button to select a shooting direction.
 - Left to right horizontally
 - ← Right to left horizontally



3 Shoot the first image in the sequence.

- The exposure and white balance are set and locked with the first image.

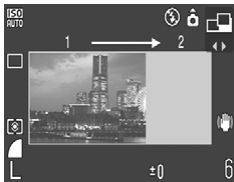

4 Compose the second image so that it overlaps a portion of the first and shoot.

- You can press the ◀ or ▶ button to return to the previously recorded image to retake the shot.
- Minor discrepancies in the overlapping portions can be corrected when the images are stitched together.

5 Repeat the procedure for additional images.

- A sequence may contain up to 26 images.

6 Press the button after the last shot.



- You cannot display the images on a TV when shooting in Stitch Assist mode.
- The settings for the first image are applied to the second image onward (except for Macro setting).



- Use PhotoStitch, a supplied software program, to merge the images on a computer.
- When the  button is pressed, you can switch between the items which you can set.
 - Exposure compensation/Shooting direction selection

Movie Shooting



 See *Functions Available in Each Shooting Mode* (p. 206).

Shooting Mode       **SCN**   **P Tv Av M**

The following movie modes are available.

The recording time will vary according to the capacity of the memory card you use (p. 191).

Standard

You can select the recording pixels and record until the memory card is full (when a super high-speed memory card is used, such as the recommended SDC-512MSH). The digital zoom can be used while shooting in this mode (p. 60).

- Maximum Size: 4 GB*/movie

Compact

Since there are few recording pixels and also the data size is small, this mode is convenient for sending movies as e-mail attachments or when the memory card capacity is low.



- Maximum Clip Length: 3 minutes

* Even if the clip size has not reached 4 GB, recording will stop at the moment the clip length reaches 1 hour. Depending on the volume and data writing speed of the memory card, recording may stop before reaching 1 hour or before the recorded data volume has reached 4 GB.

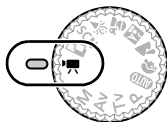
1 Set the mode dial to .



2 Select a shooting mode.

1. Use the  or  button to select a shooting mode.



3 Shoot.

- Pressing the shutter button halfway automatically sets the exposure, focus and white balance settings.
- Pressing the shutter button fully starts recording video and sound simultaneously.
- During shooting, the recording time and [●Rec] appear on the LCD monitor.
- Pressing the shutter button fully again stops recording. Recording will stop automatically under the following circumstances.
 - When the maximum recording time elapses
 - When the built-in memory or memory card becomes full



- You are recommended to use a memory card that has been formatted in your camera to shoot movies (p. 56). The memory card supplied with the camera may be used without further formatting.
- Be careful of the following while recording.
 - Do not touch the microphone (p. 38).
 - Do not press any buttons other than the shutter button. The sound that buttons make will be recorded in the movie.
 - The camera will automatically adjust the exposure and white balance to suit the shooting conditions during recording. Please note, however, that the sounds made by the camera automatically adjusting the exposure may also be recorded.
- The focus and optical zoom settings remain fixed for subsequent frames at the values selected for the first frame.









QuickTime is required to play back movies (Data type: AVI/ Compression method: Motion JPEG) on a computer (Only Windows 2000).

Changing Recording Pixels

You can change the recording pixels when the movie mode is set to  (Standard) (frame rate is fixed).





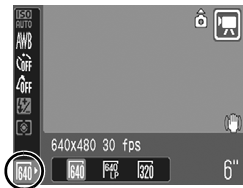

1 Select the number of recording pixels.

1. Press the  button.
2. Use the  or  button to select  and the  or  button to change the option.
3. Press the  button.



Recording Pixels and Frame Rates

Frame rates indicate the number of frames recorded or played back each second. The higher the frame rate, the smoother the appearance of motion.

 Standard	 *1	640 x 480 pixels, 30 frames/sec.
	 *2	640 x 480 pixels, 30 frames/sec. LP
		320 x 240 pixels, 30 frames/sec.
 Compact		160 x 120 pixels, 15 frames/sec.

*1 Default setting.

*2 To give priority to recording length over quality, select the option displaying [LP] (Long Play). For the same file size, you can record approximately twice the length.



- See *Memory Cards and Estimated Capacities* (p. 190).
- See *Image Data Sizes (Estimated)* (p. 192).

P Program AE



➔ See *Functions Available in Each Shooting Mode* (p. 206).

Shooting Mode **AUTO** **SCN** **P** **Tv** **Av** **M**

The camera automatically sets the shutter speed and aperture value to match the brightness of the subject. You can freely configure such settings as the ISO speed, exposure compensation and white balance.

1 Set the mode dial to P.

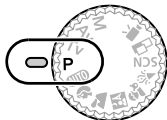

2 Shoot.



The shutter speed and aperture values are shown in red on the LCD monitor if a correct exposure cannot be obtained when the shutter button is pressed halfway. Use the following shooting methods to obtain the correct exposure and make them show in white.

- Using the flash (p. 64)
- Changing the ISO speed (p. 100)
- Changing the metering method (p. 102)

Tv Setting the Shutter Speed



➔ See *Functions Available in Each Shooting Mode* (p. 206).

Shooting Mode

AUTO SCN P Tv Av M

When you set the shutter speed, the camera automatically selects an aperture value to match the brightness of the subject. Faster shutter speeds allow you to catch an instantaneous image of a moving subject, while slower speeds create a flowing effect and allow you to shoot without a flash in dark areas.

1 Set the mode dial to Tv.



2 Configure the shutter speed.

1. Use the ◀ or ▶ button to change the shutter speed.

3 Shoot.

- If the aperture value is shown in red when the shutter button is pressed halfway, the image is underexposed (insufficient light) or overexposed (too much light). Use the ◀ or ▶ button to adjust the shutter speed until the aperture value shows in white.



The nature of CCD image sensors is such that noise in the recorded image increases at slow shutter speeds. This camera, however, applies special processing to images shot at shutter speeds of 1.3 seconds or slower to eliminate the noise, thereby producing high-quality images. (However, a certain amount of processing time may be required before the next image can be shot.)



- The aperture value and shutter speed change according to the zoom state as follows

	Shooting Mode	Aperture Value	Shutter Speed (seconds)
Maximum Wide Angle	M, Tv	f/2.8 – 3.5	15 – 1/1500
	M, Tv	f/4.0 – 8.0	15 – 1/2000
Maximum Telephoto	M, Tv	f/4.8 – 6.3	15 – 1/1500
	M, Tv	f/7.1 – 8.0	15 – 1/2000

- The fastest shutter speed for flash synchronization is 1/500 second. The camera automatically resets the shutter speed to 1/500 second if a faster speed is selected.

Shutter Speed Display

- The following shutter speeds can be set. 1/160 indicates 1/160 second. Also, 0"3 indicates 0.3 second and 2" indicates 2 seconds.

15" 13" 10" 8" 6" 5" 4" 3"2 2"5 2" 1"6 1"3 1" 0"8 0"6 0"5 0"4 0"3
 1/4 1/5 1/6 1/8 1/10 1/13 1/15 1/20 1/25 1/30 1/40 1/50 1/60
 1/80 1/100 1/125 1/160 1/200 1/250 1/320 1/400 1/500 1/640
 1/800 1/1000 1/1250 1/1500 1/1600 1/2000

Av Setting the Aperture



➔ See *Functions Available in Each Shooting Mode* (p. 206).

Shooting Mode

AUTO SCN P Tv **Av** M

The aperture adjusts the amount of light entering through the lens. When you set the aperture value, the camera automatically selects a shutter speed to match the brightness.

Selecting a lower aperture value (opening the aperture) allows you to blur the background and create a beautiful portrait. A higher aperture value (closing it) brings the entire range from foreground to background into focus. The larger the aperture value, the greater the range of the image brought into clear focus.

1 Set the mode dial to Av .

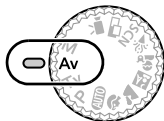

2 Configure the aperture setting.

1. Use the ◀ or ▶ button to change the aperture setting.

3 Shoot.

- If the shutter speed is shown in red when the shutter button is pressed halfway, the image is underexposed (insufficient light) or overexposed (too much light). Adjust the aperture value using the ◀ or ▶ button until the shutter speed display turns to white.



Some aperture values may not be available with certain zoom positions (p. 84).



- In this mode, the shutter speed range with synchronized flash is 1/60 second to 1/500 second. The aperture value setting may therefore be changed automatically to match the synchronized flash speed even if its value was set previously.

Aperture Value Display

- The larger the aperture value, the smaller the lens aperture.

F2.8 F3.2 F3.5 F4.0 F4.5 F4.8 F5.0 F5.6 F6.3 F7.1 F8.0

M Manually Setting the Shutter Speed and Aperture



➔ See *Functions Available in Each Shooting Mode* (p. 206).

Shooting Mode **AUTO** **SCN** **P** **Tv** **Av** **M**

You can manually set the shutter speed and aperture to shoot images.

1 Set the mode dial to M.

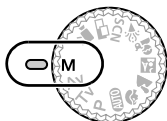

2 Configure the shutter speed and aperture setting.

1. Use the button to select shutter speed or aperture, and use the or button to change the option.

3 Shoot.

- When you press the shutter button halfway, the difference between the correct exposure* and the selected exposure appears on the LCD monitor. If the difference is more than ± 2 stops, “-2” or “+2” appears in red.

* Correct exposure levels are calculated by measuring light according to the currently selected metering mode.



- If the zoom is adjusted after these values are set, the shutter speed or aperture value may change in accordance with the zoom position (p. 84).
- The LCD monitor's brightness matches the selected shutter speed and aperture value.
When you select a fast shutter speed or shoot a subject in a dark place, the image will always be bright if the flash is set to (Flash on).

Various Shooting Methods

Continuous Shooting



➔ See *Functions Available in Each Shooting Mode* (p. 206).

Shooting Mode **AUTO** **P** **Tv** **Av** **M**

In this mode, the camera shoots continuously while the shutter button is held down. If you use the recommended memory card*1, you can shoot continuously (smooth continuous shooting) at a set shooting interval until the memory card is full (p. 190).

*Recommended Memory Card:

Super high-speed SDC-512MSH memory card (sold separately) to which low-level formatting (p. 56) is conducted immediately before shooting.

- This reflects standard shooting criteria established by Canon. Actual results may vary according to the subject and shooting conditions.
- Even if continuous shooting suddenly stops, the memory card may not be full.

1 Select

1. Press the button.
2. Use the or button to select and choose with the or button.
3. Press the button.

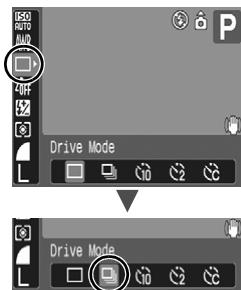

2 Shoot.

- The camera will continue to record successive images while the shutter button is held down. Recording will cease when the shutter button is released.

To Cancel Continuous Shooting

Follow step 1 to display .



- The interval between shots lengthens when the built-in memory of the camera fills.
- If the flash is used, the interval between shots lengthens because the flash must charge.

Setting the Red-Eye Reduction Function

 See *Functions Available in Each Shooting Mode* (p. 206).

Shooting Mode **AUTO**      *1   **P Tv Av M**

* 1 Cannot be set in  mode.

You can set whether or not the red-eye reduction*2 lamp automatically fires with the flash.



*2 This function reduces the red appearance of eyes when they reflect light back from the flash.

1 Select [Red-Eye].

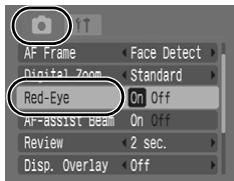
1. Press the  button.
2. In the [] menu, use the  or  button to select [Red-Eye].



2 Accept the setting.

1. Use the  or  button to select [On] or [Off].
2. Press the  button.

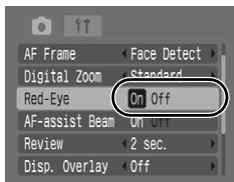

Setting the Slow Synchro Function

 See *Functions Available in Each Shooting Mode* (p. 206).

Shooting Mode

AUTO





You can shoot with the flash at slow shutter speeds. This is handy for shooting at night or under artificial lighting indoors.

1 Select [Slow Synchro].

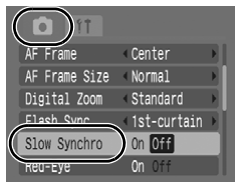

1. Press the  button.
2. In the  menu, use the  or  button to select [Slow Synchro].

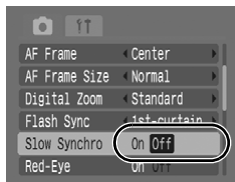

2 Set Slow Synchro.

1. Use the  or  button to select [On] or [Off].
2. Press the  button.



- In , , and  modes Slow Synchro is set to [On].
- Please note that camera shake becomes a factor when [Slow Synchro] is set to [On]. If this occurs, you are recommended to fix the camera to a tripod to shoot in this mode.

Selecting an AF Frame Mode



➔ See *Functions Available in Each Shooting Mode* (p. 206).

Shooting Mode



* Cannot be set in mode.

The AF frame indicates the area of the composition on which the camera focuses. You can set the AF frame in the following ways.

	<p>Face Detect</p>	<p>You can have the camera automatically detect the position of a face and use this data to set the focus and exposure* while shooting. In addition, the camera will meter the subject so that the face is correctly illuminated when the flash fires. If a face is not detected, shooting will take place with [AiAF].</p> <p>* Only in evaluative metering mode (p. 102).</p>
	<p>AiAF</p>	<p>The camera automatically selects between 9 AF frames to focus on according to the shooting conditions.</p>
	<p>Center</p>	<p>The camera fixes the AF frame at the center. This is convenient for making sure the focus is exactly where you want it.</p>
	<p>FlexiZone</p>	<p>Shooting mode: P/Tv/Av/M</p> <p>The camera sets the focus from an AF frame you select. This is convenient for ensuring that the intended subject is in focus.</p>

1 Select [AF Frame].

1. Press the button.
2. In the [] menu, use the or button to select [AF Frame].



2 Accept the setting.

1. Use the ← or → button to select [Face Detect], [AiAF], [Center] or [FlexiZone].
2. Press the  button.
 - Changing the AF Frame Size (p. 92)
 - Changing the AF Frame Position (p. 93)

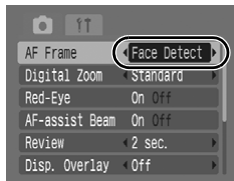

- [Face Detect] and [FlexiZone] cannot be used when the LCD monitor is turned off.
- The AF frame appears as follows (when the LCD monitor is on) when the shutter button is pressed halfway.
 - Green : Shooting preparations complete
 - Yellow : Focusing difficulty ([Center], [FlexiZone] options)
 - No AF frame : Focusing Difficulty ([Face Detect], [AiAF] options)





Face Detect Feature

- Maximum of three AF frames will be displayed at the position of the face the camera recognizes. At this point, the frame the camera judges to be the main subject appears in white while the others appear in gray. When the shutter button is pressed halfway, up to 9 green AF frames may appear.
- The camera will shoot using [AiAF] not the [Face Detect] function if a white frame fails to appear and only grey frames display, or if a face is not detected.
- The camera may mistakenly identify non-human subjects as a face.
- In certain cases, faces may not be detected.
Examples:
 - If faces are at the edge of the screen, or appear extremely small, large, dark or bright, relative to the overall composition.
 - Faces turned to the side or at a diagonal, or faces with a portion hidden.

Changing the AF Frame Size ([Center] or [Flexi-Zone])



You can change the AF frame size to better suit the size of a subject. You reduce the area used to set the focus when you reduce the AF frame to match a small subject or to focus on a particular portion of a subject.

1 Change the AF frame size.

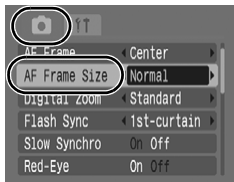
1. Press the  button.
2. In the [] menu, use the  or  button to select [AF Frame Size].



2 Accept the setting.

1. Use the  or  button to select [Normal] or [Small].
2. Press the  button.

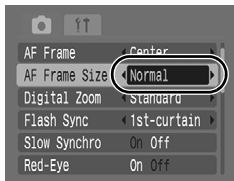

The setting is configured to [Normal] when the digital zoom or digital tele-converter is used.

Changing the AF Frame Position ([FlexiZone])

You can move the AF frame to any position (FlexiZone AF/AE). This allows you to set the focus more precisely on your target subject.

1 Press repeatedly until the AF frame turns green.

- In some shooting modes, pressing the  button switches between the following settings categories.

P	Exposure compensation/AF Frame
Tv	Shutter speed/Exposure compensation/AF Frame
Av	Aperture value/Exposure compensation/AF Frame
M	Shutter speed/Exposure compensation/AF Frame

2 Use the , , or button to move the AF frame to the desired position and press the button.

- Pressing the **MENU** button shifts the AF frame to a face detected by the camera.
- You can change the AF frame size by pressing the **DISP.** button (the change remains in effect even after the camera power is switched off).
- Continuing to press the  button causes the AF frame to return to its original position.



- When the metering option is set to [Spot], you can make the AF frame and spot metering frame correspond (p. 102).
- This option cannot be selected in manual focusing mode (p. 96).
- The AF frame returns to the center position when the power is switched off.

Shooting Hard-to-Focus Subjects (Focus Lock, AF Lock, Manual Focus, Safety MF)

 See *Functions Available in Each Shooting Mode* (p. 206).

Shooting Mode **AUTO**      **SCN***   **P**  **Av** **M**

* Cannot be used in  mode.

It may be difficult to focus on the following types of subjects.

- Subjects with extremely low contrast to the surroundings
- Scenes with a mixture of near and far subjects
- Subjects with extremely bright objects at the center of the composition
- Subjects that are moving quickly
- Subjects through glass: Try to shoot as close to the glass as possible to reduce the chances of light reflecting back off the glass.

Shooting with the Focus Lock

- 1 Aim the camera so that an object at the same focal distance as the main subject is centered in the viewfinder or in the AF frame displayed on the LCD monitor.**
- 2 Press the shutter button halfway to lock the focus.**
- 3 Keep the shutter button pressed halfway while you recompose the image and press the shutter button all the way to shoot the image.**



Shooting with the AF Lock

- 1 Turn on the LCD monitor.**
- 2 Aim the camera so that an object at the same focal distance as the main subject is centered in the AF frame.**
- 3 Press and hold the shutter button halfway and press the MF button.**
 - The **MF** icon and the MF indicator will appear on the LCD monitor, and the distance to the subject can be confirmed.
- 4 Re-aim the camera to compose the shot as desired and shoot.**

To Release the AF Lock

Press the **MF** button and use the **▲** or **▼** button to select  (Normal).



- The AF lock cannot be used in the **AUTO** and  modes.
- Since AF frames do not display in  mode, aim the camera so that the focus is on the target subject.
- When shooting with the focus lock or AF lock using the LCD monitor, setting [AF Frame] to [Center] (p. 90) makes shooting easier since the camera focuses using the center AF frame only.
- The AF lock is convenient because you can let go of the shutter button to compose the image. Moreover, the AF lock is still effective after the picture is taken, allowing you to capture a second image with the same focus.

Shooting in Manual Focus Mode

The focus can be manually set.

1 Turn on the LCD monitor.

2 Press the MF button several times.

- **[MF]** and the MF indicator are displayed.
- When the **[AF-ON]** menu's [MF-Point Zoom] is set to [On], the portion of the image in the AF frame will appear magnified*. The magnified position will differ depending on the AF Frame Mode (p. 90) setting.
 - When set to [Face Detect], [AiAF] or [Center], the center of the LCD monitor is magnified.
 - When set to [FlexiZone], the location of the AF frame displayed immediately prior to setting the manual focus will display magnified.
- * The image will not appear magnified in **[Movie]** mode, when the digital zoom or digital tele-converter is activated or when a TV is used as the display.
- * Can also be set so that the image displayed is not magnified (p. 45).
- Depending on the shooting mode, pressing the **[MF]** button will switch between the setting items as follows:

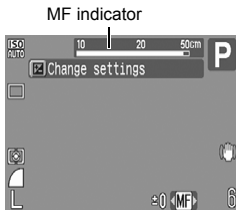

[P]	Exposure compensation/ [MF]
SCN	SCN mode/Exposure compensation/ [MF]
[Movie]	[Movie] mode/ [MF]
Tv	Shutter speed/Exposure compensation/ [MF]
Av	Aperture value/Exposure compensation/ [MF]
M	Shutter speed/Aperture value/ [MF]

3 Press the **←** or **→** button and adjust the focus.

- The MF indicator shows approximate figures. Use them as a shooting guideline only.

To Cancel the Manual Focus

Press the **MF** button and use the **↑** or **↓** button to select **△** (Normal).



Not available in **AUTO** or  modes.

Using the Manual Focus in Combination with the Auto Focus (Safety MF)

First, manual focus is used to roughly focus, then from that focus position the camera automatically focuses more accurately.

1 Select [Safety MF].

1. Press the  button.
2. In the [] menu, use the **↑** or **↓** button to select [Safety MF].

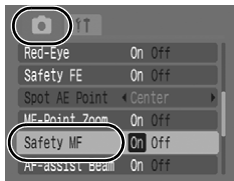

2 Accept the setting.

1. Use the **←** or **→** button to select [On].
2. Press the  button.

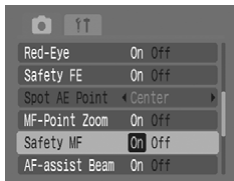

3 First focus manually and then press the shutter button halfway.

- The camera will fine-tune the focus to the best position.

4 To shoot, press the shutter button all the way down (press fully).



Not available in **AUTO** or  mode.

Locking the Exposure Setting

(AE Lock) 



 See *Functions Available in Each Shooting Mode* (p. 206).

Shooting Mode        **P Tv Av M**



You can set the exposure and focus separately. This is effective when the contrast is too strong between the subject and background or when a subject is backlit.



You must set the flash to . When the flash fires, images will be shot using the FE lock (p. 99).

- 1 Turn on the LCD monitor.**
- 2 Aim the camera at the subject on which you wish to lock the exposure.**
- 3 Press the shutter button halfway and press the  button.**
 - The  icon will display.
- 4 Re-aim the camera to compose the shot as desired and press the shutter button fully.**

To Release the AE Lock

Operate a button other than the  or  button.

Locking the Flash Exposure Setting





(FE Lock)

 See *Functions Available in Each Shooting Mode* (p. 206).



Shooting Mode

        **P** **Tv** **Av** **M**

You can lock the flash exposure so that the exposure settings are correctly set regardless of the composition of your subject.

- 1 Turn on the LCD monitor.**
- 2 Press the  button and select  (flash on).**
- 3 Aim the camera at the subject on which you wish to lock the exposure.**
- 4 Press the shutter button halfway and press the  button.**
 - The flash will pre-fire and  will display.
- 5 Re-aim the camera to compose the shot as desired and press the shutter button fully.**

To Release the FE Lock

Operate a button other than the  or  button.



The FE lock cannot be used when [Flash Adjust] is set to [Manual].

Adjusting the ISO Speed



➔ See *Functions Available in Each Shooting Mode* (p. 206).

Shooting Mode

AUTO



Raise the ISO speed to use a fast shutter speed when you wish to reduce the effects of camera shake or avoid blurry subjects, or to turn the flash off when shooting in a dark area.

	ISO AUTO	ISO HI	ISO 80	ISO 100	ISO 200	ISO 400	ISO 800	ISO 1600
AUTO	○*	○	—	—	—	—	—	—
P	○*	○	○	○	○	○	○	○
Tv	○*	—	○	○	○	○	○	○
Av	○*	—	○	○	○	○	○	○
M	—	—	○*	○	○	○	○	○

○:Available * :Default

1 Adjust the ISO Speed

1. Press the button.
2. Use the or button to select and the or button to change the setting.
3. Press the button.

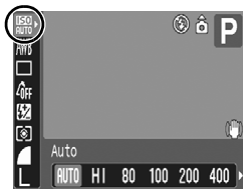

- Selecting (Auto) puts priority on image quality in setting the optimal ISO speed for the light level when shooting. Since the ISO speed setting will automatically be raised in dark places, the camera will select a faster shutter speed and reduce the chances of camera shake.
 - Selecting (High ISO Auto)* sets a higher sensitivity than for . As the shutter speed becomes even faster, camera shake and blurred photos caused by subject movement will be reduced even more than when shooting the same scene in .
- * Noise may increase in the captured image compared to .



- The camera automatically applies noise reduction processing when you shoot at a high ISO speed.
- If the camera is set at or , the ISO speed automatically set by the camera will be displayed when pressing shutter button halfway or in playback information.

Adjusting the Exposure Compensation

 See *Functions Available in Each Shooting Mode* (p. 206).

Shooting Mode

AUTO





Adjust the exposure compensation to a positive value to avoid making the subject too dark when it is backlit or shot against a bright background. Adjust the exposure compensation to a negative value to avoid making the subject too bright in night shots or when shot against a dark background.

1 Turn on the LCD monitor.

2 Press repeatedly to display the exposure compensation bar.

3 Configure the setting.

1. Use the  or  button to select a compensation setting.
2. Press .



Exposure Compensation Bar

- Each press of the  button switches between the following categories of settings that can be adjusted according to the selected shooting mode.

SCN	SCN mode/Exposure compensation
	Sequence Direction Selection/Exposure compensation
P	Exposure compensation/AF Frame* or MF
Tv	Shutter speed/Exposure compensation/AF Frame* or MF
Av	Aperture value/Exposure compensation/AF Frame* or MF

* Only with the [FlexiZone] selection for the AF frame type (p. 90).

To Cancel the Exposure Compensation



Follow step 3 to restore the compensation value to [0].

Switching between Metering Modes







 See *Functions Available in Each Shooting Mode* (p. 206).

Shooting Mode



	Evaluative	Appropriate for standard shooting conditions, including backlit scenes. The camera divides images into several zones for metering. It evaluates complex lighting conditions, such as the position of the subject, the brightness, the direct light, and the backlighting, and adjusts the settings to the correct exposure for the main subject.
	Center Weighted Avg.	Averages the light metered from the entire frame, but gives greater weight to the subject matter at the center.
	Spot	Meters within the spot metering frame.
	Center	Fixes the spot metering frame to the center of the LCD monitor.
	AF Point	Causes the position of the spot metering frame to correspond to the AF frame.





1 Change the metering method.

1. Press the  button.
2. Use the  or  button to select  and the  or  button to change the option.
3. Press the  button.





Setting the Spot Metering Frame to the Center/To Correspond with the AF Frame

1 Select [Spot AE Point].

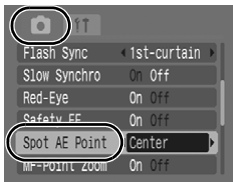
1. Press the  button.
2. In the [] menu, use the  or  button to select [Spot AE Point].



2 Accept the setting.

1. Use the  or  button to select [Center] or [AF Point].
2. Press the  button.
 - [Center]: spot metering frame appears at the center
 - [AF Point]: spot metering frame appears at the selected AF frame

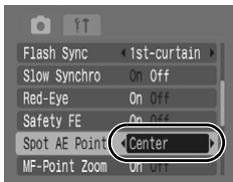









You can only select [AF Point] when the AF frame is set to [FlexiZone] (p. 90).

Adjusting the Tone (White Balance)







 See *Functions Available in Each Shooting Mode* (p. 206).

Shooting Mode **AUTO**     **SCN**   **P** **Tv** **Av** **M**



Normally, the **AWB** (Auto) white balance setting selects an optimal white balance. When the **AWB** setting cannot produce natural looking colors, change the white balance using a setting appropriate for the light source.

	Auto	Settings are automatically set by the camera.
	Day Light	For recording outdoors on a bright day.
	Cloudy	For recording under overcast, shady or twilight skies.
	Tungsten	For recording under tungsten and bulb-type 3-wavelength fluorescent lighting.
	Fluorescent	For recording under warm-white, cool-white or warm-white (3-wavelength) fluorescent lighting.
	Fluorescent H	For recording under daylight fluorescent, or daylight fluorescent-type 3-wavelength fluorescent lighting.
	Underwater	Appropriate for shooting images underwater with the Waterproof Case WP-DC16 (sold separately). This mode yields image data in the optimal white balance to record images with natural hues by reducing the bluish tone.
	Custom	For recording with the optimal white balance data memorized in the camera from a white-colored object, such as white paper or cloth.

1 Select a white balance setting.

1. Press the  button.
2. Use the  or  button to select **AWB** and the  or  button to change the option.
3. Press the  button.



The white balance setting cannot be adjusted when  or  is selected for My Colors.



Using the Custom White Balance

You can set a custom white balance to obtain the optimal setting for the shooting conditions by having the camera evaluate an object, such as a piece of white paper or cloth, or a photo-quality gray card that you wish to establish as the standard white color.

In particular, take a custom white balance reading for the following situations that are difficult for the **AWB** (Auto) setting to detect correctly.

- Shooting close-ups (Macro)
- Shooting subjects of monotone color (such as sky, sea or forest)
- Shooting with a particular source of light (such as a mercury-vapor lamp)

1 Select .

1. Press the  button.
2. Use the  or  button to select **AWB** and choose  with the  or  button.



2 Aim the camera at a piece of white paper or cloth and press .

- If you are viewing it with the LCD monitor, ensure that the center frame is completely filled with the white image. If you are using the optical viewfinder, ensure that the entire field is filled. Please note, however, that the center frame will not display when the digital zoom or  is in use.



3 Press the button.









- You are recommended to set the shooting mode to **P** and the exposure compensation setting to $[\pm 0]$ before setting a custom white balance.
The correct white balance may not be obtained when the exposure setting is incorrect (image appears completely black or white).
- Shoot with the same settings as when reading the white balance data. If the settings differ, the optimal white balance may not be set.
In particular, the following should not be changed.
 - ISO Speed
 - Flash
Setting the flash to [On] or [Off] is recommended. If the flash fires when reading the white balance data with the flash set to [Auto], make sure that you also use the flash when you shoot.
- Since the white balance data cannot be read in Stitch Assist mode, preset the white balance in another shooting mode beforehand.
- Recorded white balance data will be retained even when the camera's power is turned off.

Shooting in a My Colors Mode

 See *Functions Available in Each Shooting Mode* (p. 206).







Shooting Mode         **P** **Tv** **Av** **M**

You can change the look of an image when it is shot.

	My Colors Off	Records normally with this setting.
	Vivid	Emphasizes the contrast and color saturation to record bold colors.
	Neutral	Tones down the contrast and color saturation to record neutral hues.
	Sepia	Records in sepia tones.
	B/W	Records in black and white.
	Custom Color	Use this option to adjust contrast, sharpness and saturation before shooting.

Configuring My Colors Settings (/ / /

1 Select a My Colors setting.

1. Press the  button.
2. Use the  or  button to select  and the  or  button to change the option.
3. Press the  button.
 - Return to the shooting screen and shoot.



Setting the Camera to a Custom Color Mode

1 Select **AC**.

1. Press the **FUNC. SET** button.
2. Use the **▲** or **▼** button to select **OFF** and choose **AC** with the **◀** or **▶** button.

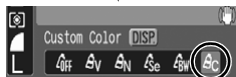

2 Select the mode.

1. Press the **DISP.** button.
2. Use the **▲** or **▼** button to select [Contrast], [Sharpness] or [Saturation].
3. Use the **◀** or **▶** button to adjust the setting.
 - The adjustment results show in the LCD monitor.
 - Press the **DISP.** button to return to the My Colors Mode selection screen.
4. Press the **FUNC. SET** button.
 - Return to the shooting screen and shoot.



Switching between Flash Adjustment Settings



➔ See *Functions Available in Each Shooting Mode* (p. 206).

Shooting Mode

AUTO



SCN



Tv

Av

M



Although the built-in flash will fire with automatic flash adjustments, it is also possible to set it so that it fires without any adjustments.

1 Select [Flash Adjust].

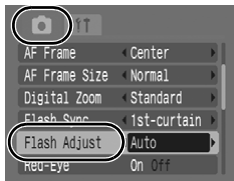
1. Press the  button.
2. In the [] menu, use the  or  button to select [Flash Adjust].



2 Accept the setting.

1. Use the  or  button to select [Auto] or [Manual].
2. Press the  button.

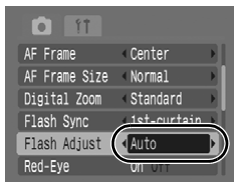

Adjusting Flash Compensation Settings

 See *Functions Available in Each Shooting Mode* (p. 206).

Shooting Mode







        **P Tv Av M**

Flash exposure compensation can be adjusted in the range of -2 to +2 stops in 1/3-stop increments.

You can combine the flash exposure compensation with the camera's exposure compensation function for balanced exposure of the background when doing flash photography.

In **Tv** and **Av** shooting modes, please set [Flash Adjust] to [Auto] (p. 109).

1 Adjust the flash compensation setting.

1. Press the  button.
2. Use the  or  button to select  and the  or  button to change the option.
3. Press the  button.



Setting the Flash Output



➔ See *Functions Available in Each Shooting Mode* (p. 206).

Shooting Mode

AUTO



SCN



P

Tv







Av

M

When shooting, the flash output can be controlled in three steps, up to FULL.

In **Tv** and **Av** shooting modes, please set [Flash Adjust] to [Manual] (p. 109).

1 Configure the flash output setting.

1. Press the  button.
2. Use the  or  button to select  and the  or  button to change the option.
3. Press the  button.

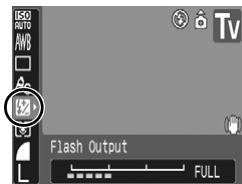

Switching the Timing at which the Flash Fires

 See *Functions Available in Each Shooting Mode* (p. 206).

Shooting Mode

AUTO        **P Tv Av M**



1st-curtain	The flash fires right after the shutter opens, regardless of the shutter speed. Usually, the 1st-curtain is used when shooting.
2nd-curtain	The flash fires right before the shutter closes. Compared with the 1st-curtain, the flash fires later and allows you to shoot images in which, for example, a car's taillights seem to trail off behind.

1 Select [Flash Sync].

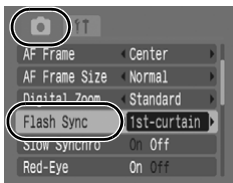
1. Press the  button.
2. In the [] menu, use the  or  button to select [Flash Sync].



2 Accept the setting.

1. Use the  or  button to select [1st-curtain] or [2nd-curtain].
2. Press the  button.

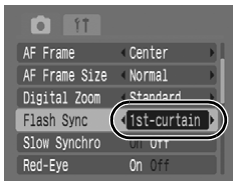

Image shot with the 1st-curtain setting



Image shot with the 2nd-curtain setting

Adjusting Exposure for Built-in Flash Shooting (Safety FE)



➔ See *Functions Available in Each Shooting Mode* (p. 206).

Shooting Mode

AUTO



P Tv Av M



The camera automatically changes the shutter speed or aperture value when the flash fires to avoid overexposing and blowing out the highlights in the scene. In **Tv** and **Av** shooting modes, ensure that the flash adjustment setting is configured to [Auto] in advance (p. 109).

1 Select [Safety FE].

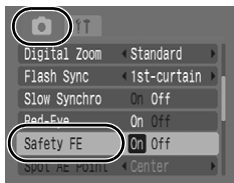
1. Press the  button.
2. In the [] menu, use the  or  button to select [Safety FE].



2 Accept the setting.

1. Use the  or  button to select [On] or [Off].
2. Press the  button.









☺ Registering Settings to the Print/Share Button

 See *Functions Available in Each Shooting Mode* (p. 206).

Shooting Mode **AUTO**        **P Tv Av M**

You can register a function that you often use when shooting with the ☺ button. The following functions can be registered.

Menu Item	Page
 Not Assigned*	—
 ISO Speed	p 100
 White Balance	p 104
 Custom White Balance	p 105







Menu Item	Page
 Digital Tele-converter	p 63
 DISP. Overlay	p 117
 Display Off	p 47

1 Select [Set ☺ button].

1. Press the  button.
2. In the [] menu, use the  or  button to select [Set ☺ button].
3. Press the  button.



2 Accept the setting.

1. Use the , ,  or  button to select the function you wish to register.
2. Press the  button.
 - If  displays to the icon's lower right, you can register the function, but you cannot to use it with some shooting modes or settings even if you press the ☺ button.

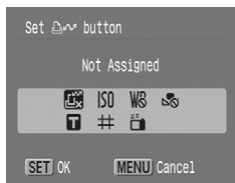





To Cancel the shortcut button

Select  in Step 2.

Using the Button

1 Press the button.

- Each time that the  button is pressed, the settings of the registered functions are switched.
 - For **ISO** and **WB**, the corresponding setup screen is displayed.
 - Each press of the  button records the white balance data with the  option. Since the frame does not appear at this point, ensure that the white paper or cloth is positioned so it appears at the center of the LCD monitor and then press the  button. After using this function once, the white balance setting changes to the custom white balance setting.

Setting the Auto Rotate Function





 See *Functions Available in Each Shooting Mode* (p. 206).

Shooting Mode

AUTO        **P Tv Av M**

Your camera is equipped with an Intelligent Orientation sensor that detects the orientation of an image shot with the camera held vertically and automatically rotates it to the correct orientation when viewing it in the LCD monitor.

1 Select **[Auto Rotate]**.

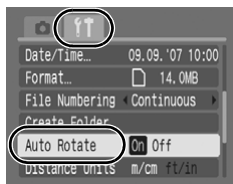

1. Press the  button.
2. Use the  or  button to select the **[Fn]** menu.
3. Use the  or  button to select **[Auto Rotate]**.





2 Accept the setting.

1. Use the **←** or **→** button to select [On] or [Off].

2. Press the  button.

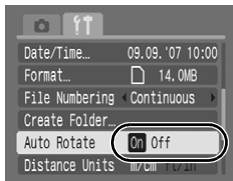
- When the Auto Rotate function is set to [On] and the LCD monitor is set to the detailed display mode during shooting,  (normal),  (right end is down) or  (left end is down) will appear in the display.



- This function may not operate correctly when the camera is pointed straight up or down. Check that the arrow  is pointing in the right direction and if it is not, then set the Auto Rotate function to [Off].
- Even if the Auto Rotate function is set to [On], the orientation of images downloaded to a computer will depend upon the software used to download the images.



When the camera is held vertically to shoot, the Intelligent Orientation sensor judges the upper end to be “up” and the lower end to be “down”. It then regulates the optimal white balance, exposure and focus for vertical photography. This function operates regardless of the on/off status of the Auto Rotate function.

Setting the Display Overlays



➔ See *Functions Available in Each Shooting Mode* (p. 206).

Shooting Mode



* Only [Grid Lines] can be set.

You can display vertical and horizontal grid lines, a 3:2 print area guide, or both on the LCD monitor while shooting to help check the position of your subject.



Grid Lines	Displays grid lines to divide the screen into 9 parts. Helps confirm the vertical and horizontal positioning of the subject.
3:2 Guide	Helps confirm the print area for a 3:2 print.* Areas outside the printable area are grayed out. * Images are still recorded at the standard aspect ratio of 4:3.
Both	Displays both the grid lines and the 3:2 guide simultaneously.

1 Select [Disp. Overlay].

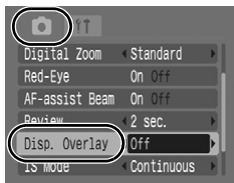

1. Press the  button.
2. In the  menu, use the  or  button to select [Disp. Overlay].

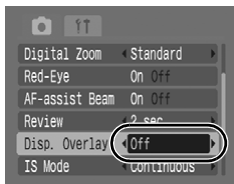

2 Accept the setting.

1. Use the  or  button to select [Off], [Grid Lines], [3:2 Guide] or [Both].
2. Press the  button.



- Only grid lines can be configured for the  or  mode.
- The grid lines and 3:2 guide will not be recorded in the image.

Creating an Image Destination (Folder)



➔ See *Functions Available in Each Shooting Mode* (p. 206).

Shooting Mode









You can create a new folder at any time and the recorded images will be automatically saved to that folder.

Create New Folder	Creates a new folder the next time you shoot images. To create an additional folder, insert the check mark again.
Auto Create	You can also specify a date and time if you wish to create a new folder using a shooting time after the specified date and time.



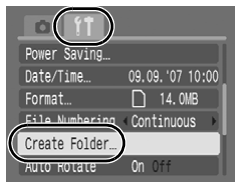

Creating a Folder the Next Time You Shoot.

1 Select [Create Folder].

1. Press the  button.
2. Use the  or  button to select the  menu.
3. Use the  or  button to select [Create Folder].
4. Press the  button.







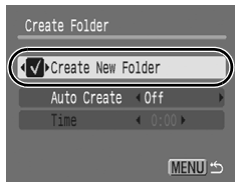

2 Accept the setting.

1. Use the  or  button to check mark [Create New Folder].
2. Press the  button.
 -  will be displayed on the LCD monitor when shooting. The symbol will cease to display after the new folder is created.









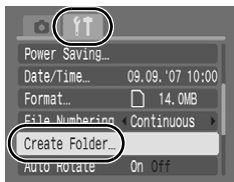



Setting the Day or Time for Automatic Folder Creation.

1 Select [Create Folder].

1. Press the  button.
2. Use the  or  button to select the  menu.
3. Use the  or  button to select [Create Folder].
4. Press the  button.



2 Accept the setting.

1. Use the  or  button to select [Auto Create] and the  or  button to select a creation date.
2. Use the  or  button to select [Time] and the  or  button to select a time.
3. Press the  button.
 -  displays when the specified time arrives. The symbol will cease to display after the new folder is created.

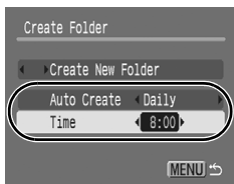

Up to 2000 images can be saved into one folder. A new folder will automatically be created when you record more than that number even if you are not creating new folders.

Resetting the File Number



➔ See *Functions Available in Each Shooting Mode* (p. 206).







Shooting Mode



The images you shoot are automatically assigned file numbers. You can select how the file number is assigned.



Continuous	<p>A number one higher than the last one recorded is assigned to the next image. This is convenient for managing all your images together on a computer because you avoid file name duplication when changing folders or memory cards.*</p> <p>* When a blank memory card is used. If a memory card with recorded data is used, the 7-digit number for the last recorded folder and image is compared with the last one on the card, and the larger of the two is utilized as the basis for new images.</p>
Auto Reset	<p>The image and folder number are reset to the starting value (100-0001).* This is convenient for managing images on a folder-by-folder basis.</p> <p>* When a blank memory card is used. If a memory card with recorded data is used, the number following the 7-digit number for the last recorded folder and image on the card is utilized as the basis for new images.</p>

1 Select [File Numbering].

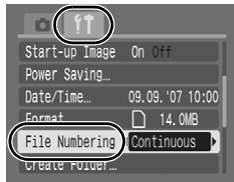
1. Press the  button.
2. Use the  or  button to select the  menu.
3. Use the  or  button to select [File Numbering].



2 Accept the setting.

1. Use the  or  button to select [Continuous] or [Auto Reset].
2. Press the  button.

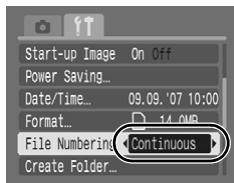

File and Folder Numbers

Recorded images are assigned consecutive file numbers starting with 0001 and ranging up to 9999, while folders are assigned numbers starting with 100 and ranging up to 999. Up to 2,000 images can be saved into a single folder.

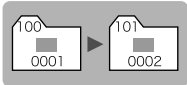
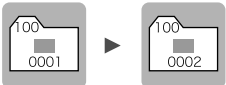
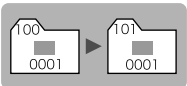
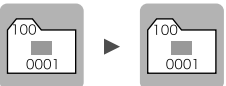
	New Folder Created	Memory Card Exchanged for Another
Continuous	Memory Card 1 	Memory Card 1 Memory Card 2 
Auto Reset	Memory Card 1 	Memory Card 1 Memory Card 2 

- Images may be saved to a new folder when there is insufficient free space even if the total number of images in a folder is less than 2,000 because the following types of images are always saved together into the same folder.
 - Images from continuous shooting
 - Self-timer images (custom)
 - Stitch Assist mode images
- Images cannot be played back when the folder numbers are duplicated or image numbers are duplicated within folders.
- Please refer to the *Software Starter Guide* for information regarding folder structures or image types.

Playback/Erasing

Q Magnifying Images



1 Press the zoom lever toward .

- **SET**  will display and a magnified portion of the image will display.
- Images can be magnified up to a factor of approximately 10x.



Approximate Location
of the Displayed Area

2 Use the **↑**, **↓**, **←** or **→** button to move around the image.

- If you press the **FUNC./SET** button while in magnified display, the camera switches to image advance mode and **SET**  will display. You can use the **←** or **→** button to advance to the next or previous image at the same level of magnification. The image advance mode is cancelled when you press the **FUNC./SET** button again.
- You can change the magnification level with the zoom lever.

To Cancel the Magnified Display

Press the zoom lever toward . (You can also cancel it immediately by pressing the **MENU** button.)



Movie frames and index playback images cannot be magnified.

☒ Viewing Images in Sets of Nine (Index Playback)



1 Press the zoom lever toward ☒.

- Up to nine images can be viewed at once in index playback.
- Use the **▲**, **▼**, **◀** or **▶** button to change the image selection.

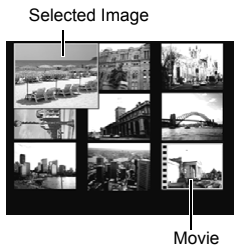

To Return to Single Image Playback

Press the zoom lever toward **Q**.

Switching between Sets of Nine Images



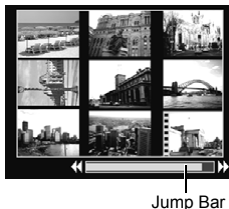

The jump bar will display if you press the zoom lever toward ☒ while in index playback and you can switch the display between sets of nine images.

- Use the **◀** or **▶** button to move to the previous or next set of 9 images.
- Hold the **FUNC./SET** button down and press the **◀** or **▶** button to jump to the first or last set.



Jumping to Images

When you have many images recorded onto a memory card, it is handy to use the five search keys below to jump over images to find the object of your search.

	Jump 10 Images	Jumps over 10 images at a time.
	Jump 100 Images	Jumps over 100 images at a time.
	Jump Shot Date	Jumps to the first image of each shooting date.
	Jump to Movie	Jumps to a movie.
	Jump to Folder	Jumps to the first image of each folder.

1 In single image playback mode, press the button.

- The camera will switch to jump search mode.
- The screen sample will vary slightly according to the search key.



Location of image currently being displayed

Number of images matching search key

2 Use the **↑** or **↓** button to select a search key and press the **←** or **→** button.





To Return to Single Image Playback
Press the **MENU** button.

Viewing Movies (Operating the Movie Control Panel)







Movies cannot be played in the index playback mode.

1 Display the movie file.

1. Use the  or  button to select a movie.
2. Press the  button.
 - Images with a  icon are movies.



2 Play the movie.



1. Use the  or  button to select .
2. Press the  button.
 - The movie will pause if you press the **FUNC./SET** button during playback. It will resume when you press the button again.
 - When playback ends, the movie stops at the last frame displayed. Press the **FUNC./SET** button to display the movie control panel.
 - You can switch between showing/hiding the playback progress bar by pressing the **DISP.** button while playing a movie.
 - If playback was halted partway through in the prior viewing session, playback will resume from the last frame displayed.

Movie Control Panel











Playback Progress Bar

Time movie was shot

Volume Level
(Adjust it with the  or  button)

Operating the Movie Control Panel

	Ends playback and returns to single image playback
	Prints (An icon will display when a printer is connected. See the <i>Direct Print User Guide</i> for details.)
	Play
	Slow Motion Playback (You can use the ← button to slow down or the → button to speed up playback.)
	Displays the first frame
	Previous Frame (Rewinds if the FUNC./SET button is held down.)
	Next Frame (Fast Forwards if the FUNC./SET button is held down.)
	Displays the last frame



- Use the television's controls to adjust the volume when playing a movie on a TV set (p. 146).
- The sound cannot be played in slow motion playback.

Rotating Images in the Display



Images can be rotated clockwise 90° or 270° in the display.



Original



90°





270°

1 Select [Rotate].

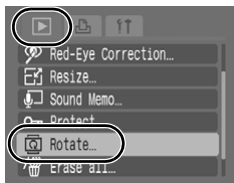
1. Press the  button.
2. In the [] menu, use the  or  button to select .
3. Press the  button.



2 Rotate the image.

1. Use the  or  button to select an image to rotate.
2. Press the  button.
 - Cycle through the 90°/270°/original orientations with each press of the **FUNC./SET** button.
 - This also can be set in the index playback mode.



When images are downloaded to a computer, the orientation of images rotated by the camera will depend upon the software used to download the images.

Playback with Transition Effects



You can select the transition effect displayed when switching between images.

	No transition effect.
	The displayed image darkens and the next image gradually brightens until it is displayed.
	Press the button to have the previous image display from the left and the button to have the next image display from the right.

1 Select [Transition].

1. Press the button.
2. In the [] menu, use the or button to select .



2 Accept the setting.

1. Use the or button to select , , or .
2. Press the button.

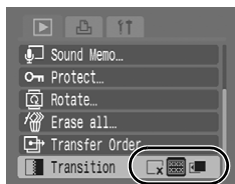





Automated Playback (Auto Play)



Use this feature to automatically play back all of the images in the memory card. The LCD monitor displays each image for approximately 3 seconds.

1 Select [Auto Play].

1. Press the  button.

2. In the [] menu, use the  or  button to select .

3. Press the  button.

- During automated playback, the following functions are possible:
 - Pausing/resuming the Auto Play: Press the **FUNC./SET** button
 - Fast forwarding/rewinding: Press the  or  button (holding down the button will increase the speed of the Fast Forward)
 - Stopping the Auto Play: Press the **MENU** button



If transition effects is selected (p. 128), the selected transition effects appear between images.

Red-Eye Correction Function



You can correct red eyes in recorded images.



Red eyes may not be automatically detected in some images or the results may not turn out as you intended.

Examples:



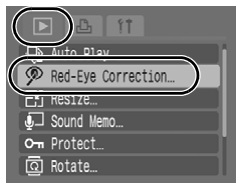

- Faces near the screen edges or faces that appear extremely small, large, dark or bright in relation to the overall image.
- Faces turned to the side or at a diagonal, or faces with a portion hidden.

1 Select [Red-Eye Correction].

1. Press the  button.
2. In the [] menu, use the  or  button to select .
3. Press the  button.



2 Select an image.

1. Use the  or  button to select the image you wish to correct red eyes.
2. Press the  button.
 - A frame will automatically display where a red eye is detected.
 - If red-eye is not automatically detected, select [Add Frame] with  or  button and press **FUNC./SET** button (p. 132).
 - To cancel the correction frame, select [Remove Frame] and press the **FUNC./SET** button (p. 133).



3 Correct the image.

1. Use the ◀ or ▶ button to select [Start].
2. Press the  button.





4 Save the image.

1. Use the ◀ or ▶ button to select [New File] or [Overwrite].
2. Press the  button.

- [New File]: Saved as new file with a new name. The uncorrected image is stored. The new image is stored as the last file.
- [Overwrite]: Saved with the same file name as the uncorrected image. The uncorrected image is erased.
- When [New File] is selected, proceed to the step 5.



5 Display the saved image.

1. Press the  button.
 2. Use the ◀ or ▶ button to select [Yes].
 3. Press the  button.
- Selecting [No] returns to the Play menu.



- Red-eye correction cannot be performed on movies.
- Overwriting cannot be performed on protected images.



- When there is not enough space left on the memory card, red-eye correction cannot be performed.
- Although you can apply red eye correction any number of times to an image, the image quality will gradually deteriorate with each application.
- Since the correction frame will not appear automatically on images that have already been corrected once with the (Red-Eye Correction) function, use the [Add Frame] option to correct them.

Add Correction Frame

1 Select [Add Frame].

1. Use the **←** or **→** button to select [Add Frame].
2. Press the  button.
 - A green frame will display.



2 Adjust the position of the frame.

1. Use the **↑**, **↓**, **←** or **→** button to move the frame.
- Size of the frame can be changed with the zoom lever.



3 Add a correction frame.

1. Press the  button.
 - The correction frame will be added and the frame color will change to white.
 - Press the **FUNC./SET** button to add additional frames.
 - Up to 35 frames may be added.
 - Press the **MENU** button to finish adding correction frames.



To correctly perform red-eye correction, take note of the following (refer to the image in step 2 on page 132):

- Adjust the correction frame size so that it only surrounds the red-eye portion to be corrected.
- When there are several subjects with red-eye, be sure to add one correction frame per subject.

Removing Correction Frames

1 Select [Remove Frame].

1. Use the ◀ or ▶ button to select [Remove Frame].
2. Press the  button.



2 Adjust the position of the frame.

1. Use the ◀ or ▶ button to select a frame to remove.
 - The selected frame will appear in green.



3 Delete the frame.

1. Press the  button.
 - The selected frame will disappear.
 - To continue deleting frames, return to Step 2.
 - When you finish deleting frames, press the **MENU** button.

Resizing Images



You can resave images that were recorded at high recording pixel settings at lower settings.

M3	1600 x 1200 pixels
S	640 x 480 pixels
XS	320 x 240 pixels

1 Select [Resize].

1. Press the button.
2. In the [] menu, use the or button to select .
3. Press the button.

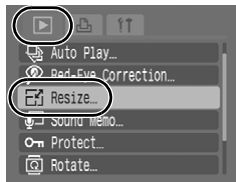

2 Select an image.

1. Use the or button to select an image to resize.
2. Press the button.
 - The **FUNC./SET** button is not selectable for images that cannot be resized.



3 Select the recording pixels.

1. Use the or button to select **M3**, **S** or **XS**.
2. Press the button.
 - Some recording pixel settings cannot be selected depending on the available space of the memory card.



4 Save the image.

1. Use the **←** or **→** button to select [OK].
2. Press the **FUNC. SET** button.
 - The resized image will be saved in a new file.



5 Display the saved image.

1. Press the **MENU** button.
2. Use the **←** or **→** button to select [Yes].
3. Press the **FUNC. SET** button.
 - Selecting [No] returns to the Play menu.

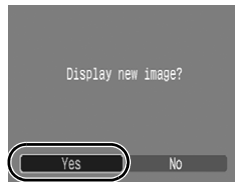

Movies and images shot in Widescreen mode cannot be resized.

Attaching Sound Memos to Images



In playback mode, you can attach sound memos (up to 1 min.) to an image. The sound data is saved in the WAVE format.

1 Select [Sound Memo].

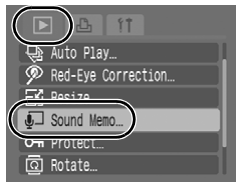
1. Press the  button.
2. In the [] menu, use the  or  button to select .
3. Press the  button.







2 Select an image.

1. Use the  or  button to select an image to which you wish to attach a sound memo.
2. Press the  button.
 - The sound memo control panel will display.



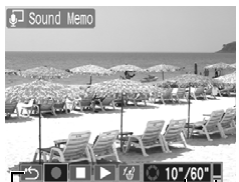

3 Record the memo.

1. Use the  or  button to select .
2. Press the  button.
 - The elapsed time and the remaining time display.
 - Pressing the **FUNC./SET** button pauses the recording. Pressing it again resumes recording.
 - Up to 1 minute of recordings can be added to any one image.
 - Press the **MENU** button several times to complete the setting. The screen will return to the Play menu.







Sound Memo Panel

Elapsed Time/
Remaining Time

Volume _____
(Adjust it with the  or  button)

Sound Memo Panel

Use the ◀ or ▶ button to select an option and press **FUNC./SET**

	Exit
	Record
	Pause
	Play
	Erase Select [Erase] in the confirmation screen and press the FUNC./SET button.



- You cannot attach sound memos to movies.
- Sound memos for protected images cannot be erased.

Protecting Images



You can protect important images and movies from accidental erasure.

1 Select [Protect].

1. Press the  button.
2. In the [] menu, use the ▲ or ▼ button to select .
3. Press the  button.



2 Protect the image.

1. Use the ◀ or ▶ button to select an image to protect.
2. Press the  button.
 - Pressing the **FUNC./SET** button again cancels the setting.
 - You can also protect images in the index playback mode.
 - Press the **MENU** button several times to complete the setting. The screen will return to the Play menu.



Protection Icon

Erasing All Images





- Note that erased images cannot be recovered. Exercise adequate caution before erasing an image.
- Protected images cannot be erased with this function.

1 Select [Erase all].

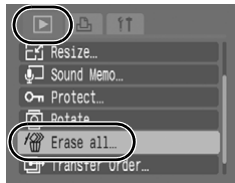
1. Press the  button.
2. In the [] menu, use the  or  button to select .
3. Press the  button.



2 Erase the images.

1. Use the  or  button to select [OK].
2. Press the  button.
 - To exit instead of erasing, select [Cancel].
 - Press the **MENU** button several times to complete the setting. The screen will return to the Play menu.

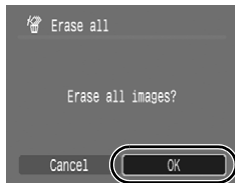

Please format the memory card when you want to erase not only image data but also all the data contained on the memory card (p. 56).

Print Settings/Transfer Settings









Setting the DPOF Print Settings

You can select images on a memory card for printing and specify the number of print copies in advance using the camera. The settings used on the camera comply with the Digital Print Order Format (DPOF) standards. This is extremely convenient for printing on a direct print compatible printer, or for sending the images to a photo developing service that supports DPOF.

The  icon may display for a memory card with print settings set by a different DPOF-compliant camera. These settings will be overwritten by those set by your camera.

Single Images

1 Select [Select Images & Qty.].

1. Set the mode switch to .
2. Press the  button.
3. Use the  or  button to select the  menu.
4. Use the  or  button to select [Select Images & Qty.].
5. Press the  button.

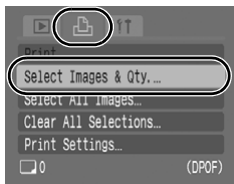



- Selecting [Clear All Selections] cancels all print settings.



2 Select the images.



- Selection methods differ for the Print Type settings (p. 142).

Standard ()/Both ()

1. Use the  or  button to select the images.

2. Press the  button.

3. Use the  or  button to select the number of print copies (up to 99).

- When the camera is connected to a printer, the  button will light in blue while images are being selected. At this time, press the  button, confirm that [Print] is selected, and when the **FUNC./SET** button is pressed, printing will begin.

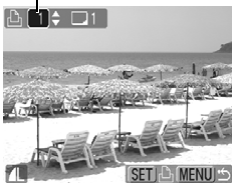

Number of Print Copies



4. Press the  button.

Index ()

1. Select and deselect with .

- When the camera is connected to a printer, the  button will light in blue while images are being selected. At this time, press the  button, confirm that [Print] is selected, and when the **FUNC./SET** button is pressed, printing will begin.

Index Print Selection

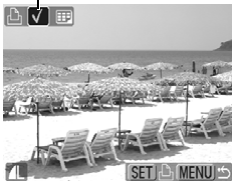









2. Press the  button.



- You can also select images in the index playback mode.

All the Images on a Memory Card

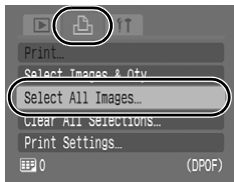

1 Select [Select All Images].

1. Set the mode switch to .
2. Press the  button.
3. Use the  or  button to select the  menu.
4. Use the  or  button to select [Select All Images].
5. Press the  button.



- One copy of every image will be set to print.
- When the camera is connected to a printer, the  button will light blue. At this time, press the  button, confirm that [Print] is selected, and when the **FUNC./SET** button is pressed, printing will begin.
- Selecting [Clear All Selections] cancels all print settings.

2 Select [OK].

1. Use the  or  button to select [OK].
2. Press the  button.

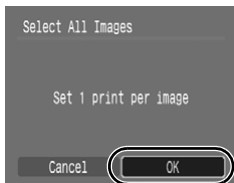

- The output of some printers or photo developing services may not reflect the specified print settings.
- Print settings cannot be set for movies.



- Images are printed in order according to the file number.
- A maximum of 998 images can be selected.
- When [Print Type] is set to [Both], the number of copies can be set. When it is set to [Index], the number of copies cannot be set (only one copy will be printed).









Setting the Print Style

After setting the print style, select the images for printing. The following settings can be selected.

* Default setting





Print Type	<input checked="" type="checkbox"/> Standard*	Prints one image per page.
	<input type="checkbox"/> Index	Prints the selected images together at a reduced size in an index format.
	<input checked="" type="checkbox"/> <input type="checkbox"/> Both	Prints the images in both the standard and index formats.
<input checked="" type="checkbox"/> Date (On/Off*)	Adds the date to the print.	
<input type="checkbox"/> File No. (On/Off*)	Adds the file number to the print.	
Clear DPOF data (On*/Off)		Clears all print settings after the images print.

1 Select [Print Settings].

1. Set the mode switch to .
2. Press the  button.
3. Use the  or  button to select the  menu.
4. Use the  or  button to select [Print Settings].
5. Press the  button.



2 Accept the setting.

1. Use the  or  button to select [Print Type], [Date], [File No.] or [Clear DPOF data].
2. Use the  or  button to select a setting to configure.
3. Press the  button.

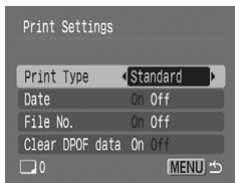



- The Date and File No. settings change according to the Print Type as follows.
 - Index
[Date] and [File No.] cannot be set to [On] at the same time.
 - Standard or Both
[Date] and [File No.] can be set to [On] at the same time, however, the printable information may vary between printers.
- Images dated using  (Postcard Date Imprint mode) (p. 71) are always printed with the date, regardless of the [Date] setting. As a result, some printers may print the date twice on these images if [Date] is also set to [On].
- Dates print in the style specified in the [Date/Time] menu (p. 12).

Setting the DPOF Transfer Settings







You can use the camera to specify settings for images before downloading to a computer. Refer to the *Software Starter Guide* for instructions on how to transfer images to your computer.

The settings used on the camera comply with the DPOF standards.

The  icon may display for a memory card with transfer settings set by a different DPOF-compliant camera. These settings will be overwritten by those set by your camera.



Single Images

1 Select [Transfer Order].

1. Set the mode switch to .
2. Press the  button.
3. In the [] menu, use the  or  button to select .
4. Press the  button.



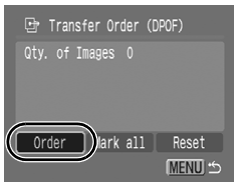

2 Select [Order].

1. Use the  or  button to select [Order].
2. Press the  button.
 - Selecting [Reset] cancels all transfer order settings.







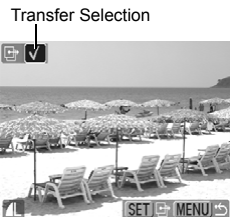

3 Select the images.

1. Use the  or  button to select images to transfer.
2. Press the  button.
 - Pressing the **FUNC./SET** button again deselects the setting.
 - You can also select images in the index playback mode.
 - Press the **MENU** button several times to complete the setting. The screen will return to the Play menu.





All the Images on a Memory Card

1 Select [Transfer Order].

1. Set the mode switch to .
2. Press the  button.
3. In the [] menu, use the  or  button to select .
4. Press the  button.





2 Select [Mark all].

1. Use the  or  button to select [Mark all].
 2. Press the  button.
- Selecting [Reset] cancels all transfer order settings.



3 Select [OK].

1. Use the  or  button to select [OK].
 2. Press the  button.
- Press the **MENU** button several times to complete the setting. The screen will return to the Play menu.

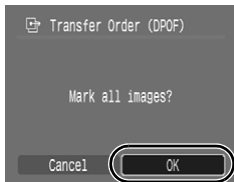

- Images are transferred in order according to the file number.
- A maximum of 998 images can be selected.

Connecting to a TV

Shooting/Playback Using a TV



You can use the supplied AV cable to shoot or playback images using a TV.

1 Turn off the camera and the TV.

2 Connect the AV cable to the camera's A/V OUT terminal.

- Open the terminal cover and plug the AV cable in all the way.

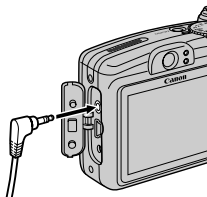

3 Plug the other ends of the AV cable to the VIDEO IN and AUDIO IN jacks on the TV.

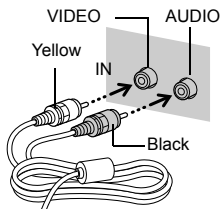

4 Turn on the TV and switch it to video mode.

5 Turn on the camera.



- The video output signal can be switched (NTSC or PAL) to accommodate different regional standards (p. 48). The default setting varies between regions.
 - NTSC: Japan, U.S.A., Canada, Taiwan and others
 - PAL: Europe, Asia (excluding Taiwan), Oceania and others
- If the video system is set incorrectly, the camera output may not display properly.

Troubleshooting

- Camera (p. 147)
- When the power is turned on (p. 148)
- LCD monitor (p. 148)
- Shooting (p. 150)
- Shooting movies (p. 154)
- Playback (p. 155)
- Battery (p. 156)
- TV monitor output (p. 156)
- Printing with a direct print compatible printer (p. 157)

Camera

Camera will not operate.

Power is not turned on.	● Press the power button (p. 14).
Memory card slot/battery cover is open.	● Confirm that the cover is securely closed (p. 8).
Batteries are loaded in the wrong direction.	● Reload the batteries in the correct direction (p. 9).
Batteries are not the right type.	● Use only unused AA-size alkaline batteries or Canon AA-size NiMH batteries (p. 168).
Battery charge is low and the camera will not operate. ("Change the batteries" message displays).	<ul style="list-style-type: none"> ● Replace the camera batteries with 2 unused or fully charged batteries (p. 168). ● Use the AC Adapter Kit ACK800 (sold separately) (p. 174).
Poor contact between camera and battery terminals.	<ul style="list-style-type: none"> ● Wipe the battery terminals with a clean dry cloth. ● Reload the batteries several times.

Sounds come from the camera interior.

The camera's horizontal/vertical orientation was changed.

- The camera's orientation mechanism is operating. There is no malfunction.

When the power is turned on**“Card locked!” message appears.**

The SD memory card's or SDHC memory card's write protect tab is set to “Write protect”.

- When recording to, erasing from or formatting the memory card, slide the write protect tab upward (p. 170).

The Date/Time menu appears.

The lithium date/time battery charge is depleted.

- Replace the lithium date/time battery (p. 182).

LCD monitor**Not displayed.**

LCD monitor is set to Off.

- Press **DISP.** button and turn on the LCD monitor (p. 49).

The display darkens.

The image in the LCD monitor will darken in strong sunlight or bright light.

- This is a normal occurrence in devices containing CCDs and does not constitute a malfunction. This image will not be recorded when shooting still photos, but it will be recorded when shooting movies.

Display flickers.

Display flickers when shot under fluorescent lighting.

- This is not a camera malfunction (flickering recorded in movies, but not in still images).

A bar of light (purplish red) appears on the LCD monitor.

Sometimes appears when shooting a bright subject, such as the sun or other light source.

- This is a normal occurrence in devices containing CCDs and does not constitute a malfunction. This bar of light will not be recorded when shooting still photos, but it will be recorded when shooting movies.

appears.

A slow shutter speed has likely been selected because of insufficient lighting.

- Set the IS Mode to any setting other than [Off] (p. 68).
- Raise the ISO speed (p. 100).
- Select a setting other than  (flash off) (p. 64).
- Set the self-timer and attach the camera to a tripod or other device (p. 66).

appears.

This displays when using a memory card that has print settings or transfer settings set by other DPOF-compliant cameras.

- These settings will be overwritten by those set by your camera (pp. 139, 144).

Noise displays./Subject's movements are irregular.

Camera automatically lightened the image displayed on the LCD monitor to make it easier to see when shooting in a dark area (p. 49).

- There is no effect on the recorded image.

Shooting

Camera will not record.



Mode switch is set to  (playback).	<ul style="list-style-type: none"> ● Set the mode switch to  (shooting) (p. 14).
Flash is charging.	<ul style="list-style-type: none"> ● When the flash is charged, the indicator will light orange. Shooting is now possible (p. 41).
Memory card is full.	<ul style="list-style-type: none"> ● Insert a new memory card (p. 10). ● If required, download the images to a computer and erase them from the memory card to make space.
Memory card is not formatted correctly.	<ul style="list-style-type: none"> ● Format the memory card (p. 56). ● If reformatting does not work, the memory card logic circuits may be damaged. Consult the nearest Canon Customer Support Help Desk.
SD memory card or SDHC memory card is write protected.	<ul style="list-style-type: none"> ● Slide the write protect tab upward (p. 170).

Image Seen in viewfinder vs. recorded image

Usually the recorded image contains more of the scene than is seen in the viewfinder.	<ul style="list-style-type: none"> ● Confirm the actual image size with the LCD monitor. Use the LCD monitor when taking close-up shots (p. 65).
---	---

Image is blurred or out of focus.

The camera moves when the shutter button is pressed.	<ul style="list-style-type: none"> ● Confirm the procedures in “ appears” (p. 149).
--	---

AF-assist Beam is set to [Off].	<ul style="list-style-type: none"> ● In dark places where it is difficult for the camera to focus, the AF-assist Beam will emit to assist focusing. As the AF-assist Beam will not function when turned off, set it [On] to activate it (p. 45). Take care not to obstruct the AF-assist Beam with your hand when used.
Subject is out of focal range.	<ul style="list-style-type: none"> ● Shoot with the subject at the correct focusing distance (p. 185). ● The camera may be set to an unintended function (such as Macro or Manual Focus mode). Cancel the setting.
The subject is hard to focus on.	<ul style="list-style-type: none"> ● Use the focus lock, AF lock or manual focus to shoot (p. 94).

Subject in recorded image is too dark.

Insufficient light for shooting.	<ul style="list-style-type: none"> ● Set the flash to  (Flash on) (p. 64).
The subject is underexposed because the surroundings are too bright.	<ul style="list-style-type: none"> ● Set the exposure compensation to a positive (+) setting (p. 101). ● Use the AE Lock or spot metering functions (pp. 98, 102).
Subject is too far away for flash to reach.	<ul style="list-style-type: none"> ● Shoot with the subject within the correct flash range when using the built-in flash (p. 186). ● Raise the ISO speed and then shoot (p. 100).

Subject in recorded image is too bright, or image flashes white.

Subject is too close, making the flash too strong.	<ul style="list-style-type: none"> ● Shoot with the subject within the correct flash range when using the built-in flash (p. 186). ● Set the Safety FE to [On] (p. 113).
The subject is overexposed because the surroundings are too dark.	<ul style="list-style-type: none"> ● Set the exposure compensation to a negative (-) setting (p. 101). ● Use the AE Lock or spot metering functions (pp. 98, 102).

Too much light is shining directly into the camera, or is being reflected off the subject.







- Change the shooting angle.

Flash is set to on.

- Set the flash to  (Flash off) (p. 64).

Image contains noise.

ISO speed is too high.

- Higher ISO speeds and  (High ISO Auto) setting may increase image noise. For higher image quality, use as low an ISO speed as possible (p. 100).
- In , ,  and ,  modes in the **SCN** mode, the ISO speed increases and noise can appear.

White dots appear on the image.

Light from the flash has reflected off dust particles or insects in the air. This is particularly noticeable when shooting using the wide angle or when you increase the aperture value in the aperture-priority Av mode.

- This is a phenomenon that occurs with digital cameras and does not constitute a malfunction.

Eyes appear red.

Light is reflected back from the eyes when the flash is used in dark areas.

- In the Rec. menu set the Red-Eye setting to [On] (p. 88). For this mode to be effective, the subject must be looking right at the red-eye reduction lamp. Try asking them to look directly at the lamp.
Even better results can be obtained by increasing the lighting in indoor settings or approaching closer to the subject. The shutter will not activate for approximately 1 second after the red-eye reduction lamp fires in order to improve the effect.
- You can correct red eyes in images using the Red-Eye Correction function (p. 130).

Continuous shooting slows down.

The memory card's performance has dropped.

- To enhance the continuous shooting performance, you are recommended to format the memory card in the camera after you save all its images to your computer (p. 56).

Recording images to memory card takes a long time.

Memory card was formatted in another device.

- Use a memory card formatted in your camera (p. 56).

Lens will not retract.

Memory card slot/battery cover was opened with power on.

- After closing the memory card slot/battery cover, turn the power on then back off.

Shooting movies

The recording time may not display properly or shooting may stop unexpectedly.

The following types of memory cards are used.

- Slow recording cards.
- Cards formatted on a different camera or a computer.
- Cards which have had images recorded and erased repeatedly.

- Although the recording time may not display properly during shooting, the movie will be recorded correctly on the memory card. Recording time will display properly if you format the memory card in this camera (excluding slow recording memory cards) (p. 56).

“!” displayed on the LCD monitor in red and shooting automatically stopped.

There is insufficient free space in the camera's built-in memory.

- Try the following procedures.
 - Format the card with a low level format before shooting (p. 56)
 - Lower the recording pixels (p. 81)
 - Use a high-speed memory card (SDC-512MSH, etc.)

Zoom does not operate.

Zoom lever was pressed while shooting in movie mode.

- Operate the zoom before shooting in movie mode (p. 59). Note the digital zoom is available while shooting, but only in Standard movie mode.

Playback

Cannot play back.

You attempted to play back images shot with another camera or images edited with a computer.

- Computer images that cannot be played back may play back if they are added to the camera using the supplied software program ZoomBrowser EX or ImageBrowser. See *ZoomBrowser EX/ImageBrowser Software User Guide* (PDF).

File name was changed with a computer or file location was changed.

- Set the file name or location on the file format/structure of the camera. (Refer to the *Software Starter Guide* for details).

Movies do not play back correctly.

Movies recorded with high recording pixels may momentarily stop playing if played on slow reading memory cards.

You may experience frame dropping and audio breakup when playing back a movie on a computer with insufficient system resources.

Reading images from memory card is slow.

Memory card was formatted in another device.

- Use a memory card formatted in your camera (p. 56).

Battery

Batteries consumed quickly.

Batteries are not the right type.	<ul style="list-style-type: none"> ● Use only unused AA-size alkaline batteries or Canon AA-size NiMH batteries (p. 168).
Battery capacity drops due to low ambient temperatures.	<ul style="list-style-type: none"> ● If shooting in a cold location, warm the batteries such as by placing them in your pocket before using them.
Battery terminals are dirty.	<ul style="list-style-type: none"> ● Wipe the terminals well with a dry cloth before use. ● Reload the batteries several times.

If using Canon AA-size NiMH batteries

As the batteries have not been used for over a year, their recharging capacity has decreased.	<ul style="list-style-type: none"> ● Their charging performance should return to normal after fully recharging and fully depleting them over several times.
Battery life has been exceeded.	<ul style="list-style-type: none"> ● Replace both batteries with new ones.

TV monitor output

Image is distorted or not showing on TV monitor.

Incorrect video system setting.	<ul style="list-style-type: none"> ● Set the video system to the appropriate setting, NTSC or PAL, for your TV (p. 48).
Shooting in Stitch Assist mode.	<ul style="list-style-type: none"> ● The output will not appear on a TV in Stitch Assist mode. Shoot in a different shooting mode (p. 73).

Printing with a direct print compatible printer

Cannot print

The camera and printer are not properly connected.	● Securely connect the camera and printer with the specified cable.
The printer power is not turned on.	● Turn on the printer power.
The print connection method is not correct.	● In the [ii] menu, select [Print Method] and select [Auto] (p. 48).

List of Messages

The following messages may appear on the LCD monitor during shooting or playback. Please refer to the *Direct Print User Guide* for the messages that display during a printer connection.

Busy...

Image is being recorded to the memory card, or the playback mode is starting up.

No memory card

You turned on the camera without a memory card installed, or with a memory card installed in the wrong orientation (p. 10).

Card locked!

The SD memory card or SDHC memory card is write-protected (p. 170).

Cannot record!

You attempted to shoot an image without a memory card installed, with a memory card installed in the wrong orientation, or attempted to attach a sound memo to a movie.

Memory card error

There may be something wrong with the memory card. By formatting the malfunctioning memory card with the camera, you may be able to continue using it. However, if this error message appears even when using the supplied memory card, contact your Canon Customer Support Help Desk as there may be a problem with the camera.

Memory card full

Memory card is full of images and no more can be recorded or saved, or no more image settings, sound recorder files or sound memos can be recorded.

Naming error!

The file name could not be created because there is an image with the same name as the folder that the camera is attempting to create, or the highest possible file number has already been reached. In the Set up menu, set [File Numbering] to [Auto Reset]; alternatively, save all the images you wish to retain onto a computer, then reformat the memory card. Please note that formatting will erase all the existing images and other data.

Change the batteries

Battery charge is insufficient to operate the camera. Replace both batteries immediately with unused AA-size alkaline batteries or fully charged Canon AA-size NiMH batteries.

No image.

No images recorded on memory card.

Image too large.

You attempted to play back an image larger than 5616 x 3744 pixels or with a large data size.

Incompatible JPEG

You attempted to play back an incompatible JPEG image (edited with a computer, etc.).

RAW

You attempted to play back an incompatible RAW image.

Unidentified Image

You attempted to play back an image with corrupted data, an image with a recording type specific to another manufacturer's camera, or an image that has been downloaded to a computer and altered.

Cannot magnify!

You attempted to magnify an image recorded in a different camera or data type, an image edited with a computer, or a movie.

Cannot rotate

You attempted to rotate the image shot with a different camera or data type, or an image edited with a computer.

Incompatible WAVE

A sound memo cannot be added to this image since the data type of the existing sound memo is incorrect. In addition, sound cannot be played back.

Cannot modify image

You attempted to resize or perform red eye correction on a movie or an image recorded with another camera. Or you attempted to resize an image recorded using **[W]**, or already resized to **[XS]**.

Cannot Modify

Cannot apply red-eye correction as no red-eye is detected.

Cannot transfer!

When transferring images to your computer using the Direct Transfer menu, you attempted to select an image with corrupted data or an image taken with another camera. You may have also attempted to select a movie when [Wallpaper] was selected in the Direct Transfer menu.

Protected!

You attempted to erase a protected image, movie or sound memo.

Too many marks.

Too many images have been marked with print settings or transfer settings. Cannot process any more.

Cannot complete!

Could not save a part of the print or transfer settings.

Unselectable image.

You attempted to set the print settings for a non-JPEG image.

Communication error

The computer was unable to download the image due to the large amount of images (approx. 1000) stored on the memory card. Use a USB card reader or a PCMCIA card adapter to download the images.

Lens error, restart camera

An error was detected while the lens was in motion, and the power has been automatically turned off. This error can occur if you hold the lens while it is in motion or you operate it in a location with excessive dust or sand in the air. Try turning the power back on, and resume shooting or playback. If this message continues to display, contact your Canon Customer Support Help Desk as there may be a problem with the lens.

Exx

(xx: number) Camera detected error. Turn the power off and then back on, then shoot or play back. A problem exists if the error code reappears. Note the number and contact your Canon Customer Support Help Desk. If an error code displays directly after taking a picture, the shot may not have been recorded. Check image in playback mode.

Appendix

Safety Precautions

- Before using the camera, please ensure that you read the safety precautions described below and in the “Safety Precautions” section. Always ensure that the camera is operated correctly.
- The safety precautions noted on the following pages are intended to instruct you in the safe and correct operation of the camera and its accessories to prevent injuries or damage to yourself, other persons and equipment.
- Equipment refers to the camera, battery, battery charger (sold separately) and compact power adapter (sold separately).

Warnings

Equipment

- **Do not point the camera directly at the sun or bright light sources.**

Doing so could damage the camera's CCD or your eyesight.

- **Store this equipment out of the reach of children and infants. Accidental damage by a child could result in serious injury.**

- Wrist strap: Placement of the strap around the child's neck could result in asphyxiation.
- Memory card: It may be swallowed accidentally. If this occurs, contact a doctor immediately.

- **Do not attempt to disassemble or alter any part of the equipment that is not expressly described in this guide.**
- **To avoid the risk of high-voltage electrical shock, do not touch the flash portion of the camera if it has been damaged.**
- **Stop operating the equipment immediately if it emits smoke or noxious fumes.**
- **Do not allow the equipment to come into contact with, or become immersed in, water or other liquids. If the exterior comes into contact with liquids or salt air, wipe it dry with a soft, absorbent cloth.**

Continued use of the equipment may result in fire or electrical shock. Immediately turn the camera power off and remove the camera batteries or unplug the battery charger or compact power adapter from the power outlet. Please consult your camera distributor or the closest Canon Customer Support Help Desk.

Equipment

- **Do not use substances containing alcohol, benzene, thinners or other flammable substances to clean or maintain the equipment.**
- **Do not cut, damage, alter or place heavy items on the power cord.**
- **Use only recommended power accessories.**
- **Remove the power cord on a regular periodic basis and wipe away the dust and dirt that collects on the plug, the exterior of the power outlet and the surrounding area.**
- **Do not handle the power cord if your hands are wet.**

Continued use of the equipment may result in fire or electrical shock.

Battery

- **Do not place the batteries near a heat source or expose it to direct flame or heat.**
- **The batteries should not be immersed in water or sea water.**
- **Do not attempt to disassemble, alter or apply heat to the batteries.**
- **Avoid dropping or subjecting the batteries to severe impacts that could damage the casing.**
- **Use only recommended batteries and accessories.**

Failure to follow these precautions may cause explosions or leaks, resulting in fire, injury and damage to the surroundings. In the event that a battery leaks and the eyes, mouth, skin or clothing contact these substances, immediately flush with water and seek medical assistance.

- **Disconnect the battery charger and compact power adapter from both the camera and the power outlet after recharging or when not in use to avoid fire and other hazards.**
- **Do not place anything, such as tablecloths, carpets, bedding or cushions, on top of the battery charger while it is charging.**
Leaving the units plugged in for a long period of time may cause them to overheat and distort, resulting in fire.

Battery

- **When recharging the Canon AA-size NiMH batteries, use only a specified battery charger.**
- **The compact power adapter is designed for exclusive use with this equipment. Do not use it with other products.**
There is a risk of overheating and distortion which could result in fire or electrical shock.
- **Before you discard a battery, cover the terminals with tape or other insulators to prevent direct contact with other objects.**
Contact with the metallic components of other materials in waste containers may lead to fire or explosions.

Others

- **Do not trigger the flash in close proximity to human or animal eyes. Exposure to the intense light produced by the flash may damage eyesight.**
In particular, remain at least one meter (39 inches) away from infants when using the flash.
- **Keep objects that are sensitive to magnetic fields (such as credit cards) away from the speaker of the camera.**
Such items may lose data or stop working.
- **Exercise due caution when screwing on the separately sold wide converter, tele-converter, close-up lens and conversion lens adapter.**
If they loosen, fall off and shatter, the glass shards may cause injury.

Cautions

Equipment

- **Be careful not to bang the camera or subject it to strong impacts or shocks that could lead to injury or damage the equipment when wearing or holding it by the strap.**
- **Do not store the equipment in humid or dusty areas.**
- **Do not allow metal objects (such as pins or keys) or dirt to contact the charger terminals or plug.**
Such conditions could lead to fire, electrical shock or other damage.
- **Avoid using, placing or storing the equipment in places subject to strong sunlight or high temperatures, such as the dashboard or trunk (boot) of a car.**
- **Do not use the equipment in a manner that exceeds the rated capacity of the electrical outlet or wiring accessories. Or, do not use the equipment if the cable or plug is damaged, or if the plug is not fully inserted into the power outlet.**
- **Do not use in locations with poor ventilation.**
The above-mentioned can cause leakage, overheating or explosion, resulting in fire, burns or other injuries. High temperatures may also cause deformation of the casing.
- **When not using the camera for extended periods of time, remove the batteries from the camera or battery charger and store the equipment in a safe place.**
If the batteries are left inside the camera, damage caused by leakage may occur.
- **Do not connect compact power adapters or battery chargers to devices such as electrical transformers for foreign travel because it may lead to malfunctions, excessive heat generation, fire, electric shock or injury.**

Flash

- **Do not operate the flash with dirt, dust or other items stuck to the surface of the flash.**
- **Be careful not to cover the flash with your fingers or clothing when shooting.**
The flash may be damaged and emit smoke or noise. The resulting heat build-up could damage the flash.
- **Do not touch the surface of the flash after taking several pictures in rapid succession.**
Doing so could result in burns.

Preventing Malfunctions

Avoid Strong Magnetic Fields

- **Never place the camera in close proximity to electric motors or other equipment generating strong electromagnetic fields.**
Exposure to strong magnetic fields may cause malfunctions or corrupt image data.

Avoid Condensation Related Problems

- **When moving the equipment rapidly from cold to hot temperatures, you can avoid condensation by placing the equipment in an airtight, resealable plastic bag and letting it adjust to temperature changes slowly before removing it from the bag.**
Moving the equipment rapidly from cold to hot temperatures may cause condensation (water droplets) to form on its external and internal surfaces.

If Condensation Forms Inside the Camera

- **Stop using the camera immediately.**
Continued use may damage the equipment. Remove the memory card and batteries or compact power adapter from the camera and wait until the moisture evaporates completely before resuming use.

Battery Handling

Battery Charge

The following icon and message will display.



Battery charge is low. If using the camera for an extended period, replace the batteries as soon as possible.

Change the batteries

Batteries are fully depleted and the camera can no longer operate. Replace the batteries immediately.

Battery Handling Precautions

- **This camera uses AA-size alkaline batteries or Canon AA-size NiMH batteries (sold separately).**
While it is possible to use AA-size nickel-cadmium batteries, performance is unreliable and their use is not recommended.
- **Since the performance of alkaline batteries may differ according to brand, the operating time of the batteries you purchase may not be as long as the batteries that came with the camera.**
- **When using the camera under low temperature conditions or over long periods, you are recommend to use of Canon AA-size NiMH batteries (sold separately).**
Camera operating time may shorten at low temperatures when alkaline batteries are used. Also due to their specifications, alkaline batteries may expire faster than NiMH batteries.
- **Never mix unused and partially used batteries.**
The partially used batteries may leak.
- **Do not install the batteries with their terminals (⊕ and ⊖) reversed.**
- **Do not mix batteries of different types or from different manufacturers.**

- **Before installing the batteries, wipe the battery terminals well with a dry cloth.**

If the battery terminals are soiled with oil from one's skin or other dirt, the number of recordable images may be considerably diminished, or the amount of time the camera can be used may be reduced.

- **At low temperatures, battery performance may be reduced and the low battery icon () may appear earlier than usual.**

Under these conditions, restore the battery performance by warming it in a pocket immediately before use.

- **Do not put the batteries into a pocket together with metallic items such as a key ring.**

The batteries may be short circuited.

- **When not using the camera for long periods, remove the batteries from the camera and store them separately.**

If the batteries are left inside the camera, the camera may become damaged from battery leakage.

WARNING

Never use damaged batteries or batteries whose outer seal is completely or partially missing or peeled off, as there is risk that such batteries may leak, overheat, or burst. Always check the seals on store-bought batteries before loading them, as some batteries may come with defective seals. Do not use batteries with defective seals.

Never use batteries that look like this.



Batteries with all or part of the seal (electrical insulation sheath) peeled off.



The positive electrode (plus terminal) is flat.



The negative terminal is correctly formed (protruding from the metal base), but the seal does not extend up over the edge of the metal base.

Handling the Memory Card

SD memory card or SDHC memory card Write Protect Tab

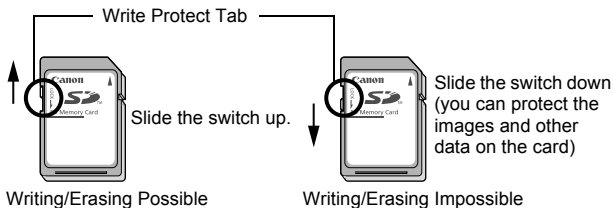

Cautions When Handling

- Memory cards are high-precision electronic devices. Do not bend them, apply force to them, or subject them to shocks or vibration.
- Do not attempt to disassemble or alter the memory card.
- Do not allow dirt, water or foreign objects to contact the terminals on the back of the card. Do not touch the terminals with your hands or metal objects.
- Do not peel away the original label on the memory card or cover it with another label or sticker.
- When writing on the memory card, do not use a pencil or ball-point pen. Only use a soft point pen (e.g. felt-tip pen).
- Do not use or store memory cards in the following locations.
 - Locations subject to dust or sand
 - Locations subject to high humidity and high temperatures
- Since some or all of the data recorded on the memory card may be corrupted or erased by electrical noise, static electricity, camera or card malfunction, making a backup copy of important data is recommended.

Formatting

- **Please note that formatting (initializing) an memory card erases all data, including protected images.**
- **You are recommended to use memory cards that have been formatted in your camera.**
 - The card supplied with the camera may be used without further formatting.
 - When the camera is malfunctioning, a corrupted memory card might be the cause. Reformatting the memory card may solve the problem.
 - When a non-Canon brand memory card is malfunctioning, reformatting it may solve the problem.
 - Memory cards formatted in other cameras, computers, or peripheral devices may not operate correctly in this camera. When that happens, reformat the memory card with this camera.
- **If formatting in the camera does not work properly, turn the camera off and re-insert the memory card. Then turn the camera back on and format again.**
- **Be careful when transferring or disposing of a memory card. Formatting or erasing the data on a memory card merely changes the file management information on the card and does not ensure that its contents are completely deleted. When disposing of a memory card, take precautions, such as physically destroying the card, to prevent personal information leaks.**

Using the Power Kits (Sold Separately)

Using Rechargeable Batteries (Battery and Charger Kit CBK4-300)

This kit includes a battery charger and four rechargeable AA-size NiMH (nickel metal hydride) batteries. Charge batteries as shown below. Recharging is also possible using two batteries.

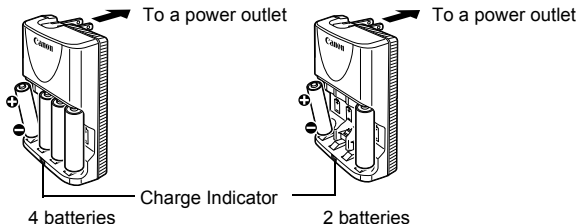

- After inserting the batteries, plug the charger (CB-5AH) into an outlet, or attach the power cord to the charger (CB-5AHE, not shown) and plug the other end into an outlet.
- Do not insert and charge additional batteries once charging has begun.
- The charge indicator blinks while charging, then remains lit when charging is finished.



- The CB-5AH/CB-5AHE battery charger can only be used to charge Canon AA-size NiMH batteries NB-3AH and NB-2AH. Please do not attempt to charge other type of battery.
- Do not mix batteries with different purchase dates or different charge states. When recharging batteries, always recharge both of them at the same time.
- Do not attempt to recharge fully charged batteries, as doing so may reduce or impair battery performance. Also, do not charge batteries for more than 24 consecutive hours.
- Do not recharge batteries in enclosed areas that tend to retain heat.
- Do not recharge the batteries until the LCD monitor displays the “Change the batteries” message. Repeatedly recharging batteries before they become fully depleted may cause batteries to lose capacity.



- Wipe the battery terminals well with a dry cloth in the following situations, as the terminals may be soiled with oil from one's skin or other dirt:
 - If the battery usage time has considerably diminished
 - If the number of recordable images has considerably diminished
 - When charging the batteries (insert and remove the batteries two or three times before charging)
 - When charging completes in a space of a few minutes (the battery charger indicator remains lit)
- You may not be able to fully charge the batteries due to their specifications right after purchase or after long periods of nonuse. If this happens, after fully charging them, use the batteries until their charge is depleted. After doing this several times, battery performance will be restored.
- If you store batteries for a long period of time (about 1 year), it is recommended that you fully deplete the batteries in the camera and to then store them at room temperature (0 to 30°C/32 to 90°F) in low humidity. Storing them in a fully charged condition can shorten their lifespan or degrade their performance.

Again, if you do not use batteries for more than 1 year, fully charge them once a year and deplete them in the camera before storing them.
- If the battery usage time has become considerably low despite wiping the terminals and charging them until the battery charger indicator remains lit, this may indicate that the batteries have reached the end of their lifespan. Replace them with new batteries. If you are purchasing new batteries, look for Canon AA-size NiMH batteries.
- Leaving batteries in the camera or charger may result in damage from battery leakage. When not in use, remove the batteries from the camera or charger and store them in a cool, dry location.



- It takes approximately 4 hours 40 minutes for the charger to fully recharge the batteries after they have been depleted. When two batteries are placed on each side of the charger, recharging will take approximately two hours (as determined by testing at Canon facilities). Charge batteries in an environment where the temperature is in the range of 0 to 35°C (32 to 95°F).
- The charging time varies according to the ambient temperature and to the battery charge state.
- The battery charger may emit noise while charging. This is not a malfunction.
- Battery/Charger Kit CBK4-200 can also be used.

Using the AC Adapter Kit ACK800

It is best to power the camera with AC Adapter Kit ACK800 (sold separately) when you are using it for long periods of time or connecting it to a computer.



Turn the camera power off before connecting or disconnecting the AC adapter.

1

Connect the power cord to the compact power adapter first and then plug the other end into the power outlet.

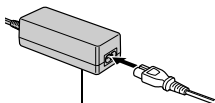

Compact Power Adapter CA-PS800

2

Open the terminal cover and attach the cord to the DC IN terminal.

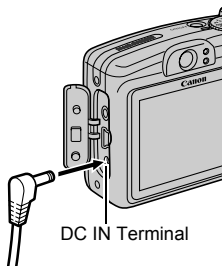

DC IN Terminal

Using the Lenses (Sold Separately)

The camera supports use of the separately sold Wide Converter WC-DC58N, Tele-converter TC-DC58N and Close-up lens 250D (58 mm). In order to attach these lenses, you also need to use the separately sold Conversion Lens Adapter LA-DC58G.



- When attaching the wide converter, tele-converter or close-up lens be sure to screw it on securely. If they come loose, they may fall from the lens adapter, posing risk of injury from shattered glass.
- Never look into the sun or into strong light through the wide converter, tele-converter or close-up lens as this can result in blindness or impairment of vision.



- If you use the flash when shooting with these attachments, the outer area of the recorded image (especially lower right corner) will come out relatively dark.
- When using the tele-converter, please set the focal length to the telephoto end. At other zoom settings, the image will appear as if its corners have been cut off.
- When using the wide converter, please set the camera to the wide angle end.
- If you use the viewfinder for shooting, a portion of the view will be blocked by these attachments. Please use the LCD monitor.

■ Wide Converter WC-DC58N

Use this converter for taking wide-angle shots. The wide converter changes the focal length of the camera body's lens by a factor of 0.7x (the thread diameter is 58 mm).

■ Tele-converter TC-DC58N

This lens is used for taking telephoto shots. The lens changes the focal length of the camera body's lens by a factor of 1.75x (the thread diameter is 58 mm).



It is not possible to attach a lens hood or filter to the wide converter or tele-converter.

■ Close-up lens 250D (58 mm)

This lens makes taking macro shots easy.

Focusing Range and Image Area

	Maximum wide angle		Maximum telephoto	
	Focusing range (from end of lens)	Image area at minimum focusing distance	Focusing range (from end of lens)	Image area at minimum focusing distance
Normal mode	18 - 25 cm (7.1 - 9.8 in.)	183 x 137 mm (7.2 - 5.4 in.)	18 - 25 cm (7.1 - 9.8 in.)	36 x 27 mm (1.4 - 1.1 in.)
Macro mode	0 - 17 cm (0 - 6.7 in.)	46 x 34 mm (1.8 - 1.3 in.)	—	—

■ Conversion Lens Adapter LA-DC58G

This is the lens adapter for attaching the wide converter, tele-converter and close-up lens to the camera. It can be divided into two: the front section and the rear section.

- **To Attach Wide Converter WC-DC58N or Tele-converter TC-DC58N**
Detach the front section of the conversion lens adapter and fit only the rear section to the camera.
- **To Attach Close-up Lens 250D**
Keep the two sections of the conversion lens adapter together to fit it to the camera.

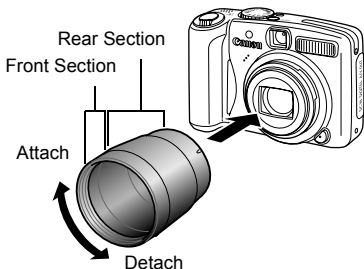

Attaching a Lens

1 Be sure that the camera is turned off.

2 Press the ring release button and hold it down (①), and turn the ring in the direction of the arrow (②).

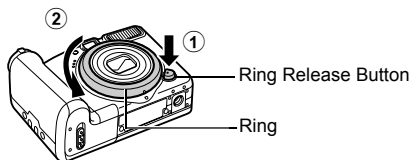

3 When the  mark on the camera and the  mark on the ring are aligned, lift off the ring.

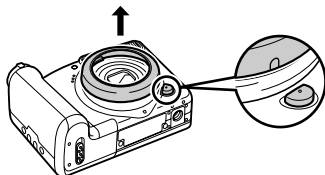

4 Detach the front section of the conversion lens adapter (p. 176).

- Keep the front and rear sections of the conversion lens adapter together to attach a close-up lens to the camera.

- 5 Align the ● mark on the conversion lens adapter with the ☺ mark on the camera, and turn the adapter in the direction of the arrows as far as the □ mark on the camera.**

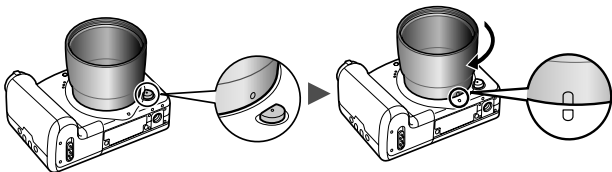

- To remove the conversion lens adapter, turn the adapter in the opposite direction with holding down the ring release button.

- 6 Set the lens on the adapter, and turn it in the indicated direction to attach it securely.**



- Completely remove all dust and dirt from conversion lenses with a lens blower brush before use. The camera may focus on any dirt that remains.
- Be careful when handling the lenses since it is easy to get finger prints on them.
- Be careful not to drop the camera or adapter when removing the ring.
- When using these lens attachments, you should not shoot images in  mode. It will not be possible to use the PhotoStitch software from your computer to accurately stitch the images together.

Converter Settings

Settings for when shooting using [IS Mode] (p. 68) with the separately sold Wide Converter WC-DC58N, Tele-converter TC-DC58N or Close-up lens 250D attached.



1 Set the mode switch to .

2 Select [Converter].

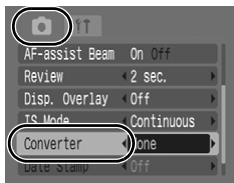
1. Press the  button.
2. In the [] menu, use the  or  button to select [Converter].



3 Accept the setting.

1. Use the  or  button to select [WC-DC58N], [TC-DC58N] or [250D].
2. Press the  button.
 - Select the attached converter.

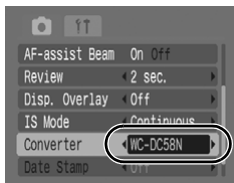

When you remove the converter from the camera, return the converter setting to [Off].

Using an Externally Mounted Flash (Sold Separately)

High-Power Flash HF-DC1

This flash is used to supplement the camera's built-in flash when the subject is too far away for proper illumination. Use the following procedures to affix the camera and High-Power Flash to the supporting bracket.

Please read the instructions accompanying the flash along with this explanation.

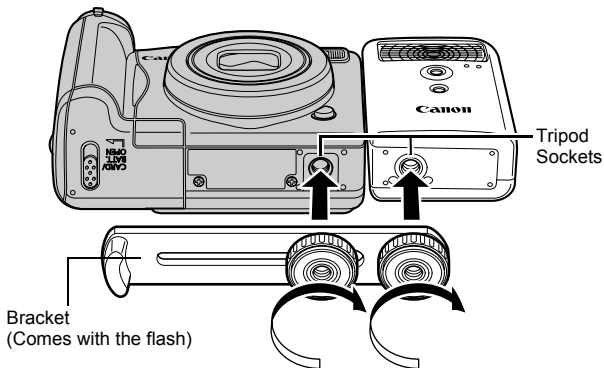

- The High-Power Flash will not fire in the following situations:
 - When shooting in **M** mode
 - When Flash Sync is set to [2nd-curtain]
 - When Flash Adjust is set to [Manual]
- The flash charge time will lengthen as the battery charge gets weaker. Always set the power/mode switch to [OFF] when you finish using the flash.
- Be careful not to touch the flash window or sensor windows with your fingers while the flash is in use.
- The flash may fire if another flash is being used in close proximity.
- The High-Power Flash may not fire outdoors in daylight or when there are no reflective items.

- For continuous shooting, although the flash fires for the first shot, it does not fire for subsequent shots.
- Fasten the attachment screws securely so that they do not loosen. Failure to do so may lead to the dropping of the camera and flash resulting in damage to both.



- Before attaching the bracket to the flash, check that the lithium battery (CR123A or DL123) is installed.
- To illuminate the subjects properly, install the flash so that it is up against the side of the camera and parallel with the camera's front panel.
- A tripod can be used even when the flash is attached.

■ Batteries

● Charge becomes Severely Limited

If the battery usage time has considerably diminished, wipe the battery terminals well with a dry cloth. The terminals may be dirty from fingerprints.

● Usage in Cold Temperatures

Get a spare generic lithium battery (CR123A or DL123). You are recommended to place the spare battery in your pocket to warm it up before switching it for the battery in the flash.

● Non-Use over Extended Periods

Leaving batteries in the High-Power Flash could allow the battery fluid to leak, damaging the product. Remove the batteries from the High-Power Flash and store them in a cool, dry place.

Replacing the Date Battery

If the Date/Time menu appears when the camera power is turned on, the date battery charge is low and the date and time settings have been lost. Please purchase a lithium coin battery (CR1220) and replace it as follows.

Please note that the first date battery may appear to expire relatively quickly after you purchase the camera. This is because it is installed in the camera at the point of manufacture, not when you make the purchase.



Be particularly careful to keep the date batteries out of the reach of children. Seek medical assistance immediately if a child swallows a battery since corrosive battery fluids can damage the stomach or intestinal walls.

- 1 Confirm that the camera is turned off.**
- 2 Slide the battery cover lock and open the cover (p. 8).**
- 3 Hook your nail onto the date battery holder and lightly pull it up.**



- 4 Remove the battery holder in the direction indicated by the arrow.**

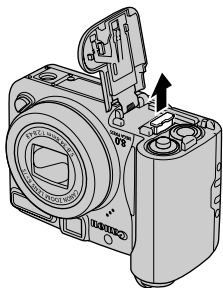

- 5 Remove the battery by pulling it up in the direction indicated by the arrow.**

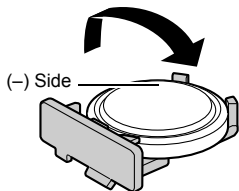

- 6 Insert a new battery with the (−) side facing up.**

- 7 Replace the battery holder and close the cover.**

- 8 When the Date/Time menu appears, set the date and time (p. 12).**



After purchasing the camera and turning on the power for the first time, although the Date/Time menu will appear, you do not need to replace the date battery.

If you ever dispose of your camera, first remove the date battery for recycling according to the recycling system of your country.

Camera Care and Maintenance

Never use thinners, benzine, detergents or water to clean the camera. These substances may distort or damage the equipment.

Camera Body

Gently wipe dirt off the camera body with a soft cloth or eyeglass lens wiper.

Lens

First use a lens blower brush to remove dust and dirt, then remove any remaining dirt by wiping the lens lightly with a soft cloth.



Never use organic solvents on the camera body or lens. If dirt remains, contact the closest Canon Customer Support Help Desk as listed on the customer support list supplied with your camera.

Viewfinder and LCD Monitor

Use a lens blower brush to remove dust and dirt. If necessary, gently wipe with a soft cloth or an eyeglass lens wiper to remove stubborn dirt.



Never rub or press strongly on the LCD monitor. These actions may damage it or lead to other problems.

Specifications

All data is based on Canon's standard testing methods. Subject to change without notice.

PowerShot A720 IS

(W): Max. wide angle (T): Max. telephoto

Camera Effective Pixels	: Approx. 8.0 million
Image Sensor	: 1/2.5-inch type CCD (Total number of pixels: Approx. 8.3 million)
Lens	: 5.8 (W) – 34.8 (T) mm (35mm film equivalent: 35 (W) – 210 (T) mm) f/2.8 (W) – f/4.8 (T)
Digital Zoom	: Approx. 4.0x (Up to approx. 24x in combination with the optical zoom)
Optical Viewfinder	: Real-image zoom viewfinder
LCD Monitor	: 2.5-inch type, amorphous silicon TFT color LCD, approx. 115,000 pixels (Picture coverage 100%)
AF System	: TTL autofocus AF lock and Manual focus are available Focusing frame: Face Detect/AiAF(9-point)/Center*/FlexiZone * Size of AF frame can be selected
Focusing Range	: Normal: 55 cm (1.8 ft.) – infinity Macro: 1 – 55 cm (W) (0.4 in. – 1.8 ft. (W)) Manual focus: 1 cm (0.4 in.) – infinity (W), 55 cm (1.8 ft.) – infinity (T) Kids&Pets: 1 m (3.3 ft.) – infinity
Shutter	: Mechanical shutter • electronic shutter
Shutter Speeds	: 15 – 1/2000 sec. • The shutter speed varies depending on the shooting mode. • Slow shutter speeds of 1.3 sec. or slower operate with noise reduction.
Image Stabilization	: Lens shift type Continuous/Shoot Only*/Panning*/Off * Still images only

Metering System	: Evaluative* ¹ , Center-weighted average or Spot* ² *1 When [AF Frame] is set to [Face Detect], the brightness of the face is also evaluated *2 Fixed to center/AF Point
Exposure Compensation	: ±2 stops in 1/3-stop increments
ISO speed (Standard Output Sensitivity, Recommended Exposure Index)	: Auto*, High ISO Auto*, ISO 80/100/200/400/ 800/1600 * Camera automatically sets the optimal speed.
White Balance	: Auto, Day Light, Cloudy, Tungsten, Fluorescent, Fluorescent H, Underwater or Custom
Built-in Flash	: Auto*, on*, off * Red-eye reduction is available. FE Lock/Slow Synchro/2nd-curtain/Flash output /Safety FE settings are available.
Compensation Range of Built-In Flash	: 30 cm – 3.5 m (1.0 – 11 ft.) (W), 55 cm – 2.5 m (1.8 – 8.2 ft.) (T) (ISO speed: Auto)
Flash Exposure Compensation	: ±2 stops in 1/3-stop increments
Shooting Modes	: Auto Creative zone: Program, Shutter-speed priority, Aperture priority, Manual Image zone: Portrait, Landscape, Night Snapshot, Kids&Pets, Indoor, Special Scene* ¹ , Stitch Assist and Movie* ² *1 Night Scene, Foliage, Snow, Beach, Fireworks, Aquarium and Underwater. *2 Standard and Compact.
Continuous Shooting	: Approx. 1.3 shots/sec. (Large/Fine mode)
Self-timer	: Activates shutter after an approx. 10-sec./ approx. 2-sec. delay, Custom Timer

Recording Media	: SD memory card/SDHC memory card/ MultiMediaCard/MMCplus memory card/HC MMCplus memory card	
File Format	: Design rule for camera file system and DPOF compliant	
Data Type (Still images)	: Exif 2.2 (JPEG)* Sound memos: WAVE (monaural)	
(Movies)	: AVI (Image data: Motion JPEG; Audio data: WAVE (monaural))	
	* This digital camera supports Exif 2.2 (also called "Exif Print"). Exif Print is a standard for enhancing the communication between digital cameras and printers. By connecting to an Exif Print-compliant printer, the camera's image data at the time of shooting is used and optimized, yielding extremely high quality prints.	
Compression	: Superfine, Fine, Normal	
Number of (Still images)	Large:	3264 x 2448 pixels
Recording	Medium 1:	2592 x 1944 pixels
Pixels	Medium 2:	2048 x 1536 pixels
	Medium 3:	1600 x 1200 pixels
	Small:	640 x 480 pixels
	Postcard:	1600 x 1200 pixels
	Widescreen:	3264 x 1832 pixels
(Movies)	: Standard:	
	640 x 480 pixels (30 frames/sec.)	
	640 x 480 pixels (30 frames/sec. LP)	
	320 x 240 pixels (30 frames/sec.)	
	Recording can continue until the memory card is full* ¹ (can record up to a maximum of 4 GB at one time)* ²	
	Compact: (can record for 3 min.)	
	160 x 120 pixels (15 frames/sec.)	
	* ¹ Using super high-speed memory cards (SDC-512 MSH recommended).	
	* ² Even if the clip size has not reached 4 GB, recording will stop at the moment the clip length reaches 1 hour. Depending on the volume and data writing speed of the memory card, recording may stop before reaching 1 hour or before the recorded data volume has reached 4 GB.	

Playback Modes	: Single (histogram displayable), Index (9 thumbnail images), Magnified (approx. 10x (max.) in LCD monitor, advance or reverse through magnified images possible), Jump (it is possible to jump to every tenth or hundredth image, to the first image of each shooting date, to movies or to the first image in each folder. In index playback mode, it displays 9 images at once.), Auto Play, Red-Eye Correction, Sound memos (up to 1 min.), Movie (slow motion playback possible) or Resize.
Direct Print	: <i>PictBridge</i> compliant, and <i>Canon Direct Print</i> and <i>Bubble Jet Direct</i> compatible
Interface	: USB 2.0 Hi-Speed (mini-B) Audio/Video output (NTSC or PAL selectable, monaural audio)
Communication Settings	MTP, PTP
Power Source	: 2 AA-size alkaline batteries 2 AA-size NiMH batteries NB4-300 (sold separately) AC Adapter Kit ACK800 (sold separately)
Operating Temperatures	: 0 – 40 °C (32 – 104 °F) (0 – 35 °C (32 – 95 °F) when NB-3AH is used.)
Operating Humidity	: 10 – 90%
Dimensions (excluding protrusions)	: 97.3 x 67.0 x 41.9 mm (3.83 x 2.64 x 1.65 in.)
Weight (camera body only)	: Approx. 200 g (7.05 oz.)

Battery Capacity

	Number of Images Shot		Playback Time
	LCD Monitor On (Based on the CIPA standard)	LCD Monitor Off	
AA-size Alkaline Batteries (included with the camera)	Approx. 140 images	Approx. 500 images	Approx. 9 hours
AA-size NiMH Batteries (NB-3AH (fully charged))	Approx. 400 images	Approx. 900 images	Approx. 11 hours

- The actual figures will vary according to the shooting conditions and settings.
- Movie data is excluded.
- At low temperatures, the battery performance may diminish and the low battery icon may appear very rapidly. In these circumstances, the performance can be improved by warming the battery in a pocket before use.

Test Conditions

Shooting: Normal temperature (23°C ±2°C/73°F ±3.6°F), normal relative humidity (50% ±20%), alternating wide angle end and telephoto end shots at 30 second intervals with the flash fired once every two shots and the camera power turned off after every tenth shot. Power is left off for a sufficient amount of time*, then the power is turned back on and the testing procedure is repeated.

- A Canon-brand memory card is used.

* Until the battery returns to normal temperature





















Playback: Normal temperature (23°C ±2°C/73°F ±3.6°F), normal relative humidity (50% ±20%), continuous playback at 3 seconds per image.



See *Battery Handling Precautions* (p. 168).

Memory Cards and Estimated Capacities







: Card included with the camera

Recording Pixels	Compression	16MB	SDC-128M	SDC-512MSH
L (Large) 3264 x 2448 pixels		3	35	139
		6	59	231
		13	123	479
M1 (Medium 1) 2592 x 1944 pixels		5	49	190
		9	87	339
		19	173	671
M2 (Medium 2) 2048 x 1536 pixels		8	76	295
		15	136	529
		30	269	1041
M3 (Medium 3) 1600 x 1200 pixels		13	121	471
		24	217	839
		47	411	1590
S (Small) 640 x 480 pixels		52	460	1777
		81	711	2747
		128	1118	4317
 (Post card) 1600 x 1200 pixels		24	217	839
W (Widescreen) 3264 x 1832 pixels		5	47	183
		8	79	307
		18	166	642

-  Capable of smooth continuous shooting (p. 87) when card has been formatted with a low level format.
- This reflects standard shooting criteria established by Canon. Actual results may vary according to the subject and shooting conditions.

Movie

□: Card included with the camera

	Recording Pixels /Frame Rate	16MB	SDC-128M	SDC-512MSH
 Standard	 640 x 480 pixels 30 frames/sec.	6 sec.	1 min. 4 sec.	4 min. 9 sec.
	 640 x 480 pixels 30 frames/sec. LP	14 sec.	2 min. 7 sec.	8 min. 14 sec.
	 320 x 240 pixels 30 frames/sec.	20 sec.	3 min. 1 sec.	11 min. 42 sec.
 Compact	 160 x 120 pixels 15 frames/sec.	1 min. 40 sec.	14 min. 29 sec.	55 min. 57 sec.











- Maximum movie clip length at : 3 min. The figures indicate the maximum continuous recording time.

Image Data Sizes (Estimated)

Recording Pixels	Compression		
			
L 3264 x 2448 pixels	3436 KB	2060 KB	980 KB
M1 2592 x 1944 pixels	2503 KB	1395 KB	695 KB
M2 2048 x 1536 pixels	1602 KB	893 KB	445 KB
M3 1600 x 1200 pixels	1002 KB	558 KB	278 KB
S 640 x 480 pixels	249 KB	150 KB	84 KB
 1600 x 1200 pixels	—	558 KB	—
W 3264 x 1832 pixels	2601 KB	1540 KB	736 KB

	Frame Rate/Recording Pixels		File size
 Standard		640 x 480 pixels, 30 frames/sec.	1920 KB/sec.
		640 x 480 pixels, 30 frames/sec. LP	960 KB/sec.
		320 x 240 pixels, 30 frames/sec.	660 KB/sec.
 Compact		160 x 120 pixels, 15 frames/sec.	120 KB/sec.

MultiMediaCard

Interface	Compatible with MultiMediaCard standards
Dimensions	32.0 x 24.0 x 1.4 mm (1.3 x 0.9 x 0.06 in.)
Weight	Approx. 1.5 g (0.05 oz.)

SD Memory Card

Interface	Compatible with SD memory card standards
Dimensions	32.0 x 24.0 x 2.1 mm (1.3 x 0.9 x 0.1 in.)
Weight	Approx. 2 g (0.07 oz.)

NiMH Battery NB-3AH

(Supplied with the separately sold NiMH Battery NB4-300 set or the Battery and Charger Kit CBK4-300)

Type	AA-size nickel metal hydride battery
Nominal Voltage	1.2 V DC
Typical Capacity	2500 mAh (min.: 2300 mAh)
Cycle Life	Approx. 300 times
Operating Temperatures	0 – 35 °C (32 – 95 °F)
Dimensions	Diameter: 14.5 mm (0.57 in.) Length: 50.0 mm (1.97 in.)
Weight	Approx. 30 g (1.06 oz.)

Battery Charger CB-5AH/CB-5AHE

(Supplied with the separately sold Battery and Charger Kit CBK4-300)

Rated Input	100 – 240 V AC (50/60 Hz)
Rated Output	565 mA* ¹ , 1275 mA* ²
Charging Time	Approx. 4 hours 40 min.* ¹ , Approx. 2 hours* ²
Operating Temperatures	0 – 35 °C (32 – 95 °F)
Dimensions	65.0 x 105.0 x 27.5 mm (2.56 x 4.13 x 1.08 in.)
Weight (body only)	Approx. 95 g (3.35 oz.)

*1 When charging four NB-3AH batteries

*2 When charging two NB-3AH batteries loaded one on each side of the battery charger

Compact Power Adapter CA-PS800

(Included with the separately sold AC Adapter Kit ACK800)

Rated Input	100 – 240 V AC (50/ 60 Hz)
Rated Output	3.15 V DC, 2.0 A
Operating Temperatures	0 – 40 °C (32 – 104 °F)
Dimensions	42.6 x 104.0 x 31.4 mm (1.68 x 4.09 x 1.24 in.)
Weight	Approx. 180 g (6.35 oz.) (excluding power cord)

Wide Converter WC-DC58N (Sold Separately)

Magnification	Approx. 0.7x
Focal Length* ¹	24.5 mm (35mm film equivalent)
Focusing Range* ¹	Approx. 25 cm (9.8 in.) – infinity (W)* ²
Thread Diameter	58 mm standard filter thread* ³
Dimensions	Diameter: 94.5 mm (3.7 in.) Length: 54.9 mm (2.2 in.)
Weight	Approx. 275 g (9.70 oz.)

Tele-converter TC-DC58N (Sold Separately)

Magnification	Approx. 1.75x
Focal Length*4	368 mm (35mm film equivalent)
Focusing Range**4	Approx. 1.8 m (5.9 ft.) – infinity (T)*2
Thread Diameter	58 mm standard filter thread*3
Dimensions	Diameter: 75.0 mm (3.0 in.) Length: 50.0 mm (2.0 in.)
Weight	Approx. 185 g (6.53 oz.)

Close-up Lens 250D 58 mm (Sold Separately)

Focusing Range (from front of lens)	18 – 25 cm (7.1 – 9.8 in.) (W/T)
Thread Diameter	58 mm standard filter thread*3
Dimensions	Diameter: 60.0 mm (2.36 in.) Length: 12.0 mm (0.47 in.)
Weight	Approx. 80 g (2.82 oz.)

Conversion Lens Adapter LA-DC58G (Sold Separately)

Thread Diameter	58 mm standard filter thread
Dimensions Diameter x Length	Front Section: 62.6 mm x 10.8 mm (2.5 in. x 0.43 in.) Rear Section: 62.3 mm x 43.3 mm (2.5 in. x 1.7 in.)
Weight	Front Section: Approx. 7 g (0.25 oz.) Rear Section: Approx. 23 g (0.81 oz.)

(W): Max. wide angle (T): Max. telephoto

*1 When mounted on PowerShot A720 IS (Max. wide angle)

*2 From front of the mounted tele-converter.

*3 Conversion Lens Adapter LA-DC58G is required when mounted on PowerShot A720 IS

*4 When mounted on PowerShot A720 IS (Max. telephoto)

Index

Numerics

1st-curtain	112
2nd-curtain	112
3:2 Guide	117

A

AC Adapter Kit ACK800	174
AE Lock	98
AF Frame	50, 90
AF Lock	95
AF-assist Beam	45, 151
AiAF	90
Aperture Value	85, 86
Auto Play	129
Auto Rotate Function	115
AV cable	146

B

Battery	
Battery Capacity	189
Charging	172
Handling	168
Installing	8

C

Compression	57
Continuous Shooting	87
Create Folder	118
Custom White Balance	105

D

Date/Time	12
Digital Tele-Converter	60
DIGITAL Terminal	26, 38
Digital Zoom	60

Direct Transfer	29
Distance Units	47
Downloading Images to a Computer	
24	
DPOF Print Order	139
DPOF Transfer Order	144

E

Erasing	
All Images	138
Single Images	21
Exposure Compensation	101

F

Face Detect	91
FE Lock	99
File Number	52, 120, 142
Flash	64
Flash Adjustment	110
Flash Output	111
FlexiZone	90
Focus	
AF Lock	95
Lock	94
Manual	96
Safety MF	97
Focus Lock	94
Frame Rate	81
FUNC./SET	40, 42

G

Grid Lines	117
------------------	-----

H

HF-DC1	180
--------------	-----

Histogram 54

I

Image Data Sizes (Estimated) ... 192

Image Stabilizer Function 68

Index Playback 123

Indicator 41

Interface Cable 22, 26

ISO Speed 100

J

Jump (Image Search) 124

L

Language 13

LCD Monitor

 Night Display 49

 Playback Information 52

 Shooting Information 50

 Using the LCD Monitor 49

Lens

 Conversion Lens Adapter ... 176

 Tele-converter 175

 Wide Converter 175

List of Messages 158

M

Macro 65

Magnifying 122

Maintenance 184

Manual Focus 96

Memory Card

 Estimated Capacities 190

 Formatting 56

 Handling 170

 Inserting 10

Menu

 FUNC. Menu 42, 44

 MENU Button 43

Menus and Settings 42, 43

Play Menu 43, 46

Print Menu 46

Rec. Menu 44

Set up Menu 46

Metering Modes 102

MF-Point Zoom 45, 96

Mode Dial 14, 40, 73

Mode Switch 14, 40

Movie 18

 Playback 125

 Shooting 79

Mute 15, 46

My Colors 107

O

Overexposure Warning 53

P

Playback 17, 122

Postcard 70

Power Button 14, 40

Power Saving 41, 47

Print Style 142

Print/Share Button .. 22, 29, 40, 114

Printing 22, 139

Program AE 82

Protect 137

R

Recording Pixels 44, 58

Red-Eye Correction 130

Red-Eye Reduction 38, 88

Reset All 55

Resize 134

Resume Playback 17

Review 16, 45

Rotate 127

S

Safety FE	113
Safety MF	97
Safety Zoom	62
Self-Timer	66
Shooting	14
Shooting Mode	
Creative Zone	73
Av	85
M	86
P	82
Tv	83
Functions Available	206
Image Zone	73
Movie	79
Special Scene	75
Stitch Assist	77
Shutter Button	40
Fully	15, 19
Halfway	15
Shutter Speed	83, 85, 86
Slow Synchro Function	89
Smooth Continuous Shooting	87
Sound Memo	136
Spot AE Point Frame	50, 103
Stitch Assist	77
System Requirements	24

T

Telephoto	59
Troubleshooting	147

V

Video System	146
--------------------	-----

W

White Balance	104
Wide Angle	59
Wrist Strap	8

Z

Zoom	59
------------	----

NOTE

NOTE

NOTE

NOTE

NOTE

FCC Notice

(Digital Camera, Model PC1251 systems)

This device complies with Part 15 of the FCC Rules. Operation is subject to the following two conditions;

- (1) this device may not cause harmful interference, and
- (2) this device must accept any interference received, including interference that may cause undesired operation.

Note: This equipment has been tested and found to comply with the limits for Class B digital devices, pursuant to Part 15 of the FCC rules. These limits are designed to provide reasonable protection against harmful interference in a residential installation. This equipment generates, uses and can radiate radio frequency energy and, if not installed and used in accordance with the instructions, may cause harmful interference to radio communications. However, there is no guarantee that interference will not occur in a particular installation. If this equipment does cause harmful interference to radio or television reception, which can be determined by turning the equipment off and on, the user is encouraged to try to correct the interference by one or more of the following measures:

- Reorient or relocate the receiving antenna.
- Increase the separation between the equipment and receiver.
- Connect the equipment into an outlet on a circuit different from that to which the receiver is connected.
- Consult the dealer or an experienced radio/TV technician for help.

The cable with the ferrite core provided with the digital camera must be used with this equipment in order to comply with Class B limits in Subpart B of Part 15 of the FCC rules.

Do not make any changes or modifications to the equipment unless otherwise specified in the manual. If such changes or modifications should be made, you could be required to stop operation of the equipment.

Canon U.S.A., Inc.

One Canon Plaza, Lake Success, NY 11042, U.S.A.

Tel No. (516) 328-5600

Canadian Radio Interference Regulations

This Class B digital apparatus complies with Canadian ICES-003.

Réglementation canadienne sur les interférences radio

Cet appareil numérique de la classe B est conforme à la norme NMB-003 du Canada.

Disclaimer

- While every effort has been made to ensure that the information contained in this guide is accurate and complete, no liability can be accepted for any errors or omissions.
- Canon reserves the right to change the specifications of the hardware and software described herein at anytime without prior notice.
- No part of this guide may be reproduced, transmitted, transcribed, stored in a retrieval system, or translated into any language in any form, by any means, without the prior written permission of Canon.
- Canon makes no warranties for damages resulting from corrupted or lost data due to a mistaken operation or malfunction of the camera, the software, SD memory cards (SD cards), personal computers, peripheral devices, or use of non-Canon SD cards.

Trademark Acknowledgments



- Microsoft, Windows Vista and the Windows Vista logo are trademarks or registered trademarks of Microsoft Corporation in the United States and/or other countries.
- Macintosh, the Mac logo, QuickTime and the QuickTime logo are trademarks of Apple Inc., registered in the U.S. and other countries.
- The SDHC logo is a trademark.





For CA, USA only

Included lithium battery contains Perchlorate Material - special handling may apply.

See www.dtsc.ca.gov/hazardouswaste/perchlorate/ for details.

Functions Available in Each Shooting Mode

Function	M	Av	Tv	P		AUTO		
Exposure Compensation (p. 101)	–	○	○	○	○	–	○	○
ISO Speed (p. 100)	Auto	–	○	○	○	○	○	○
	High ISO Auto	–	–	–	○	–	○	–
	ISO 80/100/200/400/800/1600	○	○	○	○	–	–	–
White Balance (p. 104)	Auto	○	○	○	○	○	○	○
	Auto, Day Light, Cloudy, Tungsten, Fluorescent, Fluorescent H, Underwater, Custom	○	○	○	○	○	–	–
Drive Mode (pp. 87, 66)	Single Shot	○	○	○	○	○	○	○
	Continuous	○	○	○	○	–	–	○
	Self Timer (2 sec. 10 sec.)	○	○	○	○	○	○	○
	Custom Timer	○	○	○	○	–	○	○
My Colors (p. 107)	○	○	○	○	○	–	–	–
Flash Compensation (p. 110)	–	○	○	○	○	–	–	–
Flash Output (p. 111)	○	○	○	–	–	–	–	–
Metering System (p. 102)	Evaluative	○	○	○	○	○	○	○
	Center Weighted Avg.	○	○	○	○	–	–	–
	Spot	○	○	○	○	–	–	–
Recording Pixels (Still Images) (p. 57)	○	○	○	○	○*1	○	○	○
Recording Pixels/ Frame Rate (Movies) (p. 81)	640 x 480, 30 fps	–	–	–	–	–	–	–
	640 x 480, 30 fps LP	–	–	–	–	–	–	–
	320 x 240, 30 fps	–	–	–	–	–	–	–
	160 x 120, 15 fps	–	–	–	–	–	–	–
Av/Tv Settings (pp. 83, 85)	○	○*2	○*3	–	–	–	–	–
AE/FE Lock (pp. 98, 99)	–	○	○	○	–	–	–	–
Macro (p. 65)	○	○	○	○	○	○	○	–
Manual Focus (p. 96)	○	○	○	○	–	–	○	○
Flash (p. 64)	Auto	–	–	–	○	–	○	○
	On	○	○	○	○	–	○	○
	Off	○	○	○	○	○	○	○
LCD Monitor Setting (p. 49)	Off	○	○	○	○	–	○	○
	LCD Monitor (no information)	○	○	○	○	–	○	○
	LCD Monitor (information view)	○	○	○	○	○	○	○

Function		M	Av	Tv	P		AUTO		
AF Frame (p. 90)	Face Detect	○	○	○	○	—	○	○	○
	AiAF (9 point)	○	○	○	○	—	○	○	○
	Center	○	○	○	○	○	○	○	○
	FlexiZone	○	○	○	○	—	—	—	—
AF Frame Size (p. 92)		○	○	○	○	—	—	—	—
Digital Zoom	Standard (p. 61)	○	○	○	○	—	○	○	○
	Digital Tele-Converter (p. 63)	○	○	○	○	—	○	○	○
Flash Sync (2nd-curtain) (p. 112)		○	○	○	○	—	—	—	—
Slow Synchro (p. 89)		○*4	○	○*4	○	○	—	—	○*4
Flash Adjust (Manual) (p. 109)		○*5	○	○	—	—	—	—	—
Red-Eye (p. 88)		○	○	○	○	○	○	○	○
Safety FE (p. 113)		—	○	○	○	—	—	—	—
Spot Metering Frame (p. 103)	Center	○	○	○	○	○	○	○	○
	AF Point	○	○	○	○	—	—	—	—
MF-Point Zoom (p. 96)		○	○	○	○	—	—	○	○
Safety MF (p. 97)		○	○	○	○	—	—	○	○
AF-assist Beam (p. 45)		○	○	○	○	○	○	○	○
Rec. Review (p. 16)		○	○	○	○	○	○	○	○
Disp. Overlay (p. 117)	Grid Line	○	○	○	○	—	○	○	○
	3:2 Guide/Both	○	○	○	○	—	○	○	○
IS Mode (p. 68)	Continuous	○	○	○	○	○	○	○	○
	Shooting Only/Panning	○	○	○	○	○	○	○	○
Converter (p. 179)		○	○	○	○	○	○	○	○
Date Stamp (p. 71)		○	○	○	○	—	○	○	○
Set   Button (p. 114)		○	○	○	○	○	○	○	○

○: Setting available or optimum value is automatically set by the camera. As a rule, with the "Stitch Assist", only the first image is available.

—: Not available.

 (Shaded Area): Setting is retained even when the camera power is shut off

*1 Postcard date imprint and Widescreen are not available.

*2 Can only be set in **Av** (Setting the aperture).

*3 Can only be set in **Tv** (Shutter speed).

*4 Always set to [On].

*5 Always set to [Off].

*6 Only available when the flash is set to [On].

