

Contents

Additional Help.....	2
Getting started.....	3
Calls.....	12
Entering text.....	16
Contacts	20
Messaging.....	21
Media.....	25
Camera.....	37
Location services.....	43
Internet.....	46
Organiser.....	47
Applications.....	52
Transferring and handling content.....	54
Updating your phone.....	56
Connectivity.....	56
Settings.....	59
Troubleshooting.....	67
Legal information.....	71
Index.....	72

Additional Help

The complete user documentation for your phone consists of:

- User guide (delivered with your phone) – an overview of your phone with the information needed to get you started.
 - Help texts – help in your phone on most applications.
 - Extended User guide – an up-to-date User guide with step-by-step instructions and additional information on features available in your phone. The Extended User guide is available on the Memory card. You can also access this document at www.sonyericsson.com/support.
- ! Please read the **Important information** before you use your mobile phone.

Getting started

Assembly

Before you start using your phone, you need to insert a SIM (Subscriber Identity Module) card and the battery.

To insert the SIM card



- 1 Remove the battery cover.
- 2 Put the SIM card into its holder with the gold-coloured contacts facing down.

To insert the battery



- 1 Insert the battery with the label side up and the connectors facing each other.
- 2 Put the battery cover into place.

Turning on the phone

To turn on the phone



- 1 Press and hold down **(i/m)**.
- 2 Enter your SIM card PIN, if requested, and select **OK**.
- 3 The first time you turn on the phone, follow the instructions to use the setup wizard for basic settings and useful tips.

PIN

You may need a PIN (Personal Identification Number) to activate the services and functions in your phone. Your PIN is supplied by your network operator. Each PIN digit appears as * unless it starts with emergency number digits, for example, 112 or 911. You can see and call an emergency number without entering a PIN.

- ! If you enter the wrong PIN three times in a row, the SIM card is blocked. See *SIM card lock* on page 66.

SIM card

The SIM (Subscriber Identity Module) card, which you get from your network operator, contains information about your subscription. Always turn off your phone and detach the charger before you insert or remove the SIM card.

- 💡 You can save contacts on the SIM card before you remove it from your phone. See *To copy contacts between the memory card and SIM card* on page 21.

Charging the phone

The phone battery is partly charged when you buy it.



To charge the phone using the power adapter

- Connect the phone to a power outlet using the USB cable provided and the power adapter.
-  You can use your phone while it is charging. You can charge the battery at any time and for more or less than 3 hours using the power adapter. You can interrupt the charging without damaging the battery.

To charge the phone using a computer

- Connect the phone to a USB port on a computer using the USB cable provided.

Memory

You can save content on a memory card, in the phone memory and on your SIM card. Photos and music are saved on the memory card, if a memory card is inserted. If not, or if the memory card is full, photos and music are saved to the phone memory. Messages and contacts are saved in the phone memory by default, but you can choose to save them on the SIM card.

To view available memory

- Select **Menu > Organiser > File manager**.

Memory card

Your phone supports memory cards, adding more storage space to your phone. A memory card used in your phone can also be used with other compatible devices.

You can move content between your memory card and the phone memory.

To insert or remove a memory card

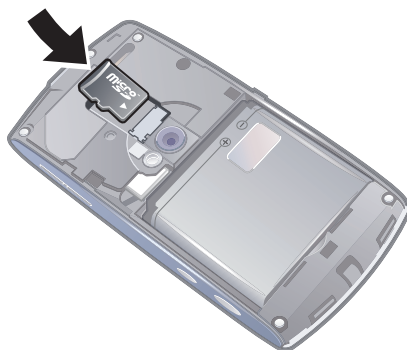

- 1 Insert the memory card with the gold-coloured contacts facing down.
- 2 To remove the memory card, press  and select **Remove memory card**, then press your finger down on the card and slide it out.

Help

You can find **Help** on most applications in **Organiser** or you can access **Help** from within a specific application by selecting **Options**.

To access the general Help in your phone

- Select **Menu > Organiser > Help**.

To view Help when you are in an application

- Select **Options > Help**.

Phone overview

- 1 On/off key, lock key
- 2 Ear speaker
- 3 3.5 mm headset connector
- 4 Connector for USB cable
- 5 Loud speaker
- 6 Touch screen
- 7 End key
- 8 Main menu key
- 9 Call key

- 10 Volume, digital zoom keys
- 11 Camera light
- 12 Camera
- 13 Video key
- 14 Photo key

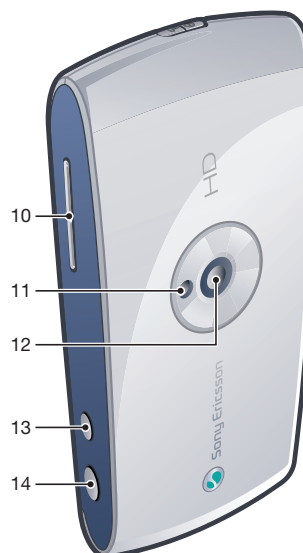
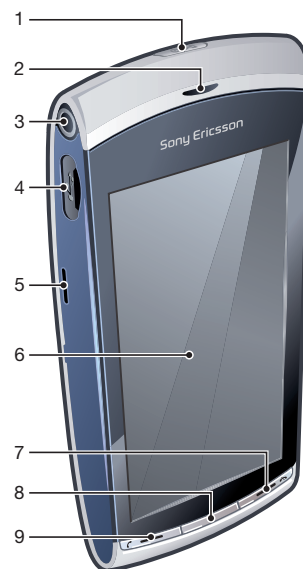

Menu overview*

 **PlayNow™**

 **Internet**

 **Applications**

Radio
TrackID™
Media server
Downl. chat apps
IM
Conversations
Web publishing
Record sound

 **Camera**

 **Messaging**

 **Media**

Photo
Music
Video

 **Location services**

Google Maps
Location
Wisepilot

 **Contacts**

 **Calendar**

 **Log****

 **Organiser**
File manager

Clock
RoadSync
SonyEricsson Sync
Google
Search
Notes
Dictionary
Converter
Calculator
Adobe PDF
Quickoffice
Help

 **Settings**

Personal
Profiles
Themes
Standby
Phone
Date and time
Language
Display
Download settings
Sensor settings
Touch input
Accessories
Application sett.
Phone mgmt.
Application mgr
Installed apps.
Installation files
Install settings
Telephony
Call sett.
Speed dialling

Voicemail
Divert calls
Call barring
Connectivity
Network
Wi-Fi
Bluetooth
USB
Destinations
Connection mgr
Data transfer
Remote drives
Admin. settings

* Some menus are operator-, network- and subscription-dependent.

** You can use touch functionality to scroll between tabs in submenus. For more information, see *Navigation* on page 8.

Navigation

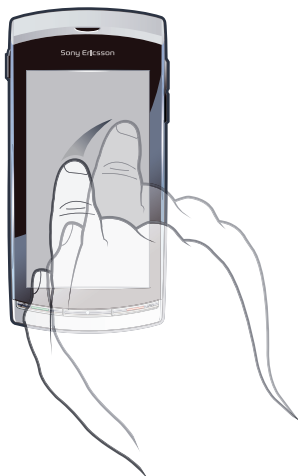

You can move through menus with your fingertips or with a stylus. Tap or double-tap an item to select or open it. You can also switch between running applications.

Main menu

You can access menus from **Menu**. Tap a menu to open it. You can display menus by list or by grid, create your own folders, or move contents between folders.

To access the main menu

- Press the main menu key.

To change the main menu view

- 1 Select **Menu > Options > Change menu view**.
- 2 Select an option.

Automatic keylock and screen guard

The screen and keys may be locked automatically after a period of inactivity.

To change automatic keylock and screen guard settings

- 1 Select **Menu > Settings > Phone > Phone management > Auto. keylock**.
- 2 Select an option.

To unlock the phone manually

- Press  and select **Unlock**.

To lock the phone manually

- Press  twice.

Multitasking

Your phone lets you view and switch between all running applications.

To view running applications

- 1 Press and hold down the main menu key.
- 2 To switch to a running application, tap it.

- ! Leaving applications running in the background increases the demand on battery power and reduces the battery life.

To end a function

- In most cases, select **Options > Exit**.

To delete items

- In most applications, to delete items such as files, folders, messages, or media files, select an item, and then select **Options > Delete**.

Standby





After you have turned on your phone and entered your PIN, the name of the network operator appears. This view is called standby. Your phone is now ready to use.

To return to standby

- Press .

Default standby screen

The default standby screen provides five different views:

	Favourite contacts view
	Social networking view
	Flow view
	Album view
	Shortcuts view

- ! The icon for some views, for example, the Album view, may change according to the content displayed on the standby screen.
- ! These five views are only available when **Sony Ericsson** is selected as the default standby theme.

To switch between standby views

- Tap the icon of the desired view.

To navigate within a standby view

- When within, for example, the Album view, flick your finger up or down on the screen.





Accessing more information

You can access more information from a standby view, for example, to view time and date, to access the standby music player or use the touchbar.

To view more information from a standby view

- To show more information or to show the touchbar, press .
- To go back to the full screen view, tap the area on the screen between the view icons and the touchbar.

To use the touchbar from standby mode

- 1 If the touchbar is not displayed at the bottom of the screen, press .
- 2 Tap one of the following icons:
 -  – make calls.
 -  – go to the main **Media** menu.
 -  – send and receive messages.
 -  – search the phone or the Internet.

To change the wallpaper of a standby view

- 1 Double-tap a view icon and select an option:
 - **Empty** – no wallpaper.
 - **Picture** – display a picture as wallpaper.
 - **Adobe® Flash®** – use a flash file as wallpaper.
 - **Album** – display photos or video clips from **Media** as wallpaper.
 - **Favourite contacts** – display your favourite contacts as wallpaper.
 - **Shortcuts** – display shortcuts to applications or websites as wallpaper.
 - **Twitter** – display the **Twitter™** application as wallpaper.
 - **Flow** – display a wave that adjusts itself horizontally, irrespective of the orientation in which you hold the phone.
 - 2 Select a file, if requested.
 - 3 To save your changes, select **Exit**.
- ! It is not possible to select the same file as the wallpaper for more than one view.

Flow view



Flow view displays a wave that adjusts itself horizontally irrespective of the orientation in which you hold the phone.

Favourites view



The Favourites view provides quick access to your favourite contacts.

With each contact in Favourites view, you can choose to make a call, send a message or view detailed contact information in the Contacts application.

To add a contact to Favourites

- 1 Tap .
- 2 Tap  and select the contact or contacts you wish to add.

To remove a contact from Favourites

- 1 Tap .
- 2 Tap .
- 3 Tap the contact you wish to remove, and select **Yes**.
- 4 To remove more contacts, repeat step 3.

To call a favourite contact

- 1 Tap .
- 2 Tap a contact and select **Call**.

To send a message to a favourite contact

- 1 Tap .
- 2 Tap a contact and select **Message**.

To view details about a favourite contact in Contacts

- 1 Tap .
- 2 Tap a contact and select **View in Contacts**.

Album view

The Album view provides quick access to your photos and video clips.

You can view these contents or send them to other compatible devices. You can also set a photo or video clip as the wallpaper for a standby view.

- 💡 In the Album view, video clips are marked with .

To set a photo as wallpaper

- 1 Tap .
- 2 Tap a photo and select **Set as wallpaper**.

To send a photo or video clip

- 1 Tap .
- 2 Tap a photo or video clip and select **Send as**.
- 3 Select a sending method.

To view a full-size photo in Media

- 1 Tap .
- 2 Tap a photo and select **View in Media**.



To play video clips in the Album view

- Tap a video clip and select **View in Media**.

Shortcuts view

The Shortcuts view provides a list of shortcuts to different applications and bookmarks. You can personalise the shortcuts you wish to show.

To change shortcut settings

- 1 Tap .
- 2 Tap .
- 3 Select a shortcut and tap **Options > Change**.
- 4 When **Shortcut type:** appears, select **Application** or **Bookmark**.
- 5 Double-tap an item.
- 6 To save your settings, select **Back**.

Social networking view

You can access social networking services, for example, Twitter, from this view. You can check your friends' status, or comment on their latest posts.

- ! Before using this service, you must have the required Internet connection settings in your phone.

To change settings for the social networking view

- 1 Tap .
- 2 Change the desired settings and select **Back**.

To comment on new posts

- 1 Tap a post and enter your comments in the text field shown above the post.
- 2 To send your comments, tap .

To refresh the social networking service view

- Tap .

To go to a social networking service website























- When you view a post, tap .

Using other networks

Making and receiving calls, using messaging and data transfer, for example, Internet-based services, outside your home network (roaming) may incur additional costs. Contact your operator for more information.

Status icons

Status icons appear at the top of the screen. You can tap status icons to view more information or change settings.

	Battery fully charged
	Network signal strength
	Messages in the outbox
	GSM available
	Missed call
	Handsfree connected
	Call diverted
	Text message received
	New email received
	Headphone inserted
	GPS connected
	Alarm activated
	Bluetooth™ connected
	Keylock activated
	USB data transferring
	Data synchronising
	Flight mode activated
	Secure Wi-Fi™ network connected
	Wi-Fi™ network connected
	3G available
	HSDPA available
	EGPRS available



Calls

Making and receiving calls

You need to turn on your phone and be within range of a network.

-  The touch screen is disabled automatically during calls when you place your phone next to your ear.

To make a call



- 1 Select  to open the dialler and enter a phone number (with international country code and area code, if applicable).
- 2 Press .

-  You can call numbers from your contacts and call lists.

To end a call

- Press .

To make an international call

- 1 Select , and tap  twice for a “+” sign.
- 2 Enter the country code, area code (without the first zero) and phone number.
- 3 Press .

To set automatic redial

- Select **Menu > Settings > Telephony > Call sett. > Automatic redial > On.**

To answer a call

- Press .

To reject a call

- Press .

To change the ear speaker volume during a call

- Press the volume key up or down.

To mute the microphone during a call

- 1 To mute the microphone, tap **Mute**.
- 2 To reactivate the microphone, tap **Unmute**.

To turn on the loudspeaker during a call

- Tap .

 Do not hold the phone to your ear when using the loudspeaker. This could damage your hearing.

To view missed calls

- Press  to open the call list.

Networks

Your phone switches automatically between GSM and 3G (UMTS) networks, depending on availability. Some network operators allow you to switch networks manually.

To switch networks manually

- 1 Select **Menu > Settings > Connectivity > Network > Network mode.**
- 2 Select an option.

Emergency calls

Your phone supports international emergency numbers, for example, 112 or 911. You can normally use these numbers to make emergency calls in any country, with or without the SIM card inserted, if you are within range of a network.

- ! In some countries, other emergency numbers may also be promoted. Your network operator may therefore have saved additional local emergency numbers on the SIM card.

To make an emergency call

- Select , enter 112 (the international emergency number) and press .

Video calls

You can share experiences with friends and family as they happen and save them to share later. You see the person you are talking to on your screen. The other person sees the video being shot by your camera.

Before making video calls

To engage in a video call, both parties to the call must have a 3G (UMTS) phone subscription that supports the 3G (UMTS) service and 3G (UMTS) coverage.

To make a video call

- 1 Select  and enter a phone number (with international country code and area code, if applicable).
- 2 Select **Video call**.

To answer a video call

- Press .

To end a video call

- Press .

To use the zoom when you are on an outgoing video call

- Select **Options** > **Zoom**.



To view video call options

- During a video call, select **Options**.

Call list

You can view information about recent calls.

To call a number from the call list

- 1 Press  and select a tab.
- 2 Select a name or a number and press .

Speed dial

Speed dialling lets you select eight contacts you can dial quickly from standby. You must assign each speed dial contact a number between 2 and 9.

To assign speed dial numbers to contacts

- 1 Select **Menu** > **Settings** > **Telephony** > **Speed dialling**.
- 2 Select a number from 2 to 9 on your keypad, and select **Options** > **Assign**.
- 3 Select a contact.

To speed dial an assigned number

- Select , enter a speed dial number and press .

More calling features

Voicemail

If your subscription includes an answering service, callers can leave a voicemail message when you cannot answer a call.

To enter your voicemail number

- 1 Select **Menu** > **Settings** > **Telephony** > **Call voicemail** > **Voicemail inbox**.
- 2 Enter the number and select **OK**.

To call your voicemail service

- Select . Touch and hold .

Diverting calls

You can divert calls, for example, to an answering service.

- ! When **Restrict calls** is used, some divert call options are not available.

To divert calls

- 1 Select **Menu** > **Settings** > **Telephony** > **Divert calls**.
- 2 Select a call type and a divert option.
- 3 Select **Activate**.
- 4 Enter the number you want to divert calls to, and select **OK**.

More than one call

You can handle more than one call at a time. For example, you can put an ongoing call on hold while you make or answer a second call. You can also switch between the two calls. You cannot answer a third call without ending one of the first two calls.

Call waiting

You will hear a beep if you receive a second call while call waiting is active.

To activate call waiting

- Select **Menu** > **Settings** > **Telephony** > **Call sett.** > **Call waiting** > **Activate**.

To make a second call

- 1 During a call, select **Keypad**. This puts the ongoing call on hold.
- 2 Enter the number to call, and press .

To answer a second call

- During a call, press  when you hear the beep for a second call. This puts the ongoing call on hold.

To reject a second call

- During a call, select **Reject** and continue with the active call.

To end an active call and answer a second call

- During a call, select **Options** > **End ongoing call** and then select **Answer**.

Handling two voice calls

You can have calls ongoing and on hold at the same time.

To switch between two calls

- During a call, press .



To end an active call and return to the call on hold

- Press  and then press .

Conference calls

The conference call function lets you hold a joint conversation with other people.



To make a conference call

- 1 Make a call to the first participant.
- 2 Select **Keypad**, enter the number of the next participant you want to call, and press .
- 3 When the new call is answered, select .
- 4 To add more participants, repeat step 2.
- 5 When the call is answered, select  to add the new participant to the conference.

To release a participant

- 1 Select .
- 2 Select a participant and select .

To hold a private conversation with one participant

- 1 During the call, select  to show all participants.
- 2 Select the participant you want to hold a private conversation with, and select .

To return to the conference call

- Select .

Restricted dialling

You can restrict outgoing and incoming calls. A password from your service provider is required.

- ! If you divert incoming calls, you cannot use some restrict call options.

To restrict calls

- 1 Select **Menu > Settings > Telephony > Call barring.**
- 2 Select an option.
- 3 Select **Activate.**
- 4 Enter your password and select **OK.**

Call time and cost

During a call, the phone shows how long you have been talking for. You can also check on the duration of your last call, your outgoing calls and the total time of all your calls.

To show the call duration

- Select **Menu > Calls > Call duration.**

Entering text

You can enter letters, numbers and special characters using the on-screen keyboard, alphanumeric keypad or handwriting recognition. You can switch between these input methods.

To enter text

- 1 Tap any text input field. For example, select **Menu > Messaging > New message** and tap in the area of the screen under the **To** field.
- 2 A text input window opens. Tap  and select an option:
 - **Mini QWERTY keyboard** – keyboard in portrait mode.
 - **Full QWERTY keyboard** – keyboard in landscape mode.
 - **Alphanumeric keypad** – traditional keypad.
 - **Handwriting** – handwriting recognition.
- 3 Use your fingertips or the stylus to enter text.

Handwriting

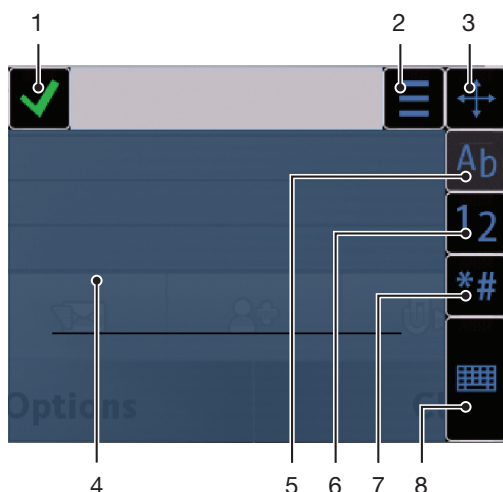

1	Close – tap to accept the text in the input window and close the on-screen keyboard view
2	Options – tap to view options for handwriting
3	Dock – drag and drop to move the handwriting window around the screen
4	Handwriting area
5	Letter mode – tap to switch to alphabetic input mode
6	Number mode – tap to switch to number input mode
7	Symbol – tap to open the symbol table
8	Input options – tap to change to another input method: Mini QWERTY keyboard , Full QWERTY keyboard or Alphanumeric keypad

To open the handwriting window

- 1 Tap any text input field. For example, select **Menu > Messaging > New message** and tap in the area of the screen under the **To** field.
- 2 A text input window opens. Tap  and select **Handwriting**.

To delete text

- Draw a short line leftwards .

To insert a space

- Draw a short line rightwards .

Using keyboards

You can tap a text input field to activate the on-screen keyboard. You can switch between different types of keyboards:

- **Mini QWERTY keyboard** – keyboard in portrait mode.
- **Full QWERTY keyboard** – keyboard in landscape mode.
- **Alphanumeric keypad** – traditional keypad for alphanumeric characters.

Alphanumeric keypad

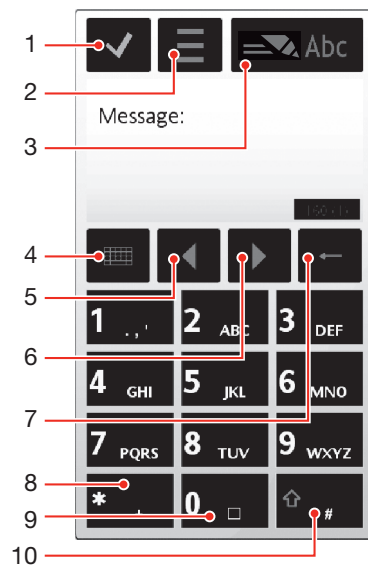









- 1 Close – tap to accept the text in the input window and close the on-screen keypad view
- 2 Options – tap to open the input options menu to change, for example, the **Writing language** or view **Help**
- 3 Text input indicator – tap to open a pop-up window, in which you can turn on or off predictive text input mode, change the character case, and switch between letter and number mode

- 4 Input methods – tap to change to another input method: **Mini QWERTY keyboard**, **Full QWERTY keyboard** or **Handwriting**
- 5 Left – tap to move the cursor to the left
- 6 Right – tap to move the cursor to the right
- 7 Backspace – tap to delete a letter to the left of the cursor
- 8 Symbol – tap to open the symbol table
- 9 Space – tap to enter a space or 0
- 10 Shift – tap to change the character case, turn on or off predictive text input mode, and switch between the alphabet modes and number mode







To activate the alphanumeric keypad

- 1 Tap any text input field. For example, select **Menu > Messaging > New message** and tap in the area of the screen under the **To** field.
- 2 A text input window pops up. Tap  and select **Alphanumeric keypad**.

To enter text using predictive text input

- 1 If  is not displayed in the text input indicator, tap  and select **Activate predictive text**.
- 2 Press each key only once, even if the letter you want is not the first letter on the key. For example, to write the word “Jane”, tap  for J,  for a,  for n and  for e. Write the whole word before looking at the suggestions.
- 3 To view more word suggestions, tap the underlined word. Select a word.
- 4 To add a space, tap .
- 5 To add symbols and punctuation marks, tap .

To enter text using the multitap method

- 1 If  is displayed in the text input indicator, tap  and select **Predictive text > Off** to change to multitap text input.
- 2 Tap  –  repeatedly until the desired letter appears.
- 3 To add a space, tap .
- 4 To add punctuation marks or symbols, tap .

 When using a text input method, you can enter digits by tapping and holding down the number keys.

 To enter punctuation marks, you can also tap  repeatedly until the desired punctuation mark appears.

To add words to the built-in dictionary

- 1 When you enter text using predictive text input, tap  and select **Predictive text > Add word**.
- 2 Write the word using multitap input and select **OK**.

Mini QWERTY keyboard

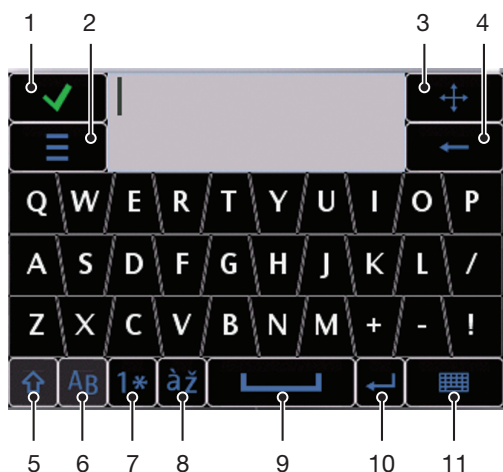

- 1 Close – tap to accept the text in the input window and close the keyboard view
- 2 Options – tap to open the input options menu to change, for example, the **Writing language** or view **Help**
- 3 Dock – touch and hold to move the input window around the screen
- 4 Backspace – tap to delete a letter to the left of the cursor
- 5 Shift and Caps Lock – tap to change the character case
- 6 ABC – tap to display alphabet letters and most-used symbols
- 7 Number mode – tap to display digits and most-used symbols
- 8 Accented letter – tap to display accented letter ranges
- 9 Space – tap to enter a space
- 10 Carriage return – tap to enter a carriage return
- 11 Input options – tap to change to another input method: **Full QWERTY keyboard**, **Alphanumeric keypad** or **Handwriting**

Full screen QWERTY keyboard

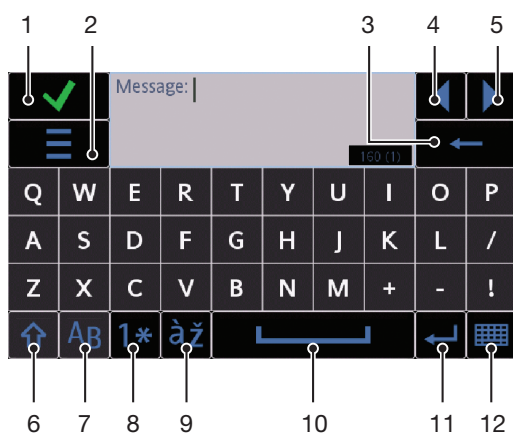

- 1 Close – tap to accept the text in the input window and close the keyboard view
- 2 Options – tap to open the input options menu to change, for example, the **Writing language** or view **Help**
- 3 Backspace – tap to delete a letter to the left of the cursor
- 4 Left – tap to move the cursor to the left
- 5 Right – tap to move the cursor to the right

- 6 Shift and Caps Lock – tap to change the character case
- 7 ABC – tap to display alphabet letters and most-used symbols
- 8 Number mode – tap to display digits and most-used symbols
- 9 Accented letter – tap to display accented letter ranges
- 10 Space – tap to enter a space
- 11 Carriage return – tap to enter a carriage return
- 12 Input options – tap to change to another input method: **Mini QWERTY keyboard**, **Alphanumeric keypad** or **Handwriting**



To activate QWERTY keyboards

- 1 Tap any text input field. For example, select **Menu > Messaging > New message** and tap in the area of the screen under the **To** field.
- 2 A text input window opens. Tap  and select an option:
 - **Full QWERTY keyboard** – keyboard in landscape mode.
 - **Mini QWERTY keyboard** – keyboard in portrait mode.

To change the writing language

- Select **Options > Writing language**.
- 💡 When the text input window is open, you can also tap  and select **Writing language**.

To copy and paste text

- 1 Tap to place the cursor at the beginning of the text you want to select for copying. Then drag your fingertip or stylus to the end of the text.
 - 2 To copy the selected text, tap  and select **Copy**.
 - 3 To paste the text within the same text field, move the cursor to where you want the text be inserted, tap  and select **Paste**.
- 💡 To paste the text to another text field, go to that text field, move the cursor to where you want to insert the text and select **Options > Paste**.

Contacts



You can save names, phone numbers and personal information in **Contacts**. Information can be saved in the phone memory or on the SIM card.

- 💡 You can synchronise your contacts using the *Sony Ericsson PC Suite*.

To open Contacts

- Select **Menu > Contacts**.

To add a new contact

- 1 Select **Menu > Contacts**.
- 2 Tap .
- 3 Add contact information. To close the text input window, tap .
- 4 Select **Done**.

To edit contacts

- 1 Select **Menu > Contacts**.
- 2 Double-tap a contact and select **Options > Edit**.

To select which contacts to display

- Select **Menu > Contacts > Options > Settings > Contacts to display**.

To copy contacts between the memory card and SIM card

- 1 Select **Menu > Contacts**.
- 2 Select a contact and then select **Options > Mark/Unmark > Mark**.
- 3 To mark more than one contact, repeat step 2.
- 4 Select **Options > Copy**.
- 5 Select an option.

! When you copy contacts from the **Phone memory** to the **SIM memory**, only the contact name and phone number will be saved to the SIM card.

To find a contact

- In the search field, enter the first letters of the contact name. The matching contact or contacts appear.



To call a contact

- 1 Select **Menu > Contacts**.
- 2 Select a contact and press .

To make a video call to a contact

- 1 Select **Menu > Contacts**.
- 2 Select a contact and select **Options > Call > Video call**.

To send messages to a contact

- 1 Select **Menu > Contacts**.
- 2 Select a contact and tap .
- 3 To open the text input window, tap the message body.
- 4 Enter text. To close the text input window, tap .
- 5 To send the message, tap .









Messaging

Before you use Messaging

Before you can send or receive messages other than text messages, you need to set up the necessary accounts. You can use the Internet and email wizards provided in the phone to download settings or set up the accounts manually.

Messaging overview

The following icons appear in **Messaging**:

	New message	Create a new message
	Inbox	Received messages, excluding email and cell broadcast messages, are saved here
	Mailbox	Connect to your remote mailbox to download your new email messages, or view your previously downloaded email messages offline
	Sent	The last messages that have been sent, excluding messages sent using Bluetooth connectivity, are stored here. You can change the number of messages to be saved in this folder
	Drafts	Draft messages that have not been sent are stored here
	Outbox	Messages waiting to be sent, for example, when your device is outside network coverage, are temporarily saved here
	Delivery reports	You can request your provider to send you a delivery report of the text messages and multimedia messages you have sent. The availability of this service depends on your network
	My folders	Organise your messages into folders

Text and multimedia messages

Messages can contain text, pictures, sound effects, video clips and presentations. You can also create and use templates for your messages.

When sending messages, the phone automatically selects the most suitable method to use (either a text or multimedia message) for sending the message.

- 💡 If you cannot send or receive multimedia messages, see *I cannot use Internet-based services* on page 69.

To create and send a message

- 1 Select **Menu > Messaging > New message**.
- 2 Tap the **To** field and select a contact name from **Contacts**.
- 3 Tap **OK**.
- 4 Tap the text field and enter your text.
- 5 Select **Options > Add content** and add a picture, video clip or sound.
- 6 To send the message, select .

- 💡 When you enter the phone numbers of multiple recipients manually, use a semicolon to separate their numbers.

To reply to a received message

- Select **Options > Reply**.

To delete a read message

- 1 Select a read message.
- 2 Select .
- 3 To delete the message, select **Yes**.

To save a sender's contact details

- 1 Select **Menu > Messaging > Inbox**.
- 2 Tap the sender's message.
- 3 Select **Options > Save to Contacts > Create new**.
- 4 Enter the sender's phone number, name or email address.
- 5 Select **Done**.

Email

Before you use email

To use email, you need to enter a valid Internet access point (IAP) in the phone and enter your email settings correctly.



You need to create an email account. Follow the instructions given by your remote mailbox and Internet service provider (ISP).

If email settings are missing in your phone, see *Email settings* on page 63.

Sending email messages

You can create email messages from each email account you use with your phone.

To create and send a new email message

- 1 Select **Menu** > **Messaging**.
- 2 Select **Options** > **Create message** > **Email**.
- 3 To select recipients or groups from your contacts list, tap the **To** tab. To enter the number or email address manually, tap the **To** field.
- 4 To enter the subject of your email, tap **Subject**.
- 5 To write the message, tap the message field.
- 6 To attach files to your email message, tap  and select an attachment type. Copyright protection may prevent some images, music and other content from being copied, modified or transferred.
- 7 To view all attachments, tap .
- 8 To use a template or a previously written note, tap **Options** > **Add** and select the desired template or note.
- 9 To send the message, tap .

Receiving email messages

Email messages are downloaded from your email server via the Internet or at your office. You can download your email manually or set when your phone should check for new email.

To download email messages offline

- 1 Select **Menu** > **Messaging** and select a mailbox.
- 2 To open a connection to the remote mailbox, select **Options** > **Connect**.

To download email messages automatically

- 1 Select **Menu** > **Messaging**.
- 2 Select **Options** > **Settings** > **Email** > **Mailboxes**.
- 3 Tap the email account.
- 4 Select **Automatic download**.

To delete email messages from the phone

- 1 Select **Menu** > **Messaging** and select a mailbox.
- 2 Select an email message.
- 3 Select **Options** > **Delete** > **Phone only**. The email messages remain in the remote mailbox.

- ! The email headers that appear in your phone mirror those that appear in the remote mailbox. This means that when you delete the content of a message on your phone, the email header stays in your phone. If you want to remove the header as well, you can connect to the server when deleting the message from your phone. If there is no connection to the server, the header is deleted the next time you connect to the remote mailbox on the server.

To delete an email message from the phone and from the remote mailbox

- 1 Select **Menu** > **Messaging** and select a mailbox.
- 2 Select an email message.
- 3 Select **Options** > **Delete** > **Phone and server**.

To disconnect from the remote mailbox

- To end the data connection to the remote mailbox, select **Options** > **Disconnect**.

To forward an email message

- 1 Select **Menu** > **Messaging** and select a mailbox.
- 2 Select the email message you want to forward.
- 3 Select **Options** > **Forward**.

Viewing messages

You can choose not to receive large messages and to only receive headers.

To download headers

- 1 Select **Menu > Messaging**.
- 2 Select **Options > Settings > Email > Mailboxes**.
- 3 Tap the email account.
- 4 Select **Download settings > Email download**.
- 5 Select **Headers only**.

More about Messaging

Cell broadcast messages

Cell broadcasts allow you to receive messages on various topics, such as weather or traffic conditions, from your service provider. For more information, please contact your service provider.

- ! Cell broadcast messages cannot be received in UMTS networks. A packet data connection may prevent cell broadcast reception.

To view a cell broadcast message

- 1 Select **Menu > Messaging > Options > Cell broadcast**.
- 2 Select the message to view.

Service commands

You can use service commands to enter and send service requests, such as activation commands for network services, to your service provider. Service requests are also known as USSD (Unstructured Supplementary Service Data) commands.

To edit service commands

- 1 Select **Menu > Messaging**.
- 2 Select **Options > Service commands**.

Sent

Your last 20 sent messages are automatically saved in the Sent folder.

To change the number of sent messages saved automatically

- 1 Select **Menu > Messaging**.
- 2 Select **Options > Settings > Other**.
- 3 Enter the number of messages you want to be saved automatically.

Drafts

You can view, edit and send messages you have created but not yet sent in **Drafts**.

To view a message

- 1 Select **Menu > Messaging > Drafts**.
- 2 Select the message.

To send a message

- 1 Select **Menu > Messaging > Drafts**.
- 2 Select the message.
- 3 Tap the **To** field and select a contact name from **Contacts**.
- 4 Tap **OK**.
- 5 To send the message, select .

Delivery reports

You can use **Delivery reports** to keep track of sent text messages and multimedia messages.

- ! Delivery reports are not provided for text messages and multimedia messages sent to email addresses.

To receive delivery reports for text messages

- 1 Select **Menu** > **Messaging**.
- 2 Select **Options** > **Settings** > **Text message** > **Receive report** > **Yes**.

To receive delivery reports for multimedia messages

- 1 Select **Menu** > **Messaging**.
- 2 Select **Options** > **Settings** > **Multimedia message** > **Receive report** > **Delivery and read** or **Delivery**.

My folders

You can view messages saved in your own folders or use message templates in **My folders**.

To create a new folder

- 1 Select **Menu** > **Messaging** > **My folders**.
- 2 Select **Options** > **New folder**.
- 3 Enter a name for the folder.
- 4 Tap **OK**.

Templates

To view a template

- 1 Select **Menu** > **Messaging** > **My folders** > **Templates**.
- 2 Select a template.

To send a message template

- 1 Select **Menu** > **Messaging** > **My folders** > **Templates**.
- 2 Tap a template and select **Options** > **Send**.



To create a template

- 1 Select **Menu** > **Messaging** > **My folders** > **Templates**.
- 2 Select **Options** > **New template**.
- 3 Enter the text.
- 4 To save the template, select **Done**.

Media

With the **Media** application you can manage media files, such as photos, music, other audio tracks and video clips. You can also manage photos and video clips in albums on the web.

The main application features are:

- **Photo** – view, edit, send or blog your photos and video clips.
 - **Music** – categorise and play your music files or other audio tracks.
 - **Video** – play and handle your video clips.
-  You can change between portrait view and landscape view automatically when the auto-rotate setting is on. See *Sensor settings* on page 61.
-  If an audio clip or video clip has its own title in a metadata profile, this title is displayed instead of the file name.

Viewbar and touchbar

You can use the viewbar and touchbar to navigate through different views and manage your media files.

- Viewbar – a bar that appears at the top of the screen (in portrait view) after you select an application in **Media**. Using this bar, you can navigate to play view, to various list views within the same application, or to the main **Media** menu.

- Touchbar – a bar that appears at the bottom of the screen (in portrait view) where you can, for example, mark, edit and manage your media files, or go back to the previous level. To view more options, tap .

 To get tips for an icon in the bars, touch and hold the icon.

To open Media

- Select **Menu > Media**.
- Tap  in the touchbar at the bottom of the standby screen.



 You may need to open **Media** in a different way if you are not using the default standby theme.

To exit Media

- Press  to go to standby.
- If you are in the main **Media** menu, tap  in the touchbar.

 If you minimise **Media** while a sound clip is playing, the clip continues to play. You can control the music player in standby when you are using the default theme.

To navigate in Media

- To go to the next level, tap an icon or title.
- To go back to the previous level, tap  in the touchbar.
- To go to the play view, tap  in the viewbar.
- To go back to the main **Media** menu, tap  in the viewbar.
- When a list or grid view does not display all items, flick up or down to view more.

To go to the play view

- Tap  at the top of the screen.

To view more commands in the touchbar

- Tap  in the touchbar.

Updating media libraries

Your media libraries are updated automatically when you:

- use the **Media** application for the first time.
- finish a media file transfer to your phone using a USB cable.
- disconnect a USB cable to exit Mass Storage mode.
- insert a memory card into your phone.
- select an invalid file.

 If the content saved on the memory card has not changed since the last update, the update process will not start.

To update media libraries manually

- Tap  in the touchbar.

To hide the update dialog box

- Tap **Hide** in the update dialog box.



To close the update dialog box

- Tap **Cancel** in the update dialog box.

Mark mode

You can mark several files and manage them in batches.

To mark media files

- 1 When the files are in list or grid view, tap  in the touchbar.
- 2 Tap the files to highlight them as marked.
- 3 To exit mark mode, tap .

Photo





With the **Photo** function, you can view, send and manage photos in your phone. You can also edit and arrange photos that you have saved in online photo albums. The viewing options are:

- **Latest photo** – the latest taken photo or video clip saved in your phone or on a memory card. The latest taken photo or video clip is shown as the first item.
- **Camera album** – photos and video clips shot using a camera, presented in chronological order, by month.
- **Photo tags** – photos that you have tagged.
- **Web albums** – photos and video clips in online albums. You need the correct Internet settings to use this function.
- **Pictures** – preloaded and downloaded pictures without EXIF (Exchangeable Image File) information, not taken using a camera.

Photo viewbar



In **Photo**, a viewbar appears at the top of the screen.

- | | |
|--|--------------------------------------|
|  | Return to the main Media menu |
|  | Go to Camera album |
|  | Go to Photo tags |
|  | Go to Web albums |
|  | Go to the play view |

To view a photo in full screen

- 1 Select **Menu > Media > Photo**.
- 2 Select a view option and tap a thumbnail to view the photo.
- 3 To view the next or previous photo, flick left or right.

Latest photo

In **Latest photo** you can view all photos and video clips shot by your camera, in chronological order starting with the most recent. Flick from right to left to browse your other photos and video clips. Flick from left to right to go back.

To view your latest photos

- Select **Menu > Media > Photo > Latest photo**.

Camera album

In **Camera album** you can find all the photos and video clips shot using a camera. All the files are categorised by month, in chronological order. Select a month to see the thumbnails, and tap the thumbnail of a photo or video clip to view it.

- 💡 When you view your photos or video clips by month or in thumbnail view, you can mark several items and manage them in batches.

Photo tags



You can manage your photos easily by creating tags for them. In **Photo tags**, you can view all tagged photos. You can also edit your tags.

- 💡 Only photos with EXIF (Exchangeable Image File Format) info can be tagged. If you have no photo tagged, **Photo tags** is empty.



To view photos by tag

- 1 Select **Menu > Media > Photo > Photo tags**.
- 2 Select a tag and tap a thumbnail.



To create a tag

- 1 When viewing a photo, tap  > .
- 2 Tap , enter a new name and select **OK**.
- 3 Select a tag icon.
- 4 Select the created tag to add it to your photo.

To tag a photo

- 1 When in play view or mark mode, tap  > .
- 2 Select a tag.

To remove a tag from a photo

- 1 When viewing a tagged photo, tap  > .
- 2 Tap  on the right of the tag you want to remove.

To edit a tag

- 1 Select **Menu > Media > Photo > Photo tags**.
- 2 Select a tag and tap .
- 3 Edit the tag name and select **OK**.
- 4 Select an icon for your tag.

To delete a tag



- 1 Select **Menu > Media > Photo > Photo tags**.
- 2 Select a tag, tap  and confirm.

Web albums

In **Web albums**, you can manage photos and video clips in albums you create online. You can also add comments to your content or see comments from other people. Select **View demo** to learn more about the basic functions in **Web albums**.

- ! You need the correct Internet settings to use this feature. For more information about the fees that may apply, contact your network operator.

To view a photo in a web album

- 1 Select **Menu > Media > Photo > Web albums**.
- 2 Select a service. If you need to run an update, tap .
- 3 If you are using a service for the first time, enter your username and password, then select **Login**.
- 4 Select an album. If you need to run an update, tap .
- 5 Select a thumbnail and wait until the automatic download is complete before viewing it in a larger size.



To save a photo from a web album to your phone

- 1 When viewing a photo in an online photo album, tap .
- 2 The selected photo is saved in **Photo**.



To search for new web album services

- 1 Select **Menu > Media > Photo > Web albums**.
- 2 Select **New service**.

To view comments on a photo

- 1 When viewing a photo in an online photo album, tap .
- 2 To update the comments, tap .

To add comments to a photo

- 1 When viewing a photo in an online photo album, tap .
- 2 Tap .
- 3 Enter your comments and select **Send**.



To view the details of an online photo



- When viewing a photo in an online photo album, tap .

To change the details of an online photo

- 1 When viewing a photo in an online photo album, tap .
- 2 Change the **File title** or the **Description** in the corresponding fields.



To send photo links



- 1 Select **Menu > Media > Photo > Web albums**.
- 2 Select a service, and select an album.
- 3 Tap  in the touchbar.
- 4 Tap the photos you want to select.
- 5 Tap . See *Messaging* on page 21.

 When viewing a photo in an online photo album, you can also send someone a link to the photo by tapping  in the touchbar.

 You can only send links to photos that have no access restrictions.

To delete photos from an online photo album



- 1 When viewing photo thumbnails in an online album, tap  in the touchbar.
- 2 Tap to select the photos you want to delete.
- 3 Tap  and confirm.

 When viewing a photo in an online photo album, you can also delete it by tapping  in the touchbar.

To change the details of a web album

- 1 Select **Menu > Media > Photo > Web albums**.
- 2 Select a service, and select an album.
- 3 Tap .
- 4 Change the album title, description or visibility in the corresponding fields.

To send web album links

- 1 Select **Menu > Media > Photo > Web albums**.
- 2 Select a service.
- 3 Tap  in the touchbar.
- 4 Tap to select the photo albums for which you want to send links.
- 5 Tap .

 You can only send links to albums that have no access restrictions.

To log out of a web album

- 1 Select **Menu > Media > Photo > Web albums**.
- 2 Tap  in the touchbar.
- 3 Tap to select the service you want to log out of.
- 4 Tap  and confirm.

Pictures

In **Pictures**, all pictures without EXIF information are shown in thumbnails, in chronological order. Tap a thumbnail to view a picture.

 When viewing pictures in thumbnails, you can mark several items and manage them in batches.

Viewing pictures













When viewing pictures in play view, you can:

- tap the screen to show or hide the touchbar and other information. The creation time of the file in view is shown at the top of the screen.
 - flick right or left to view the previous or the next picture file.
 - manage picture files using the touchbar.
- ! To get tips, you can touch and hold each icon in the touchbar.



Managing photos in play view

You can manage your photos in many ways. For example, you can edit, tag or use a photo, or send a photo to other devices. You can also view photos as a slideshow.



When viewing a photo, you may find these icons in the touchbar:

-  Exit the play view and go back to the previous level
-  Delete the current photo
-  Send the current photo
-  View more commands
-  Photo information
-  Zoom the photo
-  Print the photo
-  Edit the photo
-  Set the photo as a contact picture
-  Set the photo as wallpaper
-  Set the photo as a call image
-  Tag the photo
-  View photos as a slideshow





To view photo information

- When viewing a photo, tap  > .

To print a photo

- When viewing a photo, tap  > .



To zoom a photo

- 1 When viewing a photo, tap  > .
- 2 Tap  to zoom in. Tap  to zoom out.

Editing photos

When viewing a photo, you can edit it in several ways. For example, you can change the contrast or brightness of a photo. You can also add items such as text or picture clips to a photo.

To edit a photo

- 1 When viewing a photo, tap  > .
- 2 Select **Options** and select an item.
- 3 To cancel all the changes and return to the main view, select **Options** > **Cancel changes**.

! Copyright protection may prevent some pictures and other content from being copied, modified, or transferred.



To undo the last editing action

- From edit view, select **Options** > **Undo**.



To save an edited photo

- From edit view, select **Options** > **Save**.



To adjust photo brightness

- 1 When viewing a photo, tap  > .
- 2 Select **Options** > **Add effect**.
- 3 Tap  and drag the slider to adjust the brightness.
- 4 Select **OK** to confirm.



To adjust photo contrast

- 1 When viewing a photo, tap  > .
- 2 Select **Options** > **Add effect**.
- 3 Tap  and drag the slider to adjust the contrast.
- 4 Select **OK** to confirm.





To adjust photo sharpness

- 1 When viewing a photo, tap  > .
- 2 Select **Options** > **Add effect**.
- 3 Tap  and drag the slider to adjust the sharpness.
- 4 Select **OK** to confirm.



To decrease the size of a photo

- 1 When viewing a photo, tap  > .
- 2 Select **Options** > **Add effect**.
- 3 Tap  and decrease the photo size.
- 4 Select **OK** to confirm.



To crop a photo

- 1 When viewing a photo, tap  > .
- 2 Select **Options** > **Add effect**.
- 3 Tap  and select from the two options:
 - **Manual** - you can set the shape, size and position of the crop area.
 - **Wallpaper** - the dimensions of the area you want to crop are fixed to a wallpaper shape.
- 4 Drag  to set the shape and size of the crop area.
- 5 Drag within the crop area to move the crop frame around the photo.
- 6 Select **Crop**.



To rotate and save a photo

- 1 When viewing a photo, tap  > .
- 2 Select **Options** > **Add effect**.
- 3 Tap  to rotate the photo clockwise.
- 4 Select **Options** > **Save**.



To insert a talk bubble into a photo

- 1 When viewing a photo, tap  > .
- 2 Select **Options > Add effect**.
- 3 Tap  and select a talk bubble.
- 4 To move the talk bubble, select **Options > Move talk bubble** and drag it to the desired place.
- 5 To resize the talk bubble, select **Options > Resize talk bubble** and drag on the screen to resize it.
- 6 To rotate the talk bubble, select **Options > Rotate talk bubble** and drag on the screen to rotate it.
- 7 To return to the main view, select **Done**.



To insert clip art into a photo

- 1 When viewing a photo, tap  > .
- 2 Select **Options > Add effect**.
- 3 Tap  and select a clip art icon.
- 4 To move the clip art, select **Options > Move clip art** and drag it to the desired place.
- 5 To resize the clip art, select **Options > Resize clip art** and drag on the screen to resize it.
- 6 To rotate the clip art, select **Options > Rotate clip art** and drag on the screen to rotate it.
- 7 To return to the main view, select **Done**.





To insert text into a photo

- 1 When viewing a photo, tap  > .
- 2 Select **Options > Add effect**.
- 3 Tap  and enter the text.
- 4 To move the text, select **Options > Move text** and tap the place you want to move the text to.
- 5 To increase or decrease the text size, select **Options > Resize text** and drag up or down.
- 6 To rotate the text, select **Options > Rotate text** and drag clockwise or anti-clockwise.
- 7 To change the text colour, select **Options > Change colour**.
- 8 To return to the main view, select **Done**.



To posterise a photo

- 1 When viewing a photo, tap  > .
- 2 Select **Options > Add effect** and tap .

To add a frame to a photo

- 1 When viewing a photo, tap  > .
- 2 Select **Options > Add effect**.
- 3 Tap  and tap  or  to select a frame.
- 4 Select **OK**.

To reduce the red-eye effect in a photo

- 1 When viewing a photo, tap  > .
- 2 Select **Options > Add effect**.
- 3 Tap .
- 4 Drag the circle so that it covers the red eye you want to treat.
- 5 To increase or decrease the size of the selection circle, drag up or down outside the circle.
- 6 Select **Options > Reduce red-eye effect**.
- 7 Select **Done**.

To add filter effects to a photo

- 1 When viewing a photo, tap > .
- 2 Select **Options** > **Add effect**.
- 3 Choose a filter effect:
 - – black and white.
 - – sepia: gives the picture a brown tint like old photographs.
 - – negative: inverts red, green and blue separately, and to varying degrees.

To set a photo as your call picture

- 1 When viewing a photo, tap > .
- 2 The photo shows as the background picture when you make a call.

To assign a photo to a contact

- 1 When viewing a photo, tap > .
- 2 Select one or several contacts.
- 3 Select **OK**.

Slideshow

You can view your photos as a slideshow.

To view photos as a slideshow

- When viewing a photo, tap > .
- When in photo list or grid view, mark the photos and tap > .

To pause a slideshow

- When viewing photos in a slideshow, tap the screen and select **Pause**.

To resume a slideshow

- When the slideshow is paused, tap the screen and select **Continue**.

To stop a slideshow

- When viewing photos in a slideshow, tap the screen and select **Stop**.

To zoom a photo in a slideshow

- 1 When viewing photos in a slideshow, select **Stop**.
- 2 Tap the screen to show the zoom slider.
- 3 Drag the slider to zoom the photo.

To exit a slideshow

- 1 When viewing photos in a slideshow, tap the screen and select **Stop**.
- 2 Select **Back**.

Music

You can listen to music, audiobooks, podcasts and your recordings.

Music viewbar



In Music, a viewbar appears at the top of the screen when you are in portrait view.



Return to the main **Media** menu



Go to **Artists**



Go to **Albums**



Go to **Tracks**



Go to the play view

To play music or other audio tracks

- 1 Select **Menu > Media > Music**.
- 2 Browse for tracks in **Artists, Albums, Tracks, Playlists, Audiobooks, Podcasts** and **My recordings**.
- 3 Tap a track.

Audiobooks

You can listen to audio books in your phone, but first you need to transfer the desired audio book to your phone before it appears in your list of available audio books.

To access audio books in your phone

- Select **Menu > Media > Music > Audiobooks**.
- ! Audio books are not listed under Artists, Albums or Tracks.

Playback controls

The following playback controls may appear in your music player and video player:



Pause



Play



Touch and hold to rewind. Tap to go to the previous track



Touch and hold to fast forward. Tap to go to the next track

Additional music controls

The following music controls may appear in your music player:



Turn on shuffle to play tracks in the current playlist in a random order



Turn off shuffle



Repeat all tracks in the current playlist



Repeat the current track several times



Disable repeating tracks

To stop playing music

- When a track is playing, tap

To turn on the shuffle

- When the music player is open, tap **SHUF**. The icon becomes undimmed.

To turn off the shuffle

- When the music player is open, tap **SHUF**. The icon becomes dimmed.

To repeat the current track

- When the music player is open, tap or until appears.

To repeat all tracks in the current playlist

- When the music player is open, tap or until appears.

To turn off the repeat

- When the music player is open, tap or until appears.

To rewind and fast forward

- Touch and hold  or .

To move between tracks

- Tap  or .

To change the volume

- Press the volume key up or down.











To minimise the music player

- 1 When the music player is open, tap .
 - 2 To restore the music player on the screen, tap the minimised album artwork.
- ! When you minimise the music player, the album artwork is also minimised.

Managing tracks in play view

You can manage your tracks in many ways when playing them. You can, for example, delete a track, send a track, set a track as your ringtone or add a track to a playlist.



The following icons may appear in the touchbar when a track is playing:

-  Exit the play view and go back to the previous level
-  Go to the music library
-  Adjust the volume
-  View more commands
-  Delete the current track
-  Send the current track
-  Set the current track as your ringtone
-  Add the current track to a playlist
-  View track information
-  Minimise the music player



To delete a track

- 1 When the music player is open, tap  > .
- 2 Select an option.



To send a track

- 1 When the music player is open, tap  > .
- 2 Select a sending method.

To set a track as your ringtone

- 1 When the track is playing, tap  > .
- 2 Select the profile or profiles for which you want to set the track as the ringtone.

To add the current track to a playlist

- 1 When the track is playing, tap  > .
- 2 Select a playlist.



To view track information

- When a track is playing, tap  > .



Playlists

You can create playlists to organise your music. You can add tracks and folders to a playlist. It may take a few minutes for the phone to create a playlist.



To create a playlist

- 1 Select **Menu > Media > Music > Playlists**.
- 2 Tap **New playlist**.
- 3 Enter a name and select **OK**.
- 4 To add tracks, select, for example,  from the viewbar and tap .
- 5 Select the tracks you want to add to the playlist and tap .
- 6 Select the playlist.

To add tracks to a playlist

- 1 Select **Menu > Media > Music**.
- 2 Select, for example, **Tracks** and tap .
- 3 Select the tracks you want to add to a playlist and tap .
- 4 Select the playlist.

To remove tracks from a playlist

- 1 Select **Menu > Media > Music > Playlists**.
- 2 Select a playlist and tap .
- 3 Select the tracks you want to remove and tap .
- 4 Select **Yes**.

Video





In **Video**, you can browse and play video clips saved in your phone. The following features are available:

- **YouTube** – a direct link to the YouTube™ web site and a wide range of video clips.
- **Videos** – video clips saved in your phone excluding those captured by a camera or identified as podcasts.
- **Camera videos** – video clips shot by a camera.
- **Podcasts** – all video files that are identified as podcasts.

Video viewbar



In **Video**, a viewbar appears at the top of the screen when you are in portrait or landscape view.

- | | |
|---|--------------------------------------|
|  | Return to the main Media menu |
|  | Go to Videos |
|  | Go to Camera videos |
|  | Go to Podcasts |
|  | Go to the play view |

To play a video clip

- 1 Select **Menu > Media > Video**.
- 2 Select an option.
- 3 Tap a video clip.

To show or hide the video control bar in landscape view

-  After the video player is open for a few seconds in landscape view, the control bar becomes hidden automatically.
- To show the control bar, tap any part of the screen.

- To hide the control bar, tap the screen or wait for a few seconds.











To control the video player

- Use the playback controls to control your video player. See *Playback controls* on page 34.

Managing video clips in play view

You can manage your video clips in many ways while they are playing.

The following icons may appear in the touchbar when a video clip is playing:



-  Exit the play view and go back to the previous level
-  Turn on auto-zoom
-  Turn off auto-zoom
-  Set the volume
-  View more options
-  Delete the current video clip
-  Send the current video clip
-  View video clip information
-  Repeat the current video clip
-  Disable the repeated playback of video clips

Camera

Using the camera



Your phone has a 8.1 megapixel camera and a 3.2 nHD touch display with touch capture, face detection, smile detection, light and image stabiliser functions.

To activate the camera

- To activate the photo camera, press .
- To activate the video camera, press .

Viewfinder



- 1  Zoom in or out
- 2  Enter video mode and shoot video clips
- 3  Enter photo mode and take photos

To turn off the camera

- Press .









Viewfinder view

The viewfinder is the primary interface between you and the camera. It shows you what the camera is doing and has shortcuts to camera settings and the most used menu options. You can tap icons in the viewfinder to change settings or to view tips and tricks. The viewfinder has two modes: photo mode and video mode.



Viewfinder behaviour

- To dismiss all icons, tap the screen. To bring back all icons and options, tap again. Dismissing the icons gives you a clearer overview when taking photos and filming video clips.

To take a photo

- 1 To activate the camera, press .
 - 2 To use auto focus, press  halfway down.  begins to blink.
 - 3 When  appears, press  fully down to take the photo. The photo is saved automatically.
-  To take a photo more quickly, you can skip step 2 and press  fully down.
 -  Do not take photos when there is a strong light source in the background. Use a support or the self timer to avoid blurred photos.

To record a video clip

- 1 Press .
- 2 Press  fully down to start recording.
- 3 To stop recording, press  fully down. The video is saved automatically.

To use the zoom

- Press the volume key up or down.
-  The zoom rate reverts to default when you change the shoot mode or switch between photo mode and video mode. See *Shoot mode* on page 39.

To view photos and video clips









- 1 Activate the camera and tap .
- 2 To view the next or the previous photo or video clip, flick left or right.

Camera icons and settings

You can change camera settings by tapping icons in the viewfinder.

Scenes

When you take a photo, you can select a scene setting that best suits your subject:

-  **Auto**
-  **Portrait** – emphasises skin tones and a slightly soft appearance
-  **Landscape** – prioritises distant objects
-  **Twilight landsc.** – use when the lighting conditions are poor and you do not want to use the light. Due to the long exposure time, you should hold the camera still or place it on a stable surface
-  **Sports** – short exposure time to minimise motion blur
-  **Document** – text and drawings will be sharp, with high contrast
-  **Twilight portr.** – longer exposure time. You should hold the camera still or place it on a stable surface
-  **Beach/Snow** – use in bright environments to avoid overexposed photos.

Shoot mode

You can select the way you take a photo.



Normal



Panorama – take wide panorama photos automatically. Three photos are taken sequentially and connected to each other to form a seamless wide picture









Smile detection – activate smile detection and then press . When the person in focus smiles, the camera takes a photo automatically



Touch capture – tap within the white border to select the focus point and take a photo



To take a panorama photo

- 1 To activate the camera, press .
 - 2 Tap  > .  appears at the top of the screen.
 - 3 To take the first photo, press .
 - 4 To take the second photo, move the camera left or right until the indicator fits into  and becomes fully green. The photo is taken automatically and the direction of the panorama is now fixed.
 - 5 To take the third photo, move the camera in the same direction as the previous shot until the indicator fits into  and becomes fully green. The photo is taken automatically.
- ! It is only possible to change zoom in panorama mode before the first photo is taken. The zoom remains the same for the subsequent two photos.

To use smile detection

- 1 To activate the camera, press .
- 2 Tap  > .
- 3 To start smile detection, press .  blinks.
- 4 When the face in the viewfinder smiles,  stops blinking and the photo is taken automatically.

To take a photo in touch capture mode

- 1 To activate the camera, press .
 - 2 Tap  > .
 - 3 Tap within the white border to select the focus point. A photo is then taken automatically.
- ! Do not touch the viewfinder until you want to take a photo.

Focus

When shooting a photo or a video clip, you can select how the camera should focus. Focus settings in photo mode are:



Infinite – for long distance objects

Auto* – the camera chooses where to focus automatically





Macro – for close-ups



Face detection – brings an off-centre face into focus. The camera detects one face automatically before taking a photo

* No icon appears when this function is activated.

To set face detection

- 1 To activate the camera, press .
 - 2 Tap  > .
- ! Face detection is not available in Landscape, Document or Twilight landscape scenes.

Exposure

Exposure settings control the amount of time that light is allowed to enter the camera when taking a photo or filming a video clip. The smaller the exposure value, the darker the photo or video clip will appear. The default exposure value is zero. You can change the exposure value on the slide bar within the range of -2.0 to +2.0.

To set exposure levels in photo mode

- 1 Activate the camera and tap .
- 2 Tap the slide bar that appears.

Self-timer

You can use the self-timer to take photos and film video clips with a time delay. This helps to avoid blurred photos. You can also use this function to take photos of yourself.

 **Off *** – turn off the self-timer

 **On, 2 s** – take photos with a two-second time delay

 **On, 10 s** – take photos with a 10-second time delay

* No icon appears when this function is activated.

To use the self-timer in photo mode

- 1 Activate the camera.
 - 2 Tap  > **Photo** > **Self-timer**.
 - 3 Select **On, 2 s** or **On, 10 s**.
- ! In panorama mode, the self-timer can only be used to take the first photo of the sequence. In touch capture mode, the self-timer is not available.

Picture size

Picture size determines the resolution for a photo. Large sizes give you sharper photos; small sizes allow you to save more photos in the memory. You can select a picture size that corresponds to the size of the planned printout of the photo.

To set picture size

- 1 Activate the camera.
- 2 Tap .
- 3 Select **Photo** > **Picture size**.
- 4 Select an option.

Light

You can turn on the light when taking a photo or filming a video clip, regardless of the lighting conditions.

To turn on the light before taking a photo

- 1 Activate the camera and tap .
- 2 Select **Photo** > **Light** > **On**.

White balance

The white balance function adjusts the photo or video clip colour balance according to the lighting conditions.

Off

take photos without a shutter sound

To set the shutter sound

- 1 Activate the camera and tap .
- 2 Select **Photo > Shutter sound**.

Location information

When  appears on the screen, your geographical position is saved with the photos you take. This is called geotagging. Geotags show the approximate location of where a photo was taken.

To add location information to a photo

- 1 Activate the camera and tap .
- 2 Select **Setup > Geotag > On**.

Auto rotate

When this function is on, a photo appears in the same orientation (landscape or portrait) as when it was originally taken.

To turn on auto rotate

- 1 Activate the camera and tap .
- 2 Select **Setup > Auto rotate > On**.

Reset

You can reset your camera to the factory default settings.

To reset camera settings

- 1 Activate the camera and tap .
- 2 Select **Setup > Reset > Yes**.

Night mode

When filming video clips in dark conditions, you can turn on **Night mode** to increase the exposure time and improve video clip quality. The camera is more sensitive to movement when you use this function.

To turn on night mode

- 1 To activate the video camera, press .
- 2 Tap  > .

Microphone

When filming a video clip, you can control whether sound is recorded with the video or not.

To turn off the microphone

- 1 To enter video mode, press .
- 2 Tap  > .

Video format

You can select different video formats for different purposes.

Auto review

When the **Auto review** is on, you can preview or manage photos or videos you have just shot.

To activate the Auto review

- 1 Activate the camera and tap .
- 2 Select **Setup > Auto review > On**.

To return to photo mode after taking a photo

- After taking a photo, tap .
- ! To return to photo mode, you need to turn on **Auto review**. See *To activate the Auto review* on page 43.

To delete a photo you have just taken

- After taking a photo, tap .
- ! To return to photo mode, you need to turn on **Auto review**. See *To activate the Auto review* on page 43.

Sending photos or video clips

You can send photos and video clips in a multimedia message or you can use other connection methods, such as Bluetooth wireless technology. You can also upload photos and video clips to a compatible online album.

To optimise the size of the photo or video clip for sending, select the appropriate photo or video quality using the camera settings.

To send a photo you have just taken

- 1 After taking a photo, tap .
 - 2 Select an option.
- ! To return to photo mode, you need to turn on **Auto review**. See *To activate the Auto review* on page 43.

Location services

Your phone has a GPS receiver that uses satellite signals to calculate your location. You can get help to find your way to a destination and save your favourite locations. With information from mobile towers near you, you may be able to view your approximate location on a map.

- ! If you cannot use some GPS features, see *I cannot use Internet-based services* on page 69.

To access location services

- Select **Menu > Location services**, and select an application.
- ! You need a GPS connection to use location services. To use GPS, you need to define a packet data Internet access point. See *I cannot use Internet-based services* on page 69.

Using GPS

Your location can be found when you have a clear view of the sky. If your location is not found after a few minutes, move to another location. To help the search, stand still and do not cover the GPS antenna, which is located in the upper right part of the phone.

- ! Some GPS features use the Internet. Data rates and charges may apply.



Favourites

You can save the position information of your favourite places. You can also categorise your favourite places, add information such as a web address and phone number to them, or send them to compatible devices.

To add a new place to your favourites list

- 1 Select **Menu > Location services > Location > Favourites**.
- 2 Select **Options > New location** and select an option:
 - **Current position** – locate your current position and add it to your favourites.
 - **Enter manually** – enter the geographical coordinates and other information about a favourite place.

To categorise favourites

- 1 Select **Menu > Location services > Location > Favourites**.
- 2 Select a favourite, and select **Options > Add to category**.
- 3 Select one or more categories, and select **OK**.

To change icons for your favourites

- 1 Select **Menu > Location services > Location > Favourites**.
- 2 Select a favourite, and select **Options > Location icon**.
- 3 Double-tap an icon.

To send favourites

- 1 Select **Menu > Location services > Location > Favourites**.
- 2 Select a favourite.
- 3 Select **Options > Send** and select an option.

GPS data

You can view route information to a selected destination, position information about your current location, and travel information, such as the approximate distance to your destination and the approximate duration of travel.

To view GPS data

- 1 Select **Menu > Location services > Location > GPS data**.
- 2 Select an option:
 - **Navigation** – view information about how to get to your trip destination.
 - **Position** – view positioning information about your current location.
 - **Trip distance** – view information on the distance travelled during your current trip.

Satellite status

You can check how many satellites your phone has detected, and whether your phone is receiving satellite signals.

To view the satellite status

- Select **Menu > Location services > Location > GPS data > Position > Options > Satellite status**.

Location requests

External services may ask for your location. You can allow external services to use information about your location, or you can restrict them from doing so.

To handle position requests

- When you receive a position request, a message appears showing the service that is making the request. Select **Accept** to allow your position information to be sent, or select **Reject** to deny the request.

Positioning settings

Before using GPS services, you can adjust positioning settings, for example, GPS positioning methods and notation preferences.

To set the positioning method

- 1 Select **Menu > Location services > Location > Positioning > Positioning methods**.
- 2 Select an option:
 - **Internal GPS** – use the integrated GPS receiver in your phone.
 - **Bluetooth GPS** – use a compatible external GPS receiver with Bluetooth connectivity.
 - **Network based** – use information received from the mobile network.

To set the positioning server

- Select **Menu > Location services > Location > Positioning > Positioning server**.
-  The access point and server address may be preset by your service provider, and you may not be able to edit the settings.

Notation preferences

You can change the measurement system for speeds and distances, or change the coordinate format for locations.

To change notation preferences

- 1 Select **Menu > Location services > Location > Positioning > Notation preferences**.
- 2 To change measurement system preferences, tap **Measurement system**.
- 3 To change coordinate format preferences, tap **Coordinate format** and select an option.
- 4 To save your changes, select **Back**.

Google Maps™

Google Maps™ lets you view your current location, find other locations and get directions to a destination.

When you start Google Maps, your approximate location is shown using information from nearby mobile towers. Your location is updated with a more precise position when the GPS receiver finds your location.

To use Google Maps

- Select **Menu > Location services > Google Maps**.

To learn more about Google Maps

- When you use Google Maps, select **Options > Help** to view tips and shortcuts.

Driving directions

Wisepilot™ guides you to your destination using voice instructions. A trial version of Wisepilot may be included in your phone.

- ! Sony Ericsson does not warrant the accuracy of any directional services including but not limited to turn-by-turn navigational services.
- ! Wisepilot may not be available in every market. For more information, go to www.sonyericsson.wisepilot.com.

To start Wisepilot™

- Select **Menu** > **Location services** > **Wisepilot™**.

Internet

- 💡 Before you use the Internet, you may need to define an access point. See *To create a new access point* on page 58.

To start the Internet browser

- 1 Select **Menu** > **Internet**.
- 2 Tap , and enter a web address.
- 3 Select **Go to**.

To exit the Internet browser

- Select **Options** > **Exit**.

Bookmarks

You can create and edit bookmarks as quick links to your favourite web pages.

To create a bookmark

- 1 When you browse the Internet, select **Options** > **Web page options** > **Save as bookmark**.
- 2 Enter a bookmark name and select **OK**.

To select a bookmark

- 1 Select **Menu** > **Internet**.
- 2 Tap  > **Bookmarks**.
- 3 Double-tap a bookmark.

History pages

You can view a list of recently browsed web pages.

To view history pages

- 1 Select **Menu** > **Internet**.
- 2 Tap  > **Bookmarks**.
- 3 Tap **Recently visited pages**.

More browser features





To zoom a web page

- When you browse the Internet, select .

To save a picture from a web page

- 1 When you browse the Internet, select **Options** > **Display options** > **View pictures**.
- 2 Select a picture and select **OK**.
- 3 Tap the picture, and select **Options** > **Save**.



To find text on a web page

- 1 When you browse the Internet, tap  > .
- 2 Enter the search text and tap  or .

To send a link

- 1 When you browse the Internet, select **Options** > **Web page options** > **Send**.
- 2 Select a transfer method.

To view web pages in full screen mode

- 1 When you browse the Internet, tap .
- 2 Tap .
- 3 To return to normal view, tap the black square at the bottom right part of the screen.



Web feeds

Using web feeds, you can subscribe to and download frequently updated content, such as news, podcasts or photos.



To add new feeds

- When you browse a page on the Internet that offers web feeds, indicated by , select **Options** > **Subscribe to web feeds**.

To view web feeds

- 1 When you browse the Internet, tap  > .
- 2 To open all web feeds, tap .
- 3 Select the web feeds you want to view.

To update web feeds manually

- 1 When you open the web feeds list, select a web feed and tap .
- 2 To update all web feeds, tap .

To adjust settings for automatic updates of web feeds

- 1 When you browse the Internet, select **Options** > **Settings** > **Web feeds**.
- 2 Select **Automatic updates** and select an option.

Podcasts

Podcasts are files (for example, radio programmes or video content) that you can download and play. You can subscribe to and download podcasts, using web feeds.

To access audio podcasts

- Select **Menu** > **Media** > **Music** > **Podcasts**.

To access video podcasts

- Select **Menu** > **Media** > **Video** > **Podcasts**.

Organiser

File manager

You can use **File manager** in your phone to handle content saved in the phone memory or on a memory card. If the memory is full, delete some content to create space.

To find files

- 1 Select **Menu** > **Organiser** > **File manager**.
- 2 Select **Options** > **Find** and select a target folder.
- 3 Enter a search text that matches the file name, and select **Find**.

To organise items

- 1 Select **Menu > Organiser > File manager**.
- 2 Find an item and select **Options > Organise**.
- 3 Select an option.

To sort files by category

- 1 Select **Menu > Organiser > File manager**.
- 2 Find a target file and select **Options > Sort by**.
- 3 Select a desired category.

Backing up and restoring

You can back up and restore contacts, the calendar, tasks, notes and bookmarks using the Sony Ericsson PC Suite.

Before backing up and restoring, you need to install the Sony Ericsson PC Suite, which is available through PC Companion or from www.sonyericsson.com/support.

You can back up and restore files within your phone using a MicroSD™ memory card. You can move content between the memory card and the phone memory.

To make a backup using the Sony Ericsson PC Suite

- 1 **Computer:** Start the Sony Ericsson PC Suite from *Start/Programs/Sony Ericsson/Sony Ericsson PC Suite*.
- 2 Follow the instructions in the Sony Ericsson PC Suite on how to connect.
- 3 Go to the backup and restore section in the Sony Ericsson PC Suite and make a backup of your phone content.

To restore phone content using the Sony Ericsson PC Suite

- ! The Sony Ericsson PC Suite overwrites all phone content during the restore process. You may damage your phone if you interrupt the process.
- 1 **Computer:** Start the Sony Ericsson PC Suite from *Start/Programs/Sony Ericsson/Sony Ericsson PC Suite*.
 - 2 Follow the instructions in the Sony Ericsson PC Suite on how to connect.
 - 3 Go to the backup and restore section in the Sony Ericsson PC Suite and restore your phone content.

To back up files on a memory card

- 1 Select **Menu > Organiser > File manager > Backup**.
- 2 Select **Backup contents** and select one or more options.
- 3 Select **Repeat backup** and select an option.
- 4 Select **Options > Back up now**.

To restore files to the phone memory

- 1 To move content from the memory card to your phone memory, select **Menu > Organiser > File manager > Backup**.
- 2 Select **Options > Restore**.
- 3 Select the files you want to move, and select **OK**.
- 4 Select **Yes**.

Clock

Alarm clock

The alarm sounds even if the phone is turned off. When the alarm sounds, you can silence it or turn it off. You can set the alarm not to sound when the phone is in silent mode.

To set a new alarm

- 1 Select **Menu > Organiser > Clock > New alarm.**
- 2 Select **Alarm time:** and enter the time.
- 3 Select **Description** and enter the alarm title.
- 4 Select **Repeat** and select an option.

To snooze the alarm

- When the alarm sounds, select **Snooze** to stop the alarm for a certain time period.

To turn off the alarm

- When the alarm sounds, select **Stop.**

To remove an alarm

- 1 Select **Menu > Organiser > Clock > Alarms.**
- 2 Select an alarm and select **Options > Delete alarm.**

To set the alarm tone

- 1 Select **Menu > Settings > Phone > Date and time > Clock alarm signal.**
- 2 Select an option.

To set the alarm snooze time

- 1 Select **Menu > Settings > Phone > Date and time > Alarm snooze time.**
- 2 Set a time between 1 and 60 minutes and select **OK.**

World Clock

You can view the current time at different locations around the world.

To add a location

- 1 Select **Menu > Organiser > Clock > World clock > Options > Add location.**
- 2 Select an option.

To set a current location

- Select a location, and select **Options > Set as current location.**

Calendar

To add a new entry

- 1 Select **Menu > Calendar.**
- 2 Select a date.
- 3 Select **Options > New entry.**
- 4 Select an option.

To delete an entry

- 1 Select a date, and select an entry.
- 2 Select **Options > Delete.**
- 3 Select **Yes.**

To change view in calendar

- 1 When the calendar is open, select **Options > Change view.**
- 2 Select an option.

To select a date

- 1 When the calendar is open, select **Options > Go to date.**
- 2 Enter a date and select **OK.**

To set the calendar alarm tone

- 1 When the calendar is open, select **Options** > **Settings** > **Calendar reminder signal**.
- 2 Select an option.

Google™

You can search various content, such as websites or images by Google.

Before you use Google

When you use Google for the first time, you need to confirm some information such as Terms of Service and country. If you cannot use the Internet, see *I cannot use Internet-based services* on page 69.

To start a search

- 1 Select **Menu** > **Organiser** > **Google**.
- 2 Enter your search text in the search field.

To view more Google info

- 1 Select **Menu** > **Organiser** > **Google**.
- 2 Tap ⓘ.

To change settings in Google

- 1 Select **Menu** > **Organiser** > **Google**.
- 2 Tap ⚙ and select the settings you want to change.

Notes

You can make notes and save them.

To add a note

- 1 Select **Menu** > **Organiser** > **Notes** > **Options** > **New note**.
- 2 Write a note and select **Done**.

To delete a note

- 1 Select **Menu** > **Organiser** > **Notes**.
- 2 Select a note.
- 3 Select **Options** > **Delete**.

To send a note

- 1 Select **Menu** > **Organiser** > **Notes**.
- 2 Select a note.
- 3 Select **Options** > **Send**, and select a transfer method.

Converter

You can convert measures from one unit to another. The converter has limited accuracy, and rounding errors may occur.

To use the converter

- 1 Select **Menu** > **Organiser** > **Converter**.
- 2 Select **Type** and select an option.
- 3 Select the first **Unit** and select a unit from which you want to convert.
- 4 Select the second **Unit** and select a unit to which you want to convert.
- 5 Select the first **Amount** and enter the value. The other **Amount** will show the converted value.

Calculator

The calculator has limited accuracy and is designed for simple calculations. Rounding errors may occur.

To use the calculator

- Select **Menu > Organiser > Calculator**.

Adobe™ PDF

You can read PDF (Portable Document Format) documents using Adobe™ Reader.

- 💡 **Adobe PDF** is a trial application. You need to buy a licence if you want to use the application after the trial expires.

To view a PDF document

- 1 Select **Menu > Organiser > Adobe PDF**.
- 2 Select a folder.
- 3 Select a PDF document.

To zoom a PDF document

- When you open a PDF document, select  or .

To search text in a PDF document

- 1 When you open a PDF document, select **Options > Find**.
- 2 Enter a search string and select **Find**.

Quickoffice™

You can read and edit Microsoft® Word, Microsoft® Excel® and Microsoft® PowerPoint® documents as well as text-only documents.

- 💡 You need to buy a licence for Quickoffice before you can use the program.

To open Quickoffice

- Select **Menu > Organiser > Quickoffice**.

Search

You can search for items such as contacts, files, folders and calendar entries in your phone.

To search for items

- 1 Select **Menu > Organiser > Search**.
- 2 Enter a search phrase and select **Search**.

RoadSync™

RoadSync™ uses the Microsoft® Exchange ActiveSync® protocol to provide secure, wireless and direct push synchronisation of information. With RoadSync in your phone, you can wirelessly synchronise emails and subfolders, calendar items, contacts, tasks and attachments.

RoadSync saves its data in the applications on your phone. Email messages are saved in **Messaging** (in a separate RoadSync mailbox), calendar items are saved in **Calendar**, and contacts are saved in **Contacts**.

- 💡 For more information in your phone, select **Menu > Organiser > Help > RoadSync Help**.

Before you set up RoadSync™

- ! Before setting up RoadSync, you have to set up an Internet account in your phone. See *Internet* on page 46 for more information or ask your IT department (if you are a corporate user) or your operator which settings to use for your Internet and RoadSync accounts.

To set up a RoadSync™ account

- 1 Select **Menu** > **Organiser** > **RoadSync**.
 - 2 Select **Next** and follow the instructions on the screen.
- ! To get help, select **Options** > **Help**.

Synchronisation errors

If you experience synchronisation problems, or general problems with the RoadSync application, perform the following actions:

- Check the log. In the log you can find information to help you check the settings or connections.
- Restart the phone.
- Reset all data in RoadSync.

Working offline

You can use your phone to work offline when no service is available. For example, you can still use your phone in flight mode, on a plane, to write and send email messages to contacts that are available in your phone.

As soon as you connect to a network after the flight, RoadSync will automatically send all email messages that are in your Outbox. Your Exchange server email will also be updated automatically, and this will be reflected on your PC.

If you lose your phone

If your phone is lost or stolen, immediately report the loss to your IT department if you are a corporate user. Your IT department can do a remote wipe of synchronised data on the phone.

If you synchronise with a public exchange server, contact the relevant support service.

Applications

PlayNow™ application

When you select the **PlayNow™** application, you enter PlayNow™ online service, where you can download music, games, ringtones, themes and wallpapers. You can preview or listen to content before you purchase and download it to your phone.

- ! This service is not available in all countries.

For extended functionality, you can also access the PlayNow™ web shop on a computer from www.playnow-arena.com. For more information, go to www.sonyericsson.com/support.

- 💡 Before you use the PlayNow™ application, you must have the required Internet connection settings in your phone.

To use the PlayNow™ application

- 1 Select **Menu** > **PlayNow™**.
- 2 Search through the PlayNow™ online service and follow the instructions to preview and purchase content.

Downloading from PlayNow™ web shop

The price appears when you select to download and save a music file. Your phone bill or prepaid card is debited when a purchase is accepted.

To download a music file you have purchased

- 1 Select the music you want to buy.
- 2 Select **Yes** to download.
- 3 When the payment is successfully completed, you can listen to the music file.

Radio

- ! Do not use your phone as a radio in places where this is prohibited.

To turn on the radio

- 1 Connect a handsfree to your phone.
- 2 Select **Menu > Applications > Radio**.

To search for channels automatically

- Select **Menu > Radio > Auto tune up**.
- 💡 To search for channels automatically, you can also select **Auto tune down**.

To search for channels manually

- Select **▲** or **▼**.

To adjust the volume

- Press the volume key up or down.

To minimise the radio

- Select **Options > Play in background**.

To return to the radio

- Select **Menu > Radio**.

To save channels manually

- 1 When you have found a radio channel, select **Options > Save station**.
- 2 Select a position, enter the new name and select **OK**.

To switch between saved channels

- Select **▶** or **◀**.

TrackID™ application

The TrackID™ application is a music recognition service. You can search for the title, artist and album name of a track you hear playing through a loudspeaker.

- 💡 Before you use the TrackID™ application, you must have the required Internet connection settings in your phone.

To search for track information

- When you hear a track through a loudspeaker outside your phone, select **Menu > Applications > TrackID™ > Start**.

- 💡 For best results, use the TrackID™ application in a quiet area.

- 💡 You get a vibrating alert when the recording is finished or if the recording fails.

Voice recorder

You can record a voice memo. Recorded sounds can also be set as ringtones.

To record a sound

- 1 Select **Menu > Applications > Record sound > Options > Record sound clip**.
- 2 Select **Stop** to finish a recording.

To listen to a recording

- 1 Select **Menu > Organiser > File mgr. > Phone memory > Sound files > Digital sounds**.
- 2 Select a recording and then select **Options > Open**.

Conversations

You can choose whether to view your messages in **Conversations** or **Inbox**. A messaging conversation shows all messaging communication between you and one of your contacts.

To view messages in Conversations

- Select **Menu** > **Applications** > **Conversations**.

To send a message from Conversations

- 1 Select **Menu** > **Applications** > **Conversations**.
- 2 Select a conversation.
- 3 Write a message and select **Send**.

Transferring and handling content

You can transfer and handle your content such as pictures and music.

- ! You are not allowed to exchange some copyright-protected material.

Using a USB cable

You can connect your phone to a computer using a USB cable to synchronise, transfer and back up phone content, and to use your phone as a modem.

Required operating systems

You need one of these operating systems to use Sony Ericsson PC software:

- Microsoft® Windows Vista™
- Microsoft® Windows XP, Service Pack 3 or higher

Before using a USB cable

Only use a USB cable supported by your phone. Do not remove the USB cable from your phone or computer during transfer as this may corrupt the memory card or the phone memory.

To use mass storage

- 1 Connect the USB cable to the phone and the computer.
- 2 **Phone:** Select **Mass storage**.
- 3 **Computer:** Wait until your memory card appears as the external disk in *Microsoft® Windows® Explorer*.
- 4 **Computer:** On the computer desktop, double-click the *My Computer* icon.
- 5 **Computer:** To view the memory card folders, double-click the icon representing your memory card.
- 6 Copy and paste your file, or drag and drop it, into a folder on your computer or on your memory card.

- ! You cannot view the transferred files in your phone until you remove the USB cable from the phone.

PC Companion

PC Companion lets you:

- Explore content in your phone.
- Use your phone as a modem.
- Install PC Software used to synchronise, transfer and back up phone content. For more information, go to www.sonyericsson.com/support.

To install PC Companion

- 1 Connect your phone to a PC using a USB cable supported by your phone.
- 2 **Computer:** Select **Mass storage**.
- 3 **Computer:** Wait until the memory card in your phone appears as the external disk in *Microsoft® Windows® Explorer*.
- 4 **Computer:** On the computer desktop, double-click the *My Computer* icon.
- 5 **Computer:** To launch the PC Companion installer from the memory card, double-click the icon representing your memory card and double-click **Startme.exe** under the folder **pccompanion**.
- 6 **Computer:** Follow the instructions that appear.

Sending content to another phone

You can send content, for example, using **Messaging** or using Bluetooth™ wireless technology.

Using Bluetooth™ wireless technology

The Bluetooth™ function is free of charge and makes wireless connections to other Bluetooth devices possible. You can, for example:

- Connect to handsfree devices.
 - Connect to several devices at the same time.
 - Connect to computers and access the Internet.
 - Exchange items.
 - Play multiplayer games.
- ! A range within 10 metres (33 feet), with no solid objects in between, is recommended for Bluetooth communication.

Phone name

You can enter a name for your phone that is shown to other devices using Bluetooth wireless technology.

To enter a phone name

- 1 Select **Menu > Settings > Connectivity > Bluetooth > Phone name**.
- 2 Enter the phone name and select **OK**.

Visibility

If you want other Bluetooth devices to be able to detect your phone, you can choose to make your phone visible.

To show your phone

- 1 Select **Menu > Settings > Connectivity > Bluetooth > Phone visibility**.
- 2 Double-tap **Visible** or **Set visibility period**.

To hide your phone

- 1 Select **Menu > Settings > Connectivity > Bluetooth > Phone visibility**.
- 2 Double-tap **Hidden**.

Before using Bluetooth wireless technology

You must turn on the Bluetooth function to communicate with other devices. You may also have to pair your phone with other Bluetooth devices.

To turn on the Bluetooth function

- Select **Menu > Settings > Connectivity > Bluetooth > Bluetooth > On**.
- ! Make sure that the device you want to pair your phone with has the Bluetooth function activated and Bluetooth visibility turned on.

To pair your phone with another device or a Bluetooth handsfree

- 1 Select **Menu** > **Settings** > **Connectivity** > **Bluetooth**.
- 2 Tap .
- 3 Tap **Options** > **New paired device**.
- 4 Select a device.
- 5 Enter a passcode, if required.

To receive an item

- 1 Select **Menu** > **Settings** > **Connectivity** > **Bluetooth** > **Bluetooth** > **On**.
- 2 When you receive an item, follow the instructions that appear.

To block a paired device

- 1 Select **Menu** > **Settings** > **Connectivity** > **Bluetooth**.
- 2 Tap .
- 3 Tap a device from the list.
- 4 Tap **Options** > **Block**.
- 5 Select an option.

To delete a blocked device

- 1 Select **Menu** > **Settings** > **Connectivity** > **Bluetooth**.
- 2 Tap .
- 3 Tap a device from the list.
- 4 Tap **Options** > **Delete**.
- 5 Select an option.

Updating your phone

You can update your phone to the most recent software for optimal performance and to get the latest enhancements. You need a USB cable and an Internet-connected PC.

To learn how, go to www.sonyericsson.com/update.

-  Remember to back up your phone content before updating. See *Backing up and restoring* on page 48.

Updating your phone using Sony Ericsson PC Suite

You can update your phone using a USB cable and *Sony Ericsson PC Suite*. When the phone is connected, it will automatically check for and notify you of new updates.

Connectivity

You can connect your phone to the Internet, to other compatible devices or to computers.

Wi-Fi™

Using Wi-Fi™ you can access the Internet wirelessly with your phone. You can browse the Internet at home (personal networks) or in public access zones (hot spots):

- Personal networks – usually protected. A pass phrase or a key is required from the owner.
- Hot spots – usually non-protected but often requires you to log on to the operator's service before you get Internet access.

Using Wi-Fi

To be able to browse the Internet using Wi-Fi, you need to search for and connect to an available network and then open the Internet browser.

To connect to a network

- 1 Select **Menu** > **Settings** > **Connectivity** > **Wi-Fi**.
- 2 Tap a network and select **Options** > **Connect**.
- 3 Enter a key, if required.

To start browsing using Wi-Fi

- 1 Select **Menu > Settings > Connectivity > Wi-Fi**.
- 2 Tap a network and select **Options > Start browsing**.
- 3 Enter a key, if required.

Media Server

Your phone has a built-in DLNA™ (Digital Living Network Alliance) media server functionality that connects to your home network through Wi-Fi™. Other home network client devices connected to the same home network can access, view and play images and music saved in your phone. A client device can be, for example, a computer, camera, TV, PLAYSTATION®3 which DLNA™ certified.

Note: **Wi-Fi™** must be turned on and the phone must be connected to your wireless home network.

Before using Media Server

Before using **Media server**, you need a Wi-Fi™ network in your vicinity, and a computer with client software or another client device.

To set your phone as a media server

- 1 Select **Menu > Applications > Media serv..**
 - 2 Edit the **Phone name** if needed.
 - 3 Select **Start**.
 - 4 Select the Wi-Fi™ network that you want to connect to.
 - 5 Enter the WEP key.
 - 6 **Server running** appears on the screen. Your phone can now work as a media server.
 - 7 To minimize the **Media server**, select **Hide**. **Media server** keeps running in the background.
 - 8 To stop the server, go to the **Media server** view and select **Stop**.
- ! Phone name changes and media content updates are not reflected on client devices while the media server is running. In order to reflect such changes on client devices, stop and restart the media server.

To use the Media server application

- 1 Activate client software installed on your computer.
 - 2 If you also have client devices such as PLAYSTATION®3, turn on the client devices within your wireless network.
 - 3 Set your phone as a media server. After searching the network, the client devices will find your phone and show all possible servers in your wireless network.
 - 4 Select your Sony Ericsson phone as the server.
 - 5 Transfer to and show your phone content on client devices. It may take a couple of minutes to show all the content on the client devices if many photo or music files are saved on the phone.
- ! These instructions may differ between client devices. See also your client device User guide. If the device cannot connect, check if your home network is working.
- ! Wi-Fi networks may be accessible by others. If you have concerns with the security of your information and use of devices over a wireless network, please verify security settings of the wireless network selected.
- ! Only thumbnail images in JPEG format are supported. Thumbnail images are not shown when the memory card is not inserted or when it is full.

Access points

You need to define access points used for your phone to connect to a network destination. You can, for example, create access points for **Internet** to browse the web, and create access points for **Multimedia msg** to send and receive multimedia messages.

- ! You can receive access point settings in a message from your service provider. Some or all access points may be predefined in your phone by your service provider, and you may not be able to change, create, edit or remove them.

To create a new access point

- 1 Select **Menu > Settings > Connectivity > Destinations > Access point**.
- 2 Follow the instructions that appear to check for the available access points automatically or define them manually.

To check for access points automatically

- 1 Select **Menu > Settings > Connectivity > Destinations > Access point**.
- 2 When **Automatically check for available access points?** appears, select **Yes**.
- 3 Select an access point. Enter a key, if required.
- 4 Select a network destination.

To define a packet data access point

- 1 Select **Menu > Settings > Connectivity > Destinations > Access point**.
- 2 When you are asked to check for available access points automatically, select **No**.
- 3 Select **Packet data** as the access point.
- 4 Enter a name and select **OK**.
- 5 Select a network destination.

Synchronising

You can synchronise in two different ways. You can synchronise your phone using a computer program or you can synchronise using an Internet service.

- 💡 Use only one of the synchronisation methods at a time with your phone.

Synchronising using a computer

Using a computer, you can synchronise contacts, appointments, bookmarks, tasks and notes saved on your phone with data saved in a program such as Microsoft® Outlook®. You need to use a USB cable or Bluetooth wireless technology to transfer the data between your phone and the computer.

Before synchronising, you need to install the *Sony Ericsson PC Suite*, which is available for download through PC Companion or from www.sonyericsson.com/support.

- 💡 To download Mac-compatible software, go to www.sonyericsson.com/support.

To synchronise using the Sony Ericsson PC Suite

- 1 **Computer:** Start *Sony Ericsson PC Suite* from *Start/Programs/Sony Ericsson/Sony Ericsson PC Suite*.
- 2 Follow the instructions in the *Sony Ericsson PC Suite* on how to connect.
- 3 When you are notified that the *Sony Ericsson PC Suite* has found your phone, you can start synchronising.

- 💡 For usage details, see the *Sony Ericsson PC Suite* Help section once the software has been installed on your computer.

Synchronising using an Internet service

You can use SyncML™ protocol to synchronise data on your phone with data stored online by an Internet synchronisation service. You can also use Microsoft Exchange ActiveSync protocol to synchronise data on your phone with data saved on a Microsoft Exchange Server.

Synchronisation profiles

You can create synchronisation profiles to save your synchronisation settings.

To create a new synchronisation profile

- 1 Select **Menu** > **Settings** > **Connectivity** > **Data transfer** > **Sync**.
- 2 Tap **Options** > **New sync profile** > **Start**.
- 3 Follow the instructions that appear.

Settings

You can change some settings in your phone. You can follow the **Setup wizard** for basic settings, tips and tricks.

-  Some settings may be preset by your service provider, and you may not be able to change them.

To use the setup wizard

- Select **Menu** > **Organiser** > **My applications** > **Setup**.

Personal settings

You can personalise your phone by changing the standby screen, profile or themes.

Profiles

You can change settings such as the ring volume and vibrating alert to suit different locations. You can create new profiles or change preset profiles.

To change the profile

- 1 Select **Menu** > **Settings** > **Personal** > **Profiles**.
- 2 Tap a profile and select **Activate**.
- 3 Select **Back**.

-  You can also press ① and then select a profile.

To edit a profile

- 1 Select **Menu** > **Settings** > **Personal** > **Profiles**.
- 2 Tap a profile and select **Personalise**.
- 3 Change the settings and select **Back**.

To create a new profile

- 1 Select **Menu** > **Settings** > **Personal** > **Profiles**.
- 2 Select **Options** > **Create new**.
- 3 Enter the settings and select **Back**.

Flight mode

In **Flight mode** the network and radio transceivers are turned off to prevent disturbance to sensitive equipment.

To turn on flight mode

- Press ① and select **Flight mode**.

Themes

You can personalise your phone by using themes. Themes control, for example, the colour of the screen and the text, the layout of menus, and the wallpaper.

To set themes

- 1 Select **Menu > Settings > Personal > Themes**.
 - 2 Change the settings:
 - **General** – view or change the theme used for all applications that do not have their own themes, or download more themes to your phone.
 - **Menu** – change the appearance of applications in **Menu**.
 - **Standby theme** – change the appearance of the standby screen.
 - **Wallpaper** – change the background for the standby screen.
 - **Call picture** – display a picture on your screen for your outgoing calls.
 - 3 To save your changes, select **Back**.
- ! Available options may vary with your standby theme.



To change the standby screen appearance

- 1 Select **Menu > Settings > Personal > Standby**.
- 2 Change the settings:
 - **Shortcuts** – add shortcuts for applications or bookmarks to the standby screen.
 - **Standby theme** – change the appearance of the standby screen.
- 3 To save your changes, select **Back**.

Standby screen

You can change how the standby screen looks and add application shortcuts to the standby screen.

To use shortcuts from standby

- 1 To go to standby, press .
 - 2 To access the shortcuts view, tap .
 - 3 Select a shortcut.
- ! The shortcuts view is available only when **Sony Ericsson** is selected as the default theme for the standby screen. See *To set themes* on page 60.

Phone settings

You can change the date, time and phone language, or define settings for your applications.

Date and time

You can set your time zone, current time and date, and choose the formats and separators for time and date. When you travel across time zones, you can let your phone update the time and date automatically.

To set date and time

- 1 Select **Menu > Settings > Phone > Date and time**.
- 2 Change the settings and select **Back**.

To set your time zone

- 1 Select **Menu > Settings > Phone > Date and time > Time zone**.
- 2 Select your country or region.
- 3 Select **Back**.

To turn on automatic time update

- Select **Menu > Settings > Phone > Date and time > Automatic time update > On**.

 **Automatic time update** may not be available in all networks.

To change the alarm settings

- 1 Select **Menu > Settings > Phone > Date and time**.
- 2 To change the alarm signal, select **Clock alarm signal**.
- 3 To change the alarm snooze time, select **Alarm snooze time**.
- 4 To save your settings, select **Back**.

Languages

You can change your phone language and writing language.

To change the phone language

- 1 Select **Menu > Settings > Phone > Language > Phone language**.
- 2 Select an option and select **Back**.

To change the writing language

- 1 Select **Menu > Settings > Phone > Language > Writing language**.
- 2 Select an option and select **Back**.

Display

You can change the contrast, font size and backlight time-out period for your screen.

To change the screen settings

- 1 Select **Menu > Settings > Phone > Display**.
- 2 Change settings:
 - **Font size** – change the size of text and icons on the screen.
 - **Welcome note / logo** – to display a note or a picture when you turn on the phone, select **Text** or **Picture**.
 - **Light timeout** – set how long the backlight stays on when you stop using the phone.

Downloading settings

You can download settings for your email accounts, multimedia messages and Internet access.

-  You can also download settings from www.sonyericsson.com/support.

To download settings

- 1 From **Menu > Settings > Phone > Download settings**.
- 2 To download settings for your email, select **Email**.
- 3 To download Internet settings, select **Internet & MMS**.
- 4 Follow the instructions.

Sensor settings

Your phone sensors. When the sensors are on, you can control several functions, for example, mute incoming calls and snooze alarms, by turning your phone upside down. This feature is called turning control.

To turn on sensors

- Select **Menu > Settings > Phone > Sensor settings > Sensors > On**.

To use the turning control

- 1 Select **Menu > Settings > Phone > Sensor settings > Turning control**.
- 2 Select the events you want to use turning control for:
 - **Snoozing alarms** – to snooze a ringing alarm, turn the phone upside down.
 - **Silencing calls** – to mute an incoming call, turn the phone upside down.
 - **Auto-rotate display** – rotate the screen content automatically to fit the screen orientation (vertical or horizontal).

-  Not all applications support turning control.

Touch input

You can change settings for handwriting recognition, such as the writing speed and the thickness of the text written with the stylus.

To change touch input settings

- 1 Select **Menu > Settings > Phone > Touch input**.
- 2 Change the settings:
 - **Handwriting training** – train the phone to recognise your handwriting.
 - **Writing language** – define which language-specific characters in your handwriting are recognised and define the layout of your on-screen keyboard.
 - **Writing speed** – adjust the speed at which handwriting is recognised.
 - **Guiding line** – show or hide the guiding line in the handwriting area.
 - **Pen trail width** – change the thickness of the text you write using the stylus.
 - **Writing colour** – change the colour of the text you write using the stylus.
 - **Touch screen calibration** – calibrate your screen.

 These options may not be available in all languages.

Accessories

You can change the accessory settings, for example, change which phone profile to use when a certain accessory is connected to the phone.

To change accessory settings

- 1 Select **Menu > Settings > Phone > Accessories**.
- 2 Select an accessory and change its settings.
- 3 To save your changes, select **Back**.

Application settings

You can enter settings for some applications.

Messaging settings

The messaging settings may be preset in your phone, or you may receive them in a message.

 Some or all message centres or access points may be preset for your phone by your service provider, and you may not be able to change, create, edit, or remove them.

To edit messaging settings

- 1 Select **Menu > Messaging**.
- 2 Select **Options > Settings**.
- 3 To edit settings for different message types, select the message type.
- 4 To save your changes, select **Back**.

Text message settings

To edit text message settings

- 1 Select **Menu > Messaging**.
- 2 Select **Options > Settings > Text message**.
- 3 The following settings are available:
 - **Message centres** – view a list of all text message centres that have been defined.
 - **Message centre in use** – select which message centre to use to deliver text messages.
 - **Character encoding** – select **Full support** to prevent automatic character conversion to another encoding system or **Reduced support** to use conversion, when available.
 - **Receive report** – select if the network should send delivery reports for your messages. This feature is network-dependant.
 - **Message validity** – select for how long the message centre attempts to resend your message if the first attempt fails. If the message cannot be sent within the validity period, the message is deleted from the message centre.
 - **Message sent as** – select whether your text messages are sent in text, fax or paging format.
 - **Preferred connection** – select a connection to use.
 - **Reply via same centre** – select whether you want the reply message to be sent using the same text message centre number.

Multimedia message settings

To configure multimedia message settings

- 1 Select **Menu > Messaging**.
- 2 Select **Options > Settings > Multimedia message**.
- 3 Select from the following:
 - **Picture size** – define the size of the picture in a multimedia message.
 - **Mms creation mode** – **Guided**: the phone informs you if you try to send a message that may not be supported by the recipient. **Restricted**: the phone prevents you from sending messages that may not be supported. **Free**: include content in your messages without notifications.
 - **Access point in use** – select which access point is used as the preferred connection.
 - **Multimedia download** – to download new multimedia messages automatically, select **Always automatic**. Sending and receiving multimedia messages from outside your home network may incur additional costs.
 - **Allow anon. messages** – select whether you want to reject messages from an anonymous sender.
 - **Receive adverts** – select whether you want to receive multimedia message advertisements.
 - **Receive report** – select whether you want the status of a sent message to be shown in the log.
 - **Deny report sending** – select whether you want to prevent your phone from sending delivery reports of received messages.
 - **Message validity** – select for how long the message centre attempts to resend your message if the first attempt fails. If the message cannot be sent within this time period, the message is deleted from the message centre.

Email settings

To manage mailboxes

- 1 Select **Menu > Messaging**.
- 2 Select **Options > Settings > Email > Mailboxes**.
- 3 Select **Options** and select an option.

To create a new mailbox

- 1 Select **Menu** > **Messaging**.
- 2 Select **Options** > **Settings** > **Email**.
- 3 Select **Mailboxes** > **Options** > **New mailbox**.

! When you name your new mailbox, the default mailbox in the main **Messaging** view is renamed accordingly.

To remove a mailbox and its contents from your phone

- 1 Select **Menu** > **Messaging**.
- 2 Select **Options** > **Settings** > **Email**.
- 3 Select **Mailboxes**.
- 4 Tap the mailbox you want to remove.
- 5 Select **Options** > **Delete**.

Cell broadcast settings

With the cell broadcast service (CBS), you can receive informative messages from your service provider on various topics, such as weather or traffic conditions in a particular region.

To configure cell broadcast settings

- 1 Select **Menu** > **Messaging**.
- 2 Select **Options** > **Settings** > **Cell broadcast**.
- 3 Select options from the following:
 - **Reception** – to receive cell broadcast messages, select **On**.
 - **Language** – to receive cell broadcast messages in every available language, select **All**. To choose specific languages, select **Selected**. If you cannot find the desired languages, select **Other**.
 - **Topic detection** – to display new topics in the cell broadcast topic list, select **On**.

To change other messaging settings

- 1 Select **Menu** > **Messaging**.
- 2 Select **Options** > **Settings** > **Other**.
- 3 Select from the following:
 - **Save sent messages** – to save copies of messages you send in the Sent messages folder, select **Yes**.
 - **Number of saved msgs** – to set how many sent messages are saved, enter a number. The default limit is 20. When the limit is reached, the oldest message is replaced by the newest saved message.
 - **Memory in use** – to select the memory used to save received messages, select **Phone memory** or **Memory card**.
 - **Show messages in groups** – view your messages in groups.
 - **Show email in groups** – view your email messages in groups.
- 4 To save your changes, select **Back**.

Phone management

You can update your phone software, improve your phone security with automatic keylock and certificates, or reset your phone to its factory settings.

Phone and SIM card

To access phone and SIM card security settings

- 1 Select **Menu > Settings > Phone > Phone management > Security > Phone and SIM card**.
 - 2 You can select from the following:
 - **PIN code request** – when active, the PIN code is requested each time the phone is turned on. Turning off the PIN request may not be allowed by some SIM cards.
 - **PIN code** and **PIN2 code** – change the PIN and PIN2. These codes can only include numbers.
 - **Phone autolock period** – to avoid unauthorised use, you can set a time-out after which the phone automatically locks. A locked phone cannot be used until the correct lock code is entered.
 - **Lock code** – the lock code is used to unlock the phone. You can change the lock code to avoid unauthorised use of your phone. The default code is 0000. The new code can be four to eight characters long. The phone notifies you if the lock code is not properly formatted. Keep the new code secret and separate from your phone.
 - **Lock if SIM card changed** – set the phone to ask for the lock code when an unknown SIM card is inserted.
 - **Remote phone locking** – enable or disable remote lock.
 - **Confirm SIM services** – set the phone to display confirmation messages when you are using a SIM card service.
- ! Avoid using access codes similar to emergency numbers to prevent accidental dialling of an emergency number. If you forget the PIN code, the PIN2 code or the lock code, contact your service provider.
- ! The option **Confirm SIM services** is dependent on your network. For more information, see *To use remote phone locking* on page 67.

Certificate management

Digital certificates should be used if you want to connect to an online bank, another site or a remote server for actions that involve transferring confidential information. They should also be used if you want to reduce the risk of viruses or other malicious software and be sure of the authenticity of software when downloading and installing software.

To access certificate management

- 1 Select **Menu > Settings > Phone > Phone management > Security > Certificate management**.
 - 2 You can select from the following:
 - **Authority certificates** – view and edit authority certificates.
 - **Trusted site certificates** – view and edit trusted site certificates.
 - **Personal certificates** – view and edit personal certificates.
 - **Phone certificates** – view and edit phone certificates.
- ! Certificates must be used correctly in order to benefit from increased security. The existence of a certificate does not offer any protection by itself; the certificate manager must contain correct, authentic, or trusted certificates for increased security to be available. Certificates have a restricted lifetime. If they expired or become invalid, check the current date and time in your phone.

Protected content

You can select whether providers of usage-right protected media files are allowed to track transfers and transactions of such files.

To access protected content

- Select **Menu > Settings > Phone > Phone management > Security > Protected content**.

Security module

To access security module information

- 1 Select **Menu > Settings > Phone > Phone management > Security > Security module**.
- 2 To view or edit a security module, if available, select the security module from the list.

Locks

SIM card lock

This lock only protects your subscription. Your phone will work with a new SIM card. If the lock is on, you have to enter a PIN.

The PIN2 is required to access some network services, and your SIM card must support these services.

If you enter your PIN incorrectly three times in a row, the SIM card is blocked and you need to enter your PUK (Personal Unblocking Key). Your PIN, PIN2 and PUK are supplied by your network operator.

To unblock your SIM card

- 1 When **PIN blocked. Enter PUK:** appears, enter your PUK and select **OK**.
- 2 Enter a new four-to-eight-digit PIN and select **OK**.
- 3 Re-enter the new PIN and select **OK**.

To turn on the SIM card lock

- 1 Select **Menu > Settings > Phone > Phone management > Security > Phone and SIM card > PIN code request > On**.
- 2 Enter your PIN and select **OK**.

To edit your PIN

- 1 Select **Menu > Settings > Phone > Phone management > Security > Phone and SIM card > PIN code**.
- 2 Follow the instructions to enter your old PIN once and new PIN twice.

To edit your PIN2

- 1 Select **Menu > Settings > Phone > Phone management > Security > Phone and SIM card > PIN2 code**.
- 2 Follow the instructions to enter your old PIN2 once and new PIN2 twice.

Phone lock

You can stop unauthorised use of your phone. The default phone lock code is 0000. You can change the phone lock code to any four-to-eight-digit personal code.

When the touch screen and keys are locked, the touch screen and the keys are inactive.

- ! It is important that you remember your new code. If you forget it, you need to take your phone to your local Sony Ericsson retailer.

To turn on the phone lock

- 1 Select **Menu > Settings > Phone > Phone management > Security > Phone and SIM card > Phone autolock period > User defined**.
- 2 To automatically lock your phone when you do not use it for a defined time, tap the text input field under **Lock after (minutes):** and enter the time-out period.
- 3 Enter your phone lock code and select **OK**.
- 4 To unblock the phone, press  and follow the instructions that appear.

To edit your phone lock code

- 1 Select **Menu > Settings > Phone > Phone management > Security > Phone and SIM card > Lock code.**
- 2 Follow the instructions to enter your old lock code once and your new lock code twice.

Remote phone locking

You can lock your phone remotely and prevent its unauthorised use by defining and sending a text message (5-20 characters) from another phone to your phone. You need the phone lock code to unlock your phone.

To use remote phone locking

- 1 Select **Menu > Settings > Phone > Phone management > Security > Phone and SIM card > Remote phone locking > Enabled.**
- 2 Tap the text input field under **Remote locking message:** and define your message content. Verify the message and enter the phone lock code.
- 3 To lock your phone, send the remote locking message from another phone using SMS, and your phone is immediately locked. The sending phone will receive a message confirming the lock.

Factory settings

You can reset your phone settings to the factory settings. Documents and files are not affected by this reset.

To restore factory settings

- 1 Select **Menu > Settings > Phone > Phone management > Default settings > Yes.**
- 2 Enter the lock code. The phone restarts.

Application manager

You can install .sis, .sisx and Java applications, or applications downloaded from the Internet or received from other compatible devices. In **Application manager**, you can install software applications saved in your phone, view details of installed applications, remove applications or define installation settings.

- ! Only install applications from trusted sources, such as applications that are Symbian-signed or have passed the Java-verified testing.

To configure installation settings

- Select **Menu > Settings > Application manager > Installation settings.**

To send installation files

- 1 Select **Menu > Settings > Application manager > Installed applications.**
- 2 Select an application.
- 3 Select **Options > Send** and select a transfer method.

- 💡 You may not be allowed to send licenced installation files to other devices.

To uninstall applications

- 1 Select **Menu > Settings > Application manager > Installed applications.**
- 2 Select an application and then select **Options > Uninstall.**

Troubleshooting

This chapter is all about solving possible problems with your phone. To find further suggestions, go to www.sonyericsson.com/support. Select your region, country and phone model to find helpful information.

Your phone also includes help texts. In many applications and in some dialog windows, for example, those where you enter important settings, **Help** is available in the **Options** menu.

To improve performance, you can update the software in your phone. See *Updating your phone* on page 56.

- ! If you need to hand in your phone for repair, note that you may lose any information and content that you have saved in your phone. You are advised to make a copy of such information using PC Companion. See *PC Companion* on page 54.

Start-up problems

If the phone does not start, you could:

- Recharge or replace the battery. Avoid charging the battery in extreme temperatures.
- Clean the contacts on the battery and in the phone.

Lock problems

Inserting the SIM card

Make sure a SIM card is activated and inserted into your phone. See *SIM card* on page 4.

Keys and screen lock

Your phone screen and keys may have been locked. The screen and keys can be locked to prevent unintentional key actions. To unlock, press  and follow the instructions that appear. See *Automatic keylock and screen guard* on page 8.

Blocked SIM card

If your PIN is entered incorrectly three times in a row, the SIM card will be blocked. You can unblock it by using your PUK. See *SIM card lock* on page 66.

Phone lock

You can lock your phone to prevent unauthorised use. See *Phone lock* on page 66.

Indicator light

The indicator light can light or flash in green or red.

- **Flashes green** – you have, for example, received a new message or missed a call.
- **Flashes red** – the battery is running low and you need to recharge it soon or replace it with a spare battery.
- **Green light** – the phone is fully charged.
- **Red light** – the phone is being charged.

Communication problems

The phone does not work

- The received signal can be too weak, possibly because you are being shielded from the signal. Check the signal strength indicator on your phone display. Move outdoors or to higher ground to get a sufficiently strong signal.
- Make sure the phone is not set to **Flight mode**.
- Check the settings for diverting or restricting calls. See *Diverting calls* on page 14 and *Restricted dialling* on page 16.
- If **Emergency calls only** is displayed on the screen, you are not allowed to use the network within range but you can make an emergency call using the emergency number.
- You may be in an area that is not covered by a network, or where the received signal is too weak.

Cannot hear incoming calls

- The ring volume is too low. Increase the volume.
- Your phone is set to **Silent** mode.
- Your phone is set to **Flight mode**.
- The sound is transferred to a Bluetooth headset or a regular headset.

The person I am talking to cannot hear what I am saying

- Make sure you do not cover the microphone when you talk. The microphone is at the bottom of the phone.
- Make sure you have not muted the microphone. To unmute the phone, select **Unmute**.
- You could be almost out of network range. The sound improves with a better network connection.

Cannot send or receive text messages or multimedia messages

- Your subscription does not include text or multimedia messages. Check with your service provider.
- Check with your service provider that you have entered the correct Service Centre phone number.
- Check your messaging settings. Contact your service provider or go to www.sonyericsson.com/support for more information.
- Make sure that **Flight mode** is off.
- The phone memory may be full. Delete, for example, some pictures or music.

Cannot use email

- Check with your service provider that your subscription includes email.
- The settings may not be correct. Enter new settings. Use the phone setup message generator for email at www.sonyericsson.com/support to receive an auto setup message, or contact your service provider. See also *Email settings* on page 63.

I cannot use Internet-based services

Your subscription does not include data capability. Settings are missing or incorrect.

You can download settings from **Menu > Settings > Phone > Download settings > Internet & MMS** or from www.sonyericsson.com/support.

Fax calls

- Your phone does not support fax calls. Even if your operator subscription supports fax transmission, fax calls will be rejected. However, they can be diverted to another number such as the office fax number. See *Diverting calls* on page 14 for more information.
- Make sure potential fax callers do not try to send a fax to your phone, as they can experience a number of retries before the fax transmission is stopped.

Memory full

When your phone has no more space available to store information, you must then free up memory to ensure the phone works well. See *Memory* on page 5 for more information.

Problems connecting to a PC or another device

Cannot establish a connection using a USB cable

- Make sure the USB cable is connected correctly to the computer.
- Make sure the phone lock is not active.
- Uninstall Sony Ericsson PC Companion. Reinstall the program and follow the installation procedure carefully. Connect the phone to the computer.
- Check for updates of Sony Ericsson PC Companion at www.sonyericsson.com/support. If you find a new version of the program, download it and install this version to replace the old one.

Cannot transfer items using Bluetooth wireless technology

- Make sure the Bluetooth function is activated in your phone and the other device, and the visibility of the phone is turned on.
- Make sure the devices are within range of each other. A range of 10 metres (33 feet) is recommended. See *Visibility* on page 55 for more information.

Cannot establish a connection with a Bluetooth device

- Make sure the devices are correctly paired. See *Using Bluetooth™ wireless technology* on page 55.
- Make sure the devices are charged.
- Make sure the devices are within range of each other. A range of 10 metres (33 feet) is recommended.

Cannot find computer software for downloading

The latest version of Sony Ericsson PC Companion software can be downloaded from www.sonyericsson.com/support.

Cannot use my phone as a modem

- Ask your service provider to enable your data connection.
- Connect your phone to your computer using a USB cable or a Bluetooth connection.

Cannot synchronise with my computer

- Connect your phone to your computer using a USB cable or a Bluetooth connection. See *Connectivity* on page 56.
- Install Sony Ericsson PC Companion and enter the necessary settings. See *Synchronising* on page 58 and the help function in Sony Ericsson PC Companion.

Cannot see media content

If you cannot see the media content that is saved in your phone or on a memory card from the Media application, please check the maximum or minimum amount of content you are allowed to save. If the maximum storage level is exceeded for media content, try to update your media libraries manually. See *To update media libraries manually* on page 26.

Miscellaneous

Screen does not respond to touch

- You may find that you select an item, for example, a key or a menu option, but another item is activated. Calibrating the screen ensures that the correct item is activated. Run the setup wizard to calibrate the screen. See *To use the setup wizard* on page 59.

Applications do not respond

- Turn off the phone and turn it on again.
- Remove the battery, wait for about 10 seconds, and insert the battery again.
- If the problem remains, restore your phone to its factory settings. See *Factory settings* on page 67. All data will be lost.

System failure

In the case of a system failure, and if your phone does not restart automatically, press and hold down the on/off key for at least 10 seconds to turn off the phone. Then press the on/off key to turn on your phone.

Legal information

Sony Ericsson Vivaz™ phone U5i/U5a

This User guide is published by Sony Ericsson Mobile Communications AB or its local affiliated company, without any warranty. Improvements and changes to this User guide necessitated by typographical errors, inaccuracies of current information, or improvements to programs and/or equipment, may be made by Sony Ericsson Mobile Communications AB at any time and without notice. Such changes will, however, be incorporated into new editions of this User guide. All rights reserved.

©Sony Ericsson Mobile Communications AB, 2009

Publication number: 1232-6052.1

Please read the *Important information* before you use your mobile phone.

Your mobile phone has the capability to download, store and forward additional content, e.g. ringtones. The use of such content may be restricted or prohibited by rights of third parties, including but not limited to restriction under applicable copyright laws. You, and not Sony Ericsson, are entirely responsible for additional content that you download to or forward from your mobile phone. Prior to your use of any additional content, please verify that your intended use is properly licensed or is otherwise authorized. Sony Ericsson does not guarantee the accuracy, integrity or quality of any additional content or any other third party content. Under no circumstances will Sony Ericsson be liable in any way for your improper use of additional content or other third party content.

Bluetooth is a trademark or a registered trademark of Bluetooth SIG Inc. and any use of such mark by Sony Ericsson is under license.

Media Go is a trademark or registered trademark of Sony Media Software and Services.

The Liquid Identity logo, **Vivaz™**, PlayNow, TrackID and make.believe are trademarks or registered trademarks of Sony Ericsson Mobile Communications AB.

Adobe, Adobe Photoshop Album Starter Edition, Acrobat, and Reader are trademarks or registered trademarks of Adobe Systems Incorporated in the United States and/or other countries.

TrackID™ is powered by Gracenote Mobile MusicID™. Gracenote and Gracenote Mobile MusicID are trademarks or registered trademarks of Gracenote, Inc.

Sony and Media Go are trademarks or registered trademarks of Sony Corporation.

PictBridge is a trademark or registered trademark of Canon Kabushiki Kaisha Corporation.

Wi-Fi is a trademark or a registered trademark of the Wi-Fi Alliance.

DLNA is a trademark or registered trademark of the Digital Living Network Alliance.

Google™, Google Maps™, YouTube and the YouTube logo are trademarks or registered trademarks of Google, Inc.

SyncML is a trademark or registered trademark of Open Mobile Alliance LTD.

Ericsson is a trademark or registered trademark of Telefonaktiebolaget LM Ericsson.

microSD is a trademark or a registered trademark of SanDisk Corporation.

RoadSync is a trademark or registered trademark of DataViz, Inc.

Quickoffice is a registered trademark of Quickoffice, Inc.

Wisepilot is a registered trademark of Appello Systems AB.

PLAYSTATION is a trademark or registered trademark of Sony Computer Entertainment, Inc.

Twitter is a trademark or registered trademark of Twitter, Inc.

Microsoft, ActiveSync, Windows, Outlook, Excel, PowerPoint, Windows Media and Vista are registered trademarks or trademarks of Microsoft Corporation in the United States and/or other countries.

This product is protected by certain intellectual property rights of Microsoft. Use or distribution of such technology outside of this product is prohibited without a license from Microsoft.

This product is licensed under the MPEG-4 visual and AVC patent portfolio licenses for the personal and non-commercial use of a consumer for (i) encoding video in compliance with the MPEG-4 visual standard ("MPEG-4 video") or the AVC standard ("AVC video") and/or (ii) decoding MPEG-4 or AVC video that was encoded by a consumer engaged in a personal and non-commercial activity and/or was obtained from a video provider licensed by MPEG LA to provide MPEG-4 and/or AVC video. No license is granted or shall be implied for any other use. Additional information including that relating to promotional, internal and commercial uses and licensing may be obtained from MPEG LA, L.L.C. See <http://www.mpegla.com>. MPEG Layer-3 audio decoding technology licensed from Fraunhofer IIS and Thomson.

Java, JavaScript and Java-based trademarks and logos are trademarks or registered trademarks of Sun Microsystems, Inc. in the U.S. and other countries.

End-user license agreement for Sun Java Platform, Micro Edition.

1. Restrictions: Software is confidential copyrighted information of Sun and title to all copies is retained by Sun and/or its licensors. Customer shall not modify, decompile, disassemble, decrypt, extract, or otherwise reverse engineer Software. Software may not be leased, assigned, or sublicensed, in whole or in part.

2. Export regulations: Goods delivered under this Agreement may be the subject to import and export regulations of the European Union, the United States and other countries. Purchaser will comply with these applicable laws and regulations and will obtain and maintain any export and import license required for the delivery of goods to Purchaser under this Agreement. Without limiting the foregoing, and as an example, Purchaser will not knowingly export or re-export goods to destinations identified pursuant to Articles in Chapter II of European Council Regulation (EC) 428/2009 and specifically, and without limitation, Purchaser will also comply with U.S. government Export Administration Regulations ("EAR", 15 C.F.R. §§ 730-774, <http://www.bis.doc.gov/>) administered by Department of Commerce, Bureau of Industry and Security and economic sanctions regulations (30 C.F.R. §§ 500 et. seq., <http://www.treas.gov/offices/enforcement/ofac/>) administered by the U.S. Department of Treasury, Office of Foreign Assets Control.

Restricted rights: Use, duplication or disclosure by the United States government is subject to the restrictions as set forth in the Rights in Technical Data and Computer Software Clauses in DFARS 252.227-7013(c) (1) (i) and FAR 52.227-19(c) (2) as applicable.

Other product and company names mentioned herein may be the trademarks of their respective owners.

Any rights not expressly granted herein are reserved.

All illustrations are for illustration only and may not accurately depict the actual phone.

Index

A	
accessories	
settings	62
adding comments to an online photo	29
adding new contacts	20
adding words to dictionary	18
Adobe PDF	51
alarm	
clock	48
signal	61
snooze time	61
alphanumeric keypad	18
application manager	67
applications	52
uninstall	67
assembly	3
audio book	34
accessing	34
auto review	42
auto rotate	42
automatic time update	60
available memory	5
B	
backing up and restoring	48
battery	
charging using a computer	5
charging using the power adapter	5
inserting	3
before	
making video calls	13
you use Google	50
Bluetooth™ wireless technology	55
bookmarks	46
C	
calculator	50
calendar	49
calibration	62
call	
time and cost	16
waiting	15
call list	14
camera	37
camera album	27
cell broadcast settings	64
change	
main menu view	8
changing	
date and time	60
language	60
profiles	59
standby screen	59, 60
themes	59, 60
charging	4, 5
clock	48
comments on an online photo	28
conference calls	15
contact picture	33
contacts	
calling	21
copying between SIM and phone memory	21
edit	20
new	20
sending messages	21
video call	21
converter	50
copying and pasting	
text	20
costs	11
creating new tags	28
cropping a photo	31
D	
date and time	60
default settings	67
deleting photos from a web album	29
deleting tags	28
details of a web album	29
details of an online photo	29
display	61
diverting calls	14
download	
settings	61
downloading music	52
E	
editing contacts	20
editing photos	30
adding a frame	32
adding filter effects	33
adjusting brightness	31
adjusting contrast	31
adjusting sharpness	31
cropping a photo	31
decreasing photo size	31
inserting a talk bubble	32
inserting clip art	32
inserting texts	32
reducing red-eye effect	32
rotating a photo	31
editing tags	28
effects	
black & white	41
negative	41
sepia	41
solarise	41
email settings	63
emergency calls	13
entering text	16, 18
exposure	40
F	
factory settings	67
favourite places	
new	44
send	44
flight mode	59
focus	
face detection	39
infinite	39
macro	39
font	61
G	
geotag	42
Google Maps™	45
Google™	50
GPS	43
GPS data	44
H	
handling two voice calls	15
handwriting recognition	16

settings	62	N	
touch input	62	navigating menus	8
help	2, 5	networks	13
Google Maps	45	night mode	42
history pages	46	notes	50
I		O	
image stabiliser	41	on-screen keyboard	17
inserting texts on a photo	32	on-screen keypad	17, 18
installation		organiser	47
settings	67	P	
installation files		PC Companion	54
sending	67	PC Suite	58
Internet	46	phone	
K		turning on	4
key lock	8	phone	
keyguard	8	language	61
keys	6	phone memory	5
L		phone name	55
language	60	phone overview	6
light	40	photo	27
location information	42	latest photo	27
location services	43	photo information	30
lock		printing a photo	30
screen	8	viewbar	27
logging out of web albums	29	web albums	28
M		zooming a photo	30
main menu view		photo editing	30
change	8	photo tags	27
making and receiving calls	12	picture size	40
master reset	67	pictures	29
media	25	PIN	4
marking items	26	playlists	36
more commands	26	adding the current track	35
music	33	adding tracks	36
navigation	26	removing tracks	36
photo	27	PlayNow™ application	52
play view	26	podcasts	47
touchbar	25	positioning	43
updating media libraries	26	positioning methods	45
viewbar	25	positioning settings	45
media server		posterising a photo	32
DLNA™	57	predictive	18
server settings	57	predictive input	18
using media server	57	profiles	59
memory	5	changing	59
memory card	5	edit	59
menu overview	7	new	59
messaging settings	62	Q	
microphone	42	Quickoffice™	51
more		R	
browser features	46	radio	53
than one call	15	red-eye effect reduction	32
more calling features	14	removing tags	28
multimedia message settings	63	restricted dialling	16
multitap text input	18	RoadSync™	51
multitasking	8	roaming	11
music		S	
changing the volume	35	scenes	
managing tracks	35	beach/snow	38
playback controls	34	document	38
repeating all tracks	34	landscape	38
repeating the current track	34	portrait	38
turning off the repeat	34	sports	38
turning off the shuffle	34	twilight landscape	38
turning on the shuffle	34	twilight portrait	38
viewbar	33	screen	
viewing information	35	lock	8
music controls	34		

screen calibration	62	voicemail	14
screen settings	60	W	
search	51	web albums	28
self-timer	40	adding comments	29
sending		changing album details	29
content to another phone	55	deleting online photos	29
installation files	67	logging out	29
sending messages	21	searching for new services	28
sensor settings	61	sending album links	29
setting a photo as a call image	33	sending photo links	29
settings	59	viewing comments	28
accessories	62	viewing photo details	29
applications	62	viewing photos	28
display	61	web feeds	47
download	61	white balance	
positioning	45	cloudy	40
screen	61	daylight	40
setup wizard	59	fluorescent	40
shoot mode		incandescent	40
panorama	39	Wi-Fi™	56
smile detection	39	Wisepilot™	46
touch capture	39	wizard	
shortcuts	60	setup	59
shutter sound	41	world	
SIM card		clock	49
inserting	3	writing language	20
slideshow	33	Z	
speed dial	14	zoom	38
standby	9		
standby screen	59		
changing	60		
synchronising	58, 59		
T			
tags	27		
creating a tag	28		
deleting a tag	28		
editing a tag	28		
removing a tag from a photo	28		
tagging a photo	28		
text			
entry	16		
text message settings	63		
themes	59		
changing	60		
time			
automatic update	60		
time and date	60, 61		
TrackID™	53		
traditional keypad	18		
transfer method			
Bluetooth™ wireless technology	55		
USB cable	54		
transferring and handling content	54		
turning on/off			
Bluetooth™ function	55		
U			
updating phone software	56		
USB cable	54		
V			
video	36		
calls	13		
playback controls	34, 37		
viewbar	36		
video format	42		
viewfinder	38		
viewing online photos	28		
viewing pictures	30		
voice			
recorder	53		