

Thank you for purchasing a Sony Ericsson G700. For additional phone content, go to www.sonyericsson.com/fun.

Register now to get free online storage and special offers at www.sonyericsson.com/myphone.

For product support, go to www.sonyericsson.com/support.

Accessories – More for your phone

Bluetooth™ Headset HBH-PV703

Go wireless with a powerful headset



GPS Enabler HGE-100

Get more from your phone
- add GPS technology. Know where
you are, where you're going and how
to get there.



Bluetooth™ Car Speakerphone HCB-150

High performance car handsfree with
text to speech for convenient calls on
the road



These accessories can be purchased separately but may not be available in every market. To view the full range, go to www.sonyericsson.com/accessories.

This is the internet version of the User's guide. © Print only for private use.

Contents

Getting started 5

Welcome	5
Instruction symbols	5
Additional help	5
Package	6
Overview	7
Before using your phone	9
First time start-up	11

Getting to know the phone 13

Turning the phone on and off	13
The screen	13
Navigation	14
Finding the applications	14
Using the applications	15
Task manager	15
Connecting accessories	16
Updating software	16
Main menu overview*	17
Status bar	18
Importing contact entries	19
Sound	19
Memory card	19
Notes	20

Torch	21
Text entry	21

Calling 25

Networks	25
Making a call	25
Receiving a call	26
Handling two or more calls	26
Video calls	27
Call log	28
Handsfree	28
More features	28
Using contacts	29
Creating contacts	29
Editing contacts	30
Managing contacts	30

Messaging 32

Before you use Messaging	32
Shortcut to Messaging	32
Messages	32
Folders	32
SMS	33
MMS	33
Email	35

More about Messaging	36	Synchronization	52
Internet	39	Bluetooth connection	53
Internet browser	39	Connections manager	53
RSS feeds	40	Wap push	53
Blog	40	Certificate manager and Java certificates	53
Media	41	More features	55
Transferring media files	41	Managing files and applications	55
Updating media libraries	41	Master reset	56
Photos and pictures	41	Power save	56
Music and audio tracks	43	Screen saver	57
Video	44	Important information	58
Camera	45	FCC Statement	66
Taking pictures and video clips	45	Declaration of Conformity for G700	67
Changing the camera settings	46	Index	68
Viewer	47		
Entertainment	48		
PlayNow™	48		
FM radio	48		
TrackID™	50		
Connectivity	51		
PC Suite	51		
USB connection	51		

Sony Ericsson G700

UMTS 2100 GSM 900/1800/1900

This User guide is published by Sony Ericsson Mobile Communications AB or its local affiliated company, without any warranty. Improvements and changes to this User guide necessitated by typographical errors, inaccuracies of current information, or improvements to programs and/or equipment, may be made by Sony Ericsson Mobile Communications AB or its local affiliated company at any time and without notice. Such changes will, however, be incorporated into new editions of this User guide.

All rights reserved.

©Sony Ericsson Mobile Communications AB, 2008

Publication number: 1210-0959.1

Please note:

Some of the services in this User guide are not supported by all networks. *This also applies to the GSM International Emergency Number 112.*

Please contact your network operator or service provider if you are in doubt whether you can use a particular service.

Please read the *Guidelines for safe and efficient use* and the *Limited warranty* chapters before you use your mobile phone.

Your mobile phone has the capability to download, store and forward additional content, for example, ringtones. The use of such content may be restricted or prohibited by rights of third parties, including but not limited to restriction under applicable copyright laws. You, and not Sony Ericsson, are entirely responsible for additional content that you download to or forward from your mobile phone. Prior to your use of any additional content, please verify that your intended use is properly licensed or is otherwise authorized. Sony Ericsson does not guarantee the accuracy, integrity or quality of any additional content or any other

third party content. Under no circumstances will Sony Ericsson be liable in any way for your improper use of additional content or other third party content.

The Liquid Identity logo, PlayNow, TrackID and MusicDJ are trademarks or registered trademarks of Sony Ericsson Mobile Communications AB. Sony, Memory Stick Micro and M2 are trademarks or registered trademarks of Sony Corporation. Ericsson is a trademark or registered trademark of Telefonaktiebolaget LM Ericsson.

TrackID™ is powered by Gracenote Mobile MusicID™. Gracenote and Gracenote Mobile MusicID are trademarks or registered trademarks of Gracenote, Inc.

Bluetooth is a trademark or a registered trademark of Bluetooth SIG Inc. and any use of such mark by Sony Ericsson is under license.

Real is a trademark or a registered trademark of RealNetworks, Inc. Copyright 1995-2008, RealNetworks, Inc. All rights reserved.

Adobe and Acrobat are trademarks or registered trademarks of Adobe Systems Incorporated in the United States and/or other countries.

Microsoft, Microsoft Excel, Microsoft Word, Microsoft PowerPoint, Microsoft Outlook and Windows are either registered trademarks or trademarks of Microsoft Corporation in the United States and/or other countries.

Java and all Java based trademarks and logos are trademarks or registered trademarks of Sun Microsystems, Inc. in the U.S. and other countries. End-user license agreement for Sun™ Java™ J2ME™.

Restrictions:

- 1 Software is confidential copyrighted information of Sun and title to all copies is retained by Sun and/or its licensors. Customer shall not modify, decompile, disassemble, decrypt, extract, or otherwise reverse engineer Software. Software may

not be leased, assigned, or sublicensed, in whole or in part.

- 2 **Export Regulations:** This product, including any software or technical data contained in or accompanying the product, may be subject to U.S. export control laws, including the U.S. Export Administration Act and its associated regulations and the U.S. sanctions programs administered by the U.S. Treasury Department's Office of Foreign Assets Control, and may be additionally subject to export or import regulations in other countries. The user and any possessor of the product agrees to comply strictly with all such regulations and acknowledges that it is their responsibility to obtain any required licenses to export, re-export, or import this product. Without limitation this product, including any software contained therein, may not be downloaded, or otherwise exported or re-exported (i) into, or to a national or resident of, or an entity in, Cuba, Iraq, Iran, North Korea, Sudan, Syria (as such listing may be revised from time to time) or any country to which the U.S. has embargoed goods; or (ii) to any person or entity on the U.S. Treasury Department's list of Specially Designated Nationals or (iii) any person or entity on any other export prohibition list that may be maintained from time to time by the United States Government, including but not limited to the U.S. Commerce Department's Denied Persons List or Entity List, or the U.S. State Department's Nonproliferation Sanctions List.
- 3 **Restricted Rights:** Use, duplication or disclosure by the United States government is subject to the restrictions as set forth in the Rights in Technical Data and Computer Software Clauses in DFARS 252.227-7013(c) (1) (ii) and FAR 52.227-19(c) (2) as applicable.

This product is protected by certain intellectual property rights of Microsoft. Use or distribution of such technology outside of this product is prohibited without a license from Microsoft.

Content owners use Windows Media digital rights management technology (WMDRM) to protect their intellectual property, including copyrights. This device uses WMDRM software to access WMDRM-protected content. If the WMDRM software fails to protect the content, content owners may ask Microsoft to revoke the software's ability to use WMDRM to play or copy protected content. Revocation does not affect unprotected content. When you download licenses for protected content, you agree that Microsoft may include a revocation list with the licenses. Content owners may require you to upgrade WMDRM to access their content. If you decline an upgrade, you will not be able to access content that requires the upgrade.

This product is licensed under the MPEG-4 visual and AVC patent portfolio licenses for the personal and non-commercial use of a consumer for (i) encoding video in compliance with the MPEG-4 visual standard ("MPEG-4 video") or the AVC standard ("AVC video") and/or (ii) decoding MPEG-4 or AVC video that was encoded by a consumer engaged in a personal and non-commercial activity and/or was obtained from a video provider licensed by MPEG LA to provide MPEG-4 and/or AVC video. No license is granted or shall be implied for any other use. Additional information including that relating to promotional, internal and commercial uses and licensing may be obtained from MPEG LA, L.L.C. See <http://www.mpegla.com>. MPEG Layer-3 audio decoding technology licensed from Fraunhofer IIS and Thomson.

Other product and company names mentioned herein may be the trademarks of their respective owners.

Any rights not expressly granted herein are reserved.

All illustrations are for guidance only and may not accurately depict the actual phone.

Getting started

Welcome

Welcome as a G700 user.

This User guide will help you get started using your new phone. To get most out of your phone, please read this chapter first.

Instruction symbols

The following symbols appear in the User guide:

 Note

 Tip



A service or function is network- or subscription-dependent. Contact your network operator for details.



Additional help

The complete user documentation for your phone consists of:

- **User guide** – an overview of your phone.
- **Help in the phone** – in most applications **Help** is available in the **More** menu.

- **Web guide** – an up-to-date user guide with step-by-step instructions and additional information on features available in your phone. You can access the Web guide at www.sonyericsson.com/support.

To access the Web guide from your phone

- 1 From Standby select **Main menu > Internet**.
- 2 Select **More > View > Bookmarks > Web Guide**.

Care instructions

- Use a moist cloth when you clean the screen.
- Only use the stylus provided, or your fingertips, when selecting items on the screen.

For detailed care instructions, see *Recommendations for care and safe use of our products* on page 60.

Package



1 Phone G700

2 Charger CST-70

3 Stylus

4 USB cable DCU-65

5 Battery BST-33

6 User guide

7 CD with PC suite and Media manager software

! *If your package does not include all the listed items please contact your retailer.*

6 Getting started

This is the Internet version of the User's guide. © Print only for private use.

Overview

- 1 Video telephony camera
- 2 Earspeaker
- 3 Screen
- 4 Menu selection key
- 5 Note key (for Note application)
- 6 Back key
- 7 5-way navigation key
- 8 Silent key
- 9 C key (Clear)
- 10 Camera key
- 11 Messaging key
- 12 Volume down key
- 13 Volume up key
- 14 On/off button

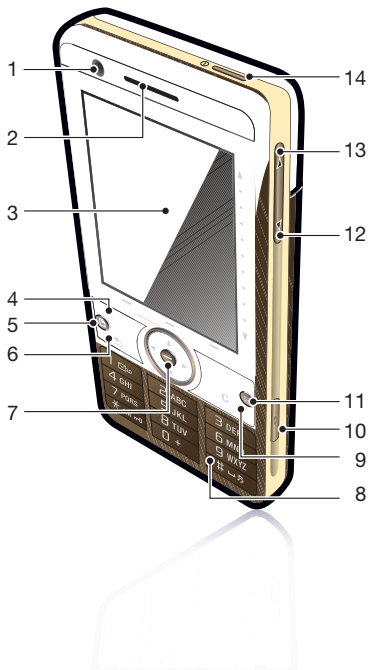

15 Camera light and Torch

16 3.2 megapixel camera

17 Battery cover

18 Loudspeaker

19 Microphone

20 Strap holder

21 Indicator light

22 Connector for charger and accessories

23 Memory card slot

24 Lock key

25 Stylus

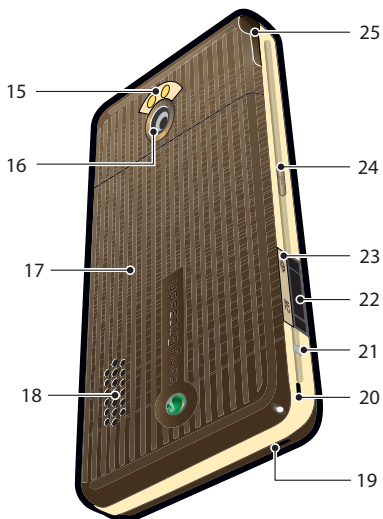

Before using your phone



SIM card

You receive a SIM (Subscriber Identity Module) card when you register with a network operator. The SIM card keeps track of your phone number, the services included in your subscription and contacts. A PIN code is supplied with the SIM card and must be entered, if requested, when you turn your phone on for the first time.

To insert the SIM card

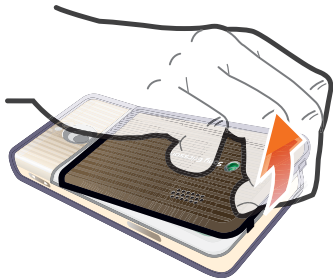

- 1 Open the battery cover by pressing and pulling the lower part of the cover at the bottom of the phone.

- 2 Remove the battery.

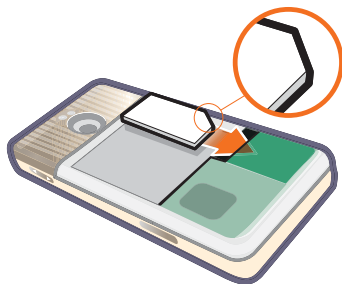

- 3 Insert the SIM card into the SIM card holder. Make sure you insert it as shown in the image.

Battery

To insert the battery

- 1 Detach the charger (if connected).
- 2 Open the battery cover by pressing and pulling the lower part of the cover at the bottom of the phone.

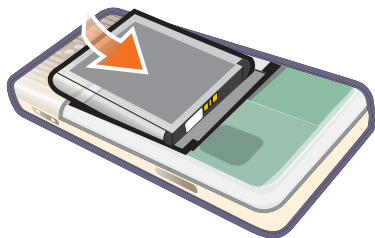

3 Insert the battery.

The battery needs to be charged if the indicator light flashes red, or the low battery message appears on the screen. To fully charge the battery could take up to 2.5 hours.

To charge the battery

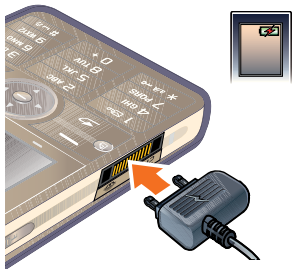

- 1 Connect the charger to the mains.
- 2 Connect the charger to the phone.

To disconnect the charger

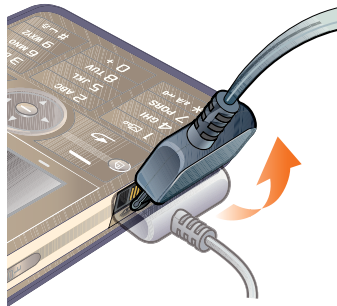

- Remove the charger by tilting the plug upwards.

First time start-up

- ! *Before you can use your phone you need to insert the SIM card, and insert and charge the battery.*

To turn on the phone

- 1 Press and hold down the On/off button.
- 2 Select **Phone on**.
- 3 Select a language.

- 💡 *All languages except UK English will be deleted once you have selected a language. You can download additional languages from www.sonyericsson.com/support.*

- 4 Enter your PIN, if requested.
- 5 Select **Done**.

- 💡 *If you make a mistake when you enter your PIN code, you can delete the number by pressing . If you enter the wrong PIN code three times in a row, the SIM card is blocked. To unblock it, you need to enter the PUK code supplied with your SIM card.*

The start-up screen is referred to as Standby in this User guide.



IMEI number

IMEI (International Mobile Equipment Identifier) is a 15-digit number. Your operator can use

the IMEI number to enable a complete barring of your phone if it is stolen. The number is printed underneath the battery compartment. You can also view the number on the phone display.

To view the IMEI number in your phone

From Standby enter *#06#.

Keylock

Your phone has a dedicated lock key making it easy to lock and unlock the keypad on your phone. The automatic keylock on your phone is turned on as default.

To turn off automatic keylock

- 1 From Standby select **Main menu > Settings > Security > Locks**.
- 2 Unmark the **Automatic keylock** check box.

To lock and unlock the keypad using the lock key

- Press the lock key .



Wizards

There are three wizards available to help you set up your phone. The Setup wizard, the Internet wizard and the Email wizard. The Setup wizard and the Internet

wizard are launched the first time you start the phone. The Email wizard is launched when first launching Email accounts. It is possible to launch all wizards from the Main menu at any time. For more information about the wizards see the Web guide.

Getting to know the phone

Turning the phone on and off

To turn on the phone

- 1 Press and hold down the On/off button.
- 2 Select **Phone On**.

To turn off the phone

- 1 Press and hold down the On/off button.
- 2 Select **Power Off**.

The screen

The screen is touch-sensitive. You can use the stylus or your fingertips to select items.

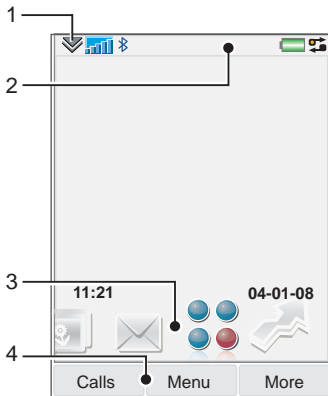





-
- | | |
|---|-----------------------|
| 1 | Status bar menu |
| 2 | Status bar with icons |
| 3 | Panels |
| 4 | Selection keys |
-

Navigation



There are several ways to navigate menus and select items in your phone. You can use the 5-way navigation key, back button, stylus, keyboard navigation keys, touch options or your fingertips.

5-way navigation

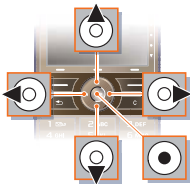
The navigation key consists of a ring and a center key. The ring is used for going up  and down , left  and right . The center key  is used for selection.



Back key

You can press  to return to the previous screen or menu. You can press and hold down  to return to Standby.

Stylus

Use the stylus to select items on the screen and to navigate menus or to pan multimedia pictures.

Finding the applications



Standby

The Standby application is displayed when you turn on your phone.

To change view in Standby



- 1 Select **Main menu > Settings > Display > Standby application.**
- 2 Select:
 - **Business** to show the Today view.
 - **None** to show an enlarged clock. No panels or shortcuts will be shown.
 - **Default** to show the panels.

Panels

Using panels you get quick access to applications and tasks. By default four panels are always shown. These four are **My shortcuts**, **Favourite contacts**, **Calendar** and **New messages**.

There are several other panels you can add and remove. For more information about panels, see the *Web guide at www.sonyericsson.com/support.*

To use panels

- Use  and  to scroll through the panels. Press  to select a panel.

To add additional panels

- 1 From Standby select **More >**
Settings.
- 2 Mark the panels you want and select **Save**.

Main menu

All applications in your phone can be found in Main menu.

To access Main menu

- From Standby select  or **Menu** depending on what Standby application is active.

To change the view of Main menu

- 1 From Standby select **Main menu**.
- 2 Select **More**.
- 3 Select an option.

Using the applications

To start an application

- Select the application.

To close an application

- Press and hold down .

To switch to another application

- Switch to another application using Task manager.

For more information see *Task manager* on page 15.

Task manager

Task manager helps you switch between applications. Leaving an application via Task manager rather than closing it, lets you return to the the application in the state that you left it. This is useful, for example, when cutting and pasting text from one application to another.

To switch to another application

- 1 Select  in the status.
- 2 Scroll to the wanted application and select **Switch**.

To end an application

- 1 Select  in the status.
- 2 Scroll to the wanted application and select **End**.

Connecting accessories

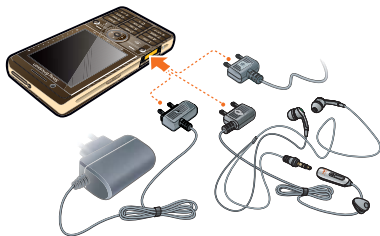

To connect an accessory

- Connect the accessory to the side of your phone.
- ! *Tilt the plug upwards when you disconnect the accessory.*

Updating software

When an improved software version for your phone is available, you can update the phone using the Sony Ericsson update Service on www.sonyericsson.com/support.

Main menu overview*



Organizer

File manager, Tasks, Notes, Quickoffice™, Time & alarms, Torch, Calculator, Converter and more



Internet

Internet browser



Entertainment

Camera, Music applications, TrackID™, RSS feeds, radio, games, and more



Calendar

Touch calendar



Messaging

Messaging application



Media

Media application, where you can handle all your media files, such as music, videos, and more



Calls

Call log



Contacts

Your contacts



Settings

Email wizard and various settings









* Some menus are operator-, network-, and subscription-dependent.













Status bar

Status bar icons

You can select an icon to get more information or to start an application. Below is a short description of the most common icons appearing in the status bar.

Icon	Function
------	----------

	3G available
	Battery strength
	Bluetooth headset connected
	Bluetooth activated
	Current line selection (Alternative Line Service available on the SIM card)
	All calls diverted
	Email message received
	Flight mode
	Internet connection activated (flashes when data is transferred)

	Keylock activated
	Missed incoming call
	Picture message received
	Muted microphone
	Predictive text activated
	Ring volume set to zero
	Signal strength in phone mode
	Silent mode
	Text message received
	Speakerphone activated
	Status bar menu
	Task manager
	Voicemail received

Status bar menu

You can use the status bar menu to quickly access extra settings:

- New call, SMS, MMS and more.
- Connections.
- Volume, time and keylock.

To access the status bar menu

- Select  in the status bar.

Importing contact entries

You can import contact information by:

- Copying contacts stored on your SIM card.
- Transferring contacts from a computer application using the synchronize function.
- Transferring contacts from another phone using Bluetooth™ wireless technology.

Sound

To set the ear speaker volume during a phone call



- Press the volume up and volume down keys.

To set the volume for multimedia, alarm, ringtones and message alerts

- 1 Select  > **Volume**.
- 2 Select the corresponding slider.
- 3 Adjust the volume using the stylus.

To set the phone to silent

- 1 Select  > **Volume**.
- 2 Mark the **Silent mode** check box.

 *From Standby you can press and hold down  to switch silent mode on or off.*

Transfer sound

During an ongoing call or when listening to music, you can transfer the sound to a connected accessory such as a Bluetooth headset.

To transfer sound

- 1 Select  > **Volume**.
- 2 Select **More > Transfer sound**.

Memory card

The phone has a slot for Memory Stick Micro™ (M2™) memory cards next to the connector. The phone supports up to 8GB memory cards. This memory behaves like a normal disk drive. You can access it as a USB mass storage device from a PC, to transfer files quickly.

To insert the memory card

- Insert the memory card into the slot.

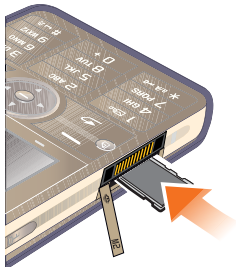

To remove the memory card

- Press the edge of the memory card and then release it.

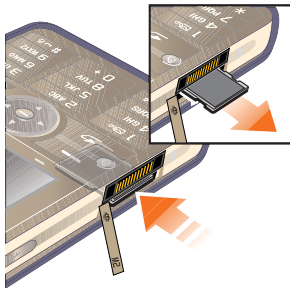

- ! Do not remove the memory card during file transfer.

Notes

You can take notes by entering text or draw sketches, and set reminders for important events.

To create a new note

- 1 Press  and select **New**.
- 2 Use the toolbar to create your note.
- 3 Select **File** to classify your note.

Notes toolbar icons



Scribble mode selected. Select to switch to text mode



Text mode selected. Select to switch to scribble mode



Use the stylus as an eraser for sketches





Select a background colour



Set a reminder

To edit a note

- 1 Press  and select a note.
- 2 Edit the text by switching to text mode.
- 3 Edit the sketch by switching to scribble mode. Select  to use the stylus as an eraser.

Managing your notes

You can classify your notes, show them in a grid or a list, or synchronize them with a remote server.

To change notes view

- 1 Press  and select **More > Settings**.
- 2 Select an option.

To view different notes folders

- 1 Press  and select **More > View folder**.
- 2 Select an option.

To search for notes

- 1 Press  and select **More > Find**.
- 2 Enter the search phrase and select **Find**.

To synchronize your notes

- Select **More > Notes manager > Synchronize**.

! *Only the text part of your notes will be synchronized.*

! *You need a remote synchronization account first. For more information, see the Web guide, Synchronizing data remotely.*

Torch



To start the Torch application

- From Standby select **Main menu > Organizer > Torch > On**.

! *The Torch will be lit until you manually stop from within the application or from Task manager.*

Text entry

Text can be entered in four different ways:

- Keypad prediction – keypad based prediction input.  is displayed in the status bar.
- Handwriting recognition – use the stylus to write characters directly on the screen.  is displayed in the status bar.
- On-screen keyboard – launch by selecting  from the status bar.
- Multitap – standard Multitap keypad input. Multitap is not possible when keypad prediction is active.

! *Choosing a new language in the phone will also automatically change the behaviour of the keyboard to that language.*

Editing text

The text editing options are accessed by selecting **More** when you are in text entry mode.

- ! *Text must be highlighted to get access to copy or cut functions.*

To highlight the text with the stylus

- Hold the stylus at the end of the text for a short while then drag the stylus across the text.

Keypad prediction

Keypad prediction allows words to be entered by a single press of a key to input any of the letters associated with that key. A word is suggested where you are writing, additional suggestions are presented in a list.

- ! *Word suggestion must be activated to get word suggestions in the list.*



To activate keypad prediction

- Press and hold down .

To activate word suggestion

- 1 From text entry mode select **More** > **Text options**.
- 2 Select **Word suggestions**.

To enter the word “Large” using keypad prediction

- 1 Press .
- 2 Scroll to the L character in the list.
- 3 Press .
- 4 Scroll to the predicted word Large in the list.
- 5 Select the word by pressing  on the 5-way navigation key.

Handwriting recognition

Handwriting recognition translates stylus gestures written directly on the screen into letters, numbers or other characters, and displays these characters as text.

Handwriting recognition is only active in places where text can be entered.

To activate handwriting recognition

- Press and hold down .

To write letters

a a A	n n N N	.	\
b b B B B	o o O	,	└
c C	p p P	?	? ₂
d d D D	q q Q	!	! ₂
e e E	r r R R	&	&&
f f F f ¹	s S	@	@
g g G G t	t t ¹ t ² t ³	'	7
h h H H	u u U	"	77
i i I i	v v V	→	└
j j J j ¹ j ² j ³	w W	└	└
k k K k k	x x X ²	←	└
l l L L	y y Y	↶	↷
m m M	z z Z z		

- Write lower case letters below the arrow and upper case letters in line with the arrow.

 Start each stroke at the dotted end.

To write accented letters

- 1 Write the basic letter.

à	\	â	^	ä	.. or //		
á	/	ã	N	â	o	š	v

- 2 Write the accent above the arrow to form the accented letter.

To write numbers

0	o o O	8	8 8	=	==
1	1 1	9	9 9	.	\
2	2 2	+	+ ²	,	└
3	3	*	* ²	~	N
4	'4 ² 4 4	/	/	←	└
5	5 5	\	\	→	└
6	6	((
7	7))		

- Write numbers above the arrow.

Text options

Text options are accessed by selecting **More > Text options** when in text entry mode.

To add a symbol

- 1 Select **Add symbol** to launch the symbols and punctuation marks table.

- 2 Select the symbol you want to add.

To add words to My words dictionary

- 1 Select **My words**.
- 2 Select **Add**.
- 3 Write the new word and select **Done**.
- 4 Select **Save**.

To change 1st and 2nd dictionary languages for text prediction

- 1 Select **More > Text options** and mark the Predictive text check box.
- 2 Select **1st language** or **2nd language**.
- 3 Select a language from the list.
- 4 Select **Save**.

To activate Auto capitalization

- Mark the **Auto capitalization** check box.

To access the on-board help

- 1 From Standby select **Main menu > More > Help**.
- 2 Select **Handwriting recognition**.
The help text for handwriting recognition is displayed.

On-screen keyboard

The on-screen keyboard enables you to select characters and symbols with the stylus. The on-screen keyboard can be set to different languages.

To use the on-screen keyboard

- Select the on-screen keyboard symbol  located in the status bar.

To change language of the on-screen keyboard

- Select **▽ > Setup** and select a language.

Calling

Networks

Network coverage

To make or receive a phone call your phone must be within range of a network.

Network settings

You can set how your phone should choose an available network when you are outside your operator's coverage area. From Standby you find the settings in [Main menu > Settings > Connectivity > Mobile networks](#).

Making a call

To make a call from Standby

- Enter the phone number (including the area number) on the keypad and select **Call**.

To make an international call

- 1 From Standby press and hold down  to get the international call prefix.
- 2 Enter the country/region code, area code (without the first zero) and phone number.

- 3 Select **Call**.

To delete characters when dialling

- When entering a number you can delete characters by pressing .

Hide or show your phone number

When calling, you can choose in the **More** menu whether to show or hide your phone number to the called party.

Speed dial

You can save up to nine of your contacts as Speed contacts. This means that you can call them using abbreviated numbers (numbers 1 – 9).

To set a speed contact (number)

- 1 From Standby select [Main menu > Organizer > Speed contacts](#).
- 2 Scroll to an empty position and select **Add**.
- 3 Select a contact in the list and select **Save**.

To make a call to a speed contact

- 1 From Standby press one of the keys 1 to 9 that corresponds to the stored speed contact.

- 2 Select **Call**.

To make an emergency call

- 1 From Standby, enter the emergency number on the keypad.
- 2 Select **Call**.

Local SOS numbers

When dialling, you can find local SOS numbers in the **More** menu.

- ! *Usually no SIM card or PIN code is required for emergency calls, but this can be operator-dependant. Contact your operator for more information.*

Receiving a call

To answer a call

- Select **Yes**.

To reject a call with busy tone

- Select **No**.

Rejecting a call with an SMS text message

This feature means that you can reject a call by sending a pre-defined SMS text message to the caller. Before you use it, enter the settings from Standby in **Main menu > Settings > Calls > Reject with SMS**. (You will be charged by

your operator for the SMS message.)

To enable the speakerphone

- During a call, select **More > Speakerphone on**.

To mute the microphone (shortcut)

- During a call, press and hold down .

To un-mute the microphone (shortcut)

- When the microphone is muted, press .

To mute the ringtone

- Select **Mute** or press .

Handling two or more calls

You can handle multiple calls at the same time:

- Put an ongoing call on hold and start a new one, or answer an incoming call.
- Start a conference call during an ongoing call (operator-dependent).

- Extract one party in a conference call for a private talk and put the conference call on hold.
- Retrieve a held call, or end it.

Conference call

You can start a conference call if you have one active call and one on hold. The maximum number of conference parties is five.

To make a conference call

- 1 Make a call and select **Hold**.
- 2 Repeat the above step for each party.
- 3 Select **More > Start conference call**.



Video calls

When you make a video call you can see the person you are talking to on the screen.

- ! *This feature is network- or operator-dependent. The service may not always be available in all countries or when you are roaming. Please contact your operator for more information about your subscription and video calls.*

To make a video call from Standby

- 1 Enter the number using the keypad.
- 2 Select **More > Video call**.

To accept an incoming call

- When you receive a call, select **Yes**.

Video call demo mode

If you select the **Video phone** application in **Main menu > Entertainment** you can try most of the functions without making a call. For example, you can prepare a camera view before calling.

Zoom

You can zoom the outgoing video feed captured with the rear camera. There are four zoom levels.

To zoom the outgoing video feed

- Use **▼** to zoom out and **▲** to zoom in.

Paused picture

If the video feed is stopped, a paused picture is sent to the other person. If you have not set any

paused picture, a default picture is shown.

To set a paused picture

- 1 From Standby select **Main menu > Entertainment > Video phone**.
- 2 Select **More > Advanced > Paused picture**.
- 3 Select a picture and select **Save**.

To pause and resume the outgoing video feed

- During an ongoing video call, select **Camera** whenever you want to pause or resume the outgoing video feed.

To switch between front and rear camera

- During an ongoing video call, select either **Use front camera** or **Use rear camera** in the **More** menu.

Options when making or receiving a video call

Some options in the **More** menu are:

- **Hide small picture/Show small picture** – choose whether to remove the small picture from the display.

- **Turn on night mode** – set a brighter image when the lighting is poor.
- **Share data** – send a vCard, SMS or MMS message.
- **Advanced** – enter settings preferably before you use the application.

Call log

In the call log you can find call information, such as the type of call, time, date, phone number and call length. From Standby select **Calls** to open it. You can also make a call or a call note directly from this application.

Handsfree

If you connect a handsfree or a Bluetooth™ headset to your phone, you will need to set how to answer an incoming call. From Standby select **Main menu > Settings > Calls > Handsfree**.



More features

Some of the features that your phone supports can be found in **Main menu > Settings > Calls**:

- **Accept calls** – caller filter.

- Add to contacts – add contact data from the last call.
- ALS – line settings, if your SIM card supports two lines.
- Call meter – service to keep track of your call costs.
- Calling cards – call via a calling card server.
- Call waiting – option to get alerted if there is another call on the line.
- Divert calls – divert calls to other numbers.
- Fixed numbers – only special numbers can be called.
- Flag call – reject a call and set a reminder to follow it up later.
- My number – option to save your own number.
- Restrict calls – options to set roaming and international call restrictions.
- Textphone accessory – use of a teletype writer.
- Voicemail – “answering machine”.
- Voice control – you can call and answer with voice commands.

! *Many of these features are operator-dependent and may not be available. For more information about these, and other features, see Calling and Settings in the Web guide.*

Using contacts

To make a call using Contacts

- 1 From Standby select **Main menu > Contacts** and scroll to the desired contact.
- 2 Select **View** to open the entry.
- 3 Scroll to the desired phone number and select **Call**.

💡 *You can also press **Ⓜ** on the 5-way navigation key to open Contacts.*

To find service numbers on the SIM card

- 1 From Standby select **Main menu > Contacts**.
- 2 Select **More > View folder > SIM**.
- 3 Select **More > Service numbers**.

Creating contacts

To create a new contact

- 1 From Standby select **Main menu > Contacts**.
- 2 Select **More > New contact**.

- 3 You can enter contact data on four tabs.
- 4 Select **Save**.

 If you save your contacts' phone numbers in the international number format, starting with +, you can call directly from Contacts when you are abroad.

Editing contacts

To add a field to a contact

- 1 From Standby select **Main menu > Contacts**.
- 2 Scroll to a contact and select **More > Edit contact**.
- 3 Select **More > Add field** and mark a field.
- 4 Select **Add**.

To edit a contact on the SIM card

- 1 From Standby select **Main menu > Contacts**.
- 2 Select **More > View folder > SIM**.
- 3 Scroll to a contact and select **More > Edit contact**.

To add a stored picture to a contact

- 1 From Standby select **Main menu > Contacts** and scroll to a contact.
- 2 Select **More > Edit contact**.

- 3 Scroll to the **Picture** field and select **Edit**.
- 4 Choose **Select** and scroll to a picture you want to add.
- 5 Choose **Select > Save**.

To add a personal ringtone to a contact

- 1 From Standby select **Main menu > Contacts** and scroll to the desired contact.
- 2 Select **More > Edit contact**.
- 3 Select the audio tab .
- 4 Scroll to the **Ringtone:** drop-down menu and select **Open > Find sound**.
- 5 Scroll to the sound you want to add.
- 6 Choose **Select**.
- 7 Select **More > Save**.

Managing contacts

To copy a contact to another folder

- 1 From Standby select **Main menu > Contacts** and scroll to a contact.
- 2 Select **More > Add to >** desired folder.

To delete a contact

- 1 From Standby select **Main menu > Contacts** and scroll to a contact.

- 2 Select **More > Delete**.

To copy contacts to the SIM card

- 1 From Standby select **Main menu > Contacts**.
- 2 Mark the desired entries in Contacts.
- 3 Select **More > Add to > SIM**.

To copy contacts from the SIM card

- 1 From Standby select **Main menu > Contacts**.
- 2 Select **More > View folder > SIM** to open the SIM card.
- 3 Mark the desired entries.
- 4 Select **More > Copy to Contacts**.

Messaging

Before you use Messaging

Before you can send or receive any messages (except for SMS text messages) you need to set up the necessary accounts. You can use the Internet and Email wizards provided in the phone to download settings or do this manually. See *Setting up Internet, email and MMS* in the Web guide.

Shortcut to Messaging

To start Messaging

- Press  on the keypad.

Messages

You can create, send, and receive different types of messages:

 SMS (Short Message Service) – text messages

 MMS (Multimedia Message Service) – picture messages that can include text, pictures and sound

 Email messages

 Beamed messages via Bluetooth

You can also receive:

 Auto setup files for configuring Internet, email and MMS

 Area information messages such as local road reports

Folders

The different types of messages are handled by different accounts. The default account, Messages, handles all messages except email messages. Email messages are handled by email accounts you create yourself. All accounts consist of a number of folders. You can switch between folders by selecting the arrow beside the folder name:

- Inbox in Messages – contains all received messages except email messages. In **Main menu > Settings > Sounds & alerts > Message alerts** you can set how you will be notified when a message is received.
- Inbox in an email account – contains the received email messages for that particular account.
- Outbox – contains messages ready to be sent.
- Drafts – contains messages that are not ready to be sent. When you are creating a message, and exit the message before sending it, you will be asked if you want to save it. If you select **Yes**, the message will automatically be stored in this folder.
- Sent – contains sent messages.
- SIM – a folder located on your SIM card.

SMS

To create and send an SMS message

- 1 Press  on the keypad.
- 2 Select **Create new message > SMS**.

- 3 Enter the phone number of the recipient using the keys, or tap **To:** > **Select contact** and browse to your contact.
- 4 Write the message and select **Send**.

MMS

MMS messages can include pictures, video clips, animations and sound, organized like a slide presentation with time-based control of playback.

Before you use MMS

Before you can send and receive multimedia messages you need to download MMS settings. You can use the Internet wizard available in the phone in **Main menu > Settings > Connectivity > Internet wizard** or, if your operator is not supported by this wizard, do this manually. See *Setting up Internet, email and MMS* in the Web guide.

An overview of MMS

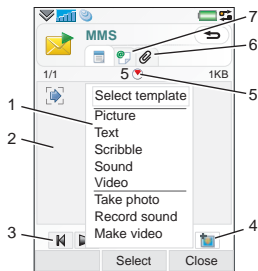

- 1 Menu options. You can select a template or what you want to add to the message, for example a picture or sound. (If the menu is not open, select **Add**.)
- 2 Entry field (on the detail tab) where you can create your message
- 3 Playback keys
- 4 New page icon

5 Time view icon. Opens a view where you can adjust when and for how long your added items will be shown

6 Attachments tab

7 Address tab for the recipient and other details

To create and send an MMS

- 1 Press **⏏** on the keypad.
- 2 Select **Create new message > MMS**.
- 3 Add picture, text and sound as desired.
- 4 Select **📧** and fill in the recipient's details. To send a message to several recipients, type a comma between each address.
- 5 Select **Done**.
- 6 Select **More > Send**.

To read an MMS

- Select the new message.
- ! *The first time you open the message it plays automatically. After that, you have to use the playback keys to play it.*

Email

Before you use email

To use email you require an Internet account and will need to download the necessary email settings. You can use the Email wizard available in the phone under **Main menu > Settings > Messaging > Email accounts** or, if your operator is not supported by this wizard, do this manually. See the Help in the phone or *Setting up Internet, email and MMS* in the Web guide.

Sending email messages

You can create email messages from each email account.

To create and send an email message

- 1 Press **Ⓜ** on the keypad.
- 2 Select **New**.
- 3 Tap **To: > Select contact** and browse to your contact or tap to the side of **To:** and write the email address of the recipient. To send a message to several recipients, type a comma between each address.
- 4 Select **Subject:** and enter details.

- 5 Write your message and select **Done**.
- 6 Select **Send**. You will have the option to send the message immediately, or to save it to Outbox.

Receiving email

Email messages are downloaded from the email server on the Internet or at your office. You can download your email manually or set when your phone should check for new email.

To download email messages manually

- 1 Press **Ⓜ** on the keypad.
- 2 Select your email account.
- 3 Select **More > Get & send**.

To download messages automatically

- 1 From Standby select **Main menu > Settings > Messaging > Email accounts**.
- 2 Select your email account.
- 3 Select **More > Scheduled download**.
- 4 Mark the **Schedule download** check box and enter the times when you would like to download email messages.

5 Select **Save**.

- ! For IMAP accounts you can also select **Push email** and have new email messages pushed to your phone.

To forward an email message

- 1 From your email account in Messaging scroll to the message you wish to forward.
- 2 Select **More > Forward**.

- ! Large attachments increase the size of an email and the connection time needed to send it. It is possible to choose whether to forward the attachment.

Viewing messages

You can choose not to receive large messages and only to receive a header.

To download headers

- 1 From Standby select **Main menu > Settings > Messaging > Email accounts**.
- 2 Select your email account.
- 3 Select the **Inbox** tab.
- 4 From **Download restrictions**, select **Just headers**.
- 5 Select **Save**.

To view messages in full screen

- 1 Press **⌘** on the keypad.

2 Select your email account.

- 3 Select **More > Settings > Always fullscreen**.

Viewing attachments

To view an attachment you need a viewer for that type of file. Your phone comes with pre-installed viewers for Microsoft® Word, Microsoft® Excel®, Microsoft® PowerPoint®, and Adobe™ Acrobat™ files.

More about Messaging

Deleting email

You can delete a message both locally and on your email server. When you delete it locally, the message body and attachments are deleted but the heading remains. You can download the message again later with the **Get & send** option. When you delete the message on your server, it is deleted both in your phone and on your server.

To find a message

- 1 Press **⌘** on the keypad.

- 2 Select **More > Find message** to search through the subject lines, sender details and the text of the message.

! *In an open message, **Find** searches through the message.*

Saving contact details

When you receive a message, you can save the contact details of the person who sent the message.

To save a sender's contact details

- 1 Select the sender's phone number, name or email address in the details tab or **From:** in the address tab.
- 2 Select **Add to Contacts**.

Disconnecting from the Internet

If your phone is already connected to the Internet when you send an email message or an MMS message it remains connected after sending.

To disconnect from the Internet

- 1 Select the connection icon, for example , in the status bar.
- 2 In Connections manager, mark the check box for your connection.

- 3 Select **Close**.

Invitations

If you receive an invitation to an appointment via an email message, and you accept, your calendar will be updated automatically. You can also reply to and forward an invitation.

Push email

With push email, email messages received in your ordinary mailbox will automatically be sent to your phone. You can send messages from your phone, and also use Calendar and Contacts as if you were using the ordinary email application in your computer.

Depending on your operator and market, you can have a different push email client installed on your phone.

IMAP Push email is also available on your phone.



To set up IMAP Push email

- 1 From Standby select **Main menu > Settings > Messaging > Email accounts**.
- 2 Select your email account.
- 3 Select the **Basic** tab.

- 4 Select **IMAP** in **Connection type**:
- 5 Mark the **Push email** check box.
- 6 In **Email accounts** select **More >**
Always On push email.
- 7 Mark the **Always On** check box.
- 8 Select **Save**.
- 9 For more information on push email contact your operator, your service provider or your IT administrator.

For more information about push email see *More about Messaging* in the Web guide.

Internet

Internet browser





To use the browser you need an Internet connection. See *Setting up Internet, email and MMS* in the Web guide.







To start the browser

- From Standby select **Main menu > Internet**.

Navigation

All navigation commands and settings are available from the **More** menu. The most common operations are also available as keyboard shortcuts.

Key	Function
	Enter address
	Open the bookmarks list
	Close the current page
	Go to the homepage
	Switch between loading and not loading pictures

	Switch between normal and Fullscreen display
	Switch to the next page
	Open the Configuration menu
	Add a bookmark for the current page
	Find (on the Internet or on the current page)
	Go to the top or bottom of the page
	Stop or Reload the current page

Settings

To switch to landscape view

- With the browser open select **More > Settings** and mark the **Landscape** check box.

To exit landscape view

- Select  **> Settings** and unmark the **Landscape** check box.

RSS feeds

RSS feeds allow you to see when new content has been added to a Web site. You can, for example, get the latest headlines without having to visit the Web site.

You can add feeds directly in the RSS feeds application. An easier way is to add feeds from within the Internet browser.

Before you use RSS feeds

To use RSS feeds you need an Internet connection. See *Setting up Internet, email and MMS* in the Web guide.

To subscribe to an RSS feed

- 1 From Standby select **Main menu > Entertainment > RSS feeds**.
- 2 Select **More > Add feed** and enter the address to the feed.
- 3 Select a folder to add the feed to.

To subscribe to an RSS feed from the Internet browser

- 1 From Standby select **Main menu > Internet**.
- 2 Navigate to a page that offers RSS feeds.
- 3 Select  and choose between the available feeds.

- 4 Select a feed and which folder to add it to.

To view an RSS feed

- 1 From Standby select **Main menu > Entertainment > RSS feeds**.
- 2 Select a feed and select **Open**.

Blog

Use the Blog function to publish, for example, your photos on Internet.

To send a photo to a blog

- 1 Navigate to your photo and select it.
- 2 Select **More > Send as > Blog**.
- 3 Enter a title and text.
- 4 Select **Publish**.

The first time you will get a bookmark added in your phone and information about how to edit the blog on the internet.

Media

With the Media application you can handle all your media files, such as photos and pictures, music, other audio tracks and video clips. From Standby select **Main menu > Media** to select either of these main functions:

- **Photo** – view, edit, send or blog your photos and pictures.
- **Music** – categorize and play your music files or other audio tracks.
- **Video** – play and handle your video clips.
- **Settings** – change application orientation, update your libraries or use the encoding function.

Transferring media files

Media Manager computer software and USB drivers are included on a CD that comes with the phone. Use Media Manager to transfer media files from CDs or your computer to your memory card in the phone. See the Web guide for more information.

Updating media libraries

The first time you use the Media application, or when you have transferred media files to your phone with the USB cable, your media libraries automatically update.

To manually update media files

From Standby select **Main menu > Media > Settings > Update library**.

Photos and pictures

Viewing and using pictures

In Photo you can view, send and use all pictures saved in your phone memory or on a memory card. From Standby select **Main menu > Media > Photo** to select either of these viewing options:

- **Latest photo** - the latest captured photo/video saved in your phone or on a memory card.
- **Camera album** - photos and videos captured with a camera, presented in chronological order, by month.
- **Photo tags** - view your photos that you have tagged.

- **Pictures** - pictures that are not captured with a camera, such as preloaded and downloaded pictures.

To view pictures in a slide show

- 1 From Standby select **Main menu > Media > Photo** and select one of the viewing options.
- 2 Select **View > Start** to run an automatic slide show.
- 3 Select one of the pre-defined sounds or choose your own by selecting **Edit**.

To send a picture

- 1 From Standby select **Main menu > Media > Photo** and select one of the four viewing options.
- 2 Select a picture.
- 3 Select **More > Send as** and choose to send the file by Bluetooth™, in an MMS message or to a blog.

Remote screen

You can use a compatible Bluetooth™ accessory to view pictures on a remote screen, such as a TV. For a list of compatible accessories go to www.sonyericsson.com/support.

To send pictures to a remote screen

- 1 From Standby select **Main menu > Media > Photo** and select one of the viewing options.
- 2 Select **More** and mark **Remote screen**.
- 3 Select the desired remote screen.
- 4 Select **Yes** to enable the Bluetooth™.
- 5 Open a picture. It will automatically be sent to the remote screen.

! *Make sure you are in full screen play view and tap the screen if the slideshow options are not showing.*

Editing pictures

Using the editor, you can photo fix, pan, zoom and rotate your image. There are also filters for effects and picture correction.

To edit a picture

- 1 From Standby select **Main menu > Media > Photo**.
- 2 Select a picture.
 - Select **More > Edit**.

For more information about the features and how to use them, see the Web guide in your phone or on the Sony Ericsson Webpage.

Music and audio tracks

The music player supports formats such as MP3, WMA, WAV, AAC, AAC+ and eAAC+. For a list of all supported media formats, see the Web guide.

To play music or other audio tracks

- 1 From Standby select **Main menu > Media > Music**.
- 2 Browse for music/tracks by **Albums, Artists, Tracks, Compilations, Auto playlists, Playlists, Audiobooks, Podcasts and My recordings**.
- 3 Scroll to the desired track and select **Play**.

Playback controls

 Play

 Stop



 Skip to previous track

 Skip to next track

To adjust the volume

- Press the Volume keys.

To minimize the music player

- When the music player is open press and hold down . The music will continue to play. To return to the music player, press  in the Status bar.

Playlists

A playlist describes which tracks to play, and in which order. The playlist only contains links to the tracks, so when you remove tracks from the playlist, the actual sound files are not deleted.

To create a playlist

- With **Media** open, select **Music > Playlists > New playlist**.

To add songs to a playlist

- 1 With **Music** open, mark one or more tracks.
- 2 Select **More > Add to playlist**.

Auto playlists

The music player creates automatic playlists based on, for example, how often you listen to the tracks.

Bookmarks

If you stop the playback of an audiobook or a podcast channel, a bookmark is automatically set on

this position. For more information, see *Media* in the Web guide.

Video

With **Video**, you can watch clips stored on your phone. Video can play MPEG-4, H.263, H.264, WMV9 and Real Video formats.

To play a video clip

- 1 From Standby select **Main menu > Media > Video**.
- 2 Navigate to the clip you want to watch and select **Play**.

Playback controls

During playback, you can use the playback controls. See *Playback controls* on page 43.

To move within a video clip

- Tap on the progress bar.

To change screen orientation

- During playback, tap the screen in the video playback area to switch between landscape and portrait view.

Camera

The 3.2-megapixel camera can take both still pictures and video clips. You can save them in the phone or send them as MMS. Exposure control is automatic and in poor light conditions you can use the camera light.

Taking pictures and video clips

To take a picture or a video clip

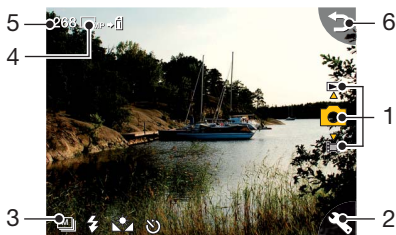

- 1 Press the camera key to activate the camera.
- 2 Change the settings if necessary.
- 3 Press the camera key to capture the picture.



-
- 1 Use the navigation keys up and down to choose between picture mode, video mode or view mode. Selected mode is yellow
-
- 2 Press once to change the most often used settings. Press twice to access the photo setup settings.
-
- 3 Overview of the most often used settings
-
- 4 Overview of the photo setup settings
-
- 5 The remaining number of pictures for the current settings
-
- 6 Go back to previous view
-

Use the volume keys to zoom in and out. Use the left and right navigation keys to change the brightness.

Changing the camera settings

 Press   to see how you can use the keypad keys as shortcuts for some of the most frequently used settings. Press the key again to remove the description.

Most of the settings you make will remain until you change them, even if you have switched the camera or your phone off.

To change the most used settings

- 1 Press  once to open the list of settings.
- 2 Select the required setting to see the options for this setting.
- 3 Select an option to change the setting.

The available settings will vary depending on whether picture or video mode is selected and what the setting is set to. The settings are:

-  **Shoot mode** – select what sort of pictures or video clips to take.

 **Flash or Light** – select **On** to turn on the photo light.





 **Self timer** – select **On** to take pictures with a time delay.

 **Scenes** – select **Night mode** to make the camera more light sensitive in poor light conditions.



White balance – select an option that matches the lighting conditions.

To access the photo setup menu

- 1 Press  and then  (at the same position) to access the photo setup menu.
- 2 Select the setting to change.

The photo setup menu contains:

- **Picture size** – select what picture size to use.
- **Self timer** – select **On** to take pictures and clips with a time delay.
- **Effects** – set and view different effects before you take a picture
- **Picture quality** – select a quality level.

- **Microphone** – select **Off** to turn off sound recording.
- **Auto review** – show the picture or video clip automatically after it has been taken.
- **Save to** – select if pictures and clips will be saved to the memory card or the phone memory. If you select **Memory Stick preferred** they will be saved on the phone memory when there is no room left on the memory card.
- **Shutter sound** – select (or mute) a shutter sound.
- **Reset** – restore the settings to their default values.

To manage pictures and video clips

- 1 When you view pictures and video clips, select **More**.
- 2 Select an option.

Viewer

You can view the pictures or video clips you have captured and also manage them in several ways.

To open a menu with viewer options, select **More**.

Using **Tag this photo** you can categorize the pictures or video

clips and sort them into different photo tags.

See *Photos and pictures* on page 41 for more information about the viewer.

To send a picture or video clip using MMS

- 1 In the viewer select **More > Send as** to launch Messaging and insert the picture or clip into an MMS.
- 2 Follow the instructions in the phone. See also *MMS* on page 33.

Entertainment



PlayNow™

PlayNow™ is an entertainment download service. You can preview content before purchase.



This service is not available in all countries.

Before you use PlayNow™

To use PlayNow™ you need an Internet connection. See *Setting up Internet, email and MMS* in the Web guide.

Previewing content

You can download a preview sample for most content available at PlayNow™ before deciding to purchase.

To preview PlayNow™ content

- 1 From Standby select **Main menu > Entertainment > PlayNow™**.
- 2 Select **Preview** or **Play** for the content you wish to preview.

Purchasing content

When purchasing content from PlayNow™, the cost of this service will be displayed in your phone. The cost will be debited to

your prepay card or your phone bill.

To purchase PlayNow™ content

- Select **Buy** next to the content you want to purchase and follow the on-screen instructions.

FM radio

To listen to the radio you need to insert the handsfree, since the radio uses the handsfree cable as antenna. However, you can still listen to the sound through the speaker or through a Bluetooth™ connected headset.

To listen to the radio

- 1 Connect the handsfree to the phone.
- 2 From Standby select **Main menu > Entertainment > FM radio**.

To automatically find and store radio channels

- From Standby select **Main menu > Entertainment > FM radio > More > Auto store**.

To transfer the sound

- When the FM radio is open select  and select, for example, the built-in speaker or a Bluetooth™ headset.

To minimize the radio

- When FM radio is open press the back key. The radio will continue playing in the background.

To return to the radio

- Select  in the status bar.

To turn the radio off

- When the FM radio is open select **Off**.



Tuning and presets

To search for radio channels

- When FM radio is open select  or .

To tune manually

- 1 When FM radio is open select **More > Set frequency**.
- 2 Enter the frequency using the keys.





 You can also press  or  to change the frequency in 0.1 MHz steps.

To store a preset



- 1 When FM radio is open tune to the desired channel and select **More > Save**.
- 2 Select a preset number between 1 and 20 and select **Insert**.

To recall a preset

- 1 When FM radio is open select **Presets**.
- 2 Scroll to the desired channel and press .

 You can use presets 1 to 10 by pressing  to  and . Press and hold down to store, press briefly to recall.

RDS (Radio Data System)

The RDS functionality lets you set the radio to automatically switch to a channel when it is broadcasting **Traffic announcements**, , or **News announcements**, . The radio can also re-tune to the **Alternative frequency**  that gives the best reception for the station you have selected.

 *Not all radio channels transmit RDS information.*

To access RDS settings

- When FM radio is open select **More > Settings > RDS options**.



TrackID™

You can use TrackID™ to find out the name of a song. You record a few seconds of music using the microphone or from the built-in FM radio. The sample is then sent to the TrackID™ database. If a match is found you will see the name of the artist, the album and the title of the song. The TrackID™ service is free, but your service provider may charge for the data traffic.

- ! *This service is not available in all countries.*

Before you use TrackID™

To use TrackID™ you need an Internet connection. See *Setting up Internet, email and MMS* in the Web guide.

To identify a song using the microphone

- 1 From Standby select **Main menu > Entertainment > TrackID™**.
- 2 Hold the phone close to the speaker and select **Start**.

To identify a song played on the FM radio

- When the radio is open, tap .

Connectivity

To exchange information between your phone and another device you can use, for example, a USB or a Bluetooth™ connection.

PC Suite

When connecting your phone to a computer, certain tasks require that you have PC Suite for Sony Ericsson installed on your computer. Install it from the CD delivered with your phone or go to www.sonyericsson.com/support for the latest version.

You can use PC Suite for many things, including synchronizing phone data with Microsoft® Outlook® in your computer or making backups of phone data. See *PC Suite* in the Web guide for more information.

PC Suite requires a USB cable connection, but for certain applications you can alternatively use a Bluetooth connection.

USB connection

With a USB connection you can, for example, transfer files between

your phone and a computer, synchronize and make backups of phone data.

When you connect your phone and computer using the USB cable two options appear, **File transfer mode** and **Phone mode**.

- ! *To transfer files in file transfer mode you do not need PC Suite installed on your computer. For phone mode, PC Suite is required.*

File transfer mode

In file transfer mode you can transfer files to and from your computer substantially faster compared to phone mode. However, in file transfer mode Microsoft® Windows® Explorer will only show the memory card (if inserted).

- ! *Do not remove the USB cable from your phone or computer during file transfer as this may cause a loss of data.*

To use file transfer mode

- 1 Connect the USB cable to your phone and computer.
- 2 **Phone:** Select **File transfer**.

- 3 **Computer:** Wait until the memory card appears as an external disk, "PHONE CARD", in Windows Explorer.
- 4 Use Windows Explorer as usual to transfer files between phone and computer.

To disconnect the phone safely from your computer

- 1 **Computer:** Right-click the removable disk icon in Windows Explorer and select *Eject*.
- 2 **Phone:** Remove the USB cable from your phone.

Phone mode

In phone mode you can use your computer to synchronize contacts and calendar items, transfer files, use the phone as a modem and more. Applications supported in phone mode include:

- Synchronization
- File Manager
- Mobile Networking Wizard
- Backup Manager
- Download Language
- Application Installer

To use phone mode

- 1 **Computer:** Install the PC Suite for Sony Ericsson software.

- 2 Select *Start/Programs/Sony Ericsson/PC Suite for Sony Ericsson*. The application starts.
- 3 Connect the USB cable to your phone and computer.
- 4 **Phone:** Select **Phone mode**.
- 5 **Computer:** Wait while Windows installs the required drivers.

! *All phone mode applications are marked with green in PC Suite. Only synchronization is described here. For other applications, see PC Suite in the Web guide.*

Synchronization

To synchronize your phone using PC Suite

- 1 Connect the USB cable to your phone and computer.
- 2 **Phone:** Select **Phone mode**.
- 3 **Computer:** Start PC Suite.
- 4 Wait until your phone is connected, that is, the *Synchronize Now* button turns green.
- 5 When you have made all the synchronization settings, click *Synchronize Now*.

Bluetooth connection

To turn on Bluetooth connection

- 1 From Standby select **Main menu > Settings > Connectivity > Bluetooth.**
- 2 Select the Settings tab  and mark the **Bluetooth On** check box.

Pairing

For all tasks, except for a single file transfer, it is necessary to set up a permanent and trusted relationship between your phone and the other device. This is called pairing (or bonding).

To pair with another Bluetooth device

- 1 From Standby select **Main menu > Settings > Connectivity > Bluetooth.**
- 2 Select the Devices tab  > **New device.**
- 3 Select the device in the list.
- 4 If you are asked to, enter the passcode (also called passkey).

Connections manager

Connections manager is where you control your Internet connections. You can open and

close connections, and you can reset the logs for the connections.

To open Connections manager

- From Standby select **Main menu > Organizer > Connections mgr.**

To reset logs

- 1 From Standby select **Main menu > Organizer > Connections mgr.**
- 2 Select the log you want to reset.
- 3 Select **More > Reset log.**

Wap push

To set up your phone to handle incoming WAP push messages

- 1 From Standby select **Main menu > Settings > Messaging > WAP push.**
- 2 Select **Automatically** to receive Wap push service loading messages without being prompted.

Certificate manager and Java certificates

Digital certificates are used to verify the origin of the Web pages you visit or any software you install.

***To view user and CA certificates
in your phone***

- From Standby select **Main menu > Settings > Security > Certificate manager.**



***To view Java certificates in your
phone***

- From Standby select **Main menu > Settings > Security > Java certificates.**

More features

Managing files and applications

File manager

With File manager you can view, rename, copy, move and delete files and folders in the phone memory and on the memory card. The File manager view has two tabs – the  tab for the phone memory and the  tab for the memory card.

To open File manager

- From Standby select **Main menu > Organizer > File manager.**

Protected files

Downloaded or received files may be copyright-protected. Copyright-protection may prevent content from being copied, modified or transferred. If a file is copyright-protected  is displayed next to the file name. If the key symbol is crossed the file has no valid licence, for example, the licence may have expired or there is a pending licence for the file.

Transferring files from a computer

You can access a memory card in the phone as a USB mass storage device from a computer. This way you can browse the memory card folders and transfer files to them.

Launching media files

You can launch media files directly from **File manager** by selecting them.

Renaming memory cards

You can rename the memory card.

To rename a memory card

- 1 From Standby select **Main menu > Organizer > File manager.**
- 2 Select **More > Device > Format Memory Stick > Rename.**

Formatting memory cards

- ! *All information on the memory card will be deleted during formatting.*

To format a memory card

- 1 From Standby select **Main menu > Organizer > File manager.**
- 2 Select **More > Device > Format Memory Stick > Format.**

Installing applications

Install applications and other content you use often, for example, ringtones in the phone memory since the memory card is sometimes unavailable when the phone is connected to a computer.

 In **Main menu > Entertainment > More applications** there are links to additional applications for your phone. Some of the applications are free of charge or free to try out.

To install an application

- 1 From Standby select **Main menu > Settings > General > Install**.
- 2 Select the application and choose **Details** to view information about the certificate.
- 3 If the certificate details are OK, select **Install** and follow the instructions in the phone. The application is installed in the **Entertainment** folder.

Removing applications

Sometimes it is necessary to remove installed applications to free up storage space.

To remove an application

- 1 From Standby select **Main menu > Settings > General > Uninstall**.
- 2 Select the application and select **Uninstall > Yes**.

Master reset

 All user data, as well as preinstalled media files (including, for example, backgrounds, ringtones and pictures), will be deleted and factory settings restored.

 If you back up your user data using PC Suite for Sony Ericsson, you can restore it after a master reset.

To reset the phone

- 1 From Standby select **Main menu > Settings > General > Master reset**.
- 2 If you want to keep installed applications, unmark **Delete all user installed applications**.
- 3 Select **Delete > Yes**.
- 4 Enter the phone lock code and select **Done**.

Power save

To save power, you can set the display to go blank after a period of inactivity.

To enable power save

- 1 From Standby select **Main menu > Settings > Display > Backlight.**
- 2 Mark the **Power save enabled** check box.

Screen saver

You can use a picture as a screen saver.

To set a screen saver

- From Standby select **Main menu > Settings > Display > Screen saver.**
- Select **Open** and choose a type.

Important information

Sony Ericsson Consumer Web site

On www.sonyericsson.com/ *support* there is a support section where help and tips are only a few clicks away. Here you will find the latest computer software updates and tips on how to use your phone more efficiently.

Service and support

You have access to a portfolio of exclusive service advantages such as:

- Global and local Web sites providing support
- A global network of Call Centers
- An extensive network of Sony Ericsson service partners
- A warranty period. Learn more about the warranty conditions in this User guide.

On www.sonyericsson.com you will find the latest support tools and information. For operator-specific services and features, please contact your network operator.

You can also contact our Call Centers. If your country/region is not represented in the list below, please contact your local dealer. (Calls are charged according to national rates, including local taxes, unless the phone number is a toll-free number.)

If your product needs service, please contact the dealer from whom it was purchased, or one of our service partners. For warranty claims, save proof of purchase.

Country	Phone number
Argentina	800-333-7427
Australia	1-300 650 050
Austria	0810 200245
Belgium	02-7451611
Brazil	4001-0444
Canada	1-866-766-9374
Central Africa	+27 112589023
Chile	123-0020-0656
China	4008100000
Colombia	18009122135
Croatia	062 000 000
Czech Republic	844 550 055
Denmark	33 31 28 28
Finland	09-299 2000
France	0 825 383 383
Germany	0180 534 2020

Email address

questions.AR@support.sonyericsson.com
questions.AU@support.sonyericsson.com
questions.AT@support.sonyericsson.com
questions.BE@support.sonyericsson.com
questions.BR@support.sonyericsson.com
questions.CA@support.sonyericsson.com
questions.CF@support.sonyericsson.com
questions.CL@support.sonyericsson.com
questions.CN@support.sonyericsson.com
questions.CO@support.sonyericsson.com
questions.HR@support.sonyericsson.com
questions.CZ@support.sonyericsson.com
questions.DK@support.sonyericsson.com
questions.FI@support.sonyericsson.com
questions.FR@support.sonyericsson.com
questions.DE@support.sonyericsson.com

Greece	801-11-810-810 210-89 91 919 (from mobile phone)	questions.GR@support.sonyericsson.com
Hong Kong	8203 8863	questions.HK@support.sonyericsson.com
Hungary	+36 1 880 4747	questions.HU@support.sonyericsson.com
India	1800 11 1800 (toll free number) 39011111 (from mobile phone)	questions.IN@support.sonyericsson.com
Indonesia	021-2701388	questions.ID@support.sonyericsson.com
Ireland	1850 545 888	questions.IE@support.sonyericsson.com
Italy	06 48895206	questions.IT@support.sonyericsson.com
Lithuania	8 700 55030	questions.LT@support.sonyericsson.com
Malaysia	1-800-889900	questions.MY@support.sonyericsson.com
Mexico	01 800 000 4722	questions.MX@support.sonyericsson.com
Netherlands	0900 899 8318	questions.NL@support.sonyericsson.com
New Zealand	0800-100150	questions.NZ@support.sonyericsson.com
Norway	815 00 840	questions.NO@support.sonyericsson.com
Pakistan	111 22 55 73 Outside Karachi: (92-21) 111 22 55 73	questions.PK@support.sonyericsson.com
Philippines	+63 (02) 7891860	questions.PH@support.sonyericsson.com
Poland	0 (prefix) 22 6916200	questions.PL@support.sonyericsson.com
Portugal	808 204 466	questions.PT@support.sonyericsson.com
Romania	(+4021) 401 0401	questions.RO@support.sonyericsson.com
Russia	8(495) 787 0986	questions.RU@support.sonyericsson.com
Singapore	67440733	questions.SG@support.sonyericsson.com
Slovakia	02-5443 6443	questions.SK@support.sonyericsson.com
South Africa	0861 632222	questions.ZA@support.sonyericsson.com
Spain	902 180 576	questions.ES@support.sonyericsson.com
Sweden	013-24 45 00	questions.SE@support.sonyericsson.com
Switzerland	0848 824 040	questions.CH@support.sonyericsson.com
Taiwan	02-25625511	questions.TW@support.sonyericsson.com
Thailand	02-2483030	questions.TH@support.sonyericsson.com
Turkey	0212 473 77 71	questions.TR@support.sonyericsson.com
Ukraine	(+380) 44 590 1515	questions.UA@support.sonyericsson.com
United Arab Emirates	43 919880	questions.AE@support.sonyericsson.com
United Kingdom	08705 23 7237	questions.GB@support.sonyericsson.com
United States	1-866-766-9374	questions.US@support.sonyericsson.com
Venezuela	0-800-100-2250	questions.VE@support.sonyericsson.com

Guidelines for Safe and Efficient Use

Please follow these guidelines. Failure to do so might entail a potential health risk or product malfunction. If in doubt as to its proper function, have the product checked by a certified service partner before charging or using it.



Recommendations for care and safe use of our products

- Handle with care and keep in a clean and dust-free place.
- **Warning!** May explode if disposed of in fire.
- Do not expose your product to liquid or moisture or excess humidity.
- Do not expose to extreme temperatures. Do not expose the battery to temperatures above +60°C (+140°F).
- Do not expose to flames or lit tobacco products.
- Do not drop, throw or try to bend your product.
- Do not paint or attempt to disassemble or modify your product. Only Sony Ericsson authorized personnel should perform service.
- Consult with authorized medical staff and the instructions of the medical device manufacturer before using your product near pacemakers or other medical devices or equipment.
- Discontinue use of electronic devices or disable the radio transmitting functionality of the device where required or requested to do so.
- Do not use where a potentially explosive atmosphere exists.



- Do not place your product or install wireless equipment in the area above an air bag in your car.
- **Caution:** Cracked or broken displays may create sharp edges or splinters that could be harmful upon contact.
- Do not use your Bluetooth Headset in positions where it is uncomfortable or will be subject to pressure.

Children

Warning! Keep out of the reach of children. Do not allow children to play with mobile phones or accessories. They could hurt themselves or others. Products may contain small parts that could become detached and create a choking hazard.



Power supply (Charger)

Connect the charger to power sources as marked on the product. Do not use outdoors or in damp areas. Do not alter or subject the cord to damage or stress. Unplug the unit before cleaning it. Never alter the plug. If it does not fit into the outlet, have a proper outlet installed by an electrician. When power supply is connected there is a small drain of power. To avoid this small energy waste, disconnect the power supply when the product is fully charged.

Use of charging devices that are not Sony Ericsson branded may impose increased safety risks.

Battery

New or idle batteries can have short-term reduced capacity. Fully charge the battery before initial use. Use for intended purpose only. Charge the battery in temperatures between +5°C (+41°F) and +45°C (+113°F). Do not put the battery into your mouth. Do not let the battery contacts touch another metal object. Turn off the product before removing the battery. Performance depends on temperatures, signal strength, usage patterns, features selected

and voice or data transmissions. Only Sony Ericsson service partners should remove or replace built-in batteries. Use of batteries that are not Sony Ericsson branded may pose increased safety risks.

Personal medical devices

Mobile phones may affect implanted medical equipment. Reduce risk of interference by keeping a minimum distance of 15 cm (6 inches) between the phone and the device. Use the phone at your right ear. Do not carry the phone in your breast pocket. Turn off the phone if you suspect interference. For all medical devices, consult a physician and the manufacturer.

Driving

Some vehicle manufacturers forbid the use of phones in their vehicles unless a handsfree kit with an external antenna supports the installation. Check with your vehicle manufacturer's representative to be sure that your mobile phone or Bluetooth handsfree will not affect the electronic systems in your vehicle. Full attention should be given to driving at all times and local laws and regulations restricting the use of wireless devices while driving must be observed.

GPS/Location based functions

Some products provide GPS/Location based functions. Location determining functionality is provided "As is" and "With all faults". Sony Ericsson does not make any representation or warranty as to the accuracy of such location information.

Use of location-based information by the device may not be uninterrupted or error free and may additionally be dependent on network service availability. Please note that functionality may be reduced or prevented in certain environments such as building interiors or areas adjacent to buildings.

Caution: Do not use GPS functionality in a manner which causes distraction from driving.

Emergency calls

Calls cannot be guaranteed under all conditions. Never rely solely upon mobile phones for essential communications. Calls may not be possible in all areas, on all networks, or when certain network services and/or phone features are used.

Antenna

Use of antenna devices not marketed by Sony Ericsson could damage your phone, reduce performance, and produce SAR levels above the established limits. Do not cover the antenna with your hand as this affects call quality, power levels and can shorten talk and standby times.

Radio frequency (RF) exposure and Specific Absorption Rate (SAR)

When your phone or Bluetooth handsfree is turned on, it emits low levels of radio frequency energy. International safety guidelines have been developed through periodic and thorough evaluation of scientific studies. These guidelines establish permitted levels of radio wave exposure. The guidelines include a safety margin designed to assure the safety of all persons and to account for any variations in measurements.

Specific Absorption Rate (SAR) is used to measure radio frequency energy absorbed by the body when using a mobile phone. The SAR value is determined at the highest certified power level in laboratory conditions, but because the phone is designed to use the minimum power necessary to access the chosen network, the actual SAR level can be well below this value. There is no proof of difference in safety based on difference in SAR value.

Products with radio transmitters sold in the US must be certified by the Federal Communications Commission (FCC). When required, tests are performed when the phone is placed at the ear and when worn on the body. For body-worn operation, the phone has been tested when positioned a minimum of 15 mm from the body without any metal parts in the vicinity of the phone or when properly used with an appropriate Sony Ericsson accessory and worn on the body.

For more information about SAR and radio frequency exposure go to: www.sonyericsson.com/help.

Malware

Malware (short for malicious software) is software that can harm your mobile phone or other computers. Malware or harmful applications can include viruses, worms, spyware, and other unwanted programs. While your device does employ security measures to resist such efforts, Sony Ericsson does not warrant or represent that your device will be impervious to introduction of malware. You can however reduce the risk of malware attacks by using care when downloading content or accepting applications, refraining from opening or responding to messages from unknown sources, using trustworthy services to access the Internet, and only downloading content to your mobile phone from known, reliable sources.

Accessories

Use only Sony Ericsson branded original accessories and certified service partners. Sony Ericsson does not test third-party accessories. Accessories may influence RF Exposure, radio performance, sound loudness, electric safety and other areas. Third-party accessories and parts may pose a risk to your health or safety or decrease performance.

Accessible Solutions/Special Needs

In the US, compatible Sony Ericsson phones may offer compatibility with TTY terminals (with use of necessary accessory). For more information call the Sony Ericsson Special Needs Center on 877 878 1996 (TTY) or 877 207 2056 (voice), or go to www.sonyericsson-snc.com.

Disposal of old electrical and electronic equipment

Electronic equipment and batteries should not be included as household waste but should be left at an appropriate collection point for recycling. This helps prevent potential negative consequences for the environment and human health. Check local regulations by contacting your local city office, your household waste disposal service, the shop where you purchased the product or calling a Sony Ericsson Call Center.



Disposing of the battery

Check local regulations or call a Sony Ericsson Call Center for information. Never use municipal waste.



Memory Card

If your product comes complete with a removable memory card, it is generally compatible with the mobile phone purchased but may not be compatible with other devices or the capabilities of their memory cards. Check other devices for compatibility before purchase or use. If your product is equipped with a memory card reader, check memory card compatibility before purchase or use.

Memory cards are generally formatted prior to shipping. To reformat the memory card, use a

compatible device. Do not use the standard operating system format when formatting the memory card on a PC. For details, refer to the operating instructions of the device or contact customer support.

Warning!

If your device requires an adapter for insertion into the mobile phone or another device, do not insert the card directly without the required adapter.

Precautions on Memory Card Use

- Do not expose the memory card to moisture.
- Do not touch terminal connections with your hand or any metal object.
- Do not strike, bend, or drop the memory card.
- Do not attempt to disassemble or modify the memory card.
- Do not use or store the memory card in humid or corrosive locations or in excessive heat such as a closed car in summer, in direct sunlight or near a heater, etc.
- Do not press or bend the end of the memory card adapter with excessive force.
- Do not let dust or foreign objects get into the insert port of any memory card adapter.
- Check you have inserted the memory card correctly.
- Insert the memory card as far as it will go into any memory card adapter needed. The memory card may not operate properly unless fully inserted.
- We recommend that you make a backup copy of important data. We are not responsible for any loss or damage to content you store on the memory card.
- Recorded data may be damaged or lost when you remove the memory card or memory card adapter, or turn off the power while formatting, reading or writing data, or when you use the memory card in

locations subject to static electricity or high electrical field emissions.

Protection of personal information

Erase personal data before disposing of the product. To delete data, perform a master reset. Deleting data from the phone memory does not ensure that it cannot be recovered. Sony Ericsson does not warrant against recovery of information and does not assume responsibility for disclosure of any information even after a master reset.

Loudness warning!

Avoid volume levels that may be harmful to your hearing.

End User Licence Agreement

Software delivered with this device and its media is owned by Sony Ericsson Mobile Communications AB, and/or its affiliated companies and its suppliers and licensors.

Sony Ericsson grants you a non-exclusive limited license to use the Software solely in conjunction with the Device on which it is installed or delivered. Ownership of the Software is not sold, transferred or otherwise conveyed.

Do not use any means to discover the source code or any component of the Software, reproduce and distribute the Software, or modify the Software. You are entitled to transfer rights and obligations to the Software to a third party, solely together with the Device with which you received the Software, provided the third party agrees in writing to be bound by the terms of this License.

This license exists throughout the useful life of this Device. It can be terminated by transferring your rights to the Device to a third party in writing.

Failure to comply with any of these terms and conditions will terminate the license immediately.

Sony Ericsson and its third party suppliers and licensors retain all rights, title and interest in and to the Software. Sony Ericsson, and, to the extent that the Software contains material or code of a third party, such third party, shall be entitled third party beneficiaries of these terms.

This license is governed by the laws of Sweden. When applicable, the foregoing applies to statutory consumer rights.

In the event Software accompanying or provided in conjunction with your device is provided with additional terms and conditions, such provisions shall also govern your possession and usage of the Software.

Limited warranty

Sony Ericsson Mobile Communications AB, Nya Vattentorget, SE-221 88 Lund, Sweden (Sony Ericsson), or its local affiliated company, provides this Limited Warranty for your mobile phone, original accessory delivered with your mobile phone, and/or your mobile computing product (hereinafter referred to as "Product").

Should your Product need warranty service, please return it to the dealer from whom it was purchased, or contact your local Sony Ericsson Call Center (national rates may apply) or visit www.sonyericsson.com to get further information.

Our warranty

Subject to the conditions of this Limited Warranty, Sony Ericsson warrants this Product to be free from defects in design, material and workmanship at the time of its original purchase by a consumer. This Limited Warranty will last for a for a period of two (2) years as from the original date of purchase of the Product for your mobile phone, and for a period of one (1) year following the original purchase date of the Product for all original accessories (such as the battery, charger or handsfree kit) which may be delivered with your mobile phone.

What we will do

If, during the warranty period, this Product fails to operate under normal use and service, due to defects in design, materials or workmanship, Sony Ericsson authorized distributors or service partners, in the country* where you purchased the Product, will, at their option, either repair or replace the Product in accordance with the terms and conditions stipulated herein.

Sony Ericsson and its service partners reserve the right to charge a handling fee if a returned Product is found not to be under warranty according to the conditions below.

Please note that some of your personal settings, downloads and other information may be lost when your Sony Ericsson Product is repaired or replaced. At present Sony Ericsson may be prevented by applicable law, other regulation or technical restrictions from making a backup copy of certain downloads. Sony Ericsson does not take any responsibility for any lost information of any kind and will not reimburse you for any such loss. You should always make backup copies of all the information stored on your Sony Ericsson Product such as downloads, calendar and contacts before handing in your Sony Ericsson Product for repair or replacement.

Conditions

- 1 This Limited Warranty is valid only if the original proof of purchase for this Product issued by a Sony Ericsson authorized dealer specifying the date of purchase and serial number**, is presented with the Product to be repaired or replaced. Sony Ericsson reserves the right to refuse warranty service if this information has been removed or changed after the original purchase of the Product from the dealer.
- 2 If Sony Ericsson repairs or replaces the Product, the repair for the defect concerned, or the replaced Product shall be warranted for the remaining time of the original warranty period or for ninety (90)

days from the date of repair, whichever is longer. Repair or replacement may involve the use of functionally equivalent reconditioned units. Replaced parts or components will become the property of Sony Ericsson.

- 3 This warranty does not cover any failure of the Product due to normal tear and wear, or due to misuse, including but not limited to use in other than the normal and customary manner, in accordance with the Sony Ericsson instructions for use and maintenance of the Product. Nor does this warranty cover any failure of the Product due to accident, software or hardware modification or adjustment, acts of God or damage resulting from liquid.

A rechargeable battery can be charged and discharged more than a hundred times. However, it will eventually wear out – this is not a defect and corresponds to normal wear and tear. When the talk-time or standby time is noticeably shorter, it is time to replace your battery. Sony Ericsson recommends that you use only batteries and chargers approved by Sony Ericsson.

Minor variations in display brightness and colour may occur between the phones. There may be tiny bright or dark dots on the display. These are called defective pixels and occur when individual dots have malfunctioned and can not be adjusted. Two defective pixels are deemed acceptable.

Minor variations in camera image appearance may occur between phones. This is nothing uncommon and is not regarded as a defective camera module.

- 4 Since the cellular system on which the Product is to operate is provided by a carrier independent from Sony Ericsson, Sony Ericsson will not be responsible for the operation, availability, coverage, services or range of that system.
- 5 This warranty does not cover Product failures caused by installations, modifications, or repair or opening of the Product performed by a non-Sony Ericsson authorised person.

- 6 The warranty does not cover Product failures which have been caused by use of accessories or other peripheral devices which are not Sony Ericsson branded original accessories intended for use with the Product.
- 7 Tampering with any of the seals on the Product will void the warranty.
- 8 THERE ARE NO EXPRESS WARRANTIES, WHETHER WRITTEN OR ORAL, OTHER THAN THIS PRINTED LIMITED WARRANTY. ALL IMPLIED WARRANTIES, INCLUDING WITHOUT LIMITATION THE IMPLIED WARRANTIES OF MERCHANTABILITY OR FITNESS FOR A PARTICULAR PURPOSE, ARE LIMITED TO THE DURATION OF THIS LIMITED WARRANTY. IN NO EVENT SHALL SONY ERICSSON OR ITS LICENSORS BE LIABLE FOR INCIDENTAL OR CONSEQUENTIAL DAMAGES OF ANY NATURE WHATSOEVER, INCLUDING BUT NOT LIMITED TO LOST PROFITS OR COMMERCIAL LOSS; TO THE FULL EXTENT THOSE DAMAGES CAN BE DISCLAIMED BY LAW.

Some countries/states do not allow the exclusion or limitation of incidental or consequential damages, or limitation of the duration of implied warranties, so the preceding limitations or exclusions may not apply to you.

The warranty provided does not affect the consumer's statutory rights under applicable legislation in force, nor the consumer's rights against the dealer arising from their sales / purchase contract.

***Geographical scope of the warranty**

If you have purchased your Product in a country member of the European Economic Area (EEA) or in Switzerland or the Republic of Turkey, and such Product was intended for sale in the EEA or in Switzerland or in Turkey, you can have your Product serviced in any EEA country or in

Switzerland or in Turkey, under the warranty conditions prevailing in the country in which you require servicing, provided that an identical Product is sold in such country by an authorised Sony Ericsson distributor. To find out if your Product is sold in the country you are in, please call the local Sony Ericsson Call Center. Please observe that certain services may not be possible elsewhere than in the country of original purchase, for example due to the fact that your Product may have an interior or exterior which is different from equivalent models sold in other countries. Please note in addition that it may sometimes not be possible to repair SIM-locked Products.

** In some countries/regions additional information (such as a valid warranty card) may be requested.

FCC Statement

This device complies with Part 15 of the FCC rules. Operation is subject to the following two conditions:



(1) This device may not cause harmful interference, and (2) This device must accept any interference received, including interference that may cause undesired operation.

Any change or modification not expressly approved by Sony Ericsson may void the user's authority to operate the equipment.

This equipment has been tested and found to comply with the limits for a Class B digital device, pursuant to Part 15 of the FCC Rules. These limits are designed to provide reasonable protection against harmful interference in a residential installation. This equipment generates, uses and can radiate radio frequency energy and, if not installed and used in accordance with the instructions, may cause harmful interference to radio communications. However, there is no

guarantee that interference will not occur in a particular installation.

If this equipment does cause harmful interference to radio or television reception, which can be determined by turning the equipment off and on, the user is encouraged to try to correct the interference by one or more of the following measures:

- Reorient or relocate the receiving antenna.
- Increase the separation between the equipment and receiver.
- Connect the equipment into an outlet on a circuit different from that to which the receiver is connected.
- Consult the dealer or an experienced radio/TV technician for help.

Industry Canada Statement

This device complies with RSS-210 of Industry Canada.

Operation is subject to the following two conditions: (1) this device may not cause interference, and (2) this device must accept any interference, including interference that may cause undesired operation of the device.

This Class B digital apparatus complies with Canadian ICES-003.

Cet appareil numérique de la classe B est conforme à la norme NMB-003 du Canada.

Declaration of Conformity for G700

We, **Sony Ericsson Mobile Communications AB** of
Nya Vattentorget

SE-221 88 Lund, Sweden

declare under our sole responsibility that our
product

Sony Ericsson type FAD-3022018-BV

and in combination with our accessories, to which
this declaration relates is in conformity with the
appropriate standards EN 301 511:V9.0.2, EN 301
908-1:V2.2.1, EN 301 908-2:V2.2.1, EN 300
328:V1.7.1, EN 301 489-7:V1.3.1, EN 301 489-
17:V1.2.1, EN 301 489-24:V1.3.1 and EN 60950-
1:2006, following the provisions of, Radio
Equipment and Telecommunication Terminal
Equipment Directive 1999/5/EC.

Lund, February 2008

CE 0682



Shoji Nemoto,
Head of Product Business Group GSM/UMTS

We fulfil the requirements of the R&TTE Directive
(1999/5/EC).

Index

B

Backup of phone data	51
Battery	9
Blog	40
Bluetooth™ wireless technology ..	53

C

Call log	28
Camera	45
Certificates	53
Connections manager	53
Contacts	29

E

Email	35
Emergency call	26

F

File manager	55
File transfer mode	51
Flight mode	13
FM radio	48
Folders in messaging	32

H

Handsfree settings	28
Handwriting recognition	22

I

IMEI number	11
Import contacts	19
Installing applications	56
International call	25
Internet browser	39
Internet wizard	11

K

Keylock	11
Keypad prediction	22

M

Main menu	15
overview	17
Master reset	56
Memory card	19
Messaging	32
MMS	33
Music	43
My words dictionary	24

N

Navigation	14
Notes	20

O

On/off	13
--------------	----

On-screen keyboard	24	Synchronization	52
P		T	
Pairing	53	Text	21
Panels	14	Torch	21
PC Suite	51	TrackID™	50
Photo		Transferring files	51
take	45	U	
view	41	Update software	16
Picture editor	42	Updating software	16
PlayNow™	48	USB file transfer	51
Power save	56	V	
Protected files	55	Video	
Push email	37	capture	45
R		play	44
RSS feeds	40	Video calls	27
S		W	
Screen saver	57	Wap push	53
Silent mode	19	Web feeds	40
SIM card	9	Web guide	5
Slide show	42		
SMS	33		
Sounds and alerts	19		
Speed dial	25		
Standby	14		
Status bar	18		
Symbols	23		